Sup/IRBuck™

USER GUIDE FOR IR3856W Dual Sided EVALUATION BOARD

DESCRIPTION

The IR3856W is a synchronous buck converter, providing a compact, high performance and flexible solution in a small 4mmx5mm Power QFN package.

Key features offered by the IR3856W include programmable soft-start ramp, precision 0.7V reference voltage, Power Good, thermal protection, programmable switching frequency, Sequence input, Enable input, input under-voltage lockout for proper start-up, and pre-bias start-up.

An output over-current protection function is implemented by sensing the voltage developed across the on-resistance of the synchronous rectifier MOSFET for optimum cost and performance.

This user guide contains the schematic and bill of materials for the IR3856W evaluation board. The guide describes operation and use of the evaluation board itself. Detailed application information for IR3856W is available in the IR3856W data sheet.

BOARD FEATURES

- $V_{in} = +12V (+ 13.2V \text{ Max})$
- $V_{cc} = +5V (5.5V \text{ Max})$
- $V_{out} = +1.8V @ 0- 6A$
- $F_s = 600kHz$
- $L = 1.0uH$
- $C_{in} = 2x10uF$ (ceramic 1206)
- $C_{out} = 4x22uF$ (ceramic 0805)
- Small footprint of design (16mmx8mm)

CONNECTIONS and OPERATING INSTRUCTIONS

A well regulated +12V input supply should be connected to VIN+ and VIN-. A maximum 6A load should be connected to VOUT+ and VOUT-. The connection diagram is shown in Fig. 1 and inputs and outputs of the board are listed in Table I.

IR3856W has two input supplies, one for biasing (Vcc) and the other as input voltage (Vin). Separate supplies should be applied to these inputs. Vcc input should be a well regulated 4.5V-5.5V supply and it would be connected to Vcc+ and Vcc-.

The output can track a sequencing input at the start-up. *For sequencing application, R16 should be removed and the external sequencing source should be applied between Seq. and Agnd.* External Enable signal can be applied to the board via exposed Enable pad and *R18 should be removed for this purpose. For proper operation of IR3856W, the voltage at Seq. and Enable should always be kept below Vcc.*

Table I. Connections

Connection	Signal Name
VIN+	V_{in} (+12V)
VIN-	Ground of V_{in}
Vcc+	Vcc input
Vcc-	Ground for Vcc input
VOUT-	Ground of V_{out}
VOUT+	V_{out} (+1.8V)
Enable	Enable
Seq.	Sequence Input
P_Good	Power Good Signal

LAYOUT

The PCB is a 4-layer board. All of layers are 2 Oz. copper. The IR3856W SupIRBuck and input capacitors and some of the passive components are mounted on the top side of the board. The output caps, inductor, and the rest of passive components are located on the bottom side of the board. The total footprint of the design is 16mmx8mm, which is very compact.

Power supply decoupling capacitors, the Bootstrap capacitor and feedback components are located close to IR3856W. The feedback resistors are connected to the output voltage at the point of regulation and are located close to the SupIRBuck. To improve efficiency, the circuit board is designed to minimize the length of the on-board power ground current path.

Connection Diagram

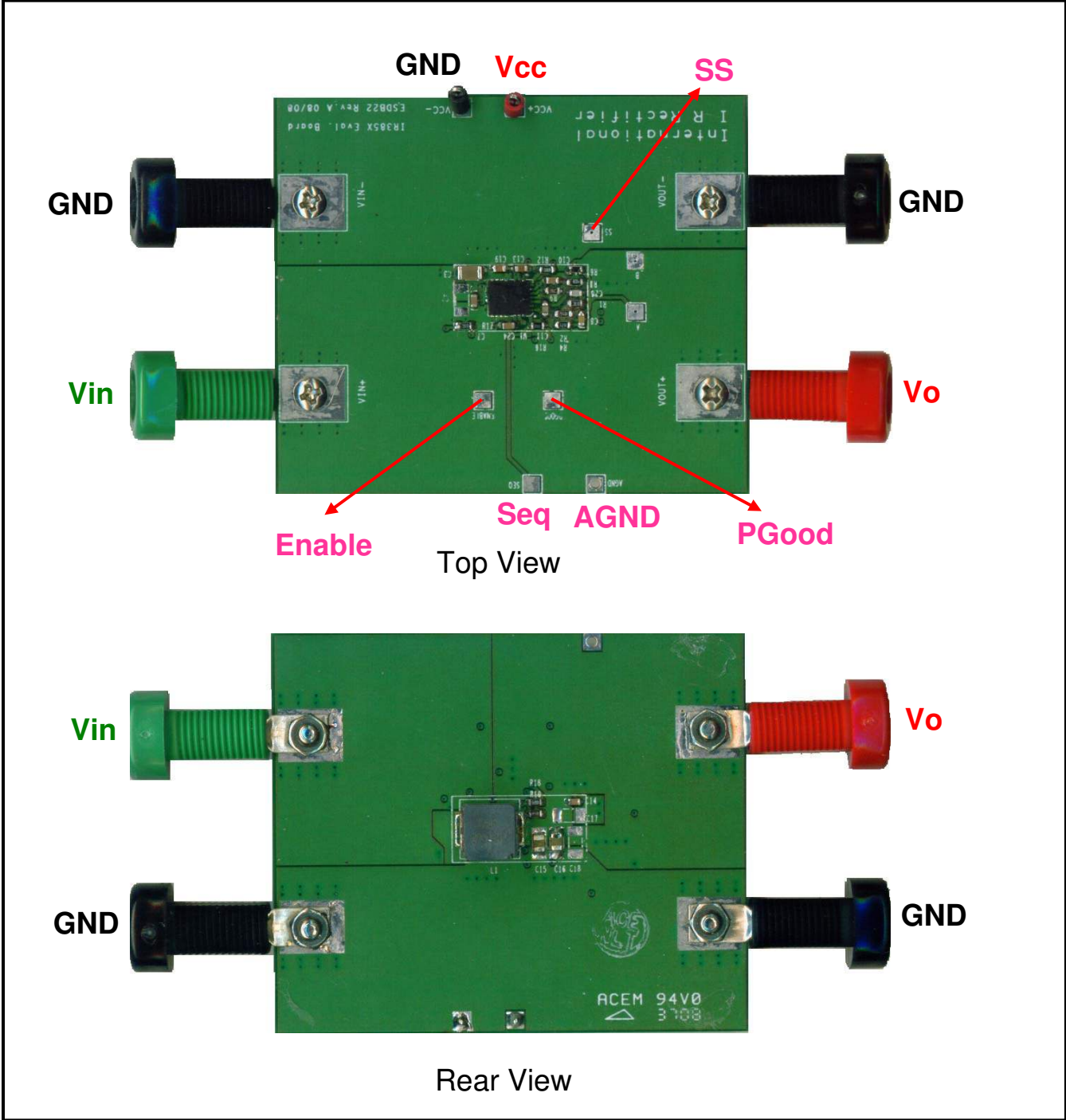

Fig. 1: Connection diagram of IR3856W evaluation board

Bill of Materials

Item	Quantity	Part Reference	Value	Description	Manufacturer	Part Number
1	2	C2, C3	10uF	1206, 16V, X5R, 20%	Panasonic - ECG	ECJ-3YB1C106M
2	4	C7 C14 C24 C10	0.1uF	0603, 25V, X7R, 10%	Panasonic - ECG	ECJ-1VB1E104K
3	1	C8	2200pF	0603, 50V, X7R, 10%	Panasonic - ECG	ECJ-2VB2D222K
4	1	C11	220pF	50V, 0603, NP0, 5%	Murata	GRM1885C1H221JA01D
5	4	C15 C16 C17 C18	22uF	0805, 6.3V, X5R, 20%	Panasonic - ECG	ECJ-2FB0J226M
6	1	C26	10000pF	0603, 50V, X7R, 10%	Panasonic - ECG	ECJ-1VB1H103K
7	2	C13 C19	1uF	0603, 10V, X5R, 10%	Panasonic - ECG	ECJ-BVB1A105K
8	1	L1	1.0uH	7.0mmx6.6mmx4.8mm, 5.6mOhm, 20%	Cyntec	PCMB065T-1R0MS
9	1	R2	4.02K	0603,1/10W,1%	Rohm	MCR03EZPFX4021
10	1	R3	2.55K	0603,1/10W,1%	Rohm	MCR03EZPFX2551
11	1	R4	130	0603,1/10W,1%	Panasonic - ECG	ERJ-3EKF1300V
12	1	R6	20	0603,1/10 W,1%	Vishey/Dale	CRCW060320R0FKEA
13	1	R9	23.7k	0603,1/10W,1%	Rohm	MCR03EZPFX2372
14	1	R16	0	0603,1/10 W,5%	Vishay/Dale	CRCW06030000Z0EA
15	1	R17	10.0k	0603,1/10 W,1%	Rohm	MCR03EZPFX1002
16	1	R18	49.9k	0603,1/10 W,1%	Rohm	MCR03EZPFX4992
17	1	R19	7.50k	0603,1/10W,1%	Rohm	MCR03EZPFX7501
18	1	U1	IR3856W	PQFN 4x5mm, 6A, SupIRBuck	International Rectifier	IR3856WMPbF
19	1	R1	2.05k	0603,1/10W,1%	Rohm	MCR03EZPFX2051
20	1	R12	2.8k	0603,1/10W,1%	Rohm	MCR03EZPFX2801

TYPICAL OPERATING WAVEFORMS

$V_{in}=12.0V$, $V_{cc}=5V$, $V_o=1.8V$, $I_o=0-6A$, Room Temperature, No Air Flow

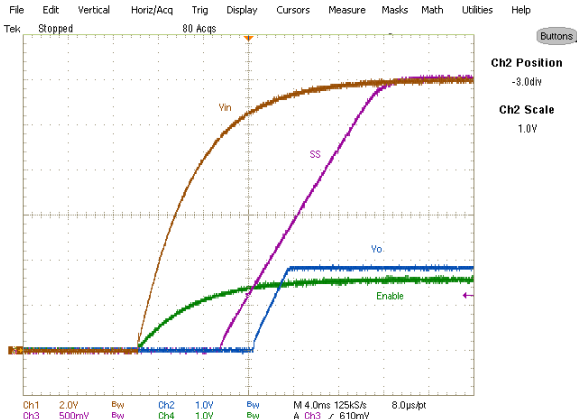

Fig. 3: Start up at 6A Load
Ch₁:V_{in}, Ch₂:V_o, Ch₃:V_{ss}, Ch₄:Enable

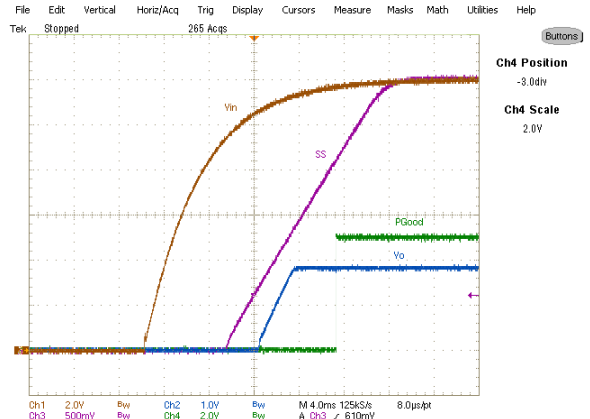

Fig. 4: Start up at 6A Load,
Ch₁:V_{in}, Ch₂:V_o, Ch₃:V_{ss}, Ch₄:V_{PGood}

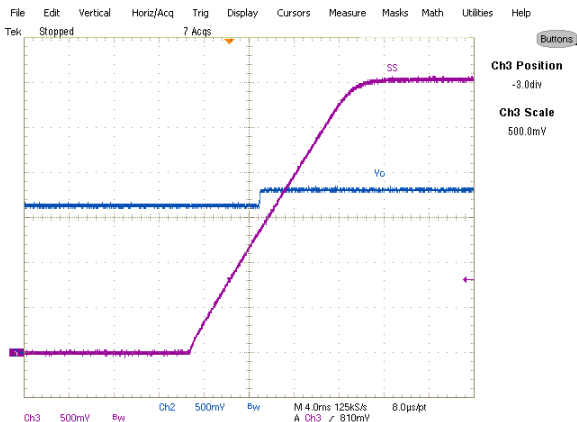

Fig. 5: Start up with Pre Bias, 0A Load,
Ch₂:V_o, Ch₃:V_{ss}

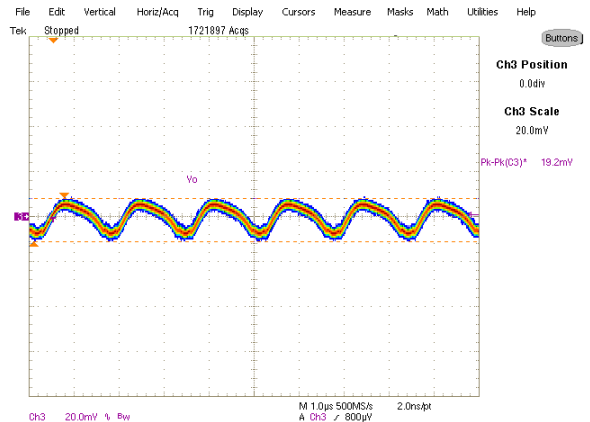

Fig. 6: Output Voltage Ripple, 6A load
Ch₃:V_{out}

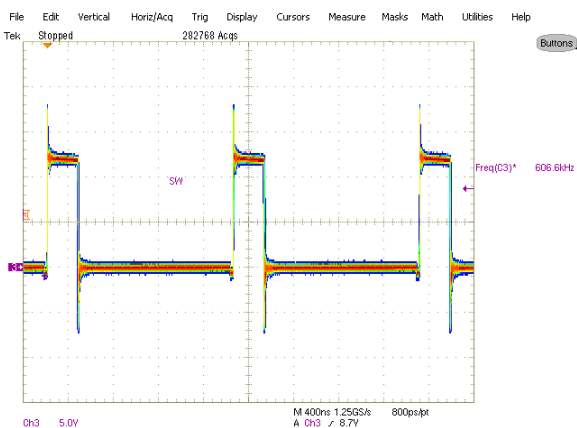

Fig. 7: Inductor node at 6A load
Ch₃:LX

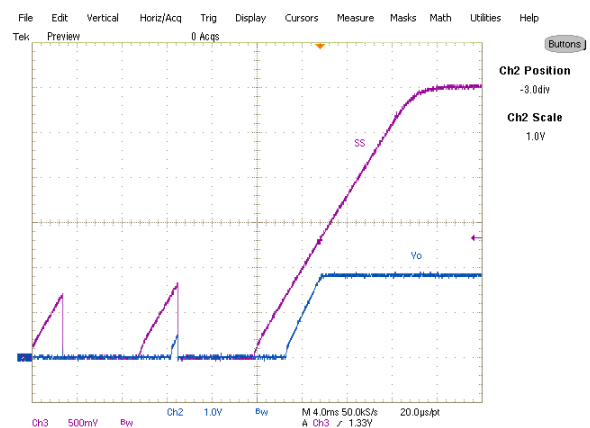

Fig. 8: Short (Hiccup) Recovery
Ch₂:V_{out}, Ch₃:V_{ss}

TYPICAL OPERATING WAVEFORMS

$V_{in}=12V$, $V_{cc}=5V$, $V_o=1.8V$, $I_o=0-6A$, Room Temperature, No Air Flow

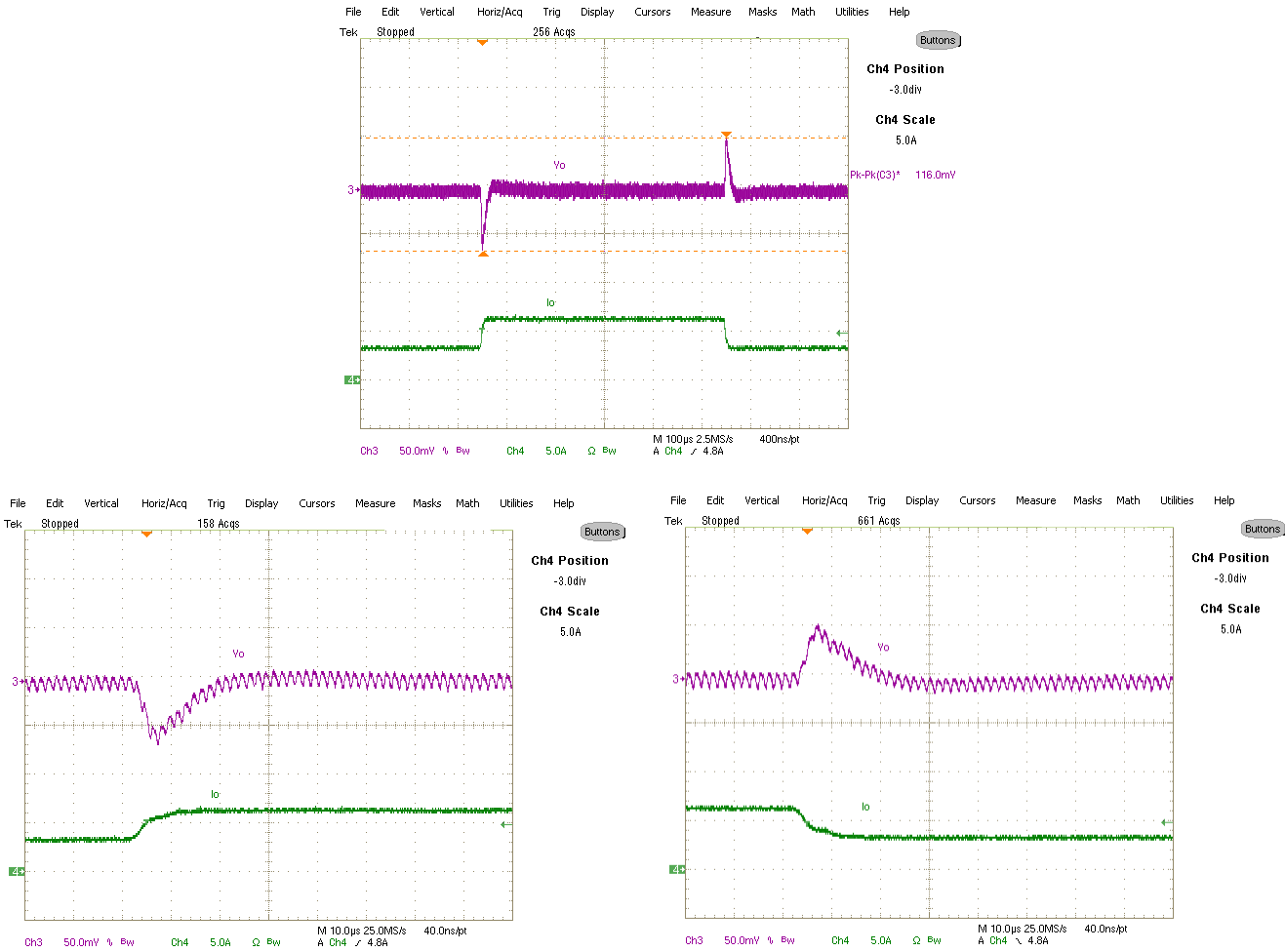

Fig. 9: Transient Response, 3A to 6A step (2.5A/us)
Ch₃:V_{out}, Ch₄:I_{out}

TYPICAL OPERATING WAVEFORMS

Vin=12V, Vcc=5V, Vo=1.8V, Io=6A, Room Temperature, No Air Flow

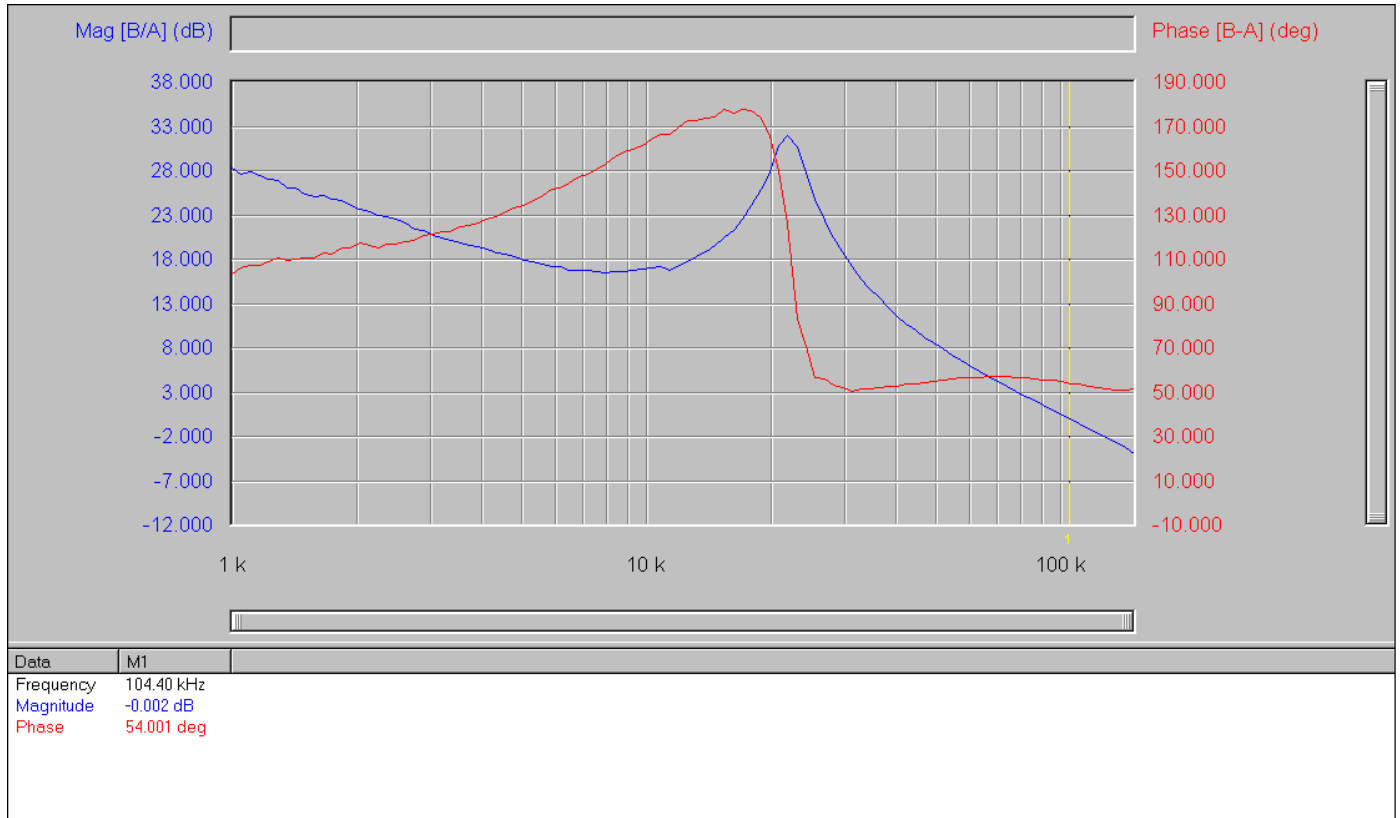

Fig. 10: Bode Plot at 6A load shows a bandwidth of 104kHz and phase margin of 54 degrees

TYPICAL OPERATING WAVEFORMS

Vin=12V, Vo=1.8V, Io=0- 6A, Room Temperature, No Air Flow

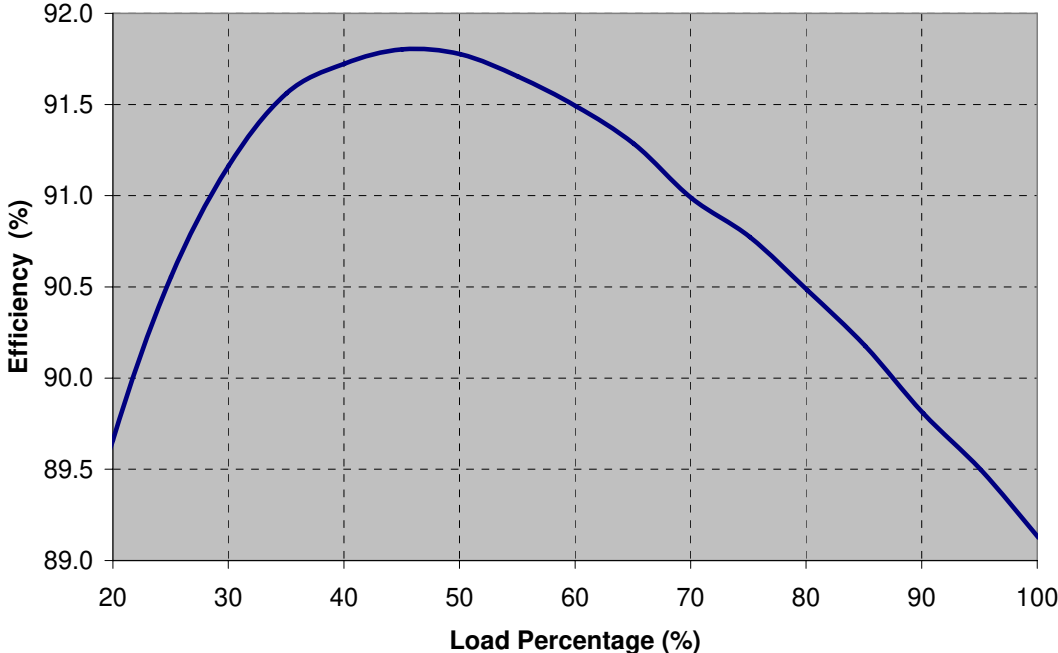

Fig.11: Efficiency versus load current

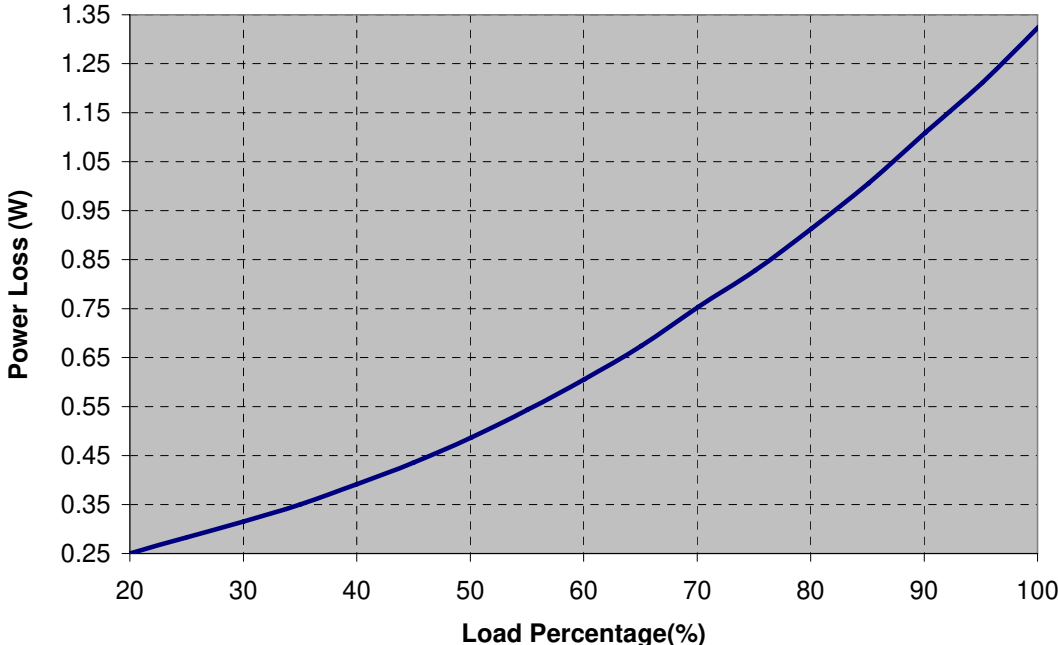

Fig.12: Power loss versus load current

THERMAL IMAGES

Vin=12V, Vo=1.8V, Io=6A, Room Temperature, No Air Flow

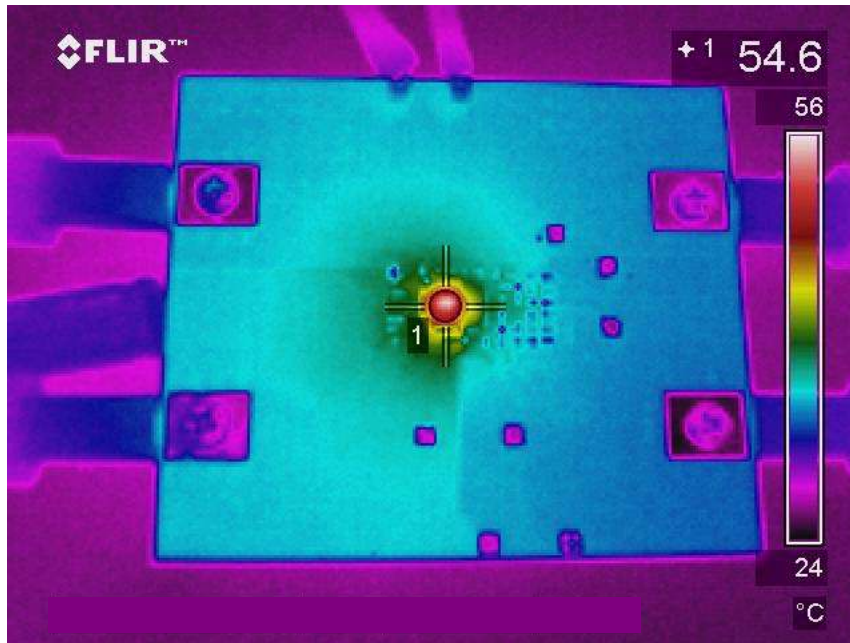

Fig. 13: Thermal Image of Top side of the board at 6A load
Test points 1 is IR3856W

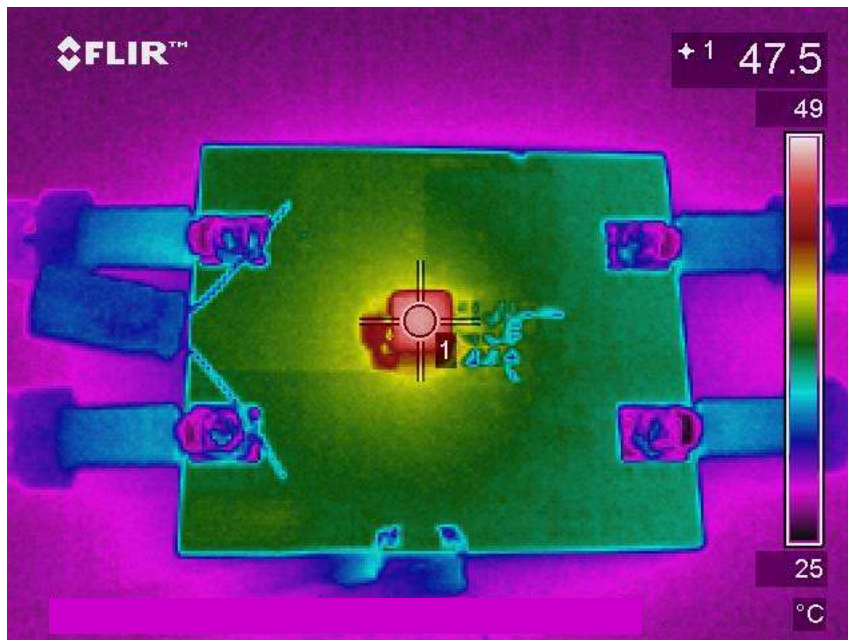

Fig. 14: Thermal Image of Rear side of the board at 6A load
Test points 1 is Inductor