

L0806BR82JSWST

Aliases (L0806BR82JSWST)

Not for New Design

KEMET, L-SWS, Commercial Grade, 0.82 uH, 5%

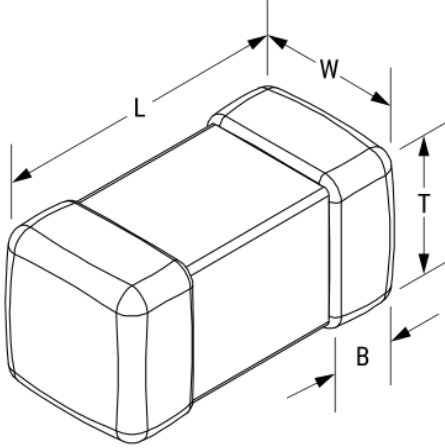

Click [here](#) for the 3D model.

General Information

Series	L-SWS
Style	SMD Chip
RoHS	Yes
Notes	Last Order Date June 30, 2023.

Specifications

Inductance	0.82 uH
Inductance Tolerance	5%
Temperature Range	-40/+105°C
Current	390 mAmps (MAX)
DC Resistance	0.34 Ohms
Self-Resonant Frequency	250 MHz MIN

Dimensions

Chip Size	0806
L	2mm +/-0.2mm
W	1.6mm +/-0.2mm
T	1.6mm +/-0.2mm
B	0.5mm +/-0.2mm

Packaging Specifications

Packaging	T&R
Packaging Quantity	2000

Statements of suitability for certain applications are based on our knowledge of typical operating conditions for such applications, but are not intended to constitute - and we specifically disclaim - any warranty concerning suitability for a specific customer application or use. This information is intended for use only by customers who have the requisite experience and capability to determine the correct products for their application. Any technical advice inferred from this information or otherwise provided by us with reference to the use of our products is given gratis, and we assume no obligation or liability for the advice given or results obtained.