

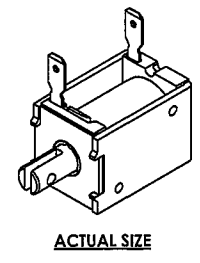

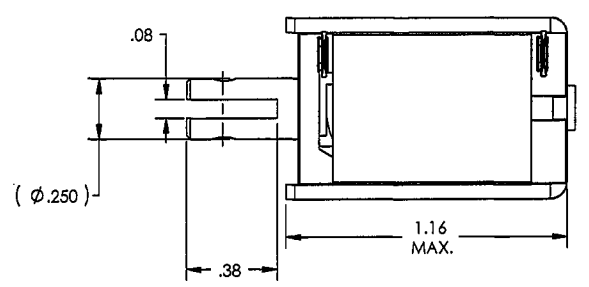

REVISIONS					
REV	BY	ECN	DESCRIPTION	DATE	APPD
A	RCH	04-018	RELEASE FOR PRODUCTION	8/20/04	RCH
B	RCH	05-032	135.0 WAS 144.0	3/09/06	RCH
C	RCH	15-002	ADD F0415A AND F0416A	1/29/15	RCH

PART NO.	DESCRIPTION	OHMS ± 10% @ 25°C	DIGI-KEY NO.
F0411A	L-22PL012D-C	36.0	527-1000-ND
F0412A	L-22PL012D-I	16.9	527-1001-ND
F0413A	L-22PL024D-C	135.0	527-1002-ND
F0414A	L-22PL024D-I	68.0	527-1003-ND
F0415A	L-22PL012D-P	3.6	TBD
F0416A	L-22PL024D-P	14.0	TBD

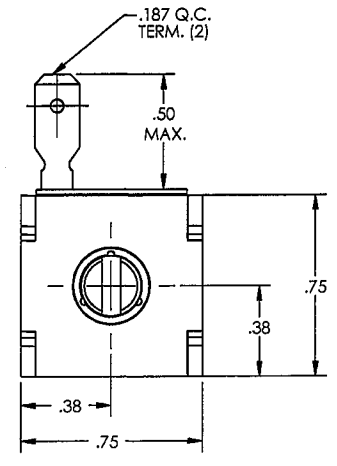
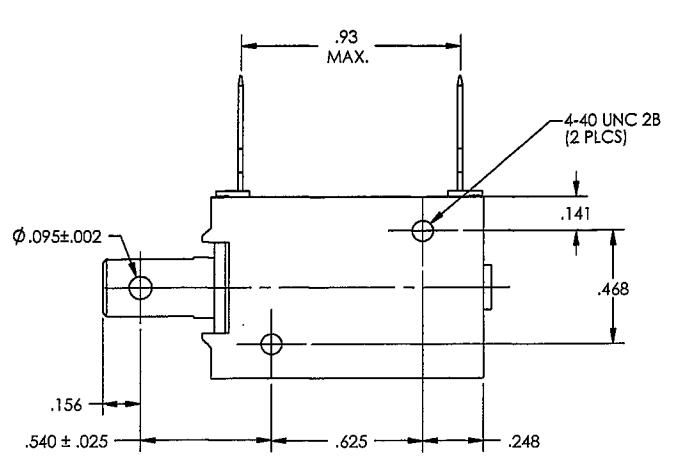

LABEL INFO:
 PONTIAC COIL, INC.
(PART NO.) (DATECODE)
(DESCRIPTION)

UNLESS OTHERWISE SPECIFIED		MATERIAL: SEE BOM PRINTS		 PONTIAC COIL, INC.	
ALL DIMENSIONS ARE IN INCHES DIMENSIONS IN [] ARE MILLIMETERS		FINISH PLATING: SEE BOM PRINTS		TITLE: CUSTOMER DRAWING	
TOLERANCES:		INDUSTRY ASSY:		L22	
X(D)	± .1	THIS DOCUMENT IS THE PROPERTY OF PONTIAC COIL, INC. AND ALL CONTENTS ARE PROPRIETARY.		FILE NAME	CD-F041XA.SLDDRW
XXX (XXX)	± .01			SIZE	B
XXXX (XXXX)	± .005	DO NOT SCALE DRAWING		DWG NO.	CD-F041XA
XXXXX (XXXXX)	± .0005	FULL FILE NAME: E:\DWG\SPCS\CD-F041XA.SLDDRW		CUSTOMER	DIGI-KEY
FRACTIONS	± 1/32			CUSTOMER P/N	
ANGLES IN DEGREE	± 2°			SCALE	2=1
				AWCCODE	
				SHEET 1 OF 1	