

8 A, 400 V - 600 V, Ultrafast Diodes

Description

The MUR840, MUR860, RURP840, RURP860 is an ultrafast diode with low forward voltage drop. This device is intended for use as freewheeling and clamping diodes in a variety of switching power supplies and other power switching applications. It is specially suited for use in switching power supplies and industrial application.

Ordering Information

PART NUMBER	PACKAGE	BRAND
MUR840	TO-220AC-2L	MUR840
RURP840	TO-220AC-2L	RURP840
MUR860	TO-220AC-2L	MUR860
RURP860	TO-220AC-2L	RURP860

NOTE: When ordering, use the entire part number.

Symbol



Features

- Ultrafast Recovery $t_{rr} = 70$ ns (@ $I_F = 8$ A)
- Max Forward Voltage, $V_F = 1.5$ V (@ $T_C = 25^\circ\text{C}$)
- 400 V, 600 V Reverse Voltage and High Reliability
- Avalanche Energy Rated
- RoHS Compliant

Applications

- Switching Power Supplies
- Power Switching Circuits
- General Purpose

Packaging



Absolute Maximum Ratings $T_C = 25^\circ\text{C}$, Unless Otherwise Specified

	MUR840 RURP840	MUR860 RURP860	UNIT
Peak Repetitive Reverse Voltage	400	600	V
Working Peak Reverse Voltage	400	600	V
DC Blocking Voltage	400	600	V
Average Rectified Forward Current ($T_C = 155^\circ\text{C}$)	8	8	A
Repetitive Peak Surge Current (Square Wave, 20kHz)	16	16	A
Nonrepetitive Peak Surge Current (Halfwave, 1 Phase, 60Hz)	100	100	A
Maximum Power Dissipation	75	75	W
Avalanche Energy (See Figures 10 and 11)	20	20	mJ
Operating and Storage Temperature	-65 to 175	-65 to 175	$^\circ\text{C}$
Maximum Lead Temperature for Soldering			
Leads at 0.063 in. (1.6mm) from case for 10s	300	300	$^\circ\text{C}$
Package Body for 10s, see Tech Brief 334.	260	260	$^\circ\text{C}$

MUR840, MUR860, RURP840, RURP860

Electrical Specifications $T_C = 25^\circ\text{C}$, Unless Otherwise Specified

SYMBOL	TEST CONDITION	MUR840, RURP840			MUR860, RURP860			UNIT
		MIN	TYP	MAX	MIN	TYP	MAX	
V_F	$I_F = 8\text{ A}$	-	-	1.3	-	-	1.5	V
	$I_F = 8\text{ A}, T_C = 150^\circ\text{C}$	-	-	1.0	-	-	1.2	V
I_R	$V_R = 400\text{ V}$	-	-	100	-	-	-	μA
	$V_R = 600\text{ V}$	-	-	-	-	-	100	μA
	$V_R = 400\text{ V}, T_C = 150^\circ\text{C}$	-	-	500	-	-	-	μA
	$V_R = 600\text{ V}, T_C = 150^\circ\text{C}$	-	-	-	-	-	500	μA
t_{rr}	$I_F = 1\text{ A}, dI_F/dt = 200\text{ A}/\mu\text{s}$	-	-	60	-	-	60	ns
	$I_F = 8\text{ A}, dI_F/dt = 200\text{ A}/\mu\text{s}$	-	-	70	-	-	70	ns
t_a	$I_F = 8\text{ A}, dI_F/dt = 200\text{ A}/\mu\text{s}$	-	32	-	-	32	-	ns
t_b	$I_F = 8\text{ A}, dI_F/dt = 200\text{ A}/\mu\text{s}$	-	21	-	-	21	-	ns
Q_{rr}	$I_F = 8\text{ A}, dI_F/dt = 200\text{ A}/\mu\text{s}$	-	195	-	-	195	-	nC
C_J	$V_R = 10\text{ V}, I_F = 0\text{ A}$	-	25	-	-	25	-	pF
$R_{\theta JC}$		-	-	2	-	-	2	$^\circ\text{C}/\text{W}$

DEFINITIONS

V_F = Instantaneous forward voltage (pw = 300 μs , D = 2%).

I_R = Instantaneous reverse current.

T_{rr} = Reverse recovery time (See Figure 9), summation of $t_a + t_b$.

t_a = Time to reach peak reverse current (See Figure 9).

t_b = Time from peak I_{RM} to projected zero crossing of I_{RM} based on a straight line from peak I_{RM} through 25% of I_{RM} (See Figure 9).

Q_{rr} = Reverse recovery charge.

C_J = Junction Capacitance.

$R_{\theta JC}$ = Thermal resistance junction to case.

pw = pulse width.

D = duty cycle.

Typical Performance Curves

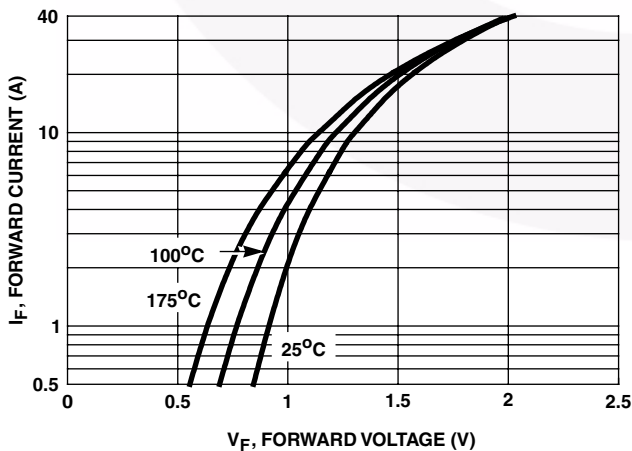

FIGURE 1. FORWARD CURRENT vs FORWARD VOLTAGE

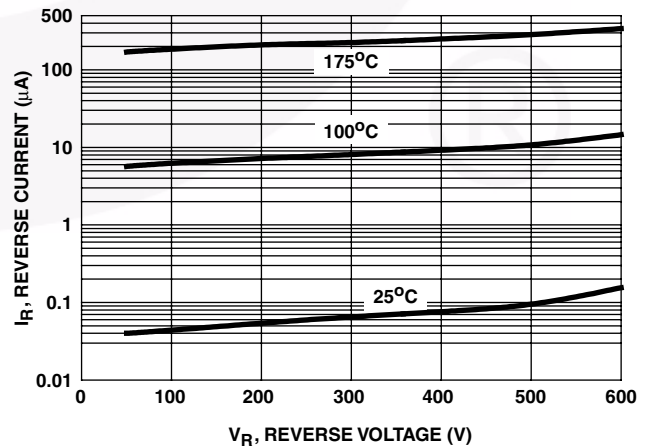

FIGURE 2. REVERSE CURRENT vs REVERSE VOLTAGE

Typical Performance Curves (Continued)

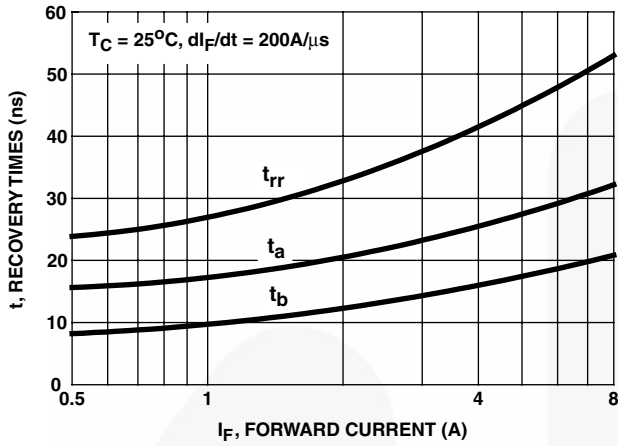

FIGURE 3. t_{rr} , t_a AND t_b CURVES vs FORWARD CURRENT

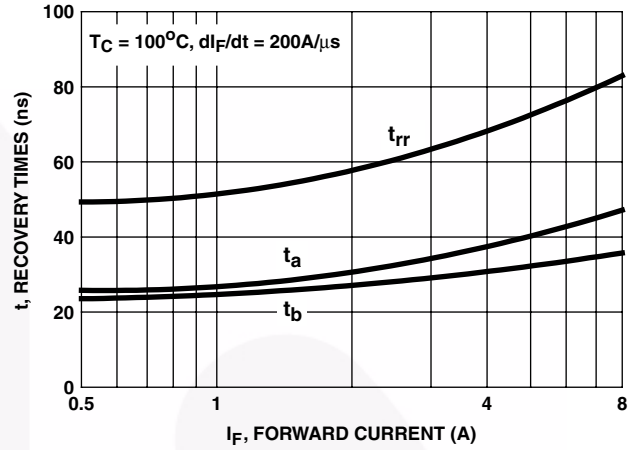

FIGURE 4. t_{rr} , t_a AND t_b CURVES vs FORWARD CURRENT

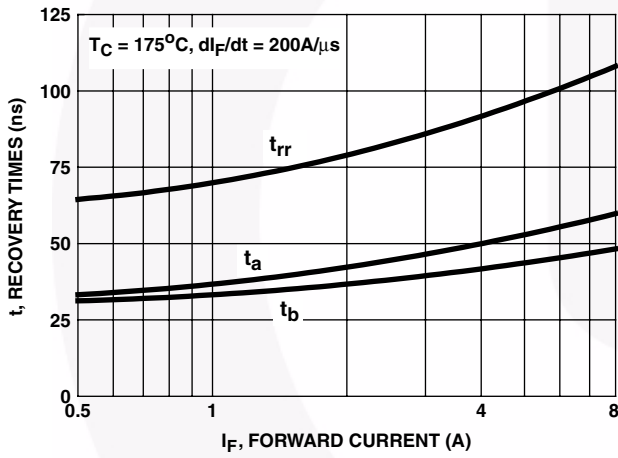

FIGURE 5. t_{rr} , t_a AND t_b CURVES vs FORWARD CURRENT

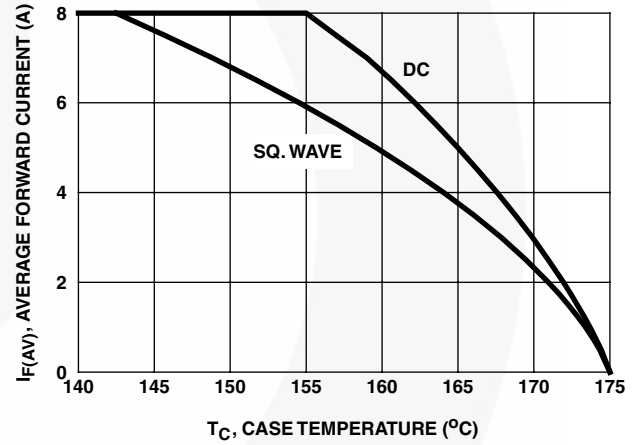

FIGURE 6. CURRENT DERATING CURVE

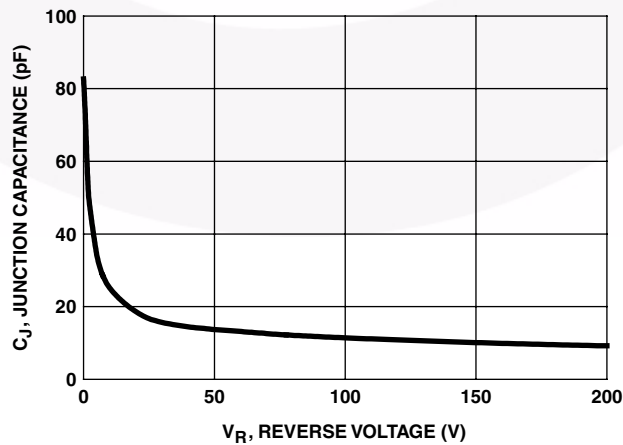

FIGURE 7. JUNCTION CAPACITANCE vs REVERSE VOLTAGE

Test Circuits and Waveforms

V_{GE} AMPLITUDE AND
 R_G CONTROL di_F/dt
 t_1 AND t_2 CONTROL I_F

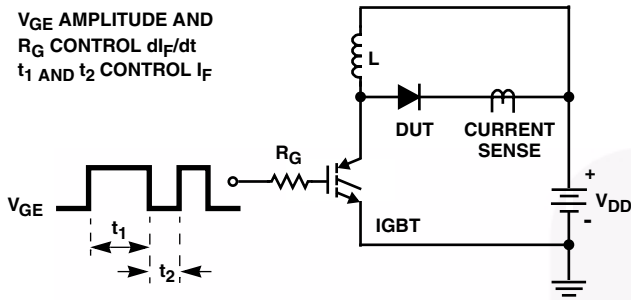

FIGURE 8. t_{rr} TEST CIRCUIT

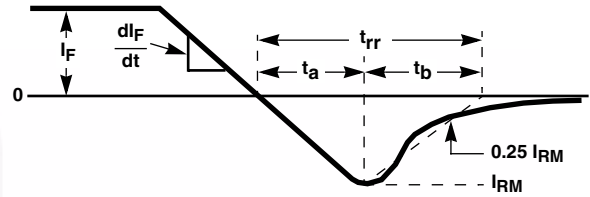

FIGURE 9. t_{rr} WAVEFORMS AND DEFINITIONS

$I = 1A$
 $L = 40mH$
 $R < 0.1\Omega$
 $E_{AVL} = 1/2LI^2 [V_{R(AVL)}/(V_{R(AVL)} - V_{DD})]$
 $Q_1 = IGBT (BV_{CES} > DUT V_{R(AVL)})$

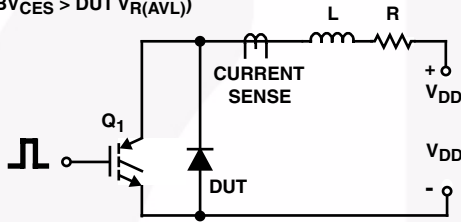

FIGURE 10. AVALANCHE ENERGY TEST CIRCUIT

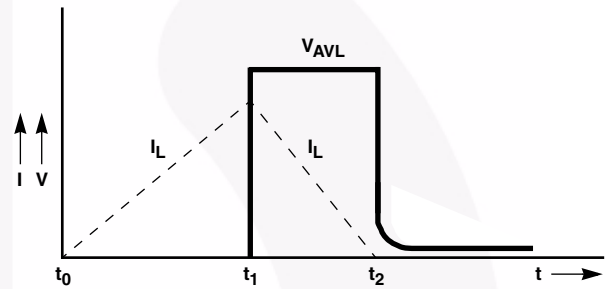
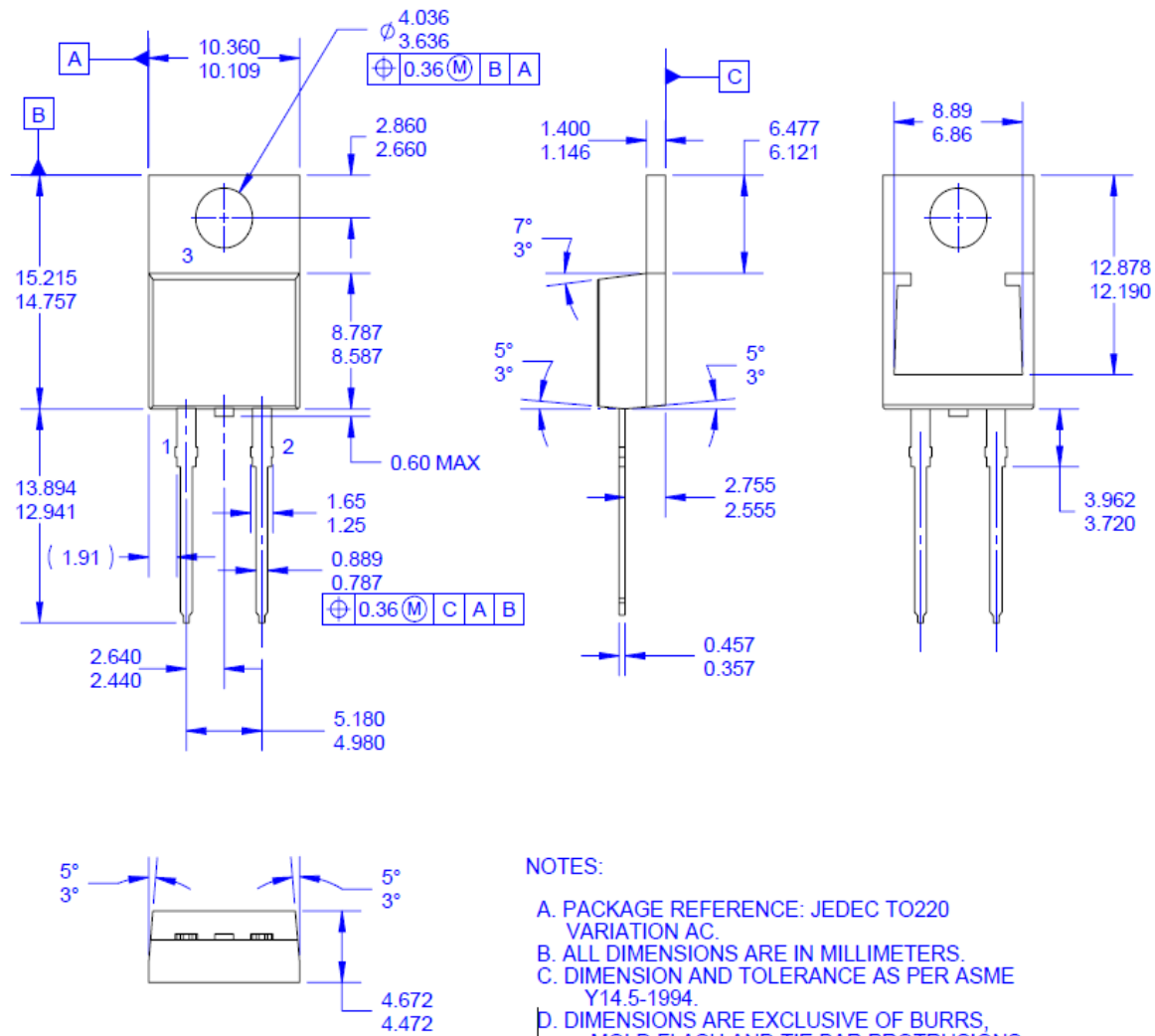

FIGURE 11. AVALANCHE CURRENT AND VOLTAGE WAVEFORMS

Mechanical Dimensions



NOTES:

- A. PACKAGE REFERENCE: JEDEC TO220 VARIATION AC.
- B. ALL DIMENSIONS ARE IN MILLIMETERS.
- C. DIMENSION AND TOLERANCE AS PER ASME Y14.5-1994.
- D. DIMENSIONS ARE EXCLUSIVE OF BURRS, MOLD FLASH AND TIE BAR PROTRUSIONS.
- E. THIS PACKAGE IS FSSZ INTERNAL PRODUCTION AND INTENDED FOR DELTA CUSTOMER ONLY.
- F. DRAWING FILE NAME: TO220B02REV4

Figure 12. TO-220 2L - TO-220, MOLDED, 2LD

Package drawings are provided as a service to customers considering Fairchild components. Drawings may change in any manner without notice. Please note the revision and/or date on the drawing and contact a Fairchild Semiconductor representative to verify or obtain the most recent revision. Package specifications do not expand the terms of Fairchild's worldwide terms and conditions, specifically the warranty therein, which covers Fairchild products.

Always visit Fairchild Semiconductor's online packaging area for the most recent package drawings:

http://www.fairchildsemi.com/package/packageDetails.html?id=PN_TT220-002



TRADEMARKS

The following includes registered and unregistered trademarks and service marks, owned by Fairchild Semiconductor and/or its global subsidiaries, and is not intended to be an exhaustive list of all such trademarks.

- | | | | |
|---|---|---------------------------------------|------------------|
| AccuPower™ | F-PFST™ | PowerTrench® | Sync-Lock™ |
| AX-CAP®* | FRFET® | PowerXS™ | SYSTEM GENERAL®* |
| BitSiC™ | Global Power ResourceSM | Programmable Active Droop™ | TinyBoost® |
| Build it Now™ | GreenBridge™ | QFET® | TinyBuck® |
| CorePLUS™ | Green FPS™ | QS™ | TinyCalc™ |
| CorePOWER™ | Green FPS™ e-Series™ | Quiet Series™ | TinyLogic® |
| CROSSVOLT™ | Gmax™ | RapidConfigure™ | TINYOPTO™ |
| CTL™ | GTO™ | Saving our world, 1mW/W/kW at a time™ | TinyPower™ |
| Current Transfer Logic™ | IntelliMAX™ | SignalWise™ | TinyPWM™ |
| DEUXPEED® | ISOPLANAR™ | SmartMax™ | TinyWire™ |
| Dual Cool™ | Marking Small Speakers Sound Louder and Better™ | SMART START™ | TranSiC™ |
| EcoSPARK® | MegaBuck™ | Solutions for Your Success™ | TriFault Detect™ |
| EfficientMax™ | MICROCOUPLER™ | SPM® | TRUECURRENT®* |
| ESBC™ | MicroFET™ | STEALTH™ | µSerDes™ |
|  | MicroPak™ | SuperFET® | UHC® |
| Fairchild® | MicroPak2™ | SuperSOT™-3 | Ultra FRFET™ |
| Fairchild Semiconductor® | MillerDrive™ | SuperSOT™-6 | UniFET™ |
| FACT Quiet Series™ | MotionMax™ | SuperSOT™-8 | VCX™ |
| FACT® | mWSave® | SupreMOS® | VisualMax™ |
| FAST® | OptoHit™ | SyncFET™ | VoltagePlus™ |
| FastvCore™ | OPTOLOGIC® | | XS™ |
| FETBench™ | OPTOPLANAR® | | |
| FPS™ | | | |

*Trademarks of System General Corporation, used under license by Fairchild Semiconductor.

DISCLAIMER

FAIRCHILD SEMICONDUCTOR RESERVES THE RIGHT TO MAKE CHANGES WITHOUT FURTHER NOTICE TO ANY PRODUCTS HEREIN TO IMPROVE RELIABILITY, FUNCTION, OR DESIGN. FAIRCHILD DOES NOT ASSUME ANY LIABILITY ARISING OUT OF THE APPLICATION OR USE OF ANY PRODUCT OR CIRCUIT DESCRIBED HEREIN; NEITHER DOES IT CONVEY ANY LICENSE UNDER ITS PATENT RIGHTS, NOR THE RIGHTS OF OTHERS. THESE SPECIFICATIONS DO NOT EXPAND THE TERMS OF FAIRCHILD'S WORLDWIDE TERMS AND CONDITIONS, SPECIFICALLY THE WARRANTY THEREIN, WHICH COVERS THESE PRODUCTS.

LIFE SUPPORT POLICY

FAIRCHILD'S PRODUCTS ARE NOT AUTHORIZED FOR USE AS CRITICAL COMPONENTS IN LIFE SUPPORT DEVICES OR SYSTEMS WITHOUT THE EXPRESS WRITTEN APPROVAL OF FAIRCHILD SEMICONDUCTOR CORPORATION.

As used here in:

- Life support devices or systems are devices or systems which, (a) are intended for surgical implant into the body or (b) support or sustain life, and (c) whose failure to perform when properly used in accordance with instructions for use provided in the labeling, can be reasonably expected to result in a significant injury of the user.
- A critical component in any component of a life support, device, or system whose failure to perform can be reasonably expected to cause the failure of the life support device or system, or to affect its safety or effectiveness.

ANTI-COUNTERFEITING POLICY

Fairchild Semiconductor Corporation's Anti-Counterfeiting Policy. Fairchild's Anti-Counterfeiting Policy is also stated on our external website, www.Fairchildsemi.com, under Sales Support. Counterfeiting of semiconductor parts is a growing problem in the industry. All manufactures of semiconductor products are experiencing counterfeiting of their parts. Customers who inadvertently purchase counterfeit parts experience many problems such as loss of brand reputation, substandard performance, failed application, and increased cost of production and manufacturing delays. Fairchild is taking strong measures to protect ourselves and our customers from the proliferation of counterfeit parts. Fairchild strongly encourages customers to purchase Fairchild parts either directly from Fairchild or from Authorized Fairchild Distributors who are listed by country on our web page cited above. Products customers buy either from Fairchild directly or from Authorized Fairchild Distributors are genuine parts, have full traceability, meet Fairchild's quality standards for handling and storage and provide access to Fairchild's full range of up-to-date technical and product information. Fairchild and our Authorized Distributors will stand behind all warranties and will appropriately address and warranty issues that may arise. Fairchild will not provide any warranty coverage or other assistance for parts bought from Unauthorized Sources. Fairchild is committed to combat this global problem and encourage our customers to do their part in stopping this practice by buying direct or from authorized distributors.

PRODUCT STATUS DEFINITIONS
Definition of Terms

Datasheet Identification	Product Status	Definition
Advance Information	Formative / In Design	Datasheet contains the design specifications for product development. Specifications may change in any manner without notice.
Preliminary	First Production	Datasheet contains preliminary data; supplementary data will be published at a later date. Fairchild Semiconductor reserves the right to make changes at any time without notice to improve design.
No Identification Needed	Full Production	Datasheet contains final specifications. Fairchild Semiconductor reserves the right to make changes at any time without notice to improve the design.
Obsolete	Not In Production	Datasheet contains specifications on a product that is discontinued by Fairchild Semiconductor. The datasheet is for reference information only.

Rev. 166