

100315 Low-Skew Quad Clock Driver

General Description

The 100315 contains four low skew differential drivers, designed for generation of multiple, minimum skew differential clocks from a single differential input. This device also has the capability to select a secondary single-ended clock source for use in lower frequency system level testing. The 100315 is a 300 Series redesign of the 100115 clock driver.

- Differential inputs and outputs
- Small outline package (SOIC)
- Secondary clock available for system level testing
- 2000V ESD protection
- Voltage compensated operating range: -4.2V to -5.7V
- Military and industrial grades available

Features

- Low output to output skew (≤ 50 ps)

Ordering Code:

Logic Diagram

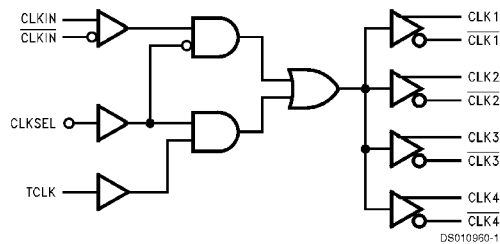

Connection Diagram

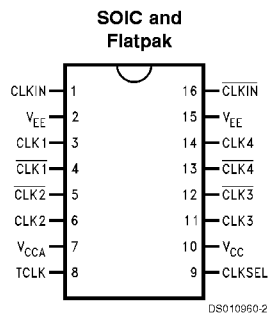

Pin Names	Description
CLKIN, $\overline{\text{CLKIN}}$	Differential Clock Inputs
CLK ₁₋₄ , $\overline{\text{CLK}}_{1-4}$	Differential Clock Outputs
TCLK	Test Clock Input (Note 1)
CLKSEL	Clock Input Select (Note 1)

Note 1: TCLK and CLKSEL are single-ended inputs, with internal 50 k Ω pull-down resistors.

Truth Table

CLKSEL	CLKIN	$\overline{\text{CLKIN}}$	TCLK	CLK _N	$\overline{\text{CLK}}_{\text{N}}$
L	L	H	X	L	H
L	H	L	X	H	L
H	X	X	L	L	H
H	X	X	H	H	L

L = Low Voltage Level
H = High Voltage Level
X = Don't Care

Absolute Maximum Ratings (Note 2)

Above which the useful life may be impaired	
Storage Temperature	-65°C to +150°C
Maximum Junction Temperature (T _J)	
Plastic	+150°C
Ceramic	+175°C
Case Temperature under Bias (T _C)	0°C to +85°C
V _{EE} Pin Potential to Ground Pin	-7.0V to +0.5V
Input Voltage (DC)	V _{CC} to +0.5V
Output Current (DC Output HIGH)	-50 mA
Operating Range (Note 2)	-5.7V to -4.2V
ESD (Note 3)	≥2000V

Recommended Operating Conditions

Case Temperature (T _C)	
Commercial	0°C to +85°C
Industrial	-40°C to +85°C
Military	-55°C to +125°C
Supply Voltage (V _{EE})	-5.7V to -4.2V

Note 2: Absolute maximum ratings are those values beyond which the device may be damaged or have its useful life impaired. Functional operation under these conditions is not implied.

Note 3: ESD testing conforms to MIL-STD-883, Method 3015.

Commercial Version DC Electrical Characteristics

V_{EE} = -4.2V to -5.7V, V_{CC} = V_{CCA} = GND, T_C = 0°C to +85°C (Note 4)

Symbol	Parameter	Min	Typ	Max	Units	Conditions
V _{OH}	Output HIGH Voltage	-1025	-955	-870	mV	V _{IN} = V _{IH(Max)} Loading with 50Ω to -2.0V
V _{OL}	Output LOW Voltage	-1830	-1705	-1620		
V _{OHc}	Output HIGH Voltage	-1035			mV	V _{IN} = V _{IH(Min)} Loading with 50Ω to -2.0V
V _{OLc}	Output LOW Voltage			-1610		
V _{IH}	Single-Ended Input HIGH Voltage	-1165		-870	mV	Guaranteed HIGH Signal for All Inputs
V _{IL}	Single-Ended Input LOW Voltage	-1830		-1475	mV	Guaranteed LOW Signal for All Inputs
I _{IL}	Input LOW Current	0.50			μA	V _{IN} = V _{IL(Min)}
I _{IH}	Input High Current CLKIN, CLKIN TCLK CLKSEL			150 250 250	μA μA μA	V _{IN} = V _{IH(Max)}
V _{DIFF}	Input Voltage Differential	150			mV	Required for Full Output Swing
V _{CM}	Common Mode Voltage	V _{CC} - 2V		V _{CC} - 0.5V	V	
I _{CBO}	Input Leakage Current	-10			μA	V _{IN} = V _{EE}
I _{EE}	Power Supply Current	-67		-35	mA	

Note 4: The specified limits represent the "worst case" value for the parameter. Since these "worst case" values normally occur at the temperature extremes, additional noise immunity and guard banding can be achieved by decreasing the allowable system operating ranges.

AC Electrical Characteristics

V_{EE} = -4.2V to -4.8, V_{CC} = V_{CCA} = GND

Symbol	Parameter	T _C = 0°C		T _C = +25°C		T _C = +85°C		Units	Conditions
		Min	Max	Min	Max	Min	Max		
f _{MAX}	Maximum Clock Frequency	750		750		750		MHz	
t _{PLH} t _{PHL}	Propagation Delay CLKIN, CLKIN to CLK ₍₁₋₄₎ , CLK ₍₁₋₄₎							ns	Figures 1, 3
	Differential	0.59	0.79	0.62	0.82	0.67	0.87		
	Single-Ended	0.59	0.99	0.62	1.02	0.67	1.07		
t _{PLH} t _{PHL}	Propagation Delay, TCLK to CLK ₍₁₋₄₎ , CLK ₍₁₋₄₎	0.50	1.20	0.50	1.20	0.50	1.20	ns	Figures 1, 2
t _{PLH} t _{PHL}	Propagation Delay, CLKSEL to CLK ₍₁₋₄₎ , CLK ₍₁₋₄₎	0.80	1.60	0.80	1.60	0.80	1.60	ns	Figures 1, 2
t _{TLH} t _{THL}	Transition Time 20% to 80%, 80% to 20%	0.30	0.80	0.30	0.80	0.30	0.80	ns	Figures 1, 4

AC Electrical Characteristics (Continued)

$V_{EE} = -4.2V$ to -4.8 , $V_{CC} = V_{CCA} = GND$

Symbol	Parameter	$T_C = 0^\circ C$		$T_C = +25^\circ C$		$T_C = +85^\circ C$		Units	Conditions
		Min	Max	Min	Max	Min	Max		
t_{OST} DIFF	Maximum Skew Opposite Edge Output-to-Output Variation Data to Output Path		50		50		50	ps	(Note 5)

Note 5: Output-to-Output Skew is defined as the absolute value of the difference between the actual propagation delay for any outputs within the same packaged device. The specifications apply to any outputs switching in the same direction either HIGH to LOW (t_{OSH}), or LOW to HIGH (t_{OLH}), or in opposite directions both HL and LH (t_{OST}). Parameters t_{OST} and t_{PS} guaranteed by design.

Industrial Version DC Electrical Characteristics

$V_{EE} = -4.2V$ to -5.7 , $V_{CC} = V_{CCA} = GND$

Symbol	Parameter	$T_C = -40^\circ C$		$T_C = 0^\circ C$ to $+85^\circ C$		Units	Conditions	
		Min	Max	Min	Max			
V_{OH}	Output HIGH Voltage	-1085	-870	-1025	-870	mV	$V_{IN} = V_{IH(Max)}$ or $V_{IL(Min)}$	Loading with 50Ω to -2.0V
V_{OL}	Output LOW Voltage	-1830	-1575	-1830	-1620	mV	$V_{IN} = V_{IH(Min)}$ or $V_{IL(Max)}$	
V_{OHC}	Output HIGH Voltage	-1095		-1035		mV	$V_{IN} = V_{IH(Max)}$ or $V_{IL(Min)}$	Loading with 50Ω to -2.0V
V_{OLC}	Output LOW Voltage		-1565		-1610	mV	$V_{IN} = V_{IH(Min)}$ or $V_{IL(Max)}$	
V_{IH}	Single-Ended Input HIGH Voltage	-1170	-870	-1165	-870	mV	Guaranteed HIGH Signal for All Inputs	
V_{IL}	Single-Ended Input LOW Voltage	-1830	-1480	-1830	-1475	mV	Guaranteed LOW Signal for All Inputs	
I_{IL}	Input LOW Current	0.50		0.50		μA	$V_{IN} = V_{IL(Min)}$	

DC Electrical Characteristics

$V_{EE} = -4.2V$ to -5.7 , $V_{CC} = V_{CCA} = GND$

Symbol	Parameter	$T_C = -40^\circ C$		$T_C = 0^\circ C$ to $+85^\circ C$		Units	Conditions	
		Min	Max	Min	Max			
I_{IH}	Input HIGH Current CLKIN, \overline{CLKIN}		107		107	μA	$V_{IN} = V_{IH(Max)}$	
	TCLK		300		300	μA		
	CLKSEL		260		260	μA		
V_{DIFF}	Input Voltage Differential	150		150		mV	Required for Full Output Swing	
V_{CM}	Common Mode Voltage	$V_{CC} - 2V$		$V_{CC} - 0.5V$		V		
I_{CBO}	Input Leakage Current	-10		-10		μA	$V_{IN} = V_{EE}$	
I_{EE}	Power Supply Current	-70	-30	-70	-30	mA		

AC Electrical Characteristics

$V_{EE} = -4.2V$ to $-5.7V$, $V_{CC} = V_{CCA} = GND$

Symbol	Parameter	$T_C = -40^\circ C$		$T_C = +25^\circ C$		$T_C = +85^\circ C$		Units	Conditions
		Min	Max	Min	Max	Min	Max		
f_{MAX}	Maximum Clock Frequency	750		750		750		MHz	

AC Electrical Characteristics (Continued)

$V_{EE} = -4.2V$ to $-5.7V$, $V_{CC} = V_{CCA} = GND$

Symbol	Parameter	$T_C = -40^\circ C$		$T_C = +25^\circ C$		$T_C = +85^\circ C$		Units	Conditions
		Min	Max	Min	Max	Min	Max		
t_{PLH} t_{PHL}	Propagation Delay \overline{CLKIN} , \overline{CLKIN} to $CLK_{(1-4)}$, $\overline{CLK}_{(1-4)}$ Differential Single-Ended	0.59	0.99	0.62	0.82	0.67	0.87	ns	Figures 1, 3
t_{PLH} t_{PHL}	Propagation Delay, \overline{TCLK} to $CLK_{(1-4)}$, $\overline{CLK}_{(1-4)}$	0.50	1.20	0.50	1.20	0.50	1.20	ns	Figures 1, 2
t_{TLH} t_{THL}	Transition Time 20% to 80%, 80% to 20%	0.30	0.80	0.30	0.80	0.30	0.80	ns	
t_{OST} DIFF	Maximum Skew Opposite Edge Output-to-Output Variation to Output Path		50		50		50	ps	(Note 6)

Note 6: Output-to-Output Skew is defined as the absolute value of the difference between the actual propagation delay for any outputs within the same package device. The specifications apply to any outputs switching in the same direction either HIGH to LOW (t_{OSHL}), or LOW to HIGH (t_{OSLH}), or in opposite directions both HL and LH (t_{OST}). Parameters t_{OST} and t_{PS} guaranteed by design.

Military Version—Preliminary DC Electrical Characteristics

$V_{EE} = -4.2V$ to $-5.7V$, $V_{CC} = V_{CCA} = GND$ (Note 9)

Symbol	Parameter	Min	Typ	Max	Units	T_C	Conditions	Notes	
V_{OH}	Output HIGH Voltage	-1025		-870	mV	$0^\circ C$ to $+125^\circ C$	$V_{IN} = V_{IH(Max)}$ or $V_{IL(Min)}$	Loading with 50Ω to $-2.0V$	(Notes 7, 8, 9)
		-1085		-870	mV	$-55^\circ C$			
V_{OL}	Output LOW Voltage	-1830		-1620	mV	$0^\circ C$ to $+125^\circ C$	$V_{IN} = V_{IH(Min)}$ or $V_{IL(Max)}$	Loading with 50Ω to $-2.0V$	(Notes 7, 8, 9)
		-1830		-1555	mV	$-55^\circ C$			
V_{OHC}	Output HIGH Voltage	-1035			mV	$0^\circ C$ to $+125^\circ C$	$V_{IN} = V_{IH(Min)}$ or $V_{IL(Max)}$	Loading with 50Ω to $-2.0V$	(Notes 7, 8, 9)
		-1085			mV	$-55^\circ C$			
V_{OLC}	Output LOW Voltage			-1610	mV	$0^\circ C$ to $+125^\circ C$	$V_{IN} = V_{IH(Min)}$ or $V_{IL(Max)}$	Loading with 50Ω to $-2.0V$	(Notes 7, 8, 9)
				-1555	mV	$-55^\circ C$			

DC Electrical Characteristics

$V_{EE} = -4.2V$ to $-5.7V$, $V_{CC} = V_{CCA} = GND$ (Note 9)

Symbol	Parameter	Min	Typ	Max	Units	T_C	Conditions	Notes
V_{DIFF}	Input Voltage Differential	150			mV	$-55^\circ C$ to $+125^\circ C$	Required for Full Output Swing	(Notes 7, 8, 9)
V_{CM}	Common Mode Voltage	$V_{CC} - 2.0$		$V_{CC} - 0.5$	V	$-55^\circ C$ to $+125^\circ C$		(Notes 7, 8, 9)
V_{IH}	Single-Ended Input High Voltage	-1165		-870	mV	$-55^\circ C$ to $+125^\circ C$	Guaranteed HIGH Signal for All Inputs	(Notes 7, 8, 9, 10)
V_{IL}	Single-Ended Input Low Voltage	-1830		-1475	mV	$-55^\circ C$ to $+125^\circ C$	Guaranteed LOW Signal for All Inputs	(Notes 7, 8, 9, 10)

DC Electrical Characteristics (Continued)

$V_{EE} = -4.2V$ to $-5.7V$, $V_{CC} = V_{CCA} = GND$ (Note 9)

Symbol	Parameter	Min	Typ	Max	Units	T_C	Conditions	Notes
I_{IH}	Input HIGH Current CLKIN, \overline{CLKIN}			120	μA	$-55^\circ C$ to $+125^\circ C$	$V_{IN} = V_{IH(Max)}$	(Notes 7, 8, 9)
	TCLK			350	μA			
	CLKSEL			300	μA			
I_{CBO}	Input Leakage Current	-10			μA	$-55^\circ C$ to $+125^\circ C$	$V_{IN} = V_{EE}$	(Notes 7, 8, 9)
I_{EE}	Power Supply Current, Normal	-90		-30	mA	$-55^\circ C$ to $+125^\circ C$		(Notes 7, 8, 9)

Note 7: F100K 300 Series cold temperature testing is performed by temperature soaking (to guarantee junction temperature equals $-55^\circ C$), then testing immediately without allowing for the junction temperature to stabilize due to heat dissipation after power-up. This provides "cold start" specs which can be considered a worst case condition at cold temperatures.

Note 8: Screen tested 100% on each device at $-55^\circ C$, $+25^\circ C$, and $+125^\circ C$, Subgroups 1, 2, 3, 7, and 8.

Note 9: Sample tested (Method 5005, Table I) on each manufactured lot at $-55^\circ C$, $+25^\circ C$, and $+125^\circ C$, Subgroups A1, 2, 3, 7, and 8.

Note 10: Guaranteed by applying specified input condition and testing V_{OH}/V_{OL} .

AC Electrical Characteristics

$V_{EE} = -4.2V$ to $-5.7V$, $V_{CC} = V_{CCA} = GND$

Symbol	Parameter	$T_C = -55^\circ C$		$T_C = +25^\circ C$		$T_C = +125^\circ C$		Units	Conditions	Notes
		Min	Max	Min	Max	Min	Max			
t_{PLH}	Propagation Delay CLKIN, \overline{CLKIN} to $CLK_{(1-4)}$, $\overline{CLK}_{(1-4)}$	0.61	0.81	0.61	0.81	0.60	0.83	ns	Figures 1, 2	(Notes 11, 12, 13)
t_{PHL}										
t_{PLH} t_{PHL}	Propagation Delay, TCLK to $CLK_{(1-4)}$, $\overline{CLK}_{(1-4)}$	0.50	1.20	0.50	1.20	0.50	1.20	ns		
$t_{S\ G-G}$	Skew Gate to Gate (Note 15)		100		100		100	ps		(Note 13)
t_{TLH}	Transition Time	0.35	0.80	0.30	0.75	0.25	0.75	ns		
t_{THL}	20% to 80%, 80% to 20%									

Note 11: F100K 300 Series cold temperature testing is performed by temperature soaking (to guarantee junction temperature equals $-55^\circ C$), then testing immediately after power-up. This provides "cold start" specs which can be considered a worst case condition at cold temperatures.

Note 12: Screen tested 100% on each device at $+25^\circ C$ temperature only, Subgroup A9.

Note 13: Sample tested (Method 5005, Table I) on each manufactured lot at $+25^\circ C$, Subgroup A9, and at $+125^\circ C$ and $-55^\circ C$ temperatures, Subgroups A10 and A11.

Note 14: Not tested at $+25^\circ C$, $+125^\circ C$ and $-55^\circ C$ temperature (design characterization data).

Note 15: Maximum output skew for any one device.

AC Electrical Characteristics (Continued)

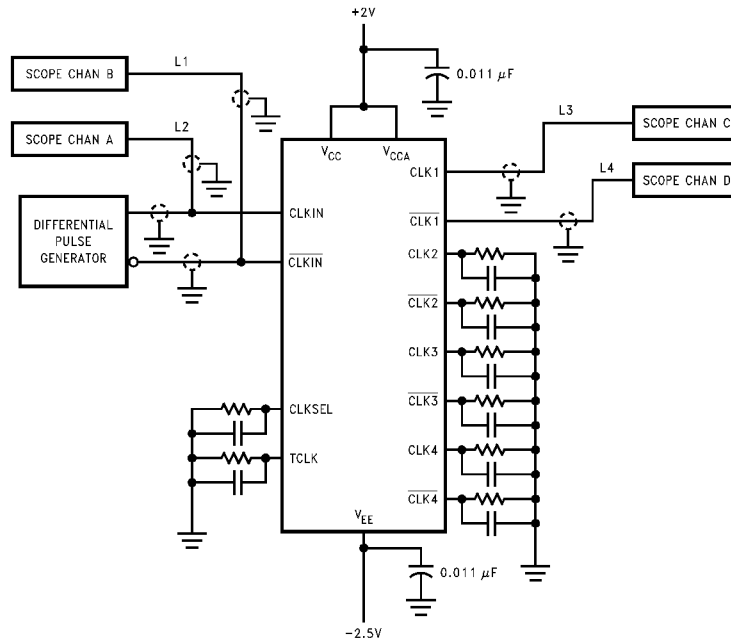

DS010960-3

Note 16: Shown for testing CLKIN to CLK1 in the differential mode.

Note 17: L1, L2, L3 and L4 = equal length 50Ω impedance lines.

Note 18: All unused inputs and outputs are loaded with 50Ω in parallel with ≤3 pF to GND.

Note 19: Scope should have 50Ω input terminator internally.

FIGURE 1. AC Test Circuit

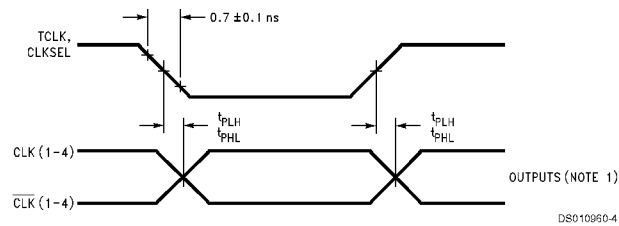

DS010960-4

FIGURE 2. Propagation Delay, TCLK, CLKSEL to Outputs

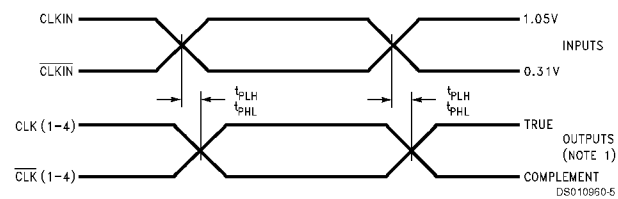

DS010960-5

FIGURE 3. Propagation Delay, CLKIN/CLKIN to Outputs

AC Electrical Characteristics (Continued)

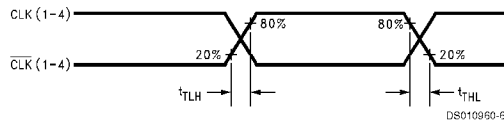

Note 20: The output to output skew, which is defined as the difference in the propagation delays between each of the four outputs on any one 100115 shall not exceed 75 ps.

FIGURE 4. Transition Times

Ordering Information

The device number is used to form part of a simplified purchasing code where the package type and temperature range are defined as follows:

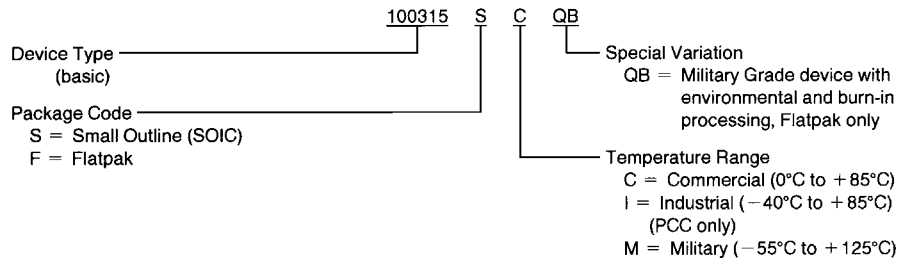

DS010950-7

Physical Dimensions inches (millimeters) unless otherwise noted

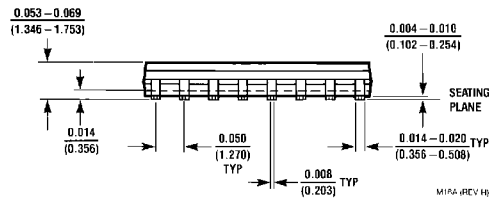
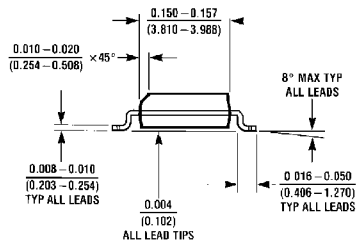
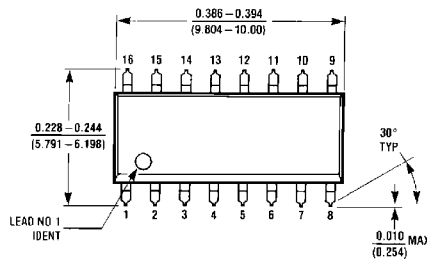

16 Lead Small Outline Integrated Circuit (S)
Package Number M16A

Physical Dimensions inches (millimeters) unless otherwise noted (Continued)

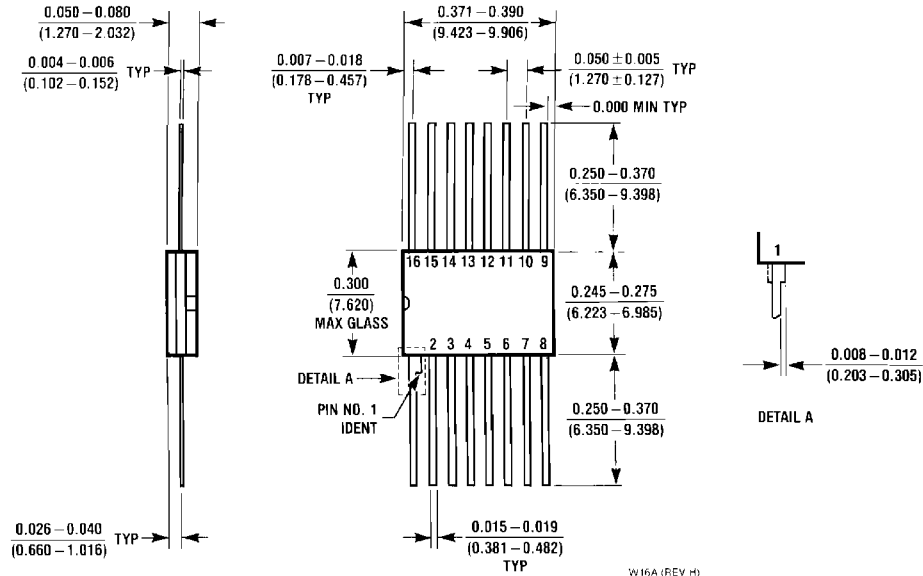

**16 Lead Ceramic Flatpak (F)
Package Number W16A**

W16A (REV H)

LIFE SUPPORT POLICY

FAIRCHILD'S PRODUCTS ARE NOT AUTHORIZED FOR USE AS CRITICAL COMPONENTS IN LIFE SUPPORT DEVICES OR SYSTEMS WITHOUT THE EXPRESS WRITTEN APPROVAL OF THE PRESIDENT OF FAIRCHILD SEMICONDUCTOR CORPORATION. As used herein:

1. Life support devices or systems are devices or systems which, (a) are intended for surgical implant into the body, or (b) support or sustain life, and (c) whose failure to perform when properly used in accordance with instructions for use provided in the labeling, can be reasonably expected to result in a significant injury to the user.
2. A critical component in any component of a life support device or system whose failure to perform can be reasonably expected to cause the failure of the life support device or system, or to affect its safety or effectiveness.

Fairchild Semiconductor Corporation Americas
Customer Response Center
Tel: 1-888-522-5372

Fairchild Semiconductor Europe
Fax: +49 (0) 1 80-530 85 86
Email: europe.support@nsc.com
Deutsch Tel: +49 (0) 8 141-35-0
English Tel: +44 (0) 1 793-85-68-56
Italy Tel: +39 (0) 2 57 5631

Fairchild Semiconductor Hong Kong Ltd.
13th Floor, Straight Block,
Ocean Centre, 5 Canton Rd.
Tsimshatsui, Kowloon
Hong Kong
Tel: +852 2737-7200
Fax: +852 2314-0061

National Semiconductor Japan Ltd.
Tel: 81-3-5620-6175
Fax: 81-3-5620-6179

www.fairchildsemi.com