

CBTV24DD12A

12-bit bus switch/multiplexer for DDR4-DDR3-DDR2 applications

Rev. 2 — 15 November 2017

Product data sheet

1. General description

CBTV24DD12A is designed for 1.8 V/2.5 V/3.3 V supply voltage operation and it supports Pseudo Open Drain (POD), SSTL_12, SSTL_15 or SSTL_18 signaling and CMOS select input levels. This device is designed for operation in DDR4, DDR3 or DDR2 memory bus systems, with speeds up to 3200 MT/s.

The CBTV24DD12A has a 1 : 2 switch or 2 : 1 multiplex topology and offers a 12-bit wide bus. Each 12-bit wide A-port can be switched to one of two ports B and C, for all bits simultaneously. Each port is non-directional due to the use of FET switches, allowing a multitude of applications requiring high-bandwidth switching or multiplexing.

The selection of the port is by a simple CMOS input (SELect). Another CMOS input (ENable) is available to allow all ports to be disconnected. The SEL0, SEL1 and EN input signals are designed to operate transparently as CMOS input level signals up to 3.3 V.

CBTV24DD12A uses NXP's proprietary high-speed switch architecture providing high bandwidth, very little insertion loss, return loss, and very low propagation delay, allowing use in many applications requiring switching or multiplexing of high-speed signals. It is available in a 3.0 mm × 8.0 mm TFBGA48 package with 0.65 mm ball pitch, for optimal size versus board layout density considerations. It is characterized for operation from -10 °C to +85 °C.

2. Features and benefits

2.1 Topology

- 12-bit bus width
- 1 : 2 switch/MUX topology
- Bidirectional operation
- Simple CMOS select pins (SEL0, SEL1)
- Simple CMOS enable pin (EN)

2.2 Performance

- 3200 MT/s throughput
- 7.4 GHz bandwidth (for both single-ended and differential signals)
- Low ON insertion loss
- Low return loss
- Low crosstalk
- High OFF isolation



- POD_12, SSTL_12, SSTL_15 or SSTL_18 signaling
- Low R_{ON} (8 Ω typical)
- Low ΔR_{ON} (<1 Ω)

2.3 General attributes

- 1.8 V/2.5 V/3.3 V supply voltage operation
- Very low supply current (600 μA typical)
- Back current protection on all the I/O pins of these switches
- ESD robustness exceeds 2.5 kV HBM, 1 kV CDM
- Available in TFBGA48 package, 3.0 mm × 8.0 mm × 1 mm size, 0.65 mm pitch, Pb-free/Dark Green

3. Applications

- DDR4/DDR3/DDR2 memory bus systems
- NVDIMM module
- Systems requiring high-speed multiplexing
- Flash memory array subsystem

4. Ordering information

Table 1. Ordering information

Type number	Topside mark	Package		
		Name	Description	Version
CBTV24DD12AET	2412A	TFBGA48	plastic low profile fine-pitch ball grid array package; 48 balls; body 3 × 8 × 1.05 mm; 0.65 mm pitch ^[1]	SOT1365-1

[1] Package built using SAC405 solder balls

4.1 Ordering options

Table 2. Ordering options

Type number	Orderable part number	Package	Packing method	Minimum order quantity	Temperature
CBTV24DD12AET	CBTV24DD12AETY	TFBGA48	Reel 13" Q1/T1 *Standard mark SMD dry pack	4500	T _{amb} = -10 °C to +85 °C

5. Functional diagram

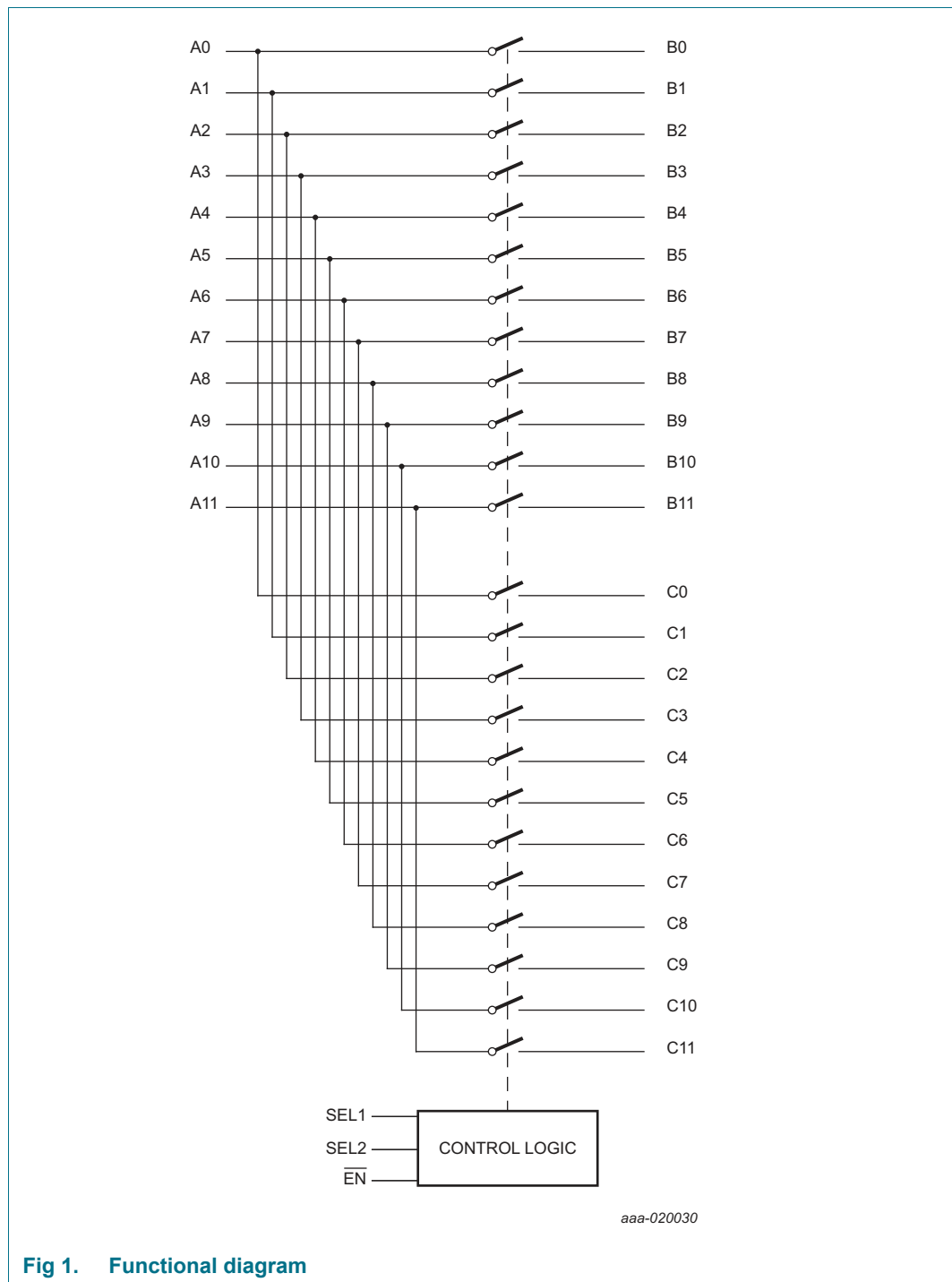

Fig 1. Functional diagram

6. Pinning information

6.1 Pinning

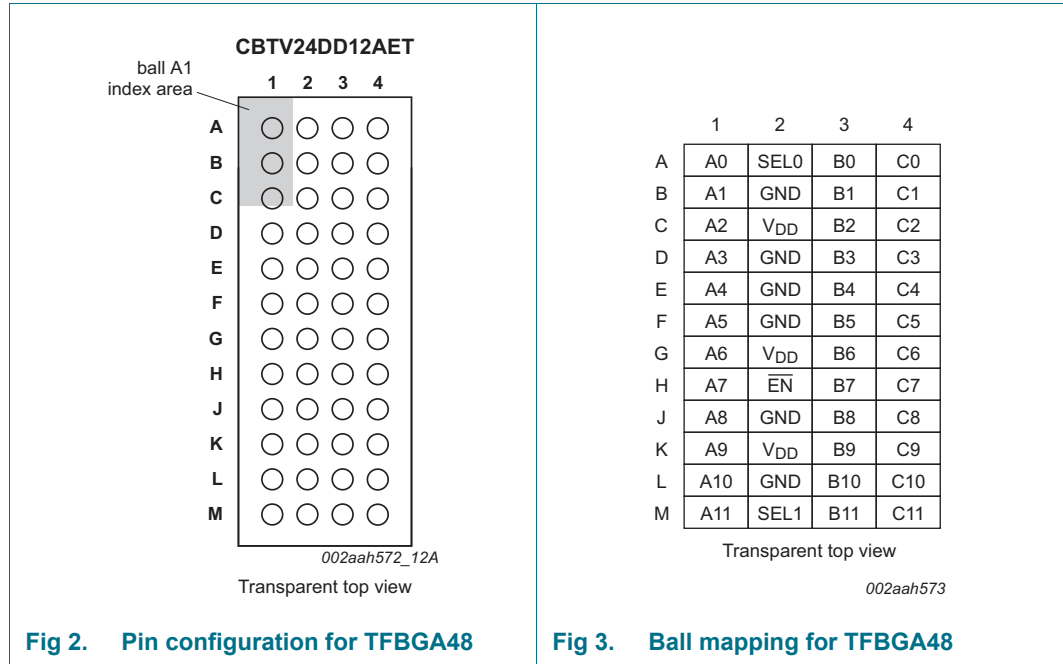

Fig 2. Pin configuration for TFBGA48

Fig 3. Ball mapping for TFBGA48

6.2 Pin description

Table 3. Pin description

Symbol	Pin	Type	Description
A[0:11]	A1, B1, C1, D1, E1, F1, G1, H1, J1, K1, L1, M1	high-speed I/O	12-bit wide input/output, port A
B[0:11]	A3, B3, C3, D3, E3, F3, G3, H3, J3, K3, L3, M3	high-speed I/O	12-bit wide input/output, port B
C[0:11]	A4, B4, C4, D4, E4, F4, G4, H4, J4, K4, L4, M4	high-speed I/O	12-bit wide input/output, port C
SEL0, SEL1	A2, M2	CMOS input	CMOS input signal. When SEL0 = LOW, port A[0,1,4,5,8,9] and port B[0,1,4,5,8,9] are mutually connected. When SEL0 = HIGH, port A[0,1,4,5,8,9] and port C[0,1,4,5,8,9] are mutually connected. When SEL1 = LOW, port A[2,3,6,7,10,11] and port B[2,3,6,7,10,11] are mutually connected. When SEL1 = HIGH, port A[2,3,6,7,10,11] and port C[2,3,6,7,10,11] are mutually connected.

Table 3. Pin description ...continued

Symbol	Pin	Type	Description
$\overline{\text{EN}}$	H2	CMOS input	CMOS input signal. When HIGH, all ports are mutually isolated. When LOW, connection is set using the SEL[0:1] input signals.
V _{DD}	C2, G2, K2	supply	Must be connected to supply voltage power plane.
GND	B2, D2, E2, F2, J2, L2	ground	Must be connected to GND plane for both electrical grounding and thermal relief.

7. Functional description

Refer to [Figure 1 “Functional diagram”](#).

CBTV24DD12A supports 1.8 V, 2.5 V or 3.3 V power supply voltages. All signal paths are implemented using high-bandwidth pass-gate technology and are non-directional. No clock or reset signal is needed for the multiplexer to function. The switch position for the channels is selected using the select signals (SEL0, SEL1). The detailed operation is described in [Section 7.1](#).

7.1 Function selection

The internal multiplexer switch position is controlled by three logic inputs, SEL0, SEL1 and EN, as described in [Table 4](#).

When a channel is not being used, Port B and Port C of this channel should be tied to ground. For example, if Channel 2 is not used, B2 and C2 should be tied to ground and A2 should be left open.

Table 4. Function selection

X = don't care.

Inputs		Switch position	
EN	SELx	A ↔ B	A ↔ C
HIGH	X	OFF (isolated)	OFF (isolated)
LOW	SEL0 = LOW	A[0,1,4,5,8,9] ↔ B[0,1,4,5,8,9]	OFF (isolated)
LOW	SEL0 = HIGH	OFF (isolated)	A[0,1,4,5,8,9] ↔ C[0,1,4,5,8,9]
LOW	SEL1 = LOW	A[2,3,6,7,10,11] ↔ B[2,3,6,7,10,11]	OFF (isolated)
LOW	SEL1 = HIGH	OFF (isolated)	A[2,3,6,7,10,11] ↔ C[2,3,6,7,10,11]

8. Limiting values

Table 5. Limiting values

In accordance with the Absolute Maximum Rating System (IEC 60134).

Symbol	Parameter	Conditions	Min	Max	Unit
V _{DD}	supply voltage		-0.3	+4.4	V
T _{stg}	storage temperature		-65	+150	°C
V _{ESD}	electrostatic discharge voltage	HBM [1]	-	2500	V
		CDM [2]	-	1000	V

[1] Human Body Model: ANSI/ESDA/JEDEC JDS-001-2012 (Revision of ANSI/ESDA/JEDEC JS-001-2011), ESDA/JEDEC Joint standard for ESD sensitivity testing. Human Body Model - Component level; Electrostatic Discharge Association, Rome, NY, USA.; JEDEC Solid State Technology Association, Arlington, VA, USA.

[2] Charged-Device Model: JESD22-C101E December 2009 (Revision of JESD22-C101D, October 2008), standard for ESD sensitivity testing, Charged-Device Model - Component level; JEDEC Solid State Technology Association, Arlington, VA, USA.

9. Recommended operating conditions

Table 6. Operating conditions

Symbol	Parameter	Conditions	Min	Typ	Max	Unit
V _{DD}	supply voltage		1.62	-	3.63	V
V _I	input voltage	channel inputs/outputs	-0.3	-	+1.8	V
		control inputs	-0.3	-	+3.6	V
T _{amb}	ambient temperature	operating in free air	-10	-	+85	°C

10. Static characteristics

Table 7. Static characteristics

Typical V_{DD}; T_{amb} = -10 °C to +85 °C; unless otherwise specified.

Symbol	Parameter	Conditions	Min	Typ ^[1]	Max	Unit
I _{DD}	supply current	\overline{EN} = LOW	-	0.6	1.3	mA
		\overline{EN} = HIGH	-	-	45	μA
I _{IH}	HIGH-level input current	High-speed I/O; A, B and C ports; V _I = 1.8 V	-	-	±5	μA
		Control pins; SEL0, SEL1 and EN; V _I = 3.6 V	-	-	±10	μA
I _{IL}	LOW-level input current	V _I = GND	-	-	±5	μA
V _{IH}	HIGH-level input voltage	SEL0, SEL1, \overline{EN} pins	1.4	-	-	V
V _{IL}	LOW-level input voltage	SEL0, SEL1, \overline{EN} pins	-0.5	-	+0.4	V
V _{IK}	input clamping voltage	voltage on high-speed channel pins; I _I = -18 mA	-	-	-1.2	V

[1] Typical values are at V_{DD} = 2.5 V; T_{amb} = 25 °C, and maximum loading.

11. Dynamic characteristics

Table 8. Dynamic characteristics

Symbol	Parameter	Conditions	Min	Typ	Max	Unit
t_{startup}	start-up time	supply voltage valid or EN going HIGH to channel specified operating characteristics	-	90	300	μs
t_{rcfg}	reconfiguration time	SEL[0:1] state change to channel specified operating characteristics; measuring from 50 % of SELx to 90 % of channel output	[1] -	-	30	ns
α_{il}	insertion loss	channel is on; $0 \text{ Hz} \leq f \leq 4 \text{ GHz}$	-	-1.5	-	dB
		channel is on; $f = 7 \text{ GHz}$	-	-3.0	-	dB
		channel is off; $0 \text{ Hz} \leq f \leq 4 \text{ GHz}$	-	-20	-	dB
RL_{in}	input return loss	channel is on; $0 \text{ Hz} \leq f \leq 4 \text{ GHz}$	-	-16	-	dB
α_{ct}	crosstalk attenuation	adjacent channels are on; $0 \text{ Hz} \leq f \leq 4 \text{ GHz}$	-	-24	-	dB
B	bandwidth	-3.0 dB intercept (for both single-ended and differential signals)	-	7.4	-	GHz
t_{PD}	propagation delay	from A port to B port or C port or vice versa	-	65	-	ps
t_{sk}	skew time	from any output to any output	-	3	6	ps
R_{ON}	ON resistance	from any input to any output	5	6.5	9	Ω
$R_{\text{ON(Flat)}}$	ON resistance (flatness)		[2] -	1.5	-	Ω
ΔR_{ON}	ON resistance mismatch between channels		[3][4] -	0.4	1	Ω

[1] Smooth transition without glitch under DDR termination schemes.

[2] $R_{\text{ON(Flat)}}$ is the difference of the R_{ON} in a given channel across all V_{I} voltage ranges.

[3] ΔR_{ON} is the difference of R_{ON} from one port to any other ports when the same V_{I} voltage is applied to all channels.

[4] Guaranteed by design.

12. Package outline

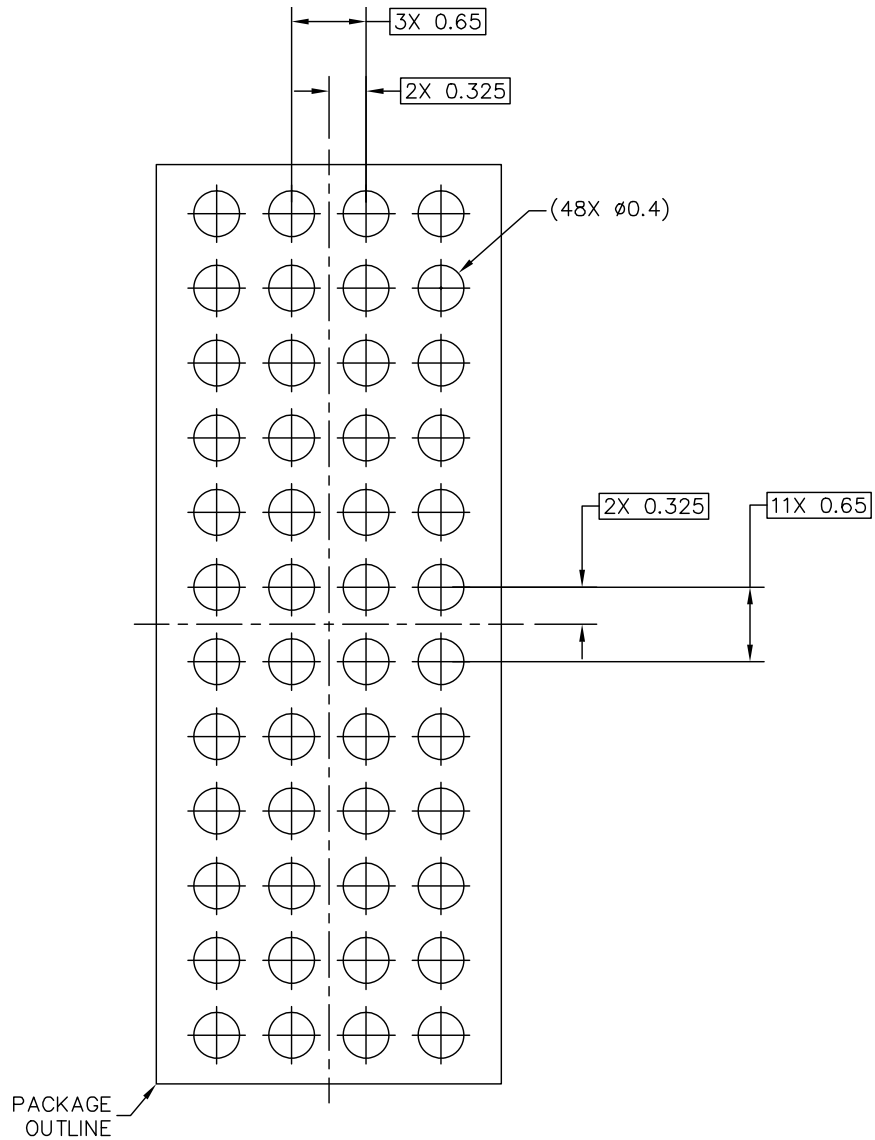

PCB DESIGN GUIDELINES – SOLDER MASK OPENING PATTERN

THIS SHEET SERVES ONLY AS A GUIDELINE TO HELP DEVELOP A USER SPECIFIC SOLUTION. DEVELOPMENT EFFORT WILL STILL BE REQUIRED BY END USERS TO OPTIMIZE PCB MOUNTING PROCESSES AND BOARD DESIGN IN ORDER TO MEET INDIVIDUAL/SPECIFIC REQUIREMENTS.

© NXP SEMICONDUCTORS N.V. ALL RIGHTS RESERVED DATE: 23 OCT 2017

MECHANICAL OUTLINE PRINT VERSION NOT TO SCALE	STANDARD: NON JEDEC	DRAWING NUMBER: SOT1365-1	REVISION: 0	
--	------------------------	------------------------------	----------------	--

Fig 4. Package outline TFBGA48 (SOT1365-1) (1 of 3)

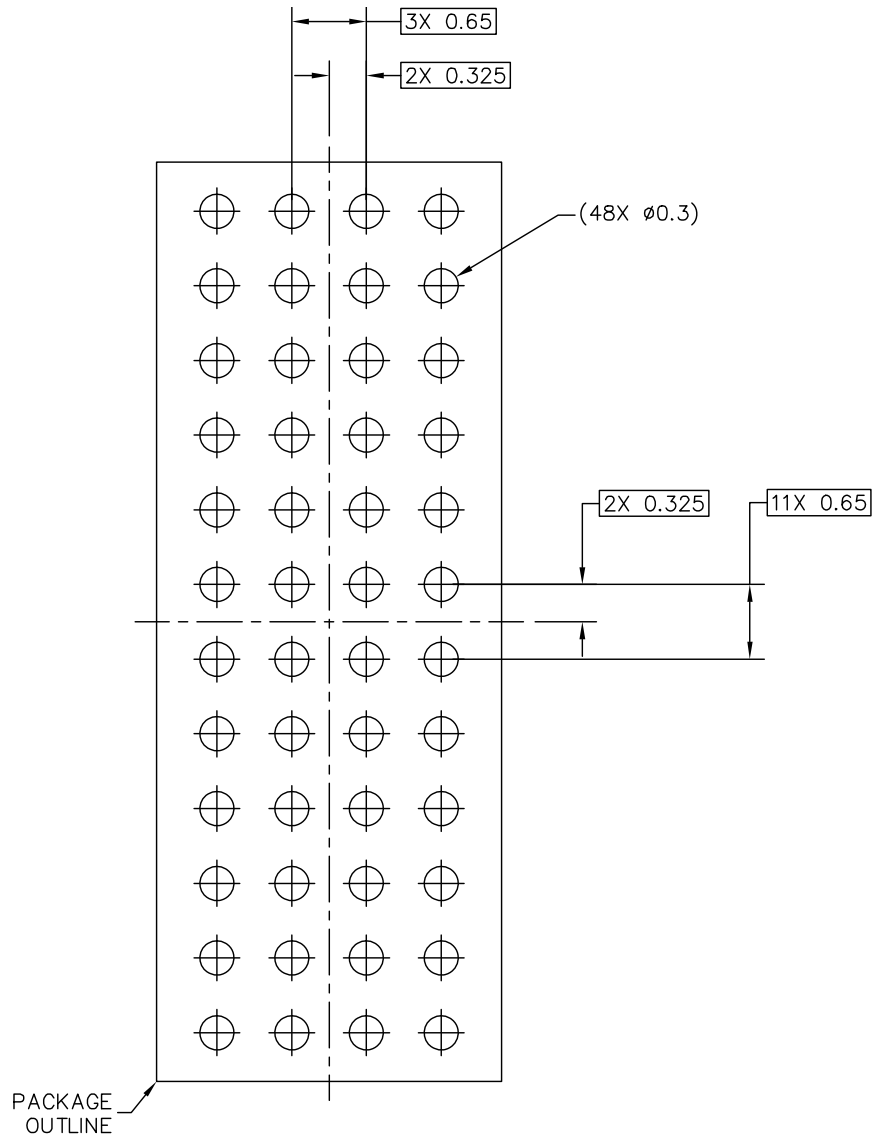

PCB DESIGN GUIDELINES – I/O PADS AND SOLDERABLE AREA

THIS SHEET SERVES ONLY AS A GUIDELINE TO HELP DEVELOP A USER SPECIFIC SOLUTION. DEVELOPMENT EFFORT WILL STILL BE REQUIRED BY END USERS TO OPTIMIZE PCB MOUNTING PROCESSES AND BOARD DESIGN IN ORDER TO MEET INDIVIDUAL/SPECIFIC REQUIREMENTS.

© NXP SEMICONDUCTORS N.V. ALL RIGHTS RESERVED DATE: 23 OCT 2017

MECHANICAL OUTLINE PRINT VERSION NOT TO SCALE	STANDARD: NON JEDEC	DRAWING NUMBER: SOT1365-1	REVISION: 0	
--	------------------------	------------------------------	----------------	--

Fig 5. Package outline TFPGA48 (SOT1365-1) (2 of 3)

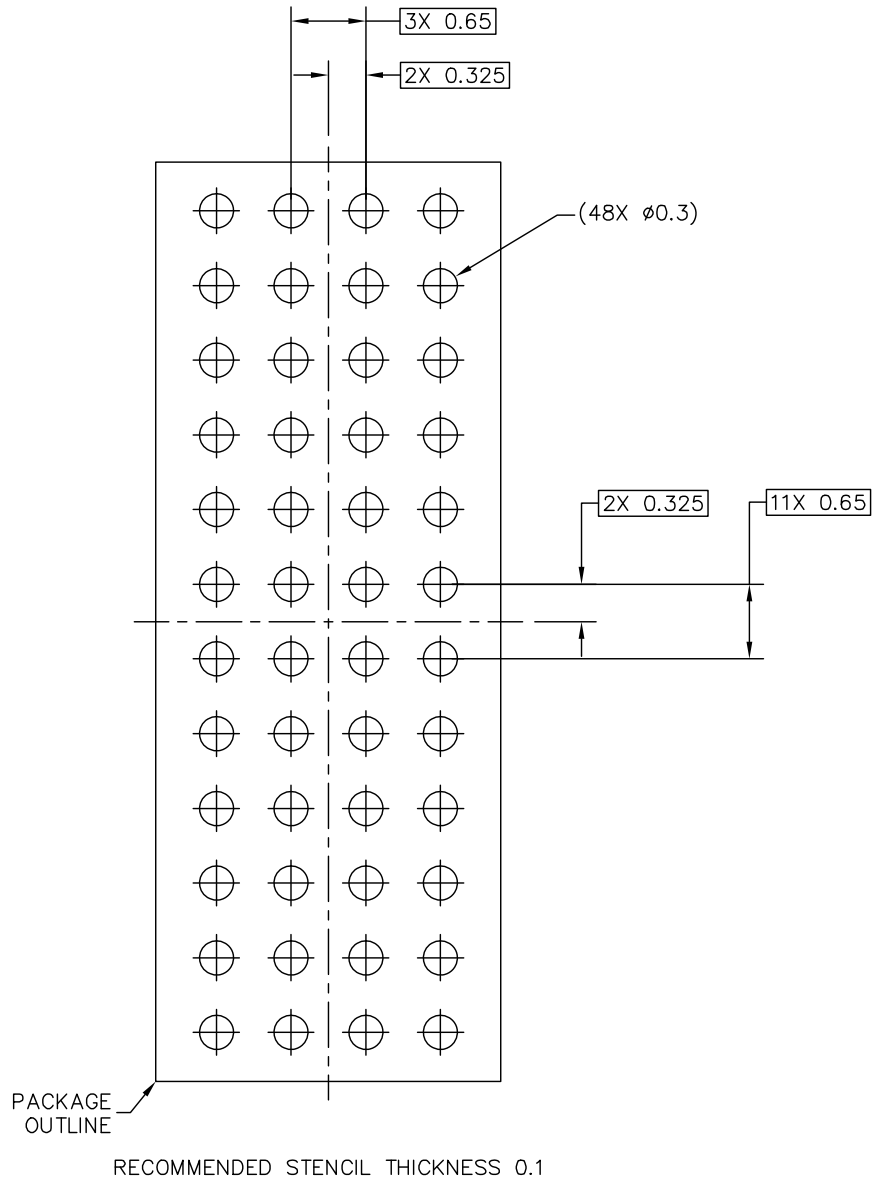

PCB DESIGN GUIDELINES – SOLDER PASTE STENCIL

THIS SHEET SERVES ONLY AS A GUIDELINE TO HELP DEVELOP A USER SPECIFIC SOLUTION. DEVELOPMENT EFFORT WILL STILL BE REQUIRED BY END USERS TO OPTIMIZE PCB MOUNTING PROCESSES AND BOARD DESIGN IN ORDER TO MEET INDIVIDUAL/SPECIFIC REQUIREMENTS.

© NXP SEMICONDUCTORS N.V. ALL RIGHTS RESERVED

DATE: 23 OCT 2017

MECHANICAL OUTLINE PRINT VERSION NOT TO SCALE	STANDARD: NON JEDEC	DRAWING NUMBER: SOT1365-1	REVISION: 0	
--	------------------------	------------------------------	----------------	--

Fig 6. Package outline TFPGA48 (SOT1365-1) (3 of 3)

13. Packing information

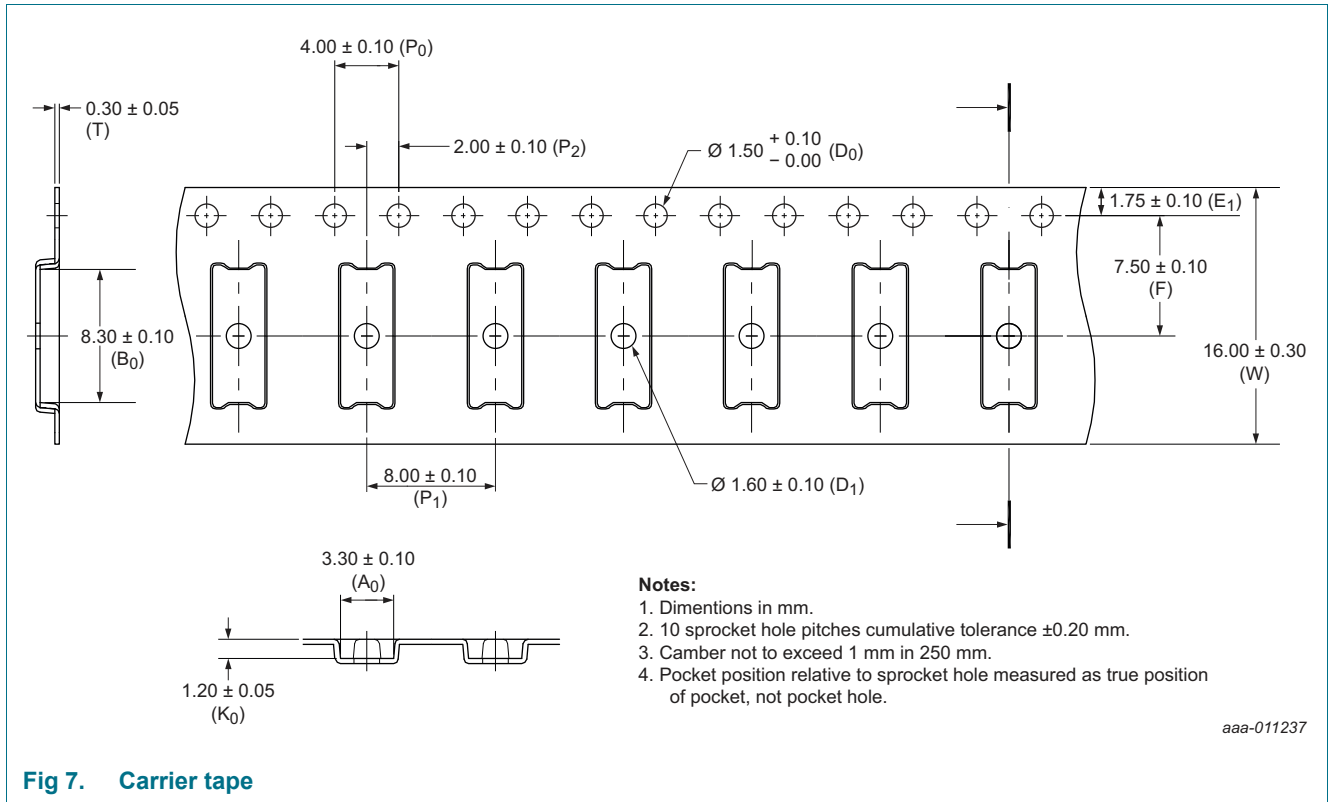
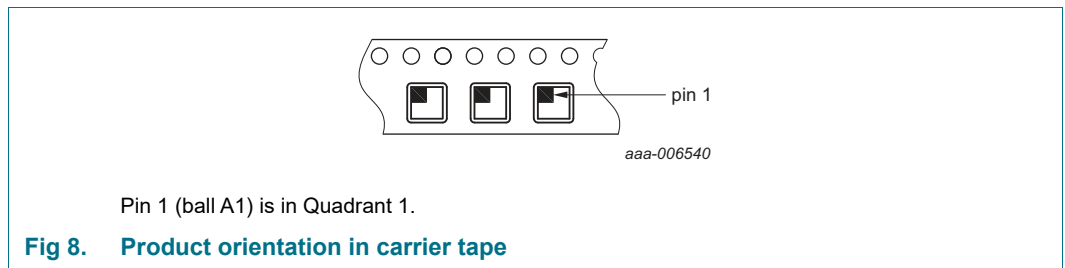

Fig 7. Carrier tape



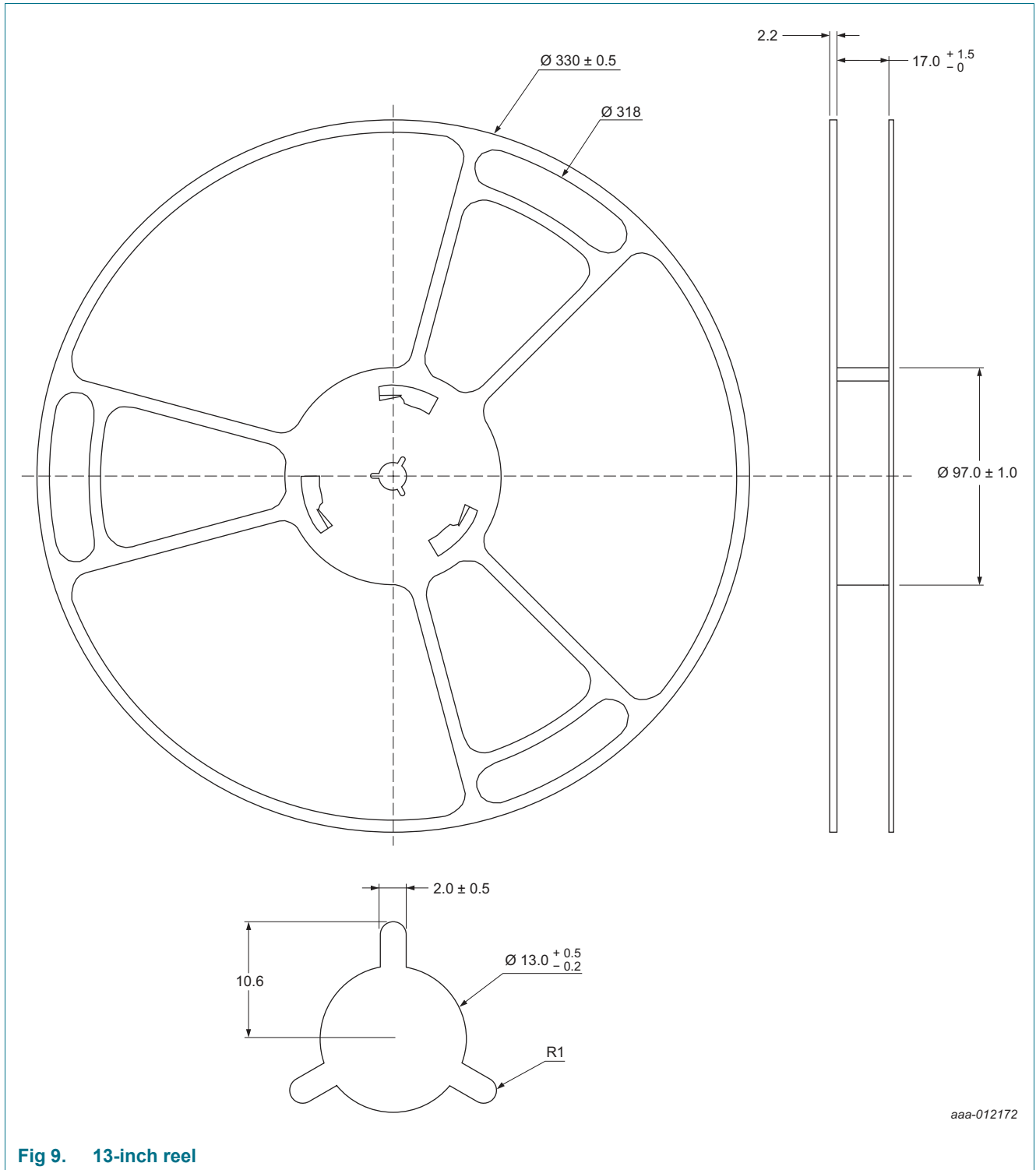

Fig 9. 13-inch reel

14. Soldering of SMD packages

This text provides a very brief insight into a complex technology. A more in-depth account of soldering ICs can be found in Application Note *AN10365 "Surface mount reflow soldering description"*.

14.1 Introduction to soldering

Soldering is one of the most common methods through which packages are attached to Printed Circuit Boards (PCBs), to form electrical circuits. The soldered joint provides both the mechanical and the electrical connection. There is no single soldering method that is ideal for all IC packages. Wave soldering is often preferred when through-hole and Surface Mount Devices (SMDs) are mixed on one printed wiring board; however, it is not suitable for fine pitch SMDs. Reflow soldering is ideal for the small pitches and high densities that come with increased miniaturization.

14.2 Wave and reflow soldering

Wave soldering is a joining technology in which the joints are made by solder coming from a standing wave of liquid solder. The wave soldering process is suitable for the following:

- Through-hole components
- Leaded or leadless SMDs, which are glued to the surface of the printed circuit board

Not all SMDs can be wave soldered. Packages with solder balls, and some leadless packages which have solder lands underneath the body, cannot be wave soldered. Also, leaded SMDs with leads having a pitch smaller than ~0.6 mm cannot be wave soldered, due to an increased probability of bridging.

The reflow soldering process involves applying solder paste to a board, followed by component placement and exposure to a temperature profile. Leaded packages, packages with solder balls, and leadless packages are all reflow solderable.

Key characteristics in both wave and reflow soldering are:

- Board specifications, including the board finish, solder masks and vias
- Package footprints, including solder thieves and orientation
- The moisture sensitivity level of the packages
- Package placement
- Inspection and repair
- Lead-free soldering versus SnPb soldering

14.3 Wave soldering

Key characteristics in wave soldering are:

- Process issues, such as application of adhesive and flux, clinching of leads, board transport, the solder wave parameters, and the time during which components are exposed to the wave
- Solder bath specifications, including temperature and impurities

14.4 Reflow soldering

Key characteristics in reflow soldering are:

- Lead-free versus SnPb soldering; note that a lead-free reflow process usually leads to higher minimum peak temperatures (see [Figure 10](#)) than a SnPb process, thus reducing the process window
- Solder paste printing issues including smearing, release, and adjusting the process window for a mix of large and small components on one board
- Reflow temperature profile; this profile includes preheat, reflow (in which the board is heated to the peak temperature) and cooling down. It is imperative that the peak temperature is high enough for the solder to make reliable solder joints (a solder paste characteristic). In addition, the peak temperature must be low enough that the packages and/or boards are not damaged. The peak temperature of the package depends on package thickness and volume and is classified in accordance with [Table 9](#) and [10](#)

Table 9. SnPb eutectic process (from J-STD-020D)

Package thickness (mm)	Package reflow temperature (°C)	
	Volume (mm ³)	
	< 350	≥ 350
< 2.5	235	220
≥ 2.5	220	220

Table 10. Lead-free process (from J-STD-020D)

Package thickness (mm)	Package reflow temperature (°C)		
	Volume (mm ³)		
	< 350	350 to 2000	> 2000
< 1.6	260	260	260
1.6 to 2.5	260	250	245
> 2.5	250	245	245

Moisture sensitivity precautions, as indicated on the packing, must be respected at all times.

Studies have shown that small packages reach higher temperatures during reflow soldering, see [Figure 10](#).

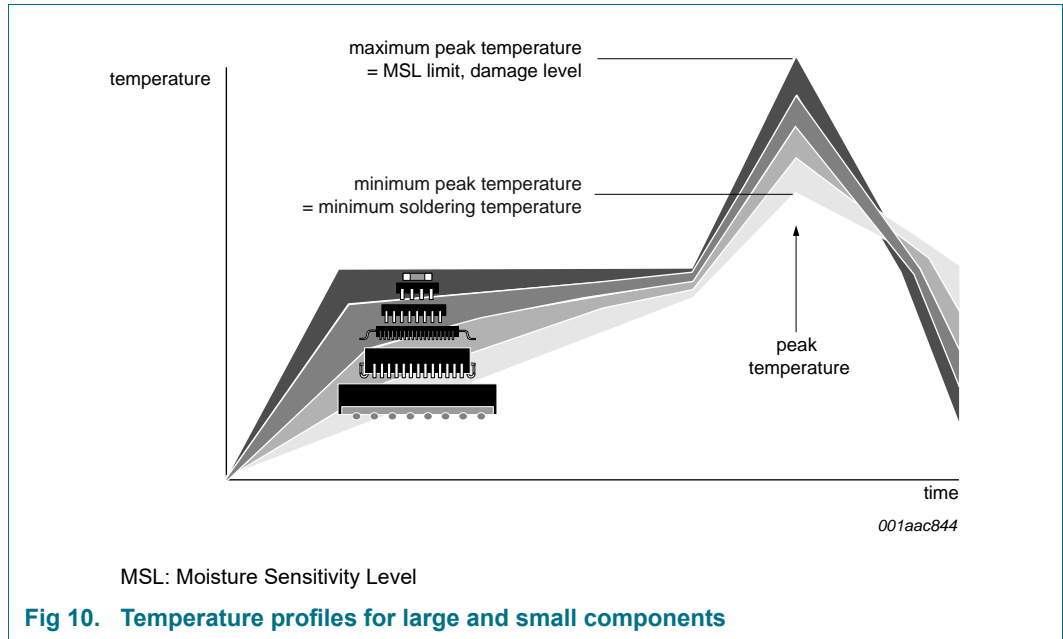

For further information on temperature profiles, refer to Application Note AN10365 “Surface mount reflow soldering description”.

15. Soldering: PCB footprints

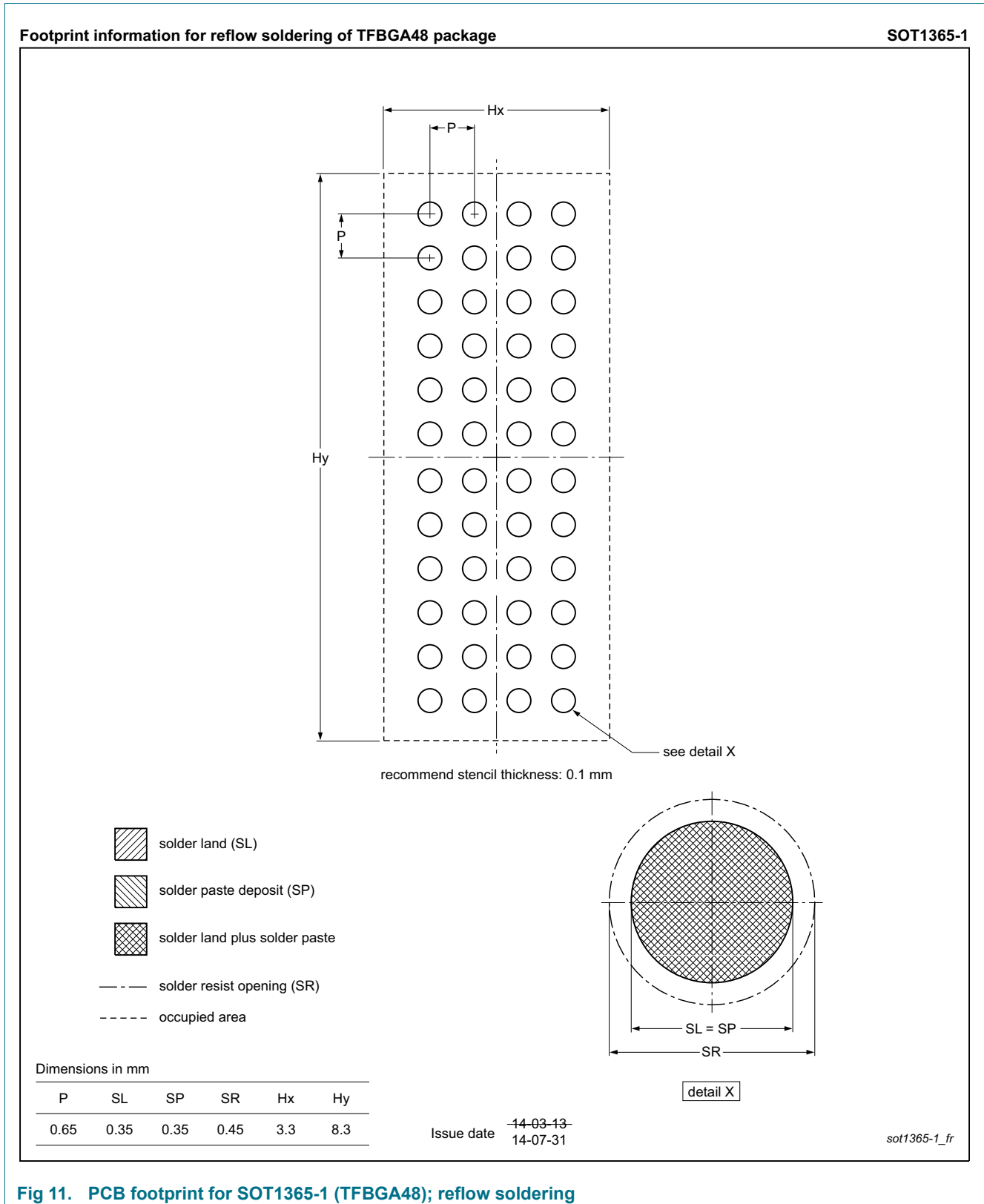

Fig 11. PCB footprint for SOT1365-1 (TFBGA48); reflow soldering

16. Abbreviations

Table 11. Abbreviations

Acronym	Description
CDM	Charged-Device Model
CMOS	Complementary Metal-Oxide Semiconductor
DDR2	Double Data Rate 2
DDR3	Double Data Rate 3
DDR4	Double Data Rate 4
DRAM	Dynamic Random Access Memory
ESD	ElectroStatic Discharge
FET	Field-Effect Transistor
HBM	Human Body Model
I/O	Input/Output
MT/s	Mega Transfers per second
NVDIMM	Non-Volatile Dual In-line Memory Module
POD	Pseudo Open Drain
SSTL_12	Stub Series Terminated Logic for 1.2 V
SSTL_15	Stub Series Terminated Logic for 1.5 V
SSTL_18	Stub Series Terminated Logic for 1.8 V

17. Revision history

Table 12. Revision history

Document ID	Release date	Data sheet status	Change notice	Supersedes
CBTV24DD12A v.2	20171115	Product data sheet	-	CBTV24DD12A v.1
Modifications:	<ul style="list-style-type: none"> Updated Figure 4 "Package outline TFBGA48 (SOT1365-1) (1 of 3)" 			
CBTV24DD12A v.1	20170628	Product data sheet	-	-

18. Legal information

18.1 Data sheet status

Document status ^{[1][2]}	Product status ^[3]	Definition
Objective [short] data sheet	Development	This document contains data from the objective specification for product development.
Preliminary [short] data sheet	Qualification	This document contains data from the preliminary specification.
Product [short] data sheet	Production	This document contains the product specification.

[1] Please consult the most recently issued document before initiating or completing a design.

[2] The term 'short data sheet' is explained in section "Definitions".

[3] The product status of device(s) described in this document may have changed since this document was published and may differ in case of multiple devices. The latest product status information is available on the Internet at URL <http://www.nxp.com>.

18.2 Definitions

Draft — The document is a draft version only. The content is still under internal review and subject to formal approval, which may result in modifications or additions. NXP Semiconductors does not give any representations or warranties as to the accuracy or completeness of information included herein and shall have no liability for the consequences of use of such information.

Short data sheet — A short data sheet is an extract from a full data sheet with the same product type number(s) and title. A short data sheet is intended for quick reference only and should not be relied upon to contain detailed and full information. For detailed and full information see the relevant full data sheet, which is available on request via the local NXP Semiconductors sales office. In case of any inconsistency or conflict with the short data sheet, the full data sheet shall prevail.

Product specification — The information and data provided in a Product data sheet shall define the specification of the product as agreed between NXP Semiconductors and its customer, unless NXP Semiconductors and customer have explicitly agreed otherwise in writing. In no event however, shall an agreement be valid in which the NXP Semiconductors product is deemed to offer functions and qualities beyond those described in the Product data sheet.

18.3 Disclaimers

Limited warranty and liability — Information in this document is believed to be accurate and reliable. However, NXP Semiconductors does not give any representations or warranties, expressed or implied, as to the accuracy or completeness of such information and shall have no liability for the consequences of use of such information. NXP Semiconductors takes no responsibility for the content in this document if provided by an information source outside of NXP Semiconductors.

In no event shall NXP Semiconductors be liable for any indirect, incidental, punitive, special or consequential damages (including - without limitation - lost profits, lost savings, business interruption, costs related to the removal or replacement of any products or rework charges) whether or not such damages are based on tort (including negligence), warranty, breach of contract or any other legal theory.

Notwithstanding any damages that customer might incur for any reason whatsoever, NXP Semiconductors' aggregate and cumulative liability towards customer for the products described herein shall be limited in accordance with the *Terms and conditions of commercial sale* of NXP Semiconductors.

Right to make changes — NXP Semiconductors reserves the right to make changes to information published in this document, including without limitation specifications and product descriptions, at any time and without notice. This document supersedes and replaces all information supplied prior to the publication hereof.

Suitability for use — NXP Semiconductors products are not designed, authorized or warranted to be suitable for use in life support, life-critical or safety-critical systems or equipment, nor in applications where failure or malfunction of an NXP Semiconductors product can reasonably be expected to result in personal injury, death or severe property or environmental damage. NXP Semiconductors and its suppliers accept no liability for inclusion and/or use of NXP Semiconductors products in such equipment or applications and therefore such inclusion and/or use is at the customer's own risk.

Applications — Applications that are described herein for any of these products are for illustrative purposes only. NXP Semiconductors makes no representation or warranty that such applications will be suitable for the specified use without further testing or modification.

Customers are responsible for the design and operation of their applications and products using NXP Semiconductors products, and NXP Semiconductors accepts no liability for any assistance with applications or customer product design. It is customer's sole responsibility to determine whether the NXP Semiconductors product is suitable and fit for the customer's applications and products planned, as well as for the planned application and use of customer's third party customer(s). Customers should provide appropriate design and operating safeguards to minimize the risks associated with their applications and products.

NXP Semiconductors does not accept any liability related to any default, damage, costs or problem which is based on any weakness or default in the customer's applications or products, or the application or use by customer's third party customer(s). Customer is responsible for doing all necessary testing for the customer's applications and products using NXP Semiconductors products in order to avoid a default of the applications and the products or of the application or use by customer's third party customer(s). NXP does not accept any liability in this respect.

Limiting values — Stress above one or more limiting values (as defined in the Absolute Maximum Ratings System of IEC 60134) will cause permanent damage to the device. Limiting values are stress ratings only and (proper) operation of the device at these or any other conditions above those given in the Recommended operating conditions section (if present) or the Characteristics sections of this document is not warranted. Constant or repeated exposure to limiting values will permanently and irreversibly affect the quality and reliability of the device.

Terms and conditions of commercial sale — NXP Semiconductors products are sold subject to the general terms and conditions of commercial sale, as published at <http://www.nxp.com/profile/terms>, unless otherwise agreed in a valid written individual agreement. In case an individual agreement is concluded only the terms and conditions of the respective agreement shall apply. NXP Semiconductors hereby expressly objects to applying the customer's general terms and conditions with regard to the purchase of NXP Semiconductors products by customer.

No offer to sell or license — Nothing in this document may be interpreted or construed as an offer to sell products that is open for acceptance or the grant, conveyance or implication of any license under any copyrights, patents or other industrial or intellectual property rights.

Export control — This document as well as the item(s) described herein may be subject to export control regulations. Export might require a prior authorization from competent authorities.

Non-automotive qualified products — Unless this data sheet expressly states that this specific NXP Semiconductors product is automotive qualified, the product is not suitable for automotive use. It is neither qualified nor tested in accordance with automotive testing or application requirements. NXP Semiconductors accepts no liability for inclusion and/or use of non-automotive qualified products in automotive equipment or applications.

In the event that customer uses the product for design-in and use in automotive applications to automotive specifications and standards, customer (a) shall use the product without NXP Semiconductors' warranty of the product for such automotive applications, use and specifications, and (b) whenever customer uses the product for automotive applications beyond

NXP Semiconductors' specifications such use shall be solely at customer's own risk, and (c) customer fully indemnifies NXP Semiconductors for any liability, damages or failed product claims resulting from customer design and use of the product for automotive applications beyond NXP Semiconductors' standard warranty and NXP Semiconductors' product specifications.

Translations — A non-English (translated) version of a document is for reference only. The English version shall prevail in case of any discrepancy between the translated and English versions.

18.4 Trademarks

Notice: All referenced brands, product names, service names and trademarks are the property of their respective owners.

19. Contact information

For more information, please visit: <http://www.nxp.com>

For sales office addresses, please send an email to: salesaddresses@nxp.com

20. Contents

1	General description	1
2	Features and benefits	1
2.1	Topology	1
2.2	Performance	1
2.3	General attributes	2
3	Applications	2
4	Ordering information	2
4.1	Ordering options	2
5	Functional diagram	3
6	Pinning information	4
6.1	Pinning	4
6.2	Pin description	4
7	Functional description	6
7.1	Function selection	6
8	Limiting values	7
9	Recommended operating conditions	7
10	Static characteristics	7
11	Dynamic characteristics	8
12	Package outline	9
13	Packing information	12
14	Soldering of SMD packages	14
14.1	Introduction to soldering	14
14.2	Wave and reflow soldering	14
14.3	Wave soldering	14
14.4	Reflow soldering	15
15	Soldering: PCB footprints	17
16	Abbreviations	18
17	Revision history	18
18	Legal information	19
18.1	Data sheet status	19
18.2	Definitions	19
18.3	Disclaimers	19
18.4	Trademarks	20
19	Contact information	20
20	Contents	21

Please be aware that important notices concerning this document and the product(s) described herein, have been included in section 'Legal information'.

© NXP B.V. 2019.

All rights reserved.

For more information, please visit: <http://www.nxp.com>

For sales office addresses, please send an email to: salesaddresses@nxp.com

Date of release: 15 November 2017

Document identifier: CBT24DD12A