

PART No. EPGDH2024

for more information visit
www.hammfg.com

Data subject to change without notice

Isometric drawing Not to Scale



SIDE VIEW

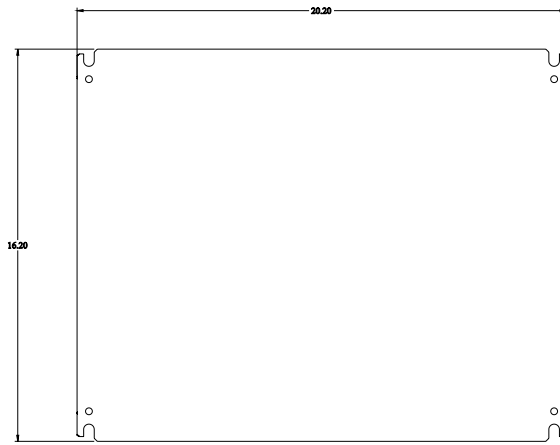

FRONT VIEW

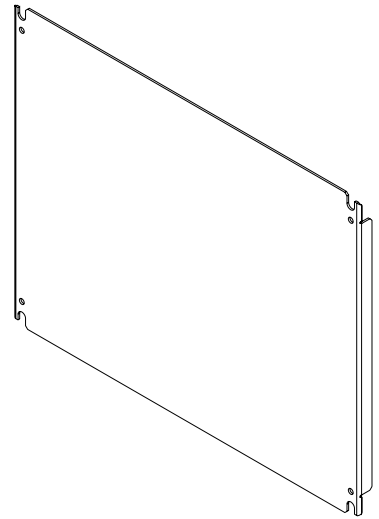

ISOMETRIC VIEW