

PART NUMBER	DESCRIPTION
M-0650CC0650-0140ZC	COVER
M-0650SB0650-0140ZF	FRAME

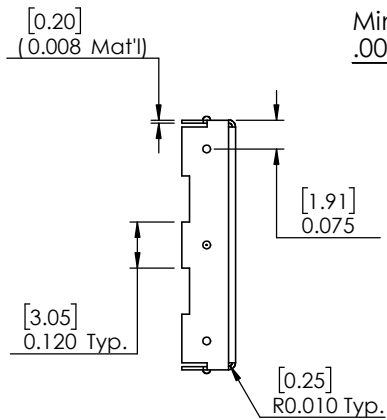

Mini. Contact Dimples  
.005" Tall on .5" Pitch

Mini. Locking Dimples  
.010" Tall on .5" Pitch

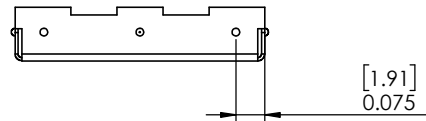
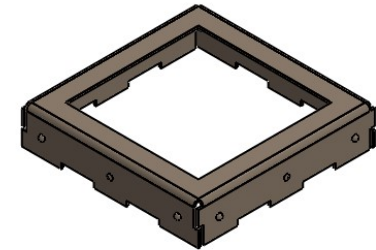
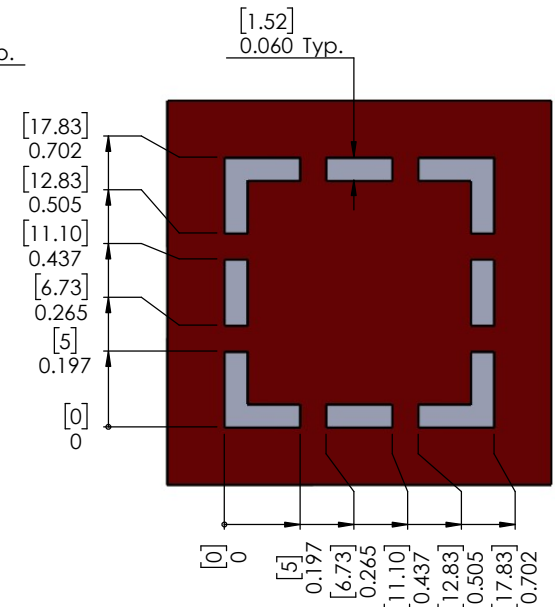
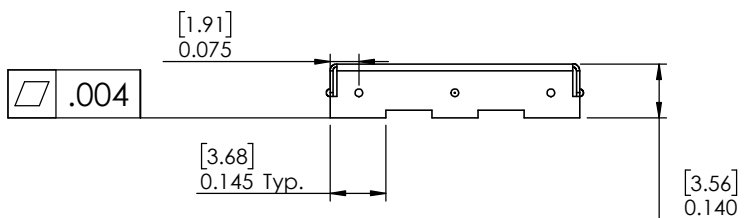
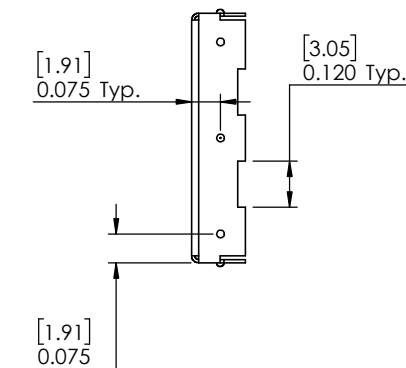
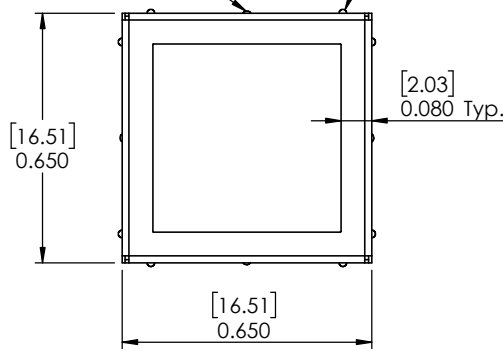

RoHS Compliant

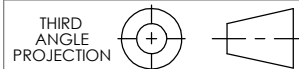

DO NOT SCALE DRAWING

**PROPRIETARY AND CONFIDENTIAL**

THE INFORMATION CONTAINED IN THIS DRAWING IS THE SOLE PROPERTY OF ORBEL CORPORATION. ANY REPRODUCTION IN PART OR AS A WHOLE WITHOUT THE WRITTEN PERMISSION OF ORBEL CORPORATION IS PROHIBITED.

DIMENSIONS ARE IN INCHES [MILLIMETERS]

TOLERANCES:

FRACTIONAL ±

ANGULAR: MACH ± 3 Degrees

TWO PLACE DECIMAL ± .015 [.381]

THREE PLACE DECIMAL ± .010 [.254]

MATERIAL:

.008" [.203] NICKEL SILVER, 1/2 HARD

FINISH:

WEIGHT: 0.019oz. [0.549g]

	NAME	DATE
DRAWN	TNC	1/18/2012
CHECKED		
ENG APPR.		
MFG APPR.		
Q.A.		

COMMENTS:

**ORBEL**  
ENGINEERED SOLUTIONS

SIZE	DWG NO.	REV.
A	M-0650SB0650-0140ZF	01
SCALE: 2:1	CAGE CODE: 57DU2	SHEET 1 OF 2

# HOW TO ORDER BOARD LEVEL SHIELDING

The chart below is an easy-to-use reference on how Orbel BLS part numbers are created and used to order standard and custom board level shielding. Custom configurations that fall outside of our standard shield styles are also available.

## Sample Part Number (Snap-Shield Bullzeye™): B-0750TB1125-0250XF - TPS



# STANDARD FEATURES

## PIN OPTIONS

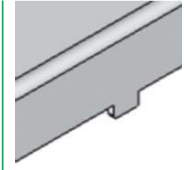

Alignment Pin

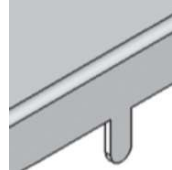

Through-Hole Pin

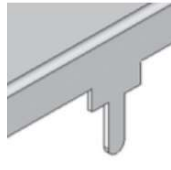

Through-Hole Pin with Standoff

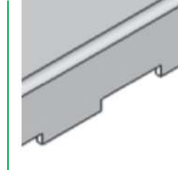

Castellation Edge

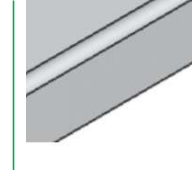

Straight Edge, No Pin

## CORNER OPTIONS

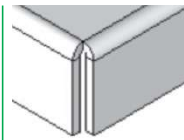

Tight Corner

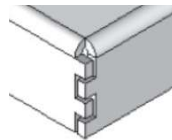

Louvered Corner

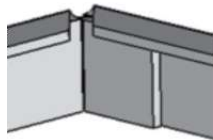

Welded Corner

## ADDITIONAL OPTIONS

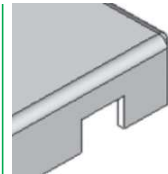

Trace Notch

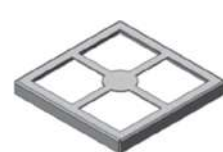

Pick Target



Ventilation Holes



Logo or Part Number Marking

# PERFORMANCE SPECS

### Material Options

- Nickel Silver
- TPS: Tin-Plated Steel
- TPB: Tin-Plated Brass
- TPC: Tin-Plated Copper

### Co-Planarity

- Smaller Shields: 0.004"
- Larger Shields: 0.008"

### Material Thicknesses

- 0.010" (Standard)
- 0.008"
- 0.012"
- 0.015"

### RoHS-Compliant

- Yes

### Shielding Effectiveness

- Up to 60dB

*Other material options include beryllium copper, phosphorus bronze, and stainless steel. Additional plating finishes available upon request.*

*All technical data presented herein is accurate to the best of our knowledge based on Orbel's most up-to-date testing information and material specs. This information is not presented as a warranty or guarantee and is not intended to be all-inclusive as to conditions of use.*