

Ultrafast Rectifier, 15 A FRED Pt[®]

TO-220AC

FEATURES

- Ultrafast and soft recovery time
- Optimized forward voltage drop
- 175 °C maximum operating junction temperature
- Polyimide passivation
- Rugged design
- Good thermal performance
- AEC-Q101 qualified
- Meets JESD 201 class 2 whisker test
- Material categorization: for definitions of compliance please see www.vishay.com/doc?99912

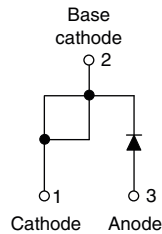

PRODUCT SUMMARY

Package	TO-220AC
$I_{F(AV)}$	15 A
V_R	1200 V
V_F at I_F at 125 °C	2.25 V
t_{rr}	44 ns
T_J max.	175 °C
Diode variation	Single die

DESCRIPTION / APPLICATIONS

Ultrafast recovery rectifiers designed with optimized performance of forward voltage drop, recovery time, and soft recovery. Polyimide passivated, planar structure and the platinum doped life time control guarantee, ruggedness, reliability characteristics, and solid value proposition for efficiency and thermal performance.

These devices are intended for use in boost stage in the AC/DC section of SMPS, high frequency output rectification of battery charger, inverters of solar inverters, or as freewheeling diodes in motor drive.

ABSOLUTE MAXIMUM RATINGS

PARAMETER	SYMBOL	TEST CONDITIONS	VALUES	UNITS
Repetitive peak reverse voltage	V_{RRM}		1200	V
Average rectified forward current	$I_{F(AV)}$	$T_C = 115\text{ °C}$, $D = 0.50$	15	A
Non-repetitive peak surge current	I_{FSM}	$T_C = 25\text{ °C}$, $t_p = 10\text{ ms}$, sine wave	150	
Repetitive peak forward current	I_{FRM}		30	
Operating junction and storage temperature	T_J , T_{Stg}		-55 to +175	°C

ELECTRICAL SPECIFICATIONS ($T_J = 25\text{ °C}$ unless otherwise specified)

PARAMETER	SYMBOL	TEST CONDITIONS	MIN.	TYP.	MAX.	UNITS
Breakdown voltage, blocking voltage	V_{BR} , V_R	$I_R = 250\text{ }\mu\text{A}$	1200	-	-	V
Forward voltage	V_F	$I_F = 15\text{ A}$ $I_F = 15\text{ A}$, $T_J = 125\text{ °C}$	-	2.3 2.25	2.78 2.7	
Reverse leakage current	I_R	$V_R = V_R$ rated $T_J = 125\text{ °C}$, $V_R = V_R$ rated	-	-	80 150	μA
Junction capacitance	C_T	$V_R = 200\text{ V}$	-	13	-	pF
Series inductance	L_S	Measured lead to lead 5 mm from package body	-	8.0	-	nH

DYNAMIC RECOVERY CHARACTERISTICS ($T_J = 25\text{ }^\circ\text{C}$ unless otherwise specified)						
PARAMETER	SYMBOL	TEST CONDITIONS	MIN.	TYP.	MAX.	UNITS
Reverse recovery time	t_{rr}	$I_F = 1.0\text{ A}$, $di_F/dt = 100\text{ A}/\mu\text{s}$, $V_R = 30\text{ V}$	-	44	-	ns
		$T_J = 25\text{ }^\circ\text{C}$	-	167	-	
		$T_J = 125\text{ }^\circ\text{C}$	-	248	-	
Peak recovery current	I_{RRM}	$T_J = 25\text{ }^\circ\text{C}$	-	6	-	A
		$T_J = 125\text{ }^\circ\text{C}$	-	9	-	
Reverse recovery charge	Q_{rr}	$T_J = 25\text{ }^\circ\text{C}$	-	507	-	nC
		$T_J = 125\text{ }^\circ\text{C}$	-	1110	-	

THERMAL - MECHANICAL SPECIFICATIONS						
PARAMETER	SYMBOL	TEST CONDITIONS	MIN.	TYP.	MAX.	UNITS
Thermal resistance, junction to case	R_{thJC}		-	1.1	1.3	$^\circ\text{C}/\text{W}$
Thermal resistance, junction to ambient	R_{thJA}	Typical socket mount	-	54	60	
Thermal resistance, case to heat sink	R_{thCS}	Mounting surface, flat, smooth and greased	-	0.2	0.4	
Weight			-	0.2	-	g
			-	0.07	-	oz.
Mounting torque			6.0 (5.0)	-	12 (10)	kgf · cm (lbf · in)
Maximum junction and storage temperature range	T_J, T_{Stg}		-55	-	175	$^\circ\text{C}$
Marking device		Case style: TO-220AC	15ETU12H			

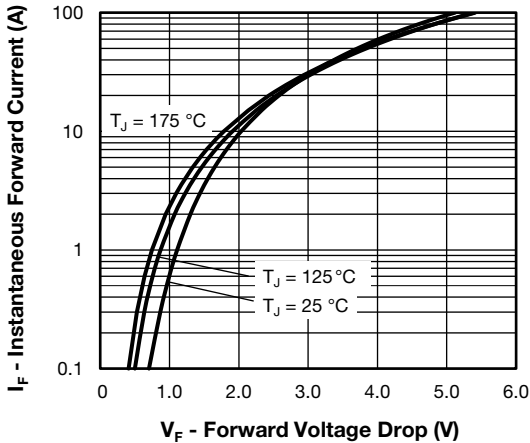

Fig. 1 - Typical Forward Voltage Drop Characteristics

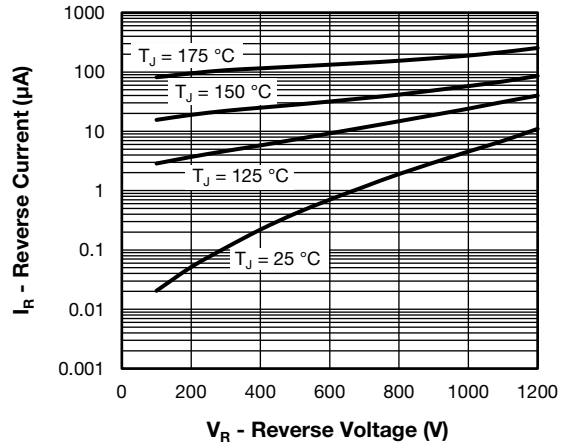

Fig. 2 - Typical Values of Reverse Current vs. Reverse Voltage

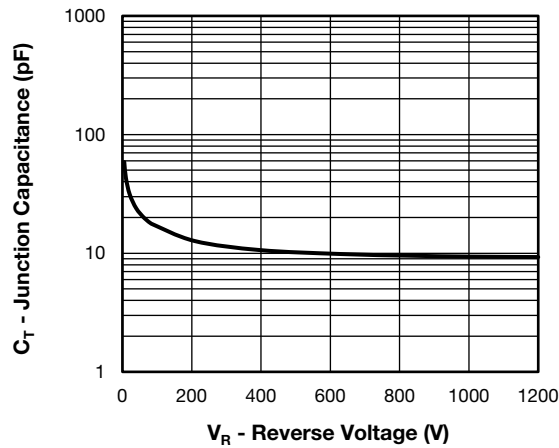

Fig. 3 - Typical Junction Capacitance vs. Reverse Voltage

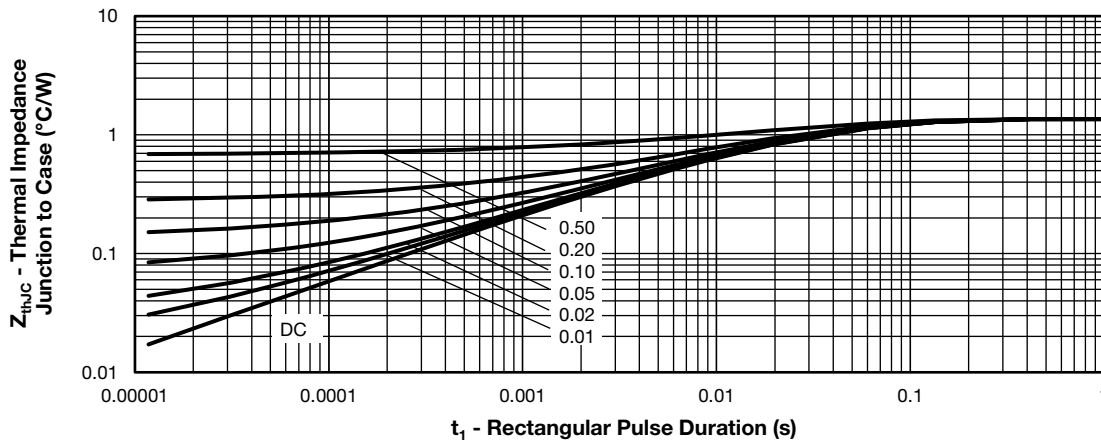

Fig. 4 - Maximum Thermal Impedance Z_{thJC} Characteristics

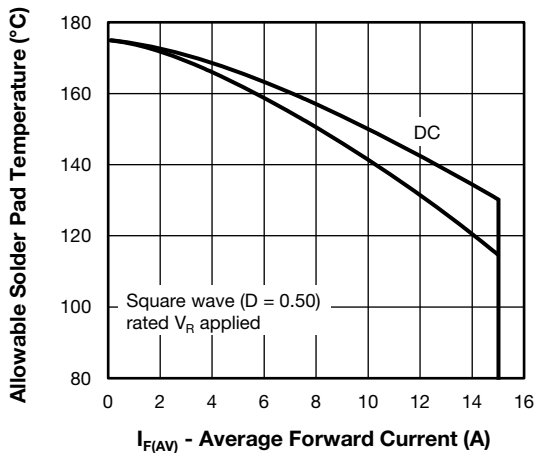

Fig. 5 - Maximum Allowable Case Temperature vs. Average Forward Current

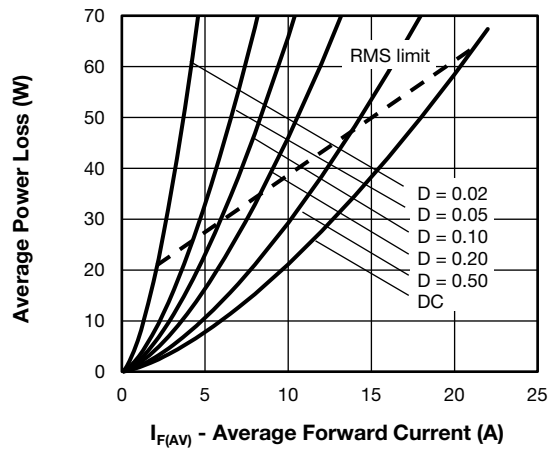

Fig. 6 - Forward Power Loss Characteristics

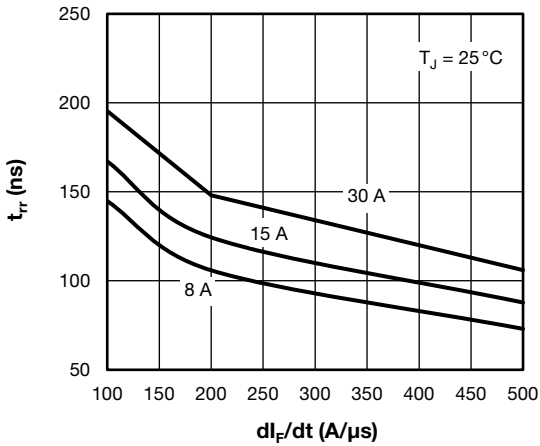

Fig. 7 - Typical Reverse Recovery Time vs. di_F/dt

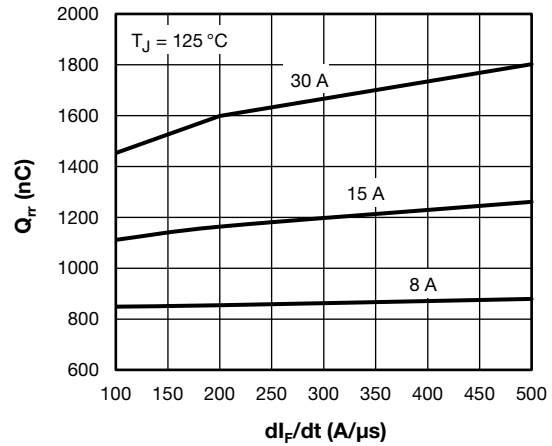

Fig. 10 - Typical Stored Charge vs. di_F/dt

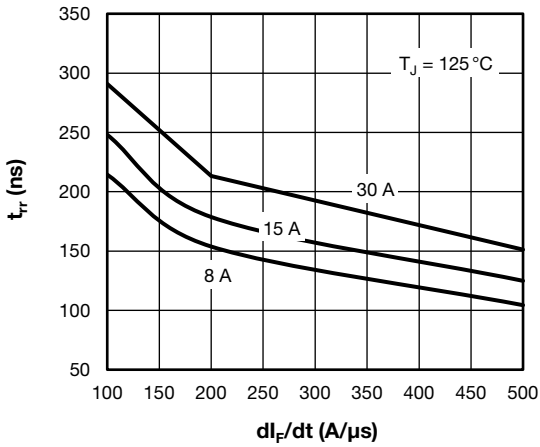

Fig. 8 - Typical Reverse Recovery Time vs. di_F/dt

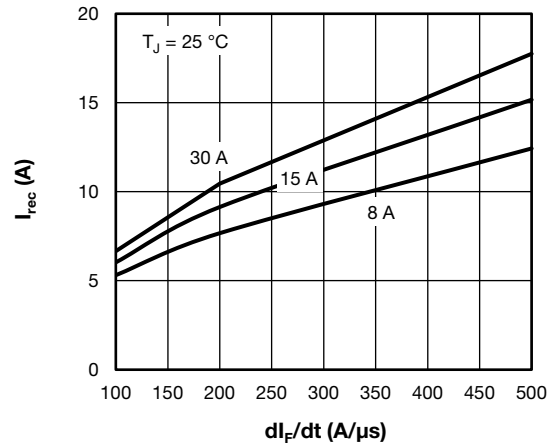

Fig. 11 - Typical Reverse Current vs. di_F/dt

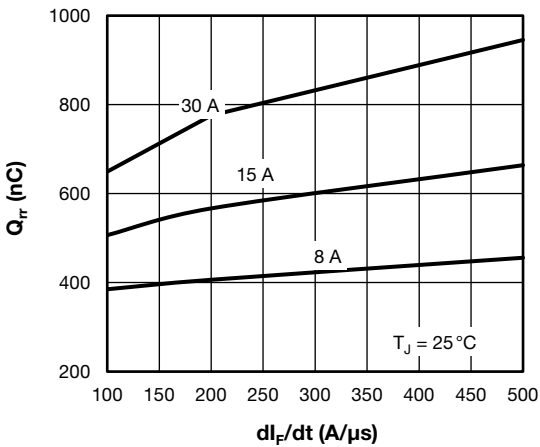

Fig. 9 - Typical Stored Charge vs. di_F/dt

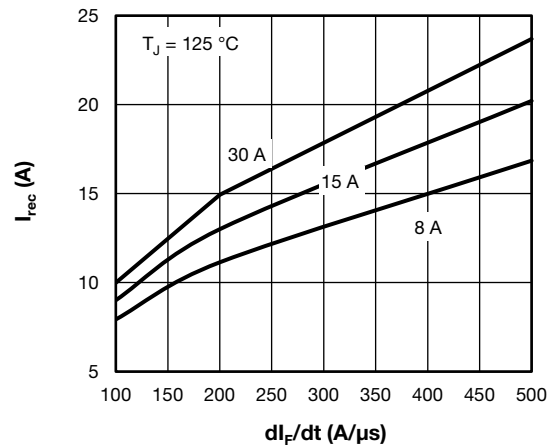
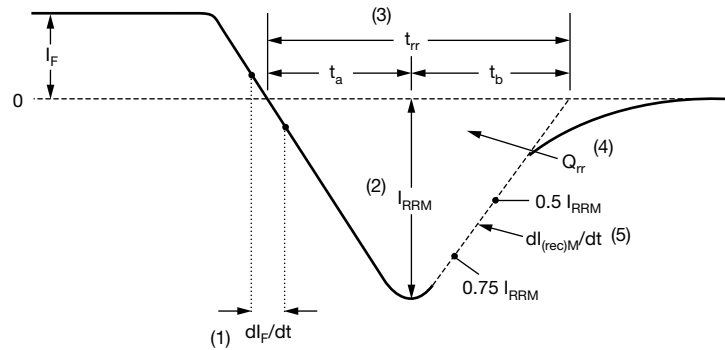

Fig. 12 - Typical Reverse Current vs. di_F/dt



- (1) di_F/dt - rate of change of current through zero crossing
- (2) I_{RRM} - peak reverse recovery current
- (3) t_{rr} - reverse recovery time measured from zero crossing point of negative going I_F to point where a line passing through $0.75 I_{RRM}$ and $0.50 I_{RRM}$ extrapolated to zero current.
- (4) Q_{rr} - area under curve defined by t_{rr} and I_{RRM}
- (5) $di_{(rec)M}/dt$ - peak rate of change of current during t_b portion of t_{rr}

$$Q_{rr} = \frac{t_{rr} \times I_{RRM}}{2}$$

Fig. 13 - Reverse Recovery Waveform and Definitions

ORDERING INFORMATION TABLE

Device code	VS-	15	E	T	U	12	H	N3
	①	②	③	④	⑤	⑥	⑦	⑧

- 1** - Vishay Semiconductors product
- 2** - Current rating (15 = 15 A)
- 3** - E = single diode
- 4** - Package:
- 4** T = TO-220
- 5** - U = ultrafast recovery
- 6** - Voltage rating (12 = 1200 V)
- 7** - H = AEC-Q101 qualified
- 8** - Environmental digit:
-N3 = halogen-free, RoHS-compliant, and totally lead (Pb)-free

ORDERING INFORMATION (Example)			
PREFERRED P/N	QUANTITY PER TUBE	MINIMUM ORDER QUANTITY	PACKAGING DESCRIPTION
VS-15ETU12HN3	50	1000	Antistatic plastic tube

LINKS TO RELATED DOCUMENTS	
Dimensions	www.vishay.com/doc?95221
Part marking information	www.vishay.com/doc?95068

TO-220AC

DIMENSIONS in millimeters and inches

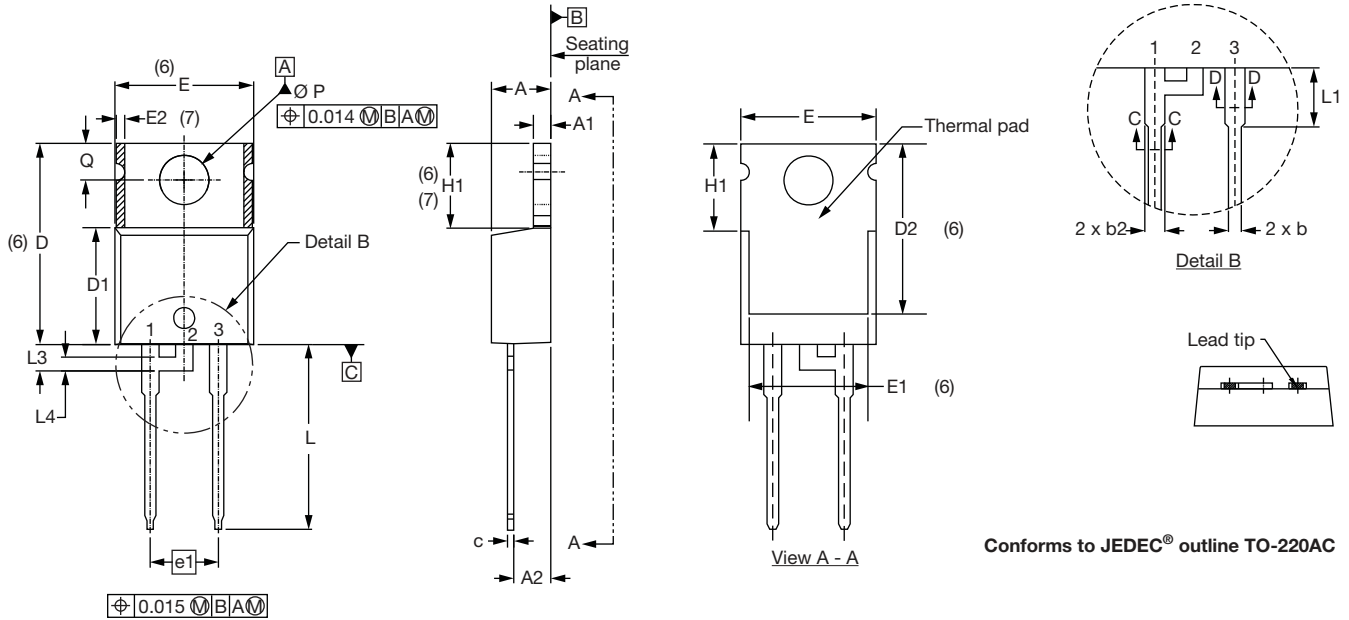

SYMBOL	MILLIMETERS		INCHES		NOTES
	MIN.	MAX.	MIN.	MAX.	
A	4.25	4.65	0.167	0.183	
A1	1.14	1.40	0.045	0.055	
A2	2.56	2.92	0.101	0.115	
b	0.69	1.01	0.027	0.040	
b1	0.38	0.97	0.015	0.038	4
b2	1.20	1.73	0.047	0.068	
b3	1.14	1.73	0.045	0.068	4
c	0.36	0.61	0.014	0.024	
c1	0.36	0.56	0.014	0.022	4
D	14.85	15.25	0.585	0.600	3
D1	8.38	9.02	0.330	0.355	
D2	11.68	12.88	0.460	0.507	6
E	10.11	10.51	0.398	0.414	3, 6

SYMBOL	MILLIMETERS		INCHES		NOTES
	MIN.	MAX.	MIN.	MAX.	
E1	6.86	8.89	0.270	0.350	6
E2	-	0.76	-	0.030	7
e1	4.88	5.28	0.192	0.208	
H1	5.84	6.86	0.230	0.270	6, 7
L	13.52	14.02	0.532	0.552	
L1	3.32	3.82	0.131	0.150	2
L3	1.78	2.13	0.070	0.084	
L4	0.76	1.27	0.030	0.050	2
Ø P	3.54	3.73	0.139	0.147	
Q	2.60	3.00	0.102	0.118	

Notes

- (1) Dimensioning and tolerancing as per ASME Y14.5M-1994
- (2) Lead dimension and finish uncontrolled in L1
- (3) Dimension D, D1 and E do not include mold flash. Mold flash shall not exceed 0.127 mm (0.005") per side. These dimensions are measured at the outermost extremes of the plastic body
- (4) Dimension b1, b3 and c1 apply to base metal only
- (5) Controlling dimension: inches
- (6) Thermal pad contour optional within dimensions E, H1, D2 and E1
- (7) Dimension E2 x H1 define a zone where stamping and singulation irregularities are allowed
- (8) Outline conforms to JEDEC TO-220, D2 (minimum) where dimensions are derived from the actual package outline



Disclaimer

ALL PRODUCT, PRODUCT SPECIFICATIONS AND DATA ARE SUBJECT TO CHANGE WITHOUT NOTICE TO IMPROVE RELIABILITY, FUNCTION OR DESIGN OR OTHERWISE.

Vishay Intertechnology, Inc., its affiliates, agents, and employees, and all persons acting on its or their behalf (collectively, "Vishay"), disclaim any and all liability for any errors, inaccuracies or incompleteness contained in any datasheet or in any other disclosure relating to any product.

Vishay makes no warranty, representation or guarantee regarding the suitability of the products for any particular purpose or the continuing production of any product. To the maximum extent permitted by applicable law, Vishay disclaims (i) any and all liability arising out of the application or use of any product, (ii) any and all liability, including without limitation special, consequential or incidental damages, and (iii) any and all implied warranties, including warranties of fitness for particular purpose, non-infringement and merchantability.

Statements regarding the suitability of products for certain types of applications are based on Vishay's knowledge of typical requirements that are often placed on Vishay products in generic applications. Such statements are not binding statements about the suitability of products for a particular application. It is the customer's responsibility to validate that a particular product with the properties described in the product specification is suitable for use in a particular application. Parameters provided in datasheets and / or specifications may vary in different applications and performance may vary over time. All operating parameters, including typical parameters, must be validated for each customer application by the customer's technical experts. Product specifications do not expand or otherwise modify Vishay's terms and conditions of purchase, including but not limited to the warranty expressed therein.

Hyperlinks included in this datasheet may direct users to third-party websites. These links are provided as a convenience and for informational purposes only. Inclusion of these hyperlinks does not constitute an endorsement or an approval by Vishay of any of the products, services or opinions of the corporation, organization or individual associated with the third-party website. Vishay disclaims any and all liability and bears no responsibility for the accuracy, legality or content of the third-party website or for that of subsequent links.

Except as expressly indicated in writing, Vishay products are not designed for use in medical, life-saving, or life-sustaining applications or for any other application in which the failure of the Vishay product could result in personal injury or death. Customers using or selling Vishay products not expressly indicated for use in such applications do so at their own risk. Please contact authorized Vishay personnel to obtain written terms and conditions regarding products designed for such applications.

No license, express or implied, by estoppel or otherwise, to any intellectual property rights is granted by this document or by any conduct of Vishay. Product names and markings noted herein may be trademarks of their respective owners.