

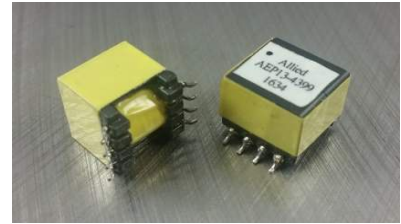

EP13 Transformer

AEP13-4399



- Operating temperature range: -40°C to +90°C
- EP13 SMD Package

Electrical Specifications @25°C				
Inductance 10KHz, 0.1V (1-4)	Leakage Inductance @ 100KHz, 0.02V (1-4) (Short Pins 5, 6, 7, and 8)		Turns Ratio (1-4):(6-8)	Turns Ratio (1-4):(5-7)
40µH±10%	400nH Typ	1.0µH Max	1:1±1%	1:1±1%
Electrical Specifications @25°C				
DCR (1-4) mΩ Max	DCR (5-7) mΩ Max	DCR (6-8) mΩ Max	Hi-Pot (1-8)	Hi-Pot (1-7)
80	185	185	1500VAC, 60S 1875VAC, 1S	1500VAC, 60S 1875VAC, 1S

All specifications subject to change without notice.

MECHANICAL

Dimensions: $\frac{\text{mm}}{\text{(inches)}}$

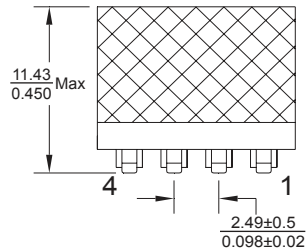

FRONT VIEW

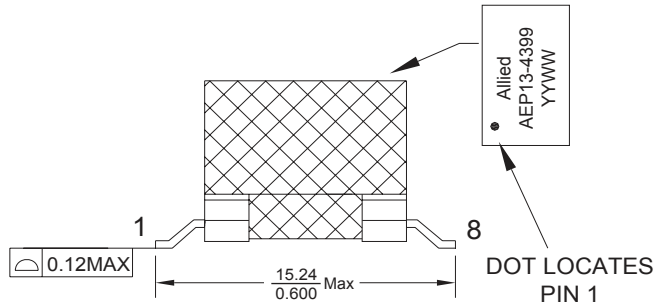

SIDE VIEW

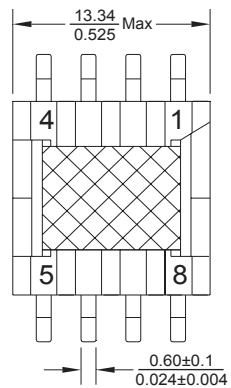

BOTTOM VIEW

SCHEMATICS

