

## ML-XT CV CONNECTOR SYSTEM

### 1.0 SCOPE

This specification specifies the general requirements to describe the automated packaging procedure for the ML-XT CV Connector system, series: 93444, 93445, 93446, 93447 & 93448.

### 2.0 PURPOSE

The purpose of this specification is to ensure that all connectors shipped from Molex arrive damage free and in a manner which allows ease of handling, storage and distribution.

### 3.0 GENERAL PACKAGING INFORMATION

The recommended carton closure is box tape applied to the top and bottom faces.

The carton weight should not exceed 15kg.

### 4.0 PACKAGING OF PARTS

#### 4.1 PACKAGING OF PARTS IN BAGS

The connector is placed in a heat-sealed bag; refer to table 2 for bag part number.

The relevant drawings are:

Drawing	Description
934430010 PSD	2CCT ML-XT Sales Drawing
934430020 PSD	3CCT ML-XT Sales Drawing
934430030 PSD	4CCT ML-XT Sales Drawing
934430040 PSD	6CCT ML-XT Sales Drawing
934430050 PSD	8CCT ML-XT Sales Drawing
934430060 PSD	12CCT ML-XT Sales Drawing
934430070 PSD	18CCT ML-XT Sales Drawing

Table 1: Relevant Drawings

Part Numbers for packaging are as follows:

Packaging Item	Part Number	Description	Dimensions
Poly Bag	1211160012	Plastic Bag for Assemblies with Heatshrink Adaptor	W=365, H=200
Foil	908481458	Plastic Foil that makes Bag for Receptacle/Plug Assemblies	W = 500/2, L = See Table 3
Poly Bag	1211160012	Plastic Bag for Wedgelocks	W=365, H=200
Carton	967070007	Carton for Receptacle/Plug Assemblies	W=364, L=364, H=176
Carton	967070001	Carton For 8cct Plug Assemblies with Heatshrink Adaptor	W=176, L=363, H=176
Carton	967070005	Carton For Wedgelocks	W=165, L=168, H=160

Table 2: Packaging Material Part Numbers

REVISION: <b>B</b>	ECR/ECN INFORMATION: EC No: <b>605924</b> DATE:	TITLE: <b>ML-XT CV CONNECTOR SYSTEM PACKAGING SPECIFICATION</b>	SHEET No. <b>1 of 12</b>
DOCUMENT NUMBER: <b>934430002/PS/K/B</b>	CREATED / REVISED BY: <b>JFLETCHER</b>	CHECKED BY:	APPROVED BY:

## 4.2 PACKING INSTRUCTIONS



Figure 1: Components Placed in Bag

Note: No mixed part numbers allowed

The recommended quantities of parts are placed in the bag. The bag is then heat sealed and a Molex label is then printed on the outside of the bag. The label must adequately describe the product details and factory order information. See Table 3 for packing information of connectors with and without Heatshrink adaptor.

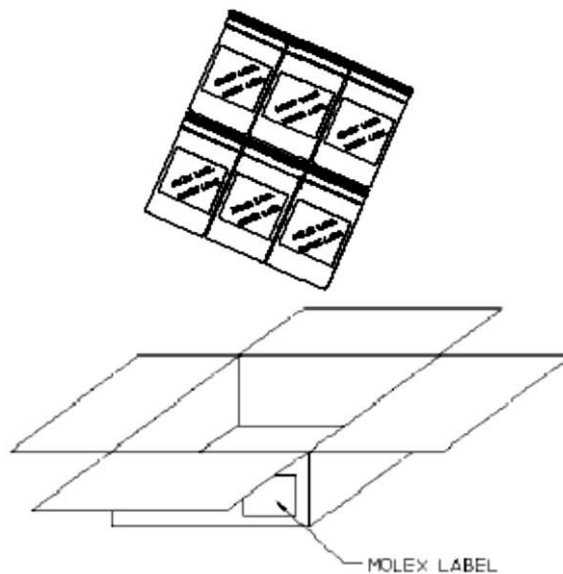

Figure 2: Bags Placed in Carton

REVISION: <b>B</b>	ECR/ECN INFORMATION: EC No: <b>605924</b> DATE:	TITLE: <b>ML-XT CV CONNECTOR SYSTEM PACKAGING SPECIFICATION</b>	SHEET No. <b>2 of 12</b>
DOCUMENT NUMBER: <b>934430002/PS/K/B</b>	CREATED / REVISED BY: <b>JFLETCHER</b>	CHECKED BY:	APPROVED BY:

### 2CCT ML-XT RECEPTACLE CONNECTOR PACKAGING

Material No.	Description	No. of Bags	QTY Per Bag	QTY Per Carton	Plastic Bag/Foil P/N	Length of Foil (mm)	Carton P/N	M.O.Q
93444-1***	2cct Receptacle Variation	10	100	1000	908481458	365	967070007	1000

### 2CCT ML-XT PLUG CONNECTOR PACKAGING

Material No.	Description	No. of Bags	QTY Per Bag	QTY Per Carton	Plastic Bag/Foil P/N	Length of Foil (mm)	Carton P/N	M.O.Q
93445-1***	2cct Plug Variation	10	100	1000	908481458	365	967070007	1000

### 2CCT ML-XT RECEPTACLE CONNECTOR WITH HEATSHRINK ADAPTOR PACKAGING

Material No.	Description	No. of Bags	QTY Per Bag	QTY Per Carton	Plastic Bag/Foil P/N	Carton P/N	M.O.Q
93444-1***	2cct Recep (w/Heatshrink) Variation	10	100	1000	1211160012	967070007	1000

### 2CCT ML-XT PLUG CONNECTOR WITH HEATSHRINK ADAPTOR PACKAGING

Material No.	Description	No. of Bags	QTY Per Bag	QTY Per Carton	Plastic Bag/Foil P/N	Carton P/N	M.O.Q
93445-1***	2cct Plug (w/Heatshrink) Variation	10	100	1000	1211160012	967070007	1000

### 3CCT ML-XT RECEPTACLE CONNECTOR PACKAGING

Material No.	Description	No. of Bags	QTY Per Bag	QTY Per Carton	Plastic Bag/Foil P/N	Length of Foil (mm)	Carton P/N	M.O.Q
93444-2***	3cct Receptacle Variation	8	100	800	908481458	365	967070007	800

### 3CCT ML-XT PLUG CONNECTOR PACKAGING

Material No.	Description	No. of Bags	QTY Per Bag	QTY Per Carton	Plastic Bag/Foil P/N	Length of Foil (mm)	Carton P/N	M.O.Q
93445-2***	3cct Plug Variation	10	100	1000	908481458	365	967070007	1000

REVISION: <b>B</b>	ECR/ECN INFORMATION: EC No: <b>605924</b> DATE:	TITLE: <b>ML-XT CV CONNECTOR SYSTEM PACKAGING SPECIFICATION</b>	SHEET No. <b>3 of 12</b>
DOCUMENT NUMBER: <b>934430002/PS/K/B</b>	CREATED / REVISED BY: <b>JFLETCHER</b>	CHECKED BY:	APPROVED BY:

### 3CCT ML-XT RECEPTACLE CONNECTOR WITH HEATSHRINK ADAPTOR PACKAGING

Material No.	Description	No. of Bags	QTY Per Bag	QTY Per Carton	Plastic Bag/Foil P/N	Carton P/N	M.O.Q
93444-2***	3cct Recep (w/Heatshrink) Variation	10	50	500	1211160012	967070007	500

### 3CCT ML-XT PLUG CONNECTOR WITH HEATSHRINK ADAPTOR PACKAGING

Material No.	Description	No. of Bags	QTY Per Bag	QTY Per Carton	Plastic Bag/Foil P/N	Carton P/N	M.O.Q
93445-2***	3cct Plug (w/Heatshrink) Variation	10	50	500	1211160012	967070007	500

### 4CCT ML-XT RECEPTACLE CONNECTOR PACKAGING

Material No.	Description	No. of Bags	QTY Per Bag	QTY Per Carton	Plastic Bag/Foil P/N	Length of Foil (mm)	Carton P/N	M.O.Q
93444-3***	4cct Receptacle Variation	10	50	500	908481458	365	967070007	1000

### 4CCT ML-XT PLUG CONNECTOR PACKAGING

Material No.	Description	No. of Bags	QTY Per Bag	QTY Per Carton	Plastic Bag/Foil P/N	Length of Foil (mm)	Carton P/N	M.O.Q
93445-3***	4cct Plug Variation	10	100	1000	908481458	365	967070007	1000

### 4CCT ML-XT RECEPTACLE CONNECTOR WITH HEATSHRINK ADAPTOR PACKAGING

Material No.	Description	No. of Bags	QTY Per Bag	QTY Per Carton	Plastic Bag/Foil P/N	Carton P/N	M.O.Q
93444-3***	4cct Recep (w/Heatshrink) Variation	10	50	500	1211160012	967070007	500

### 4CCT ML-XT PLUG CONNECTOR WITH HEATSHRINK ADAPTOR PACKAGING

Material No.	Description	No. of Bags	QTY Per Bag	QTY Per Carton	Plastic Bag/Foil P/N	Carton P/N	M.O.Q
93445-3***	4cct Plug (w/Heatshrink) Variation	10	50	500	1211160012	967070007	500

REVISION: <b>B</b>	ECR/ECN INFORMATION: EC No: <b>605924</b> DATE:	TITLE: <b>ML-XT CV CONNECTOR SYSTEM PACKAGING SPECIFICATION</b>	SHEET No. <b>4 of 12</b>
DOCUMENT NUMBER: <b>934430002/PS/K/B</b>	CREATED / REVISED BY: <b>JFLETCHER</b>	CHECKED BY:	APPROVED BY:

### 6CCT ML-XT RECEPTACLE CONNECTOR PACKAGING

Material No.	Description	No. of Bags	QTY Per Bag	QTY Per Carton	Plastic Bag/Foil P/N	Length of Foil (mm)	Carton P/N	M.O.Q
93444-4***	6cct Receptacle Variation	10	50	500	908481458	365	967070007	1000

### 6CCT ML-XT PLUG CONNECTOR PACKAGING

Material No.	Description	No. of Bags	QTY Per Bag	QTY Per Carton	Plastic Bag/Foil P/N	Length of Foil (mm)	Carton P/N	M.O.Q
93445-4***	6cct Plug Variation	10	50	500	908481458	365	967070007	1000

### 6CCT ML-XT RECEPTACLE CONNECTOR WITH HEATSHRINK ADAPTOR PACKAGING

Material No.	Description	No. of Bags	QTY Per Bag	QTY Per Carton	Plastic Bag/Foil P/N	Carton P/N	M.O.Q
93444-4***	6cct Recep (w/Heatshrink) Variation	10	50	500	1211160012	967070007	500

### 6CCT ML-XT PLUG CONNECTOR WITH HEATSHRINK ADAPTOR PACKAGING

Material No.	Description	No. of Bags	QTY Per Bag	QTY Per Carton	Plastic Bag/Foil P/N	Carton P/N	M.O.Q
93445-4***	6cct Plug (w/Heatshrink) Variation	10	50	500	1211160012	967070007	500

### 8CCT ML-XT RECEPTACLE CONNECTOR PACKAGING

Material No.	Description	No. of Bags	QTY Per Bag	QTY Per Carton	Plastic Bag/Foil P/N	Length of Foil (mm)	Carton P/N	M.O.Q
93444-5***	8cct Receptacle Variation	6	50	300	908481458	365	967070007	600

### 8CCT ML-XT PLUG CONNECTOR PACKAGING

Material No.	Description	No. of Bags	QTY Per Bag	QTY Per Carton	Plastic Bag/Foil P/N	Length of Foil (mm)	Carton P/N	M.O.Q
93445-5***	8cct Plug Variation	10	50	500	908481458	365	967070007	500

REVISION: <b>B</b>	ECR/ECN INFORMATION: EC No: <b>605924</b> DATE:	TITLE: <b>ML-XT CV CONNECTOR SYSTEM PACKAGING SPECIFICATION</b>	SHEET No. <b>5 of 12</b>
DOCUMENT NUMBER: <b>934430002/PS/K/B</b>	CREATED / REVISED BY: <b>JFLETCHER</b>	CHECKED BY:	APPROVED BY:

### 8CCT ML-XT RECEPTACLE CONNECTOR WITH HEATSHRINK ADAPTOR PACKAGING

Material No.	Description	No. of Bags	QTY Per Bag	QTY Per Carton	Plastic Bag/Foil P/N	Carton P/N	M.O.Q
93444-5***	8cct Recep (w/Heatshrink) Variation	10	30	300	1211160012	967070007	300

### 8CCT ML-XT PLUG CONNECTOR WITH HEATSHRINK ADAPTOR PACKAGING

Material No.	Description	No. of Bags	QTY Per Bag	QTY Per Carton	Plastic Bag/Foil P/N	Carton P/N	M.O.Q
93445-5***	8cct Plug (w/Heatshrink) Variation	5	40	200	1211160012	967070001	400

### 12CCT ML-XT RECEPTACLE CONNECTOR PACKAGING

Material No.	Description	No. of Bags	QTY Per Bag	QTY Per Carton	Plastic Bag/Foil P/N	Length of Foil (mm)	Carton P/N	M.O.Q
93444-6***	12cct Receptacle Variation	10	25	250	908481458	365	967070007	500

### 12CCT ML-XT PLUG CONNECTOR PACKAGING

Material No.	Description	No. of Bags	QTY Per Bag	QTY Per Carton	Plastic Bag/Foil P/N	Length of Foil (mm)	Carton P/N	M.O.Q
93445-6***	12cct Plug Variation	8	50	400	908481458	365	967070007	400

### 12CCT ML-XT RECEPTACLE CONNECTOR WITH HEATSHRINK ADAPTOR PACKAGING

Material No.	Description	No. of Bags	QTY Per Bag	QTY Per Carton	Plastic Bag/Foil P/N	Carton P/N	M.O.Q
93444-6***	12cct Recep (w/Heatshrink) Variation	8	25	200	1211160012	967070007	200

### 12CCT ML-XT PLUG CONNECTOR WITH HEATSHRINK ADAPTOR PACKAGING

Material No.	Description	No. of Bags	QTY Per Bag	QTY Per Carton	Plastic Bag/Foil P/N	Carton P/N	M.O.Q
93445-6***	12cct Plug (w/Heatshrink) Variation	12	25	300	1211160012	967070007	300

REVISION: <b>B</b>	ECR/ECN INFORMATION: EC No: <b>605924</b> DATE:	TITLE: <b>ML-XT CV CONNECTOR SYSTEM PACKAGING SPECIFICATION</b>	SHEET No. <b>6 of 12</b>
DOCUMENT NUMBER: <b>934430002/PS/K/B</b>	CREATED / REVISED BY: <b>JFLETCHER</b>	CHECKED BY:	APPROVED BY:

18CCT ML-XT RECEPTACLE CONNECTOR PACKAGING								
Material No.	Description	No. of Bags	QTY Per Bag	QTY Per Carton	Plastic Bag/Foil P/N	Length of Foil (mm)	Carton P/N	M.O.Q
93444-7***	18cct Receptacle Variation	6	50	300	908481458	365	967070007	600

18CCT ML-XT PLUG CONNECTOR PACKAGING								
Material No.	Description	No. of Bags	QTY Per Bag	QTY Per Carton	Plastic Bag/Foil P/N	Length of Foil (mm)	Carton P/N	M.O.Q
93445-7***	18cct Plug Variation	8	50	400	908481458	365	967070007	400

18CCT ML-XT RECEPTACLE CONNECTOR WITH HEATSHRINK ADAPTOR PACKAGING								
Material No.	Description	No. of Bags	QTY Per Bag	QTY Per Carton	Plastic Bag/Foil P/N	Carton P/N	M.O.Q	
93444-7***	18cct Recep (w/Heatshrink) Variation	10	25	250	1211160012	967070007	250	

18CCT ML-XT PLUG CONNECTOR WITH HEATSHRINK ADAPTOR PACKAGING								
Material No.	Description	No. of Bags	QTY Per Bag	QTY Per Carton	Plastic Bag/Foil P/N	Carton P/N	M.O.Q	
93445-7***	18cct Plug (w/Heatshrink) Variation	10	25	250	1211160012	967070007	250	

Table 3: Packaging Information of Connectors



REVISION: <b>B</b>	ECR/ECN INFORMATION: EC No: <b>605924</b> DATE:	TITLE: <b>ML-XT CV CONNECTOR SYSTEM PACKAGING SPECIFICATION</b>	SHEET No. <b>7 of 12</b>
DOCUMENT NUMBER: <b>934430002/PS/K/B</b>	CREATED / REVISED BY: <b>JFLETCHER</b>	CHECKED BY:	APPROVED BY:

Material No.	Circuit Size	No. Of Bags	QTY Per Carton	QTY Per Bag	Description	PLASTIC BAG P/N	Carton P/N	M.O.Q
93447-1***	2	1	1000	1000	2cct Receptacle Wedglock	1211160012	967070005	1000
93447-2***	3	1	1000	1000	3cct Receptacle Wedglock	1211160012	967070005	1000
93447-3***	4	1	1000	1000	4cct Receptacle Wedglock	1211160012	967070005	1000
93447-4***	6	1	1000	1000	6cct Receptacle Wedglock	1211160012	967070005	1000
93447-5***	8	1	500	500	8cct Receptacle Wedglock	1211160012	967070005	500
93447-6***	12	1	500	500	12cct Receptacle Wedglock	1211160012	967070005	500
93448-1***	2	1	1000	1000	2cct Plug Wedglock	1211160012	967070005	1000
93448-2***	3	1	1000	1000	3cct Plug Wedglock	1211160012	967070005	1000
93448-3***	4	1	1000	1000	4cct Plug Wedglock	1211160012	967070005	1000
93448-4***	6	2	1000	500	6cct Plug Wedglock	1211160012	967070005	1000
93448-5***	8	2	500	250	8cct Plug Wedglock	1211160012	967070005	500
93448-6***	12	2	500	250	12cct Plug Wedglock	1211160012	967070005	500

Table 4: Packaging Information of Wedglocks

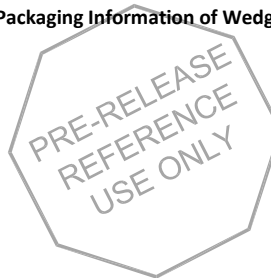

REVISION: <b>B</b>	ECR/ECN INFORMATION: EC No: <b>605924</b> DATE:	TITLE: <b>ML-XT CV CONNECTOR SYSTEM PACKAGING SPECIFICATION</b>	SHEET No. <b>8 of 12</b>
DOCUMENT NUMBER: <b>934430002/PS/K/B</b>	CREATED / REVISED BY: <b>JFLETCHER</b>	CHECKED BY:	APPROVED BY:



Note: No mixed part numbers allowed

The specified numbers of bags are placed inside the carton. Bubble wrap or similar packaging filler is used to take up any free space inside the carton. A standard Molex label is placed on the outside of the carton as per Figures 3 & 4. The label must adequately describe the product details and factory order information.

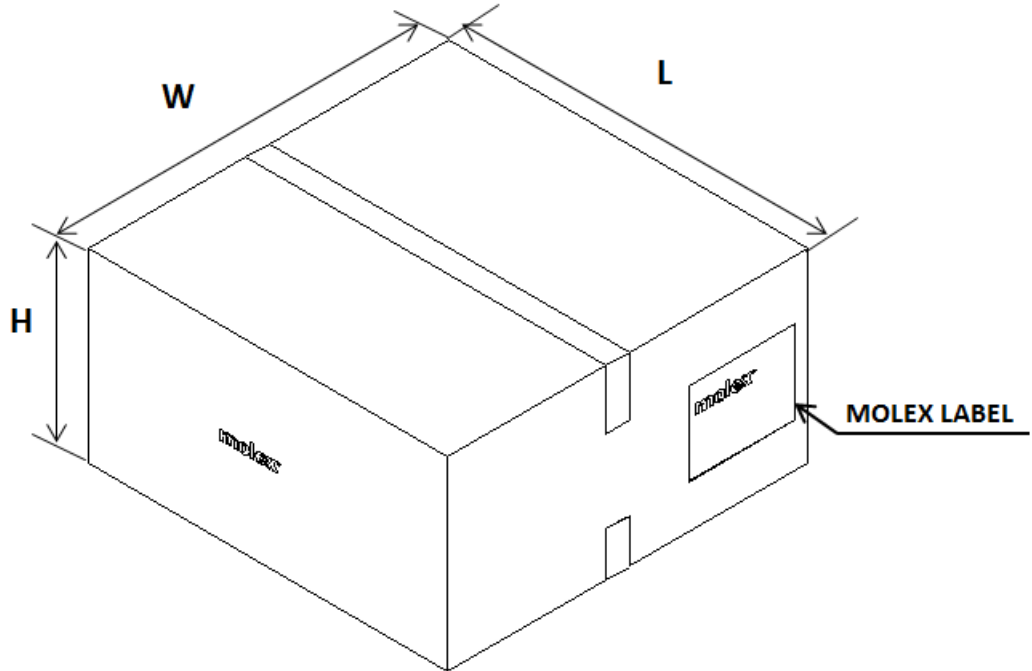

Figure 3: Label Position on Carton 967070007

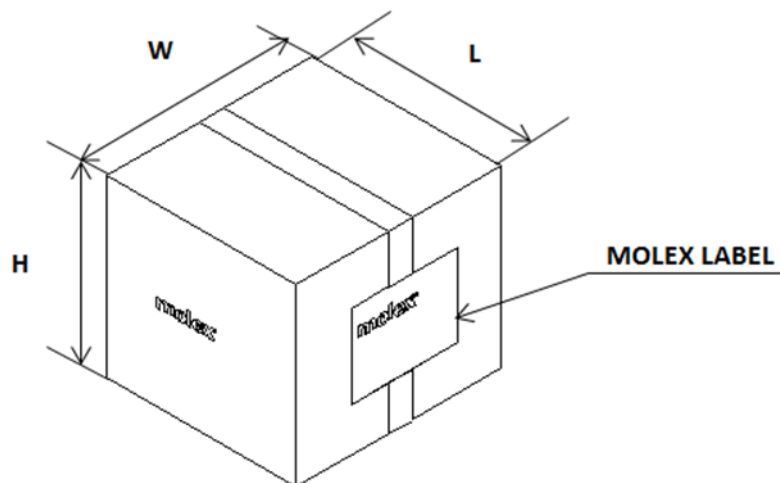

Figure 4: Label Position on Carton 967070005

REVISION: <b>B</b>	ECR/ECN INFORMATION: EC No: <b>605924</b> DATE:	TITLE: <b>ML-XT CV CONNECTOR SYSTEM PACKAGING SPECIFICATION</b>	SHEET No. <b>9 of 12</b>
DOCUMENT NUMBER: <b>934430002/PS/K/B</b>	CREATED / REVISED BY: <b>JFLETCHER</b>	CHECKED BY:	APPROVED BY:

## 5.0 PACKAGING OF CARTONS ON PALLET

The Pallet is a standard EUR-SIZE PALLET per 916871001.

Loaded pallet is shrink wrapped to ensure cartons are secure on the pallet

**Pallets of cartons may not be stacked on top of one another.**

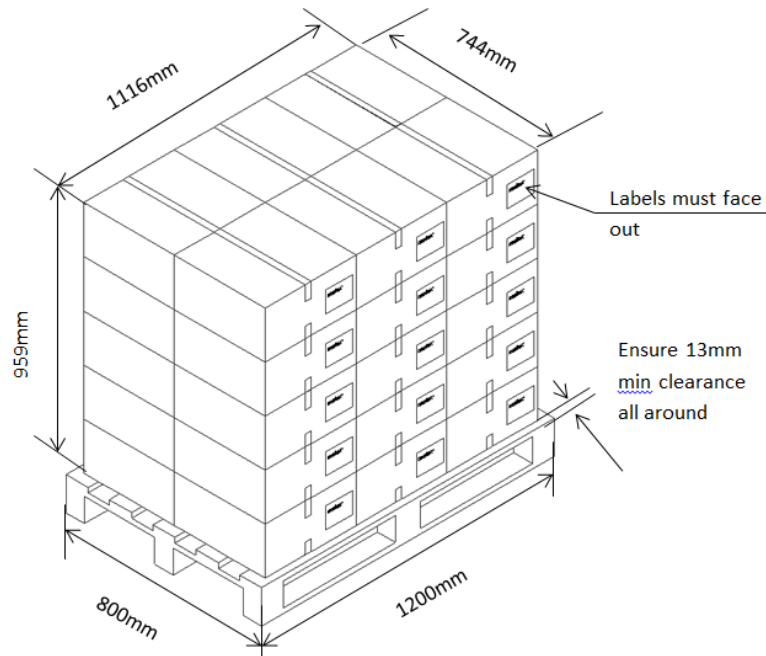

Figure 5: 967070007 Cartons on Pallet

Carton Part Number	Cartons Per Pallet	Stacked (No. of cartons)
967070007	30	5 x 3 x 2
967070001	60	5 x 6 x 2
967070005	120	5 x 6 x 4

Table 5: Cartons per Pallet

MATERIAL NO.	CIRCUIT SIZE	MAX QTY PER PALLET	DESCRIPTION
93444-1***	2cct	30000	Receptacle variation
93445-1***	2cct	30000	Plug variation
93444-2***	3cct	30000/15000*	Receptacle variation
93445-2***	3cct	30000/15000*	Plug variation
93444-3***	4cct	15000	Receptacle variation

REVISION: <b>B</b>	ECR/ECN INFORMATION: EC No: <b>605924</b> DATE:	TITLE: <b>ML-XT CV CONNECTOR SYSTEM PACKAGING SPECIFICATION</b>	SHEET No. <b>10 of 12</b>
DOCUMENT NUMBER: <b>934430002/PS/K/B</b>	CREATED / REVISED BY: <b>JFLETCHER</b>	CHECKED BY:	APPROVED BY:

MATERIAL NO.	CIRCUIT SIZE	MAX QTY PER PALLET	DESCRIPTION
93445-3***	4cct	30000/15000*	Plug variation
93444-4***	6cct	15000	Receptacle variation
93445-4***	6cct	15000	Plug variation
93444-5***	8cct	12000/9000*	Receptacle variation
93445-5***	8cct	15000/12000*	Plug variation
93444-6***	12cct	9000/6000*	Receptacle variation
93445-6***	12cct	12000/9000*	Plug variation
93444-7***	18cct	9000/7500*	Receptacle variation
93445-7***	18cct	12000/7500*	Plug variation
93447-1***	2cct	120000	Receptacle wedgelock
93448-1***	2cct	120000	Plug wedgelock
93447-2***	3cct	120000	Receptacle wedgelock
93448-2***	3cct	120000	Plug wedgelock
93447-3***	4cct	120000	Receptacle wedgelock
93448-3***	4cct	120000	Plug wedgelock
93447-4***	6cct	120000	Receptacle wedgelock
93448-4***	6cct	120000	Plug wedgelock
93447-5***	8cct	60000	Receptacle wedgelock
93448-5***	8cct	60000	Plug wedgelock
93447-6***	12cct	60000	Receptacle wedgelock
93448-6***	12cct	60000	Plug wedgelock

\*Connector with Heatshrink Adaptor Quantity

Table 6: Component Quantity per Pallet



REVISION: <b>B</b>	ECR/ECN INFORMATION: EC No: <b>605924</b> DATE:	TITLE: <b>ML-XT CV CONNECTOR SYSTEM PACKAGING SPECIFICATION</b>	SHEET No. <b>11 of 12</b>
DOCUMENT NUMBER: <b>934430002/PS/K/B</b>	CREATED / REVISED BY: <b>JFLETCHER</b>	CHECKED BY:	APPROVED BY:

## 6.0 LABELLING

The Molex labels to be used on Cartons and Bag No. 1211160012 are the standard Molex Ireland labels (127.0 x 76.2mm).







(1P) PART NUMBER <b>0934451101</b> 	(9D) DATE CODE <b>1514</b> 	
DESCRIPTION <b>2CCT ML-XT PLUG BLACK W SMALL SEAL ASSY</b>	 <a href="http://www.molex.com">www.molex.com</a>	
(Q) QUANTITY <b>100</b> 		
(12D) INV CTRL DATE <b>2015/05/01</b>		
(4L) COUNTRY OF ORIGIN <b>Ireland</b>		
(1T) TRACEABILITY <b>000841771308</b> 		
ELV and RoHS Compliant REACH SVHC information - see <a href="http://www.molex.com">www.molex.com</a>		
BATCH Nr. <b>VS1</b>		Pack Std <b>1/*</b>
Eng. Nr. <b>934451101</b>		100/1000 OUTER
Customer P/N <b>0934451101</b>		
MOLEX IRELAND LTD., SHANNON INDUSTRIAL ESTATE, SHANNON, CO.CLARE, IRELAND		

Figure 6: Sample ML-XT Carton Label

The Molex labels to be used on Bags 908481458 are printed directly onto the bag as they are packaged off the machine. (68.00mm x 46.00mm).

**Note:** Molex standard labels (127.0 x 76.2mm) may also be used on bag 908481458

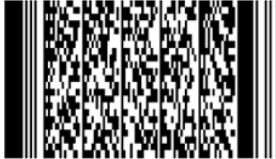

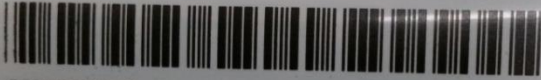

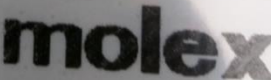
(1P) PART NUMBER **0123456789**  
  
 DESCRIPTION **2CCT ML-XT RECP BLACK W SML SEAL**  
 (Q) QUANTITY **XXX**  
 **1/\***  
 (1T) TRACEABILITY **000987654321**  
 **1/\***  
 BATCH Nr. **XXXX** VS **111** | DATE :  

Figure 7: Sample ML-XT Bag Label

REVISION: <b>B</b>	ECR/ECN INFORMATION: EC No: <b>605924</b> DATE:	TITLE: <b>ML-XT CV CONNECTOR SYSTEM PACKAGING SPECIFICATION</b>	SHEET No. <b>12 of 12</b>
DOCUMENT NUMBER: <b>934430002/PS/K/B</b>	CREATED / REVISED BY: <b>JFLETCHER</b>	CHECKED BY:	APPROVED BY: