

DATA SHEET

# SMS7621-060: Surface-Mount, 0201 Low-Barrier Silicon Schottky Diode

## Applications

- Sensitive detector circuits
- Sampling circuits
- Mixer circuits

## Features

- Low barrier height
- Suitable for use above 26 GHz
- Low parasitic impedance:  $C_P < 0.05$  pF,  $L_s < 0.2$  nH
- Low profile, ultra-miniature 0201 SMT package (MSL1, 260 °C per JEDEC J-STD-020)



## Description

The SMS7621-060 is a silicon, low-barrier N-type Schottky diode with an ultra-miniature 0201 footprint. This diode can be used in detector circuits, sampling circuits, and mixer circuits.

The low series resistance of this low-barrier diode enables good performance as a low-level mixer at frequencies up to 26 GHz and higher.

A pinout diagram for the SMS7621-060 is shown in Figure 1.



Skyworks Green™ products are compliant with all applicable legislation and are halogen-free. For additional information, refer to *Skyworks Definition of Green™*, document number SQ04-0074.

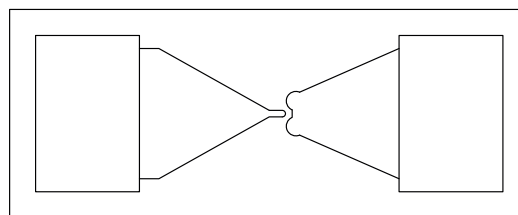

Bottom View



Top View

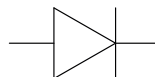

Y1951

**Figure 1. SMS7621-060 Pinout Diagram**

## Mixer and Detector Applications

### 24 GHz Detector Design

A detector circuit that incorporates an SMS7621-060 Schottky diode and covers the 24 GHz band is shown in Figure 2. The RF arrives on a 50 Ω microstrip line from the left and is shorted to GND by a 90 degree line with a stub (GND arrives by a via).

The cathode of the diode is directly connected to a 24 GHz stub. This output is loaded by a 100 kΩ resistor and a 100 pF capacitor. The output voltage is fed to a 2-pin, 2.54 mm header.

The circuit was built on a 0.254 mm Rogers RO-4350B substrate and measured with a power-variable 24 GHz source. A layout design is illustrated in Figure 3.

Input power versus detected voltage for this detector is shown in Figure 8.

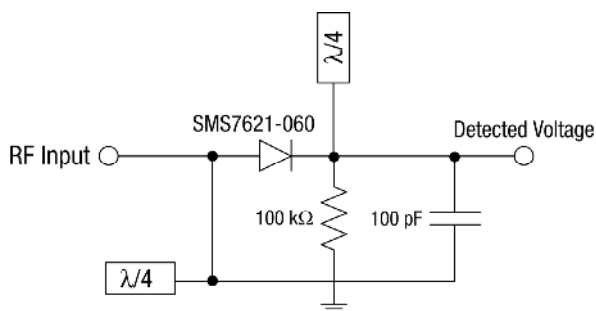

Figure 2. Schematic of a 24 GHz Detector Design

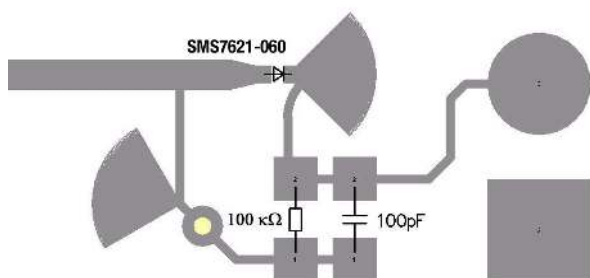

Figure 3. Layout for a 24 GHz Detector Design

### 24 GHz Rat-Race Mixer

A rat-race mixer that uses two SMS7621-060 Schottky diodes is shown in Figure 4. The LO signal (24 GHz) is fed from the right side and reaches a rat-race ring. The diodes are positioned 90 degrees apart from the LO input and are terminated in a stub.

Both diodes are connected (using a 1206 resistor) and are loaded by a 470 Ω resistor and a 10 pF capacitor. This forms the IF output (10 MHz). The RF input (24.010 GHz) is directly connected to the rat-race ring. A layout design is illustrated in Figure 5.

The mixer has been tested with the following conditions:

LO frequency: 24 GHz

LO power: 0 to +5 dBm

RF frequency: 24.010 GHz

RF power: -30 dBm

The IF output was loaded with 50 Ω. Measured conversion loss data for this mixer is shown in Figure 9.

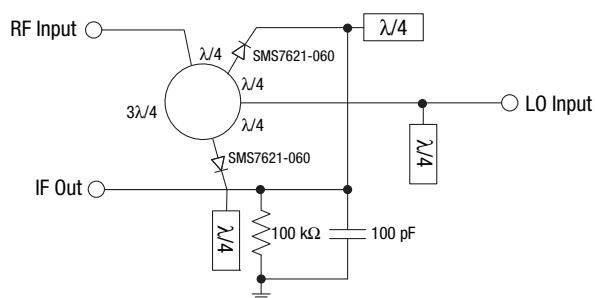

Figure 4. Schematic of a 24 GHz Rat-Race Mixer

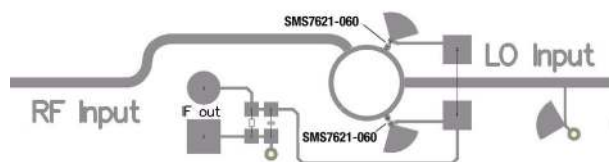

Figure 5. Layout for a 24 GHz Rat-Race Mixer

### Electrical and Mechanical Specifications

The absolute maximum ratings of the SMS7621-060 are provided in Table 1. Electrical specifications are provided in Table 2. The associated SPICE model parameters are provided in Table 3.

Typical performance characteristics are shown in Figures 6 through 9.

### Package Dimensions

The PCB layout footprint for the SMS7621-060 is provided in Figure 10. Package dimensions are shown in Figure 11, and tape and reel dimensions are provided in Figure 12.

### Package and Handling Information

Instructions on the shipping container label regarding exposure to moisture after the container seal is broken must be followed. Otherwise, problems related to moisture absorption may occur when the part is subjected to high temperature during solder assembly.

The SMS7621-060 is rated to Moisture Sensitivity Level 1 (MSL1) at 260 °C. It can be used for lead or lead-free soldering. For additional information, refer to the Skyworks Application Note, *Solder Reflow Information*, document number 200164.

Care must be taken when attaching this product, whether it is done manually or in a production solder reflow environment. Production quantities of this product are shipped in a standard tape and reel format.

**Table 1. SMS7621-060 Series Absolute Maximum Ratings (Note 1)**

Parameter	Symbol	Minimum	Maximum	Units
Reverse voltage	V <sub>R</sub>		2	V
Forward current	I <sub>F</sub>		50	mA
Power dissipation	P <sub>D</sub>		75	mW
Storage temperature	T <sub>STG</sub>	-65	+200	°C
Operating temperature	T <sub>A</sub>	-65	+150	°C
Electrostatic discharge:	ESD			
Charged Device Model (CDM), Class 4			1000	V
Human Body Model (HBM), Class 0			100	V
Machine Model (MM), Class A			30	V

<sup>1</sup> Exposure to maximum rating conditions for extended periods may reduce device reliability. There is no damage to device with only one parameter set at the limit and all other parameters set at or below their nominal value. Exceeding any of the limits listed here may result in permanent damage to the device.

**ESD HANDLING:** *Although this device is designed to be as robust as possible, electrostatic discharge (ESD) can damage this device. This device must be protected at all times from ESD when handling or transporting. Static charges may easily produce potentials of several kilovolts on the human body or equipment, which can discharge without detection. Industry-standard ESD handling precautions should be used at all times.*

**Table 2. SMS7621-060 Electrical Specifications<sup>1</sup>**  
**(T<sub>A</sub> = +25 °C, Unless Otherwise Noted)**

Minimum Breakdown Voltage @ I <sub>R</sub> = 10 μA (V)	Maximum Total Capacitance @ V <sub>R</sub> = 0 V, f = 1 MHz (pF)	Forward Voltage @ I <sub>F</sub> = 1 mA (mV)	Maximum Series Resistance (Ω)
2	0.18	260 to 320	12

<sup>1</sup> Performance is guaranteed only under the conditions listed in this table.

**Table 3. SPICE Model Parameters**

Parameter	Units	SMS7621-060
Is	A	2.6459E-8
Rs	$\Omega$	10.3
N	–	1.01
TT	sec	1E-11
CJo	pF	0.13
M	–	0.35
Eg	eV	0.69
XTI	–	2
Fc	–	0.5
Bv	V	3
Ibv	A	1E-5
Vj	V	0.51

**Typical Performance Characteristics @ 25 °C**

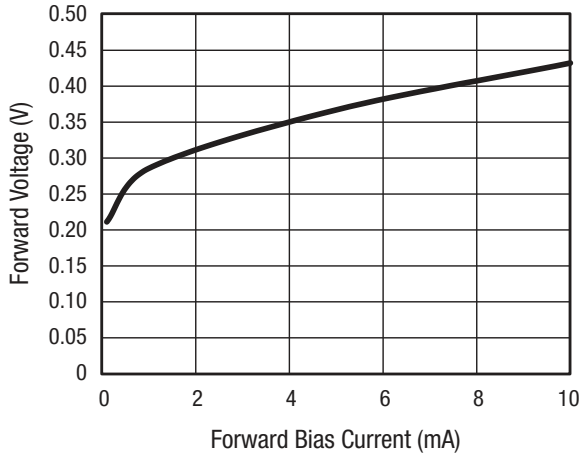

**Figure 6. Forward Voltage vs Forward Current**

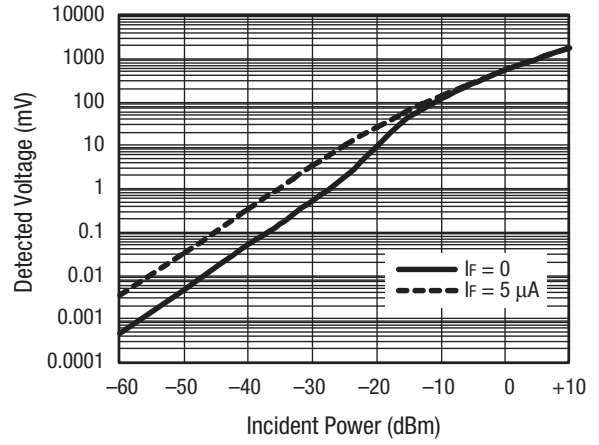

**Figure 7. Detector Voltage @ 2.45 GHz (100 kΩ Video Resistance)**

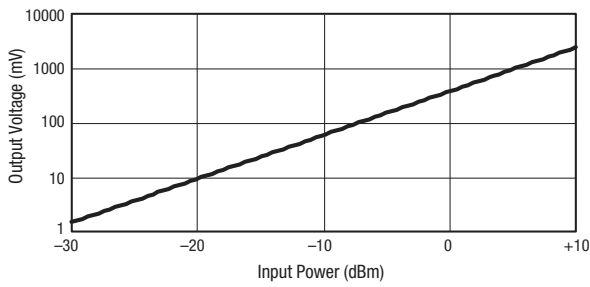

**Figure 8. Output Voltage vs Input Power**

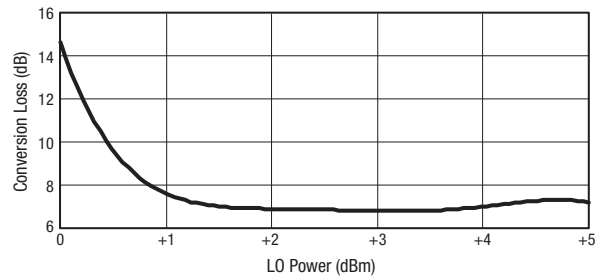

**Figure 9. Conversion Loss vs LO Power**

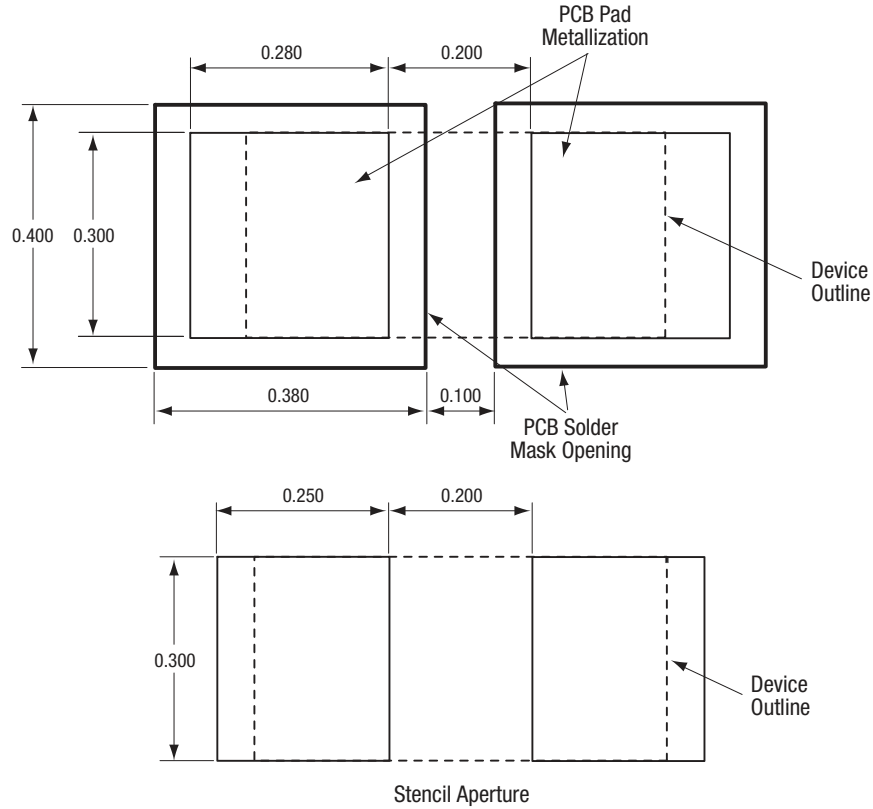

All measurements are in millimeters

S2030

Figure 10. SMS7621-060 PCB Layout Footprint

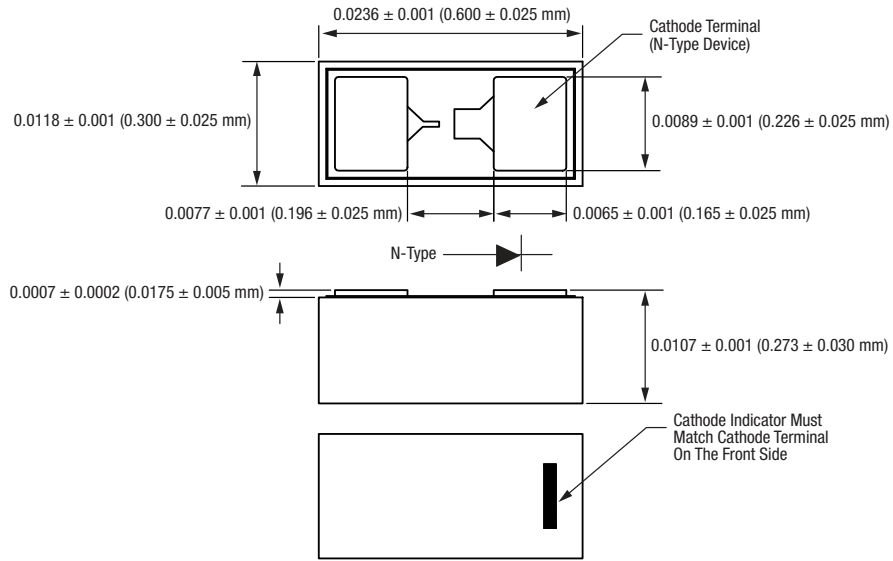

S1998

Figure 11. SMS7621-060 Package Dimension Drawing

