

Using the UCD3138CC64EVM-030

User's Guide



Literature Number: SLUU886A
February 2012–Revised July 2013

Control Card for Digitally Controlled Isolated Power Converters

1 Introduction

The UCD3138CC64EVM-030 evaluation module helps evaluate the UCD3138 device made by Texas Instruments and aids in the design of digitally controlled isolated power converters. The EVM can be used either as a stand-alone control card to study the UCD3138 controller device, or as a DPWM controller board working with a power-stage board to implement a fully regulated power converter. To help the targeted off-line isolated power applications, this EVM has been designed to work seamlessly with the UCD3138PFCEVM-026, UCD3138PSFBEVM-027, and UCD3138LLCEVM-028 power-converter EVMs offered by TI.

Alternately the EVM can also be loaded with custom user-developed firmware. In order to communicate with the UCD3138 digital controller in this EVM, a separate USB Interface Adapter EVM from TI known as the *USB-TO-GPIO Adapter* is required. The USB-TO-GPIO adapter is NOT supplied with UCD3138CC64EVM-030 evaluation module and must be purchased separately. TI also offers a Graphical User Interface (GUI) in order to program the UCD3138 controller and configure parameters when used with the power-converter EVMs mentioned above.

2 Description

The UCD3138CC64EVM-030 is an EVM board, functioning as a control card for UCD3138RGC digital power-supply applications. This EVM is used to control a power-converter topology such as PFC pre-regulator, LLC Resonant Half-Bridge DC converter, and Phase-Shifted Full-Bridge DC converter by downloading the associated firmware and interfacing with an appropriate power stage board. After the UCD3138 is programmed appropriately, the EVM works seamlessly with the following EVM boards from Texas Instruments. Please visit www.ti.com to check EVM status and availability.

- UCD3138PFCEVM-026, a digital controlled PFC pre-regulator evaluation board, Texas Instruments Literature Number, [SLUU885](#)
- UCD3138PSFBEVM-027, a digital controlled phase-shift full-bridge DC-to-DC converter evaluation board
- UCD3138LLCEVM-028, a digital controlled LLC resonant half-bridge DC-to-DC converter evaluation board, Texas Instruments Literature Number, [SLUU979](#)

2.1 Typical Applications

- Isolated Power Supply Applications (such as single-phase, two-phase interleaved or bridgeless PFC, LLC resonant half-bridge DC-to-DC power converter, phase-shifted full-bridge DC-to-DC power converter, and hard switching full-bridge DC-to-DC power converter)
- Server Power Supplies and Telecom Rectifiers
- Isolated DC-to-DC Telecom Modules

2.2 Features

- 40-Pin Digital Signal Connector to Connect Digital Signals to Power Converters
- 40-Pin Analog Signal Connector to Connect Analog Signals to Power Converters
- JTAG Connector
- LED Indicator
- PMBus Connector to PC Computer Connection Through USB-to-GPIO Adapter
- Rich Test Points to Facilitate the Device Evaluation, System Design, and Circuit and Firmware Debugging
- 12-V Input Capable With Onboard Regulator 3.3 V

3 Specifications

Table 1. UCD3138CC64EVM-030 Specifications

PARAMETER	TEST CONDITIONS	MIN	TYP	MAX	UNITS
Connector J1					
PMBus connector	Port of connection to USB-to-GPIO, pin definition refer to TI standard USB-to-GPIO document SLLU093	Standard			
Connector J2					
3.3-V connection to PMBus	Port to use on board 3.3 VD to bias PMBus ⁽¹⁾	3.25	3.30	3.35	VDC
Connector J3					
Analog signal connection	Pin definition in compliance with UCD3138	40-pin			
Connector J4					
Digital signal connection	Pin definition in compliance with UCD3138	40-pin			
Pin 39	External voltage source input	11.5	12.0	12.5	VDC
Connector J5					
JTAG	Standard JTAG communication connection	Standard			
Connector J6					
3.3-V on board to external use	Port to use 3.3 V on board to bias external circuit	3.27	3.30	3.32	VDC
Operation Environment					
Operating temperature range	Natural Convection	25			°C
MECHANICAL CHARACTERSTICS					
Dimensions	Width	1.8			inches
	Length	3.4			
	Component height	0.5			

⁽¹⁾ Apply jumper to provide a 3.3-V bias to board from USB-to-GPIO adapter.

4 Schematics and Test Points

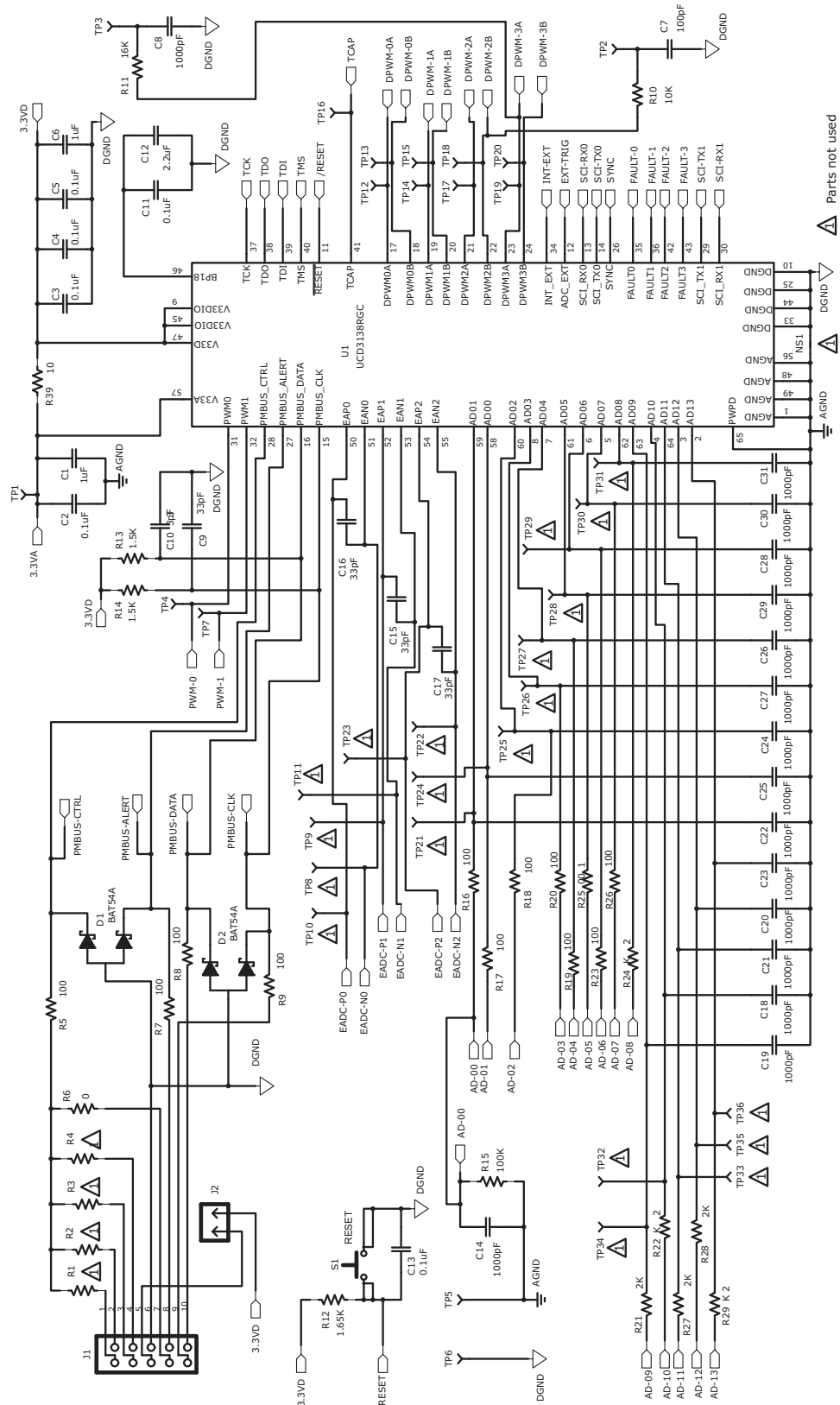

Figure 1. UCD3138CC64EVM-030 Schematic

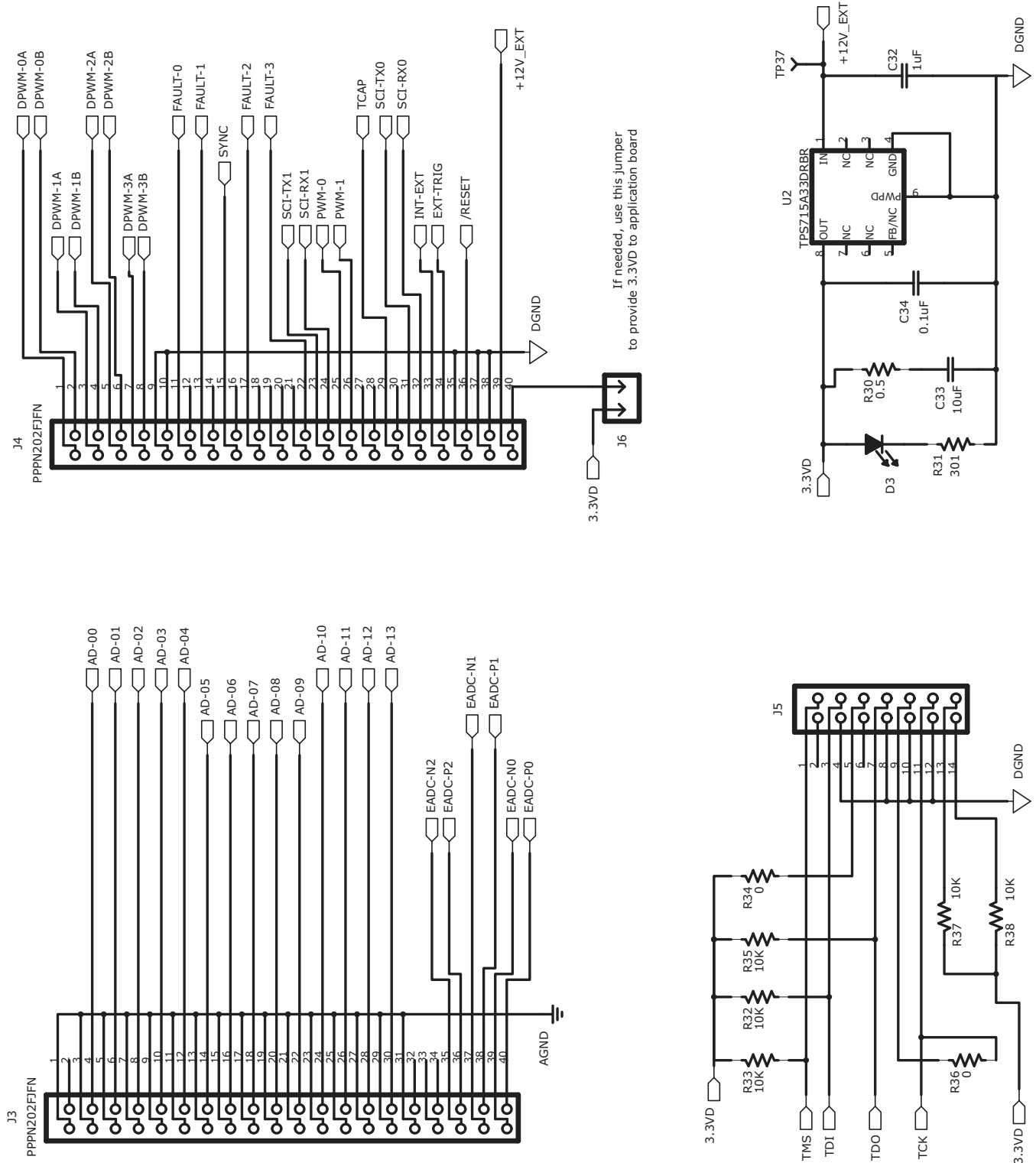

Figure 2. UCD3138CC64EVM-030 Schematic

4.1 List of Test Points

The functions of each test point for the UCD3138CC64EVM-030.

Table 2. Test Point Functions

TEST POINTS	NAME	DESCRIPTION
TP1	3.3VA	3.3-V analog on board
TP2	RC filter 2B	DPWM2B RC filter
TP3	RC filter 3A	DPWM3A RC filter
TP4	PWM-0	PWM0
TP5	AGND	Analog GND
TP6	DGND	Digital GND
TP7	PWM-1	PWM1
TP8	EADC-N0	EAN0
TP9	EADC-P1	EAP1
TP10	EADC-P0	EAP0
TP11	EADC-N1	EAN1
TP12	DPWM-0A	DPWM0A
TP13	DPWM-0B	DPWM0B
TP14	DPWM-1A	DPWM1A
TP15	DPWM-1B	DPWM1B
TP16	TCAP	TCAP
TP17	DPWM-2A	DPWM2A
TP18	DPWM-2B	DPWM2B
TP19	DPWM-3A	DPWM3A
TP20	DPWM-3B	DPWM3B
TP21	AD-00	A to D converter channel AD01
TP22	EADC-N2	EAN2
TP23	EADC-P2	EAP2
TP24	AD-01	A to D converter channel AD00
TP25 to 36	AD-02 to -13	A to D converter channels AD02 to AD13
TP37	+12V_EXT	External 12 V
J1	PMBus Connection	PMBus connector, 10 pins
J2	+3.3VD	Jumper header, if jump across, 3.3 V supplied from USB connection
J3	Analog Connection	40-pin header, analog signals
J4	Digital Connection	40-pin header, digital signals
J5	JTAG Connection	14-pin header, JTAG connector
J6	+3.3VD	Jumper header, if jump across, 3.3 V supplied to outside need
S1	Reset	UCD3138 reset, press to reset.

5 Test Equipment

5.1 PC Computer

5.1.1 Operating System

Microsoft Windows XP (32 bit), or Vista (32 bit), or Windows 7 (32 bit).

5.2 USB-to-GPIO Interface Adapter

This adapter (not included in this EVM, order separately) establishes the communication between the control card UCD3138CC64EVM-030 and the PC computer through the PMBus and the GUI, [Texas Instruments Fusion Digital Power Designer](#).

5.2.1 USB-to-GPIO Interface Adapter (HPA172)

Accessories included:

- USB Interface Adapter
- USB Cable, 5-pin B Mini Male to Type A Male
- Ribbon Cable, Socket-to-Socket, 10 Pin, 2 Headers, Polarized

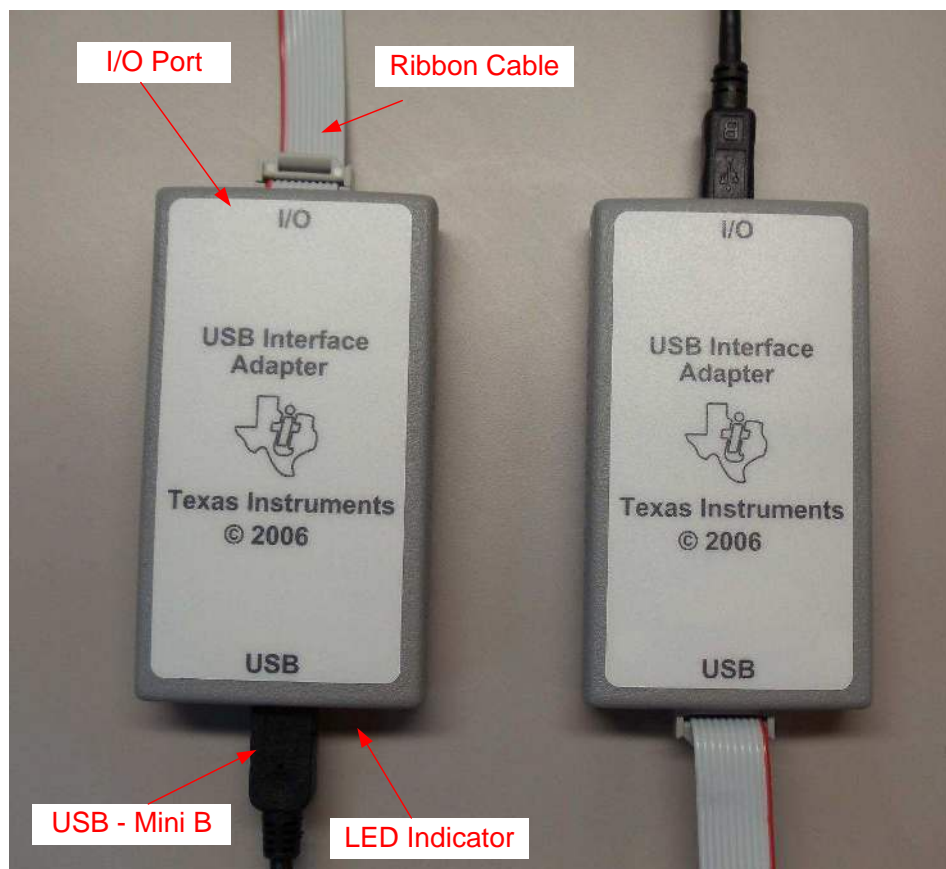

Figure 3. USB-to-GPIO Interface Adapter Outlook

5.3 Oscilloscope

An oscilloscope of analog or digital type is capable of 200-MHz bandwidth with Tektronix P6138 or equivalent oscilloscope probe.

6 Equipment Setup

6.1 GUI Setup

6.1.1 File for Installation

The GUI installation file is *TI-Fusion-Digital-Power-Designer-Version-1.8.92.exe* or newer version. To get the latest version of GUI, go to the Fusion Digital Power Designer tool folder ([Texas Instruments Fusion Digital Power Designer](#)) on the TI Web site, download, and install on computer.

6.1.2 Installation

Double click and launch the .exe file to start the installation. Click *Next* all the way through. When prompted, read through the agreement and click *I accept the agreement* when finished. Then click *install*. After the installation, click *Finish* to exit setup. Then click *Exit Program*.

6.1.3 Launch UCD3138 Device GUI

The GUI for UCD3138CC64EVM-030 board can be launched through the following steps:

1. Click the window *Start*
2. Click *All Programs*
3. Click *Texas Instruments Fusion Digital Power Designer*
4. Click *Device GUIs*
5. Click *UCD3xxx Device GUI*



Figure 4. Device GUI Launch Path

6.2 Hardware Setup

6.2.1 Setup Overview

The connection between UCD3138CC64EVM-030 and the PC computer through USB-to-GPIO Interface Adapter is shown in Figure 5.

For USB adapter connection, complete the following:

- Connect one end of the ribbon cable to the EVM, and connect the other end to the USB interface adapter.
- Connect the mini connector of the USB cable to the USB interface adapter, and connect the other end to the USB port of the PC computer.

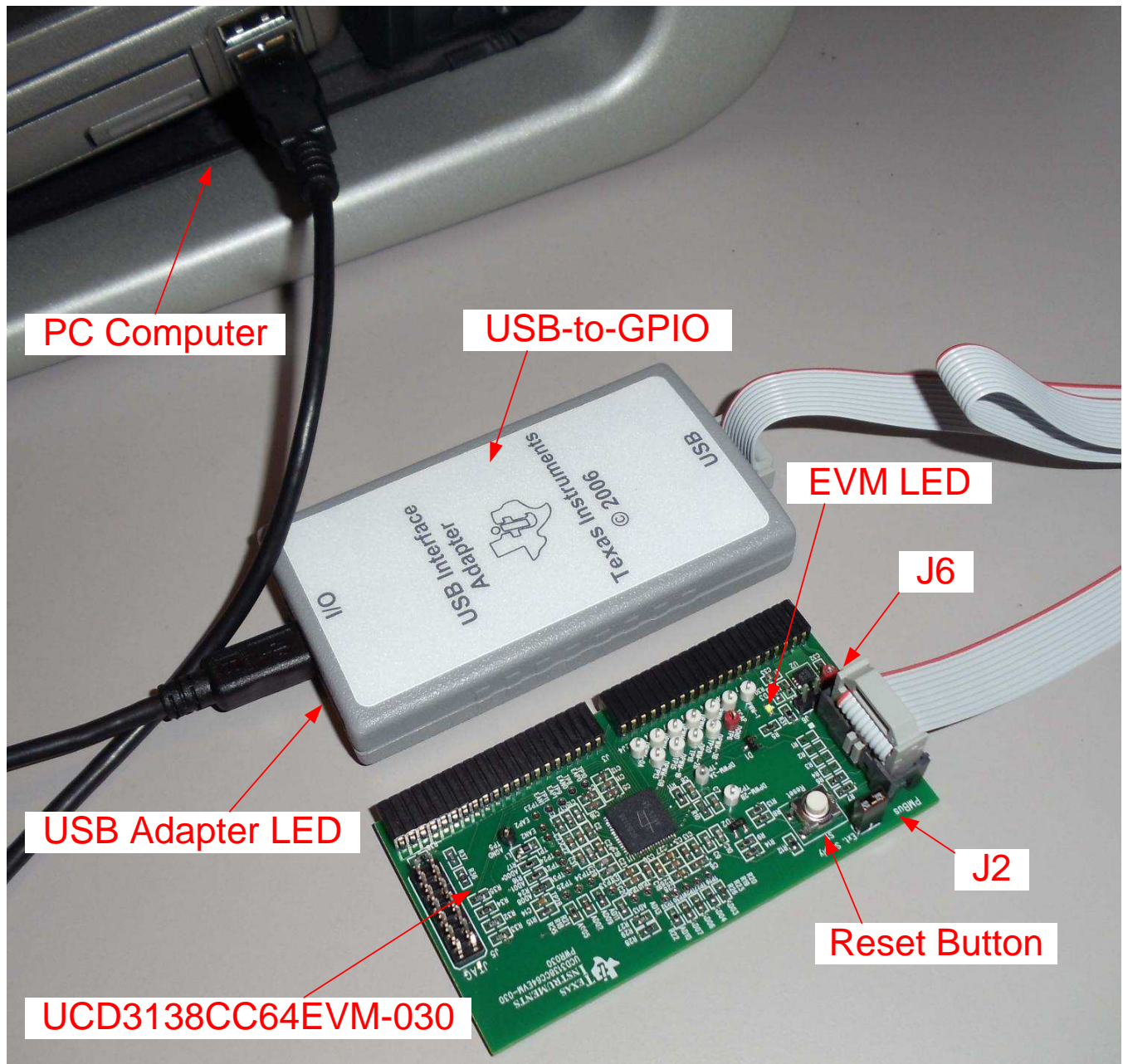

Figure 5. UCD3138CC64EVM-030 Test Connections

7 Test Procedure

7.1 Download Firmware Codes to UCD3138CC64EVM-030

See [Figure 5](#) to set up the EVM connection.

1. Set up the EVM connection based on [Figure 5](#). The LED of USB adapter lights up.
2. Use the provided jumper jump across J2. The LED of the EVM lights up.
3. Launch the UCD31xx device GUI following the steps described in [Section 6.1.3](#). The window shown in [Figure 6](#) appears.
4. Click *Firmware Download* and a new window appears as shown in [Figure 7](#). Click *Select File* and browse an intended firmware code file with file extension *.x0*, for example, *cyclone.x0*. Then click *Download*. TI recommends not writing the program *checksum* (stay in ROM) during firmware development or debug state. The firmware of *cyclone.x0* downloads to the device UCD3138 on the board of UCD3138CC64EVM-030. When asked, click *yes* to complete the download. Click *Close* to exit the download window.
5. After the firmware codes download to the UCD3138 device, the intended test can be performed. For example, with the provided firmware *cyclone.x0*, one can observe voltage toggled between 0 V and 3.3 V on test point TP7.

7.2 Erase Firmware Codes from UCD3138CC64EVM-030

Erasing the downloaded firmware codes from UCD3138 flash memory can be made with the steps below based on [Figure 6](#).

1. Click *Device ID*
2. Click *Command Program to jump to ROM (SendByte.0xD9)*
3. Click *Erase/Set PFlash: 0xFF*

7.3 Equipment Shutdown

1. Exit the GUI
2. Disconnect the USB cable and the ribbon cable

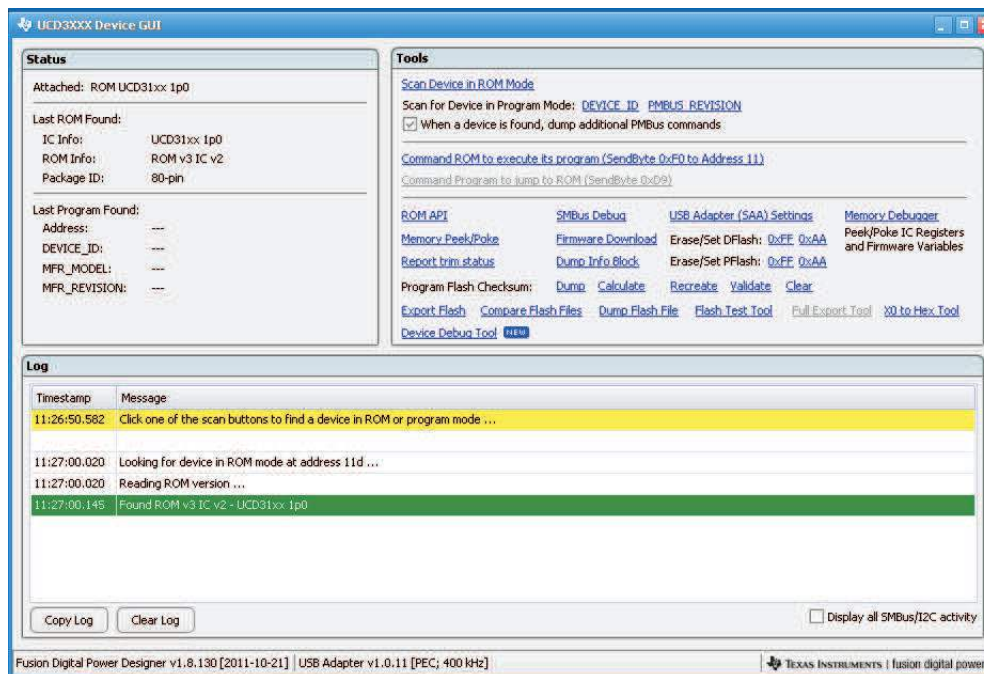

Figure 6. UCD31xx Device GUI

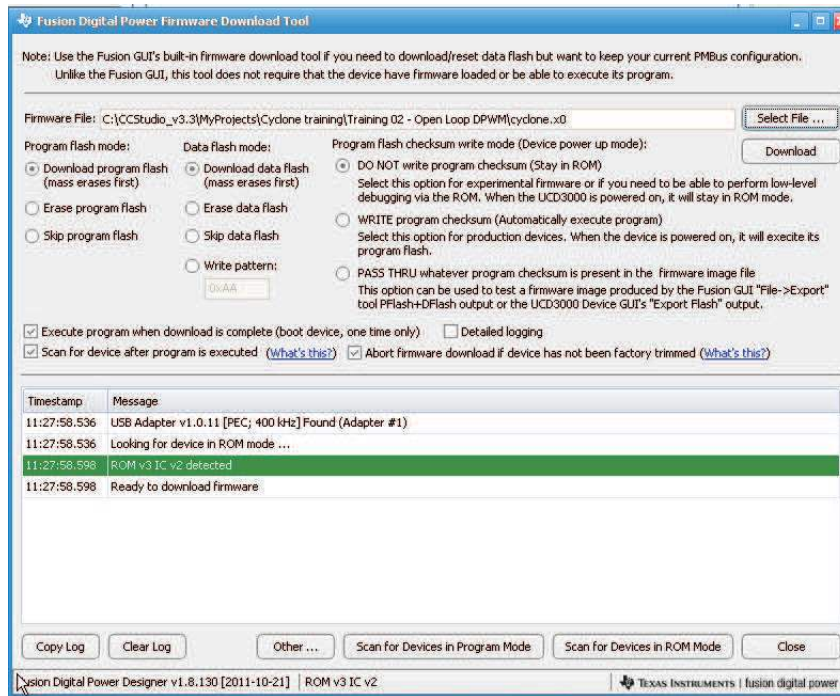

Figure 7. Firmware Code Downloading

8 EVM Assembly Drawing and PCB layout

The following figures (Figure 8 through Figure 13) show the design of the UCD3138CC64EVM-030 printed circuit board. PCB dimensions: L x W = 3.4 in x 1.8 in, PCB material: FR4 or compatible, four layers and 1-oz copper on each layer.

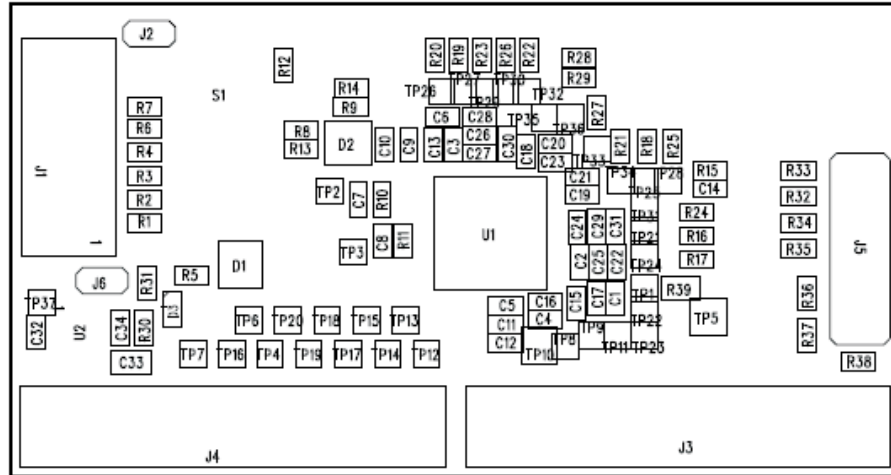

Figure 8. UCD3138CC64EVM-030 Top Layer Assembly Drawing (top view)

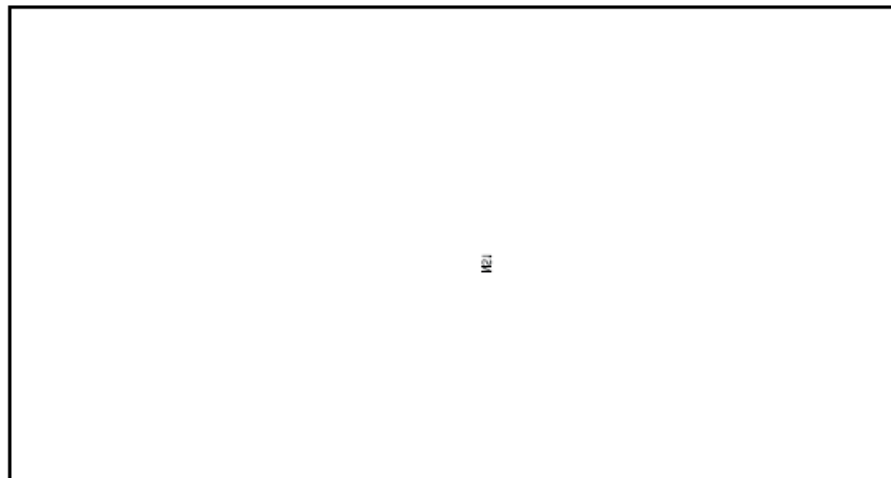

Figure 9. UCD3138CC64EVM-030 Bottom Assembly Drawing (no components on this side)

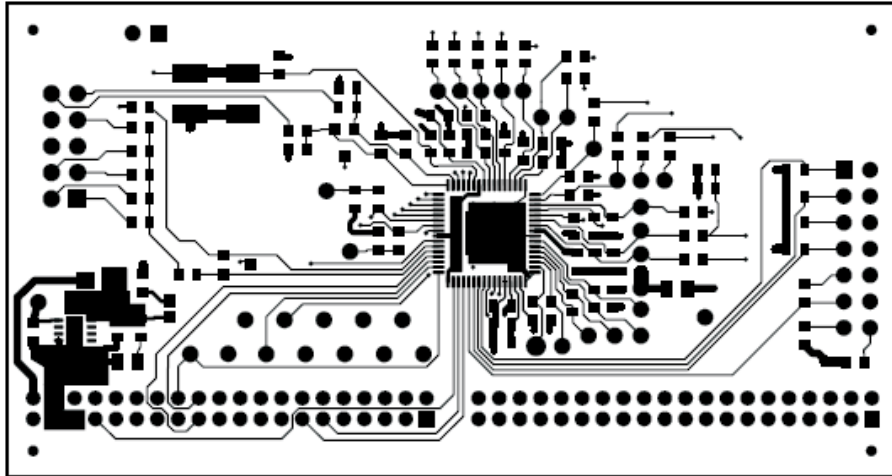

Figure 10. UCD3138CC64EVM-030 Top Copper (top view)

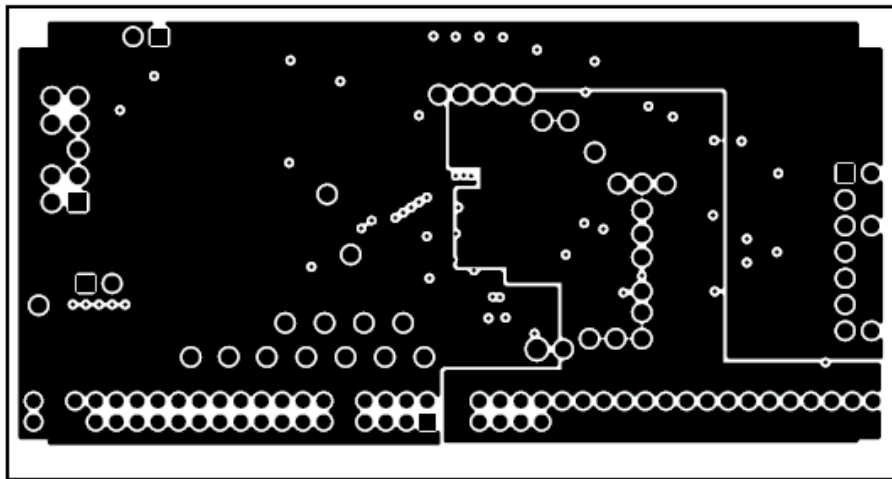

Figure 11. UCD3138CC64EVM-030 Internal Layer 1 (top view)

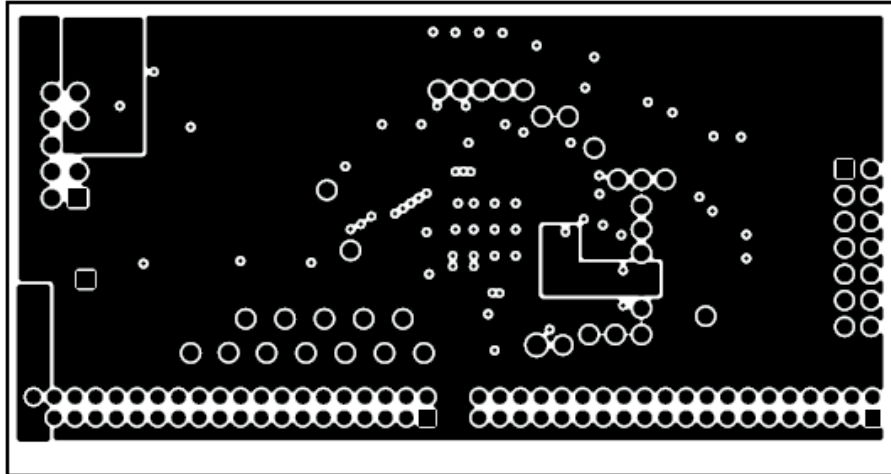

Figure 12. UCD3138CC64EVM-030 Internal Layer 2 (top view)

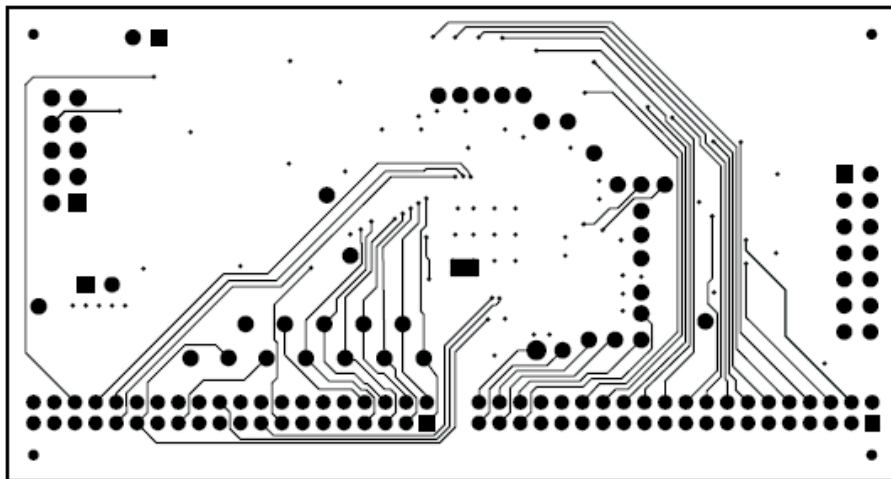

Figure 13. UCD3138CC64EVM-030 Bottom Copper (top view)

9 List of Materials

Table 3 lists the EVM components according to the schematic shown in Figure 1 and Figure 2.

Table 3. UCD3138CC64EVM-030 List of Materials

QTY	RefDes	Description	Part Number	MFR
3	C1, C6, C32	Capacitor, ceramic, 16 V, X7R, $\pm 10\%$, 1 μF , 0603	STD	STD
1	C12	Capacitor, ceramic, 16 V, X5R, $\pm 10\%$, 2.2 μF , 0603	STD	STD
7	C2, C3, C4, C5, C11, C13, C34	Capacitor, ceramic, 16 V, X7R, $\pm 10\%$, 0.1 μF , 0603	STD	STD
1	C33	Capacitor, ceramic, 10 V, X5R, $\pm 10\%$, 10 μF , 0805	STD	STD
1	C7	Capacitor, ceramic, 50 V, X7R, $\pm 10\%$, 100 pF, 0603	STD	STD
16	C8, C14, C18, C19, C20, C21, C22, C23, C24, C25, C26, C27, C28, C29, C30, C31	Capacitor, ceramic, 50 V, X7R, $\pm 10\%$, 1000 pF, 0603	STD	STD
5	C9, C10, C15, C16, C17	Capacitor, ceramic, 50 V, NP0, $\pm 10\%$, 33 pF, 0603	STD	STD
2	D1, D2	Diode, dual Schottky, common anode, 300 mA, 30 V, SOT23	BAT54AFILM	ST
1	D3	Diode, LED, green, 2.1 V, 20 mA, 6 mcd, 0603	LTST-C190GKT	Lite On
1	J1	Header, 2 x 5 pin, 100-mil spacing	5103308-1	Tyco
2	J2, J6	Header, male 2 pin, 100-mil spacing	PEC02SAAN	Sullins
2	J3, J4	Conn header 2-mm dual R/A 40POS	PPPN202FJFN-RC	Sullins
1	J5	Header, male 2 x 7 pin, 100-mil spacing	PEC07DAAN	Sullins
0	R1, R2, R3, R4	Resistor, chip, 1/16 W, 1%, open, 0603	STD	STD
6	R10, R32, R33, R35, R37, R38	Resistor, chip, 1/16 W, 1%, 10 k Ω , 0603	STD	STD
1	R11	Resistor, chip, 1/16 W, 1%, 16 k Ω , 0603	STD	STD
1	R12	Resistor, chip, 1/16 W, 1%, 1.65 k Ω , 0603	STD	STD
2	R13, R14	Resistor, chip, 1/16 W, 1%, 1.5 k Ω , 0603	STD	STD
1	R15	Resistor, chip, 1/16 W, 1%, 100 k Ω , 0603	STD	STD
6	R21, R22, R24, R27, R28, R29	Resistor, chip, 1/16 W, 1%, 2 k Ω , 0603	STD	STD
1	R30	Resistor, chip, 1/16 W, 1%, 0.5 Ω , 0603	STD	STD
1	R31	Resistor, chip, 1/16 W, 1%, 301 Ω , 0603	STD	STD
1	R39	Resistor, chip, 1/10 W, 1%, 10 Ω , 0805	Std	Std
12	R5, R7, R8, R9, R16, R17, R18, R19, R20, R23, R25, R26	Resistor, chip, 1/16 W, 1%, 100 Ω , 0603	STD	STD
3	R6, R34, R36	Resistor, chip, 1/16 W, 1%, 0 Ω , 0603	STD	STD
1	S1	Switch, SPST, PB momentary, sealed washable, 0.245 x 0.251	KT11P2JM-34LFS	C & K
1	U1	Digital Power Controller, PFC-64	UCD3138RGC	TI
1	U2	High Input Voltage, Micro power, 3.2 μA at 80 mA LDO, 3.3 V, QFN-8	TPS715A33DRBR	TI

Appendix A Summary of Using Code Composer Studio v3.3

This appendix describes the basic steps on how to use Code Composer Studio v3.3, or CCS, to compile firmware for UCD3138. The design flow describes detailed steps for firmware code creation and firmware debugging.

A.1 Set Up Code Composer Studio v3.3 for UCD3138

The recommended version of Code Composer Studio is version 3.3 (v3.3). After completing the CCS v3.3 installation, and when CCS is opened for the first time, the window shown in [Figure 14](#) prompts users to select the required configuration. For UCD3138 device, please select *ARM7 SIMULATOR BIG ENDIAN*. Click *ADD* and then *Save & Quit*.

If CCS has existing configurations in *My System*, click *Launch Setup* under *File* pull-down menu. Select *Remove All* to remove the existing configurations; then select *ARM7 SIMULATOR BIG ENDIAN* as shown in [Figure 14](#), Click *ADD* and then *Save & Quit* for UCD3138 device.

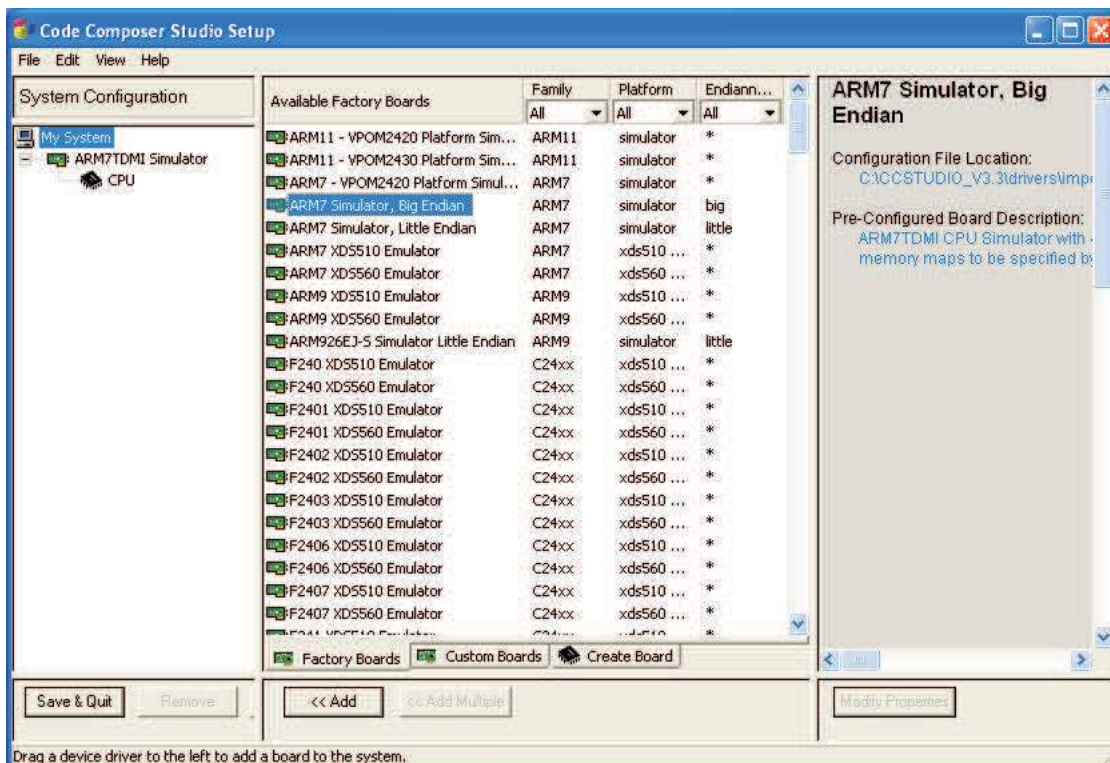

Figure 14. Set Up Code Composer Studio v3.3 for UCD3138

A.2 Build and Compile a Project Using Code Composer Studio

After a project is created with all source codes developed, one can compile the project using CCS.

A.2.1 Creating a Project

The example below describes the typical compile process for UCD3138 firmware. The project file name is *Cyclone.pjt* and it is located in the folder named *Training 02*. The final result of the compile process is a file with the file extension of *.x0*. Because the project name is *Cyclone.pjt*, the final file name of *Cyclone.x0* is naturally chosen. *Cyclone.x0* is the final firmware code downloaded to the UCD3138 device memory for the UCD3138 intended functional operation. The following are the steps for a typical compile process:

1. Copy file folder *Training 02* and paste into any desired directory inside the PC.
2. Launch CCS and open the CCS project file *Cyclone.pjt* from the directory where *Training 02* was saved. The window shown in [Figure 15](#) appears.
 - Note, because the project *Cyclone.pjt* has been created and designed for UCD3138 functions, CCS can be launched without connecting an emulator.
3. From CCS project window, Right click on *Cyclone.pjt (Debug)* and then select *Build Options*. The window shown in [Figure 16](#) appears when the *Linker* tab is selected.
 - [Figure 16](#) shows the project *Build Options* have been selected to create the file *Cyclone.out* from CCS.
4. Convert the file *Cyclone.out* to *Cyclone.x0*. *Cyclone.x0* is the final firmware code downloaded to the UCD3138 device memories. To convert *Cyclone.out* to *Cyclone.x0*, first click the *General* tab under *Build Options for Cyclone.pjt (Debug)*, as shown in [Figure 17](#). Second, under the *Build Command*, confirm that the file to be converted is *Cyclone.out*. Third, click *ok* to close *Build Options*.

Steps 4, 5, and 6 are only necessary once per project. If using a platform with TI developed firmware, these steps have been set up and there is no need to repeat.
5. Select *Project Rebuild All*, as shown in [Figure 18](#). *Project Rebuild All* generates the file *Cyclone.x0* based on *Cyclone.out*, and saves the file of *Cyclone.x0* inside the folder where *Cyclone.pjt* is saved.

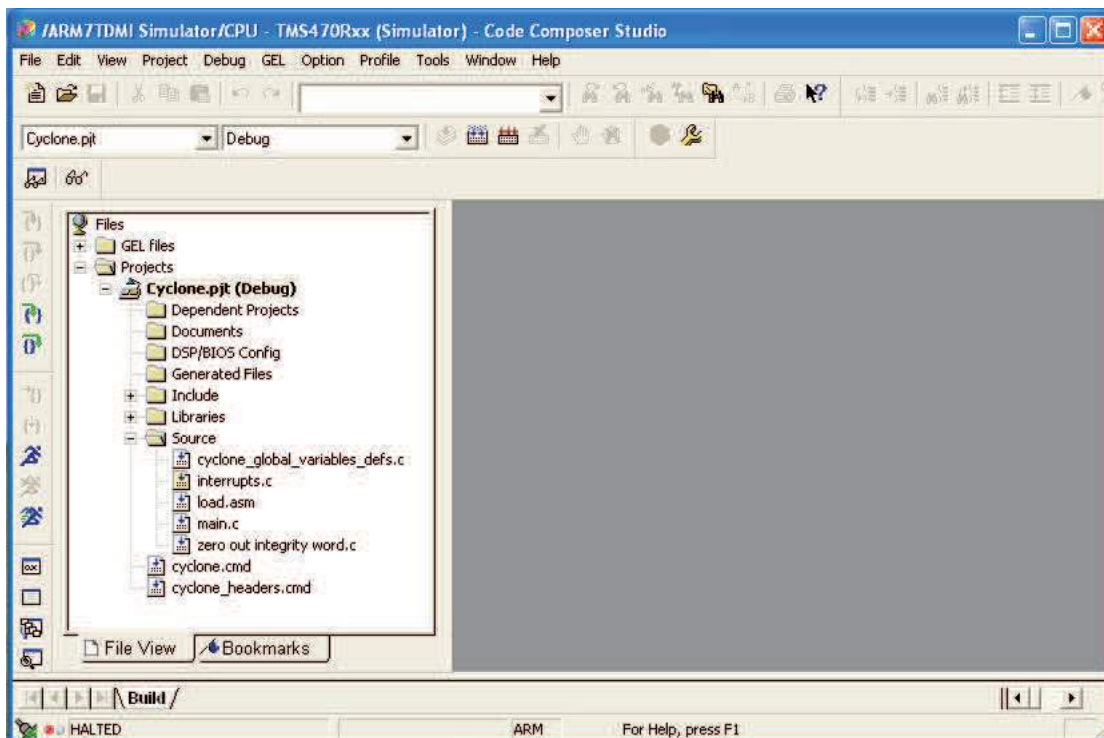

Figure 15. Open a Project File with Example of *Cyclone.pjt* – Initial Open.

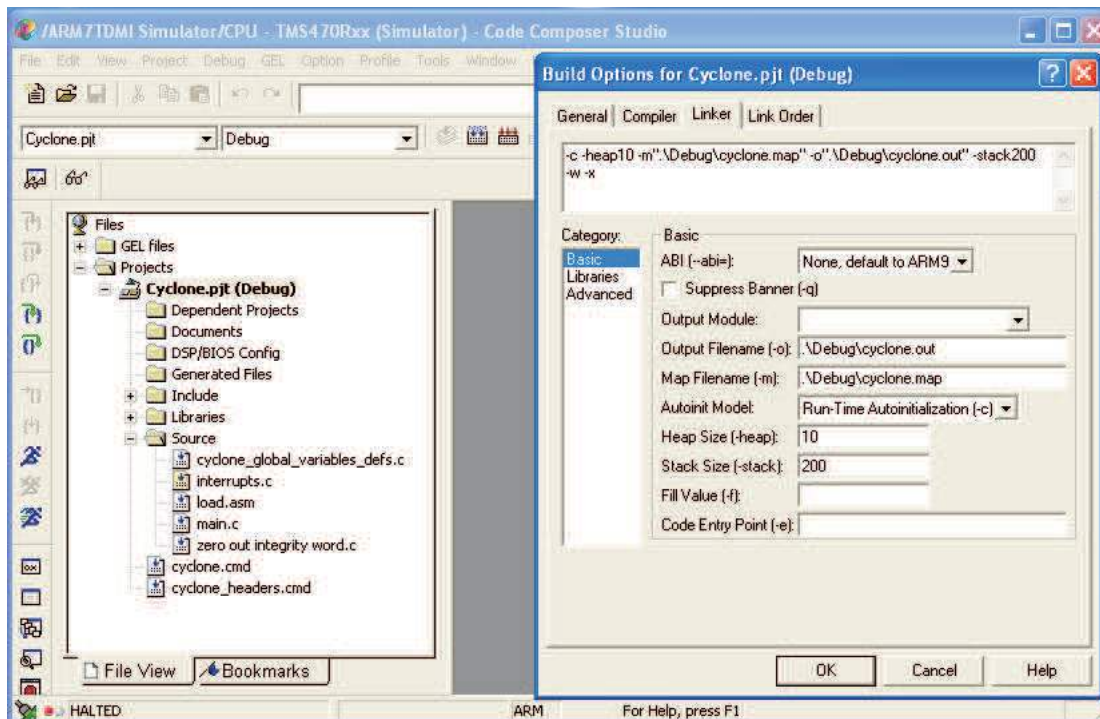

Figure 16. Open a Project File with Example of Cyclone.pjt – Build Options and Linker Tab

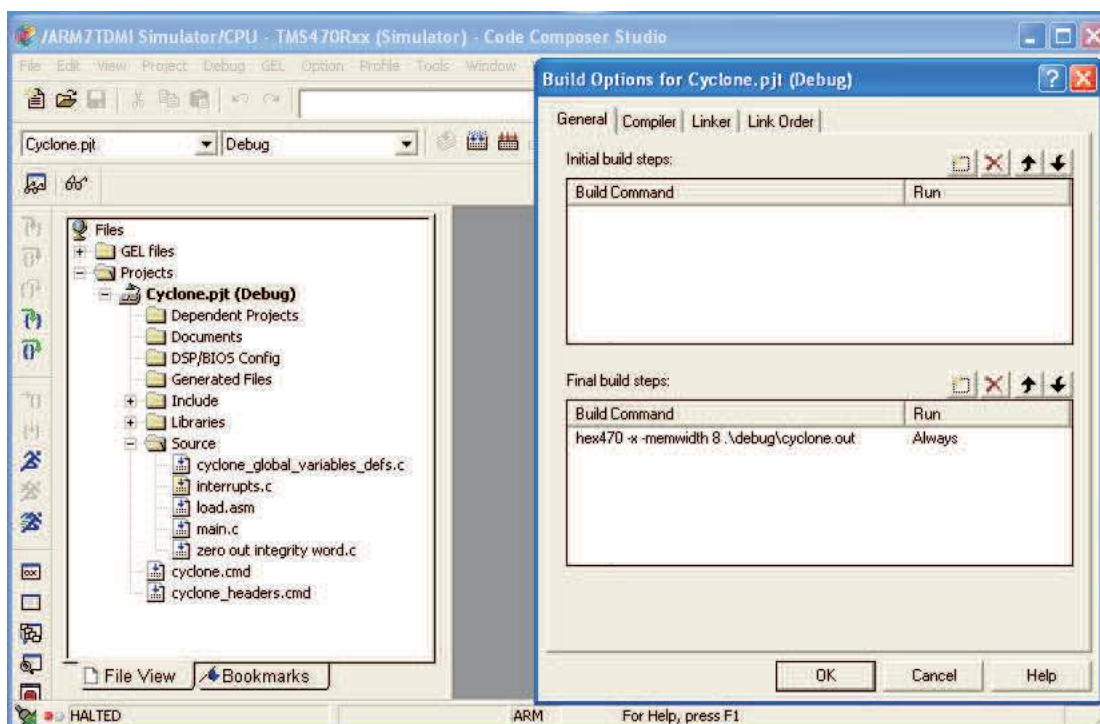

Figure 17. Open a Project File With Example of Cyclone.pjt - Build Options and General Tab

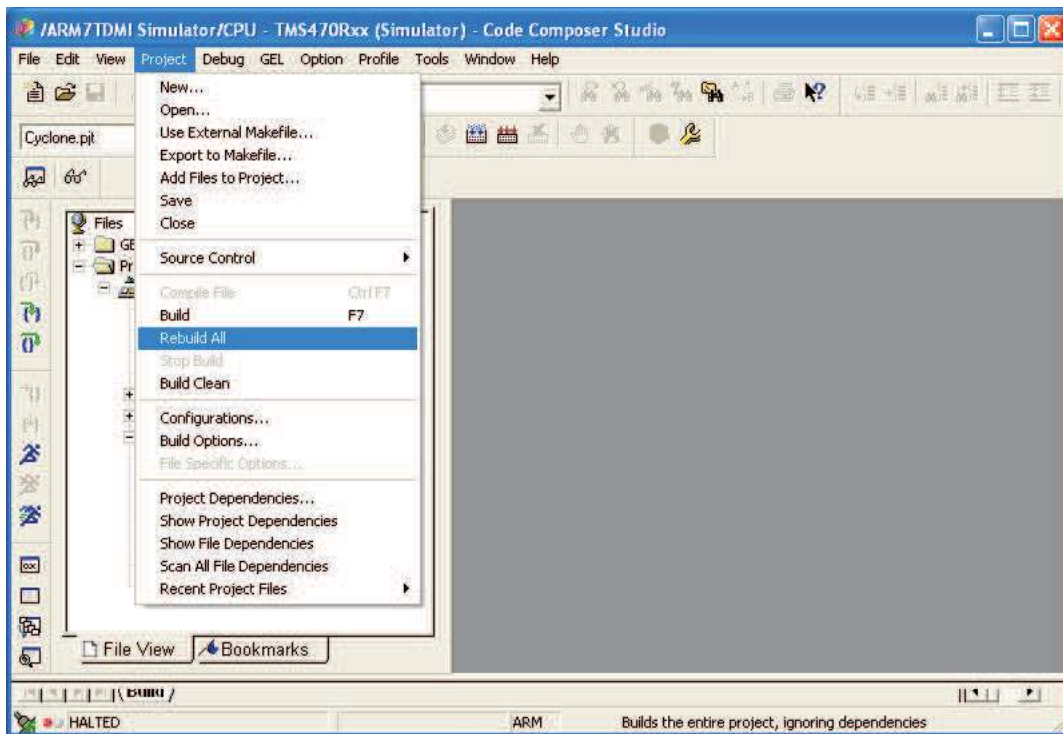

Figure 18. Opened Project File With Example of *Cyclone.pjt* - Rebuild All

A.3 References

1. UCD3138 Datasheet, *Highly Integrated Digital Controller for Isolated Power*, Texas Instruments Literature Number, [SLUSAP2](#)
2. *Code Composer Studio Development Tools v3.3 – Getting Started Guide*, Texas Instruments Literature Number, [SPRU509](#)
3. Reference Guide, *UCD3138 Digital Power Peripherals Programmer's Manual*, Texas Instruments Literature Number, [SLUU995](#)
4. Reference Guide, *UCD3138 Monitoring and Communications Programmer's Manual*, Texas Instruments Literature Number, [SLUU996](#)
5. Reference Guide, *UCD3138 ARM and Digital System Programmer's Manual*, Texas Instruments Literature Number, [SLUU994](#)
6. User's Guide, *UCD3138 Isolated Power Fusion GUI*, (please contact TI).

EVALUATION BOARD/KIT/MODULE (EVM) ADDITIONAL TERMS

Texas Instruments (TI) provides the enclosed Evaluation Board/Kit/Module (EVM) under the following conditions:

The user assumes all responsibility and liability for proper and safe handling of the goods. Further, the user indemnifies TI from all claims arising from the handling or use of the goods.

Should this evaluation board/kit not meet the specifications indicated in the User's Guide, the board/kit may be returned within 30 days from the date of delivery for a full refund. THE FOREGOING LIMITED WARRANTY IS THE EXCLUSIVE WARRANTY MADE BY SELLER TO BUYER AND IS IN LIEU OF ALL OTHER WARRANTIES, EXPRESSED, IMPLIED, OR STATUTORY, INCLUDING ANY WARRANTY OF MERCHANTABILITY OR FITNESS FOR ANY PARTICULAR PURPOSE. EXCEPT TO THE EXTENT OF THE INDEMNITY SET FORTH ABOVE, NEITHER PARTY SHALL BE LIABLE TO THE OTHER FOR ANY INDIRECT, SPECIAL, INCIDENTAL, OR CONSEQUENTIAL DAMAGES.

Please read the User's Guide and, specifically, the Warnings and Restrictions notice in the User's Guide prior to handling the product. This notice contains important safety information about temperatures and voltages. For additional information on TI's environmental and/or safety programs, please visit www.ti.com/esh or contact TI.

No license is granted under any patent right or other intellectual property right of TI covering or relating to any machine, process, or combination in which such TI products or services might be or are used. TI currently deals with a variety of customers for products, and therefore our arrangement with the user is not exclusive. TI assumes no liability for applications assistance, customer product design, software performance, or infringement of patents or services described herein.

REGULATORY COMPLIANCE INFORMATION

As noted in the EVM User's Guide and/or EVM itself, this EVM and/or accompanying hardware may or may not be subject to the Federal Communications Commission (FCC) and Industry Canada (IC) rules.

For EVMs **not** subject to the above rules, this evaluation board/kit/module is intended for use for ENGINEERING DEVELOPMENT, DEMONSTRATION OR EVALUATION PURPOSES ONLY and is not considered by TI to be a finished end product fit for general consumer use. It generates, uses, and can radiate radio frequency energy and has not been tested for compliance with the limits of computing devices pursuant to part 15 of FCC or ICES-003 rules, which are designed to provide reasonable protection against radio frequency interference. Operation of the equipment may cause interference with radio communications, in which case the user at his own expense will be required to take whatever measures may be required to correct this interference.

General Statement for EVMs including a radio

User Power/Frequency Use Obligations: This radio is intended for development/professional use only in legally allocated frequency and power limits. Any use of radio frequencies and/or power availability of this EVM and its development application(s) must comply with local laws governing radio spectrum allocation and power limits for this evaluation module. It is the user's sole responsibility to only operate this radio in legally acceptable frequency space and within legally mandated power limitations. Any exceptions to this are strictly prohibited and unauthorized by Texas Instruments unless user has obtained appropriate experimental/development licenses from local regulatory authorities, which is responsibility of user including its acceptable authorization.

For EVMs annotated as FCC – FEDERAL COMMUNICATIONS COMMISSION Part 15 Compliant

Caution

This device complies with part 15 of the FCC Rules. Operation is subject to the following two conditions: (1) This device may not cause harmful interference, and (2) this device must accept any interference received, including interference that may cause undesired operation.

Changes or modifications not expressly approved by the party responsible for compliance could void the user's authority to operate the equipment.

FCC Interference Statement for Class A EVM devices

This equipment has been tested and found to comply with the limits for a Class A digital device, pursuant to part 15 of the FCC Rules. These limits are designed to provide reasonable protection against harmful interference when the equipment is operated in a commercial environment. This equipment generates, uses, and can radiate radio frequency energy and, if not installed and used in accordance with the instruction manual, may cause harmful interference to radio communications. Operation of this equipment in a residential area is likely to cause harmful interference in which case the user will be required to correct the interference at his own expense.

FCC Interference Statement for Class B EVM devices

This equipment has been tested and found to comply with the limits for a Class B digital device, pursuant to part 15 of the FCC Rules. These limits are designed to provide reasonable protection against harmful interference in a residential installation. This equipment generates, uses and can radiate radio frequency energy and, if not installed and used in accordance with the instructions, may cause harmful interference to radio communications. However, there is no guarantee that interference will not occur in a particular installation. If this equipment does cause harmful interference to radio or television reception, which can be determined by turning the equipment off and on, the user is encouraged to try to correct the interference by one or more of the following measures:

- Reorient or relocate the receiving antenna.
- Increase the separation between the equipment and receiver.
- Connect the equipment into an outlet on a circuit different from that to which the receiver is connected.
- Consult the dealer or an experienced radio/TV technician for help.

For EVMs annotated as IC – INDUSTRY CANADA Compliant

This Class A or B digital apparatus complies with Canadian ICES-003.

Changes or modifications not expressly approved by the party responsible for compliance could void the user's authority to operate the equipment.

Concerning EVMs including radio transmitters

This device complies with Industry Canada licence-exempt RSS standard(s). Operation is subject to the following two conditions: (1) this device may not cause interference, and (2) this device must accept any interference, including interference that may cause undesired operation of the device.

Concerning EVMs including detachable antennas

Under Industry Canada regulations, this radio transmitter may only operate using an antenna of a type and maximum (or lesser) gain approved for the transmitter by Industry Canada. To reduce potential radio interference to other users, the antenna type and its gain should be so chosen that the equivalent isotropically radiated power (e.i.r.p.) is not more than that necessary for successful communication.

This radio transmitter has been approved by Industry Canada to operate with the antenna types listed in the user guide with the maximum permissible gain and required antenna impedance for each antenna type indicated. Antenna types not included in this list, having a gain greater than the maximum gain indicated for that type, are strictly prohibited for use with this device.

Cet appareil numérique de la classe A ou B est conforme à la norme NMB-003 du Canada.

Les changements ou les modifications pas expressément approuvés par la partie responsable de la conformité ont pu vider l'autorité de l'utilisateur pour actionner l'équipement.

Concernant les EVMs avec appareils radio

Le présent appareil est conforme aux CNR d'Industrie Canada applicables aux appareils radio exempts de licence. L'exploitation est autorisée aux deux conditions suivantes : (1) l'appareil ne doit pas produire de brouillage, et (2) l'utilisateur de l'appareil doit accepter tout brouillage radioélectrique subi, même si le brouillage est susceptible d'en compromettre le fonctionnement.

Concernant les EVMs avec antennes détachables

Conformément à la réglementation d'Industrie Canada, le présent émetteur radio peut fonctionner avec une antenne d'un type et d'un gain maximal (ou inférieur) approuvé pour l'émetteur par Industrie Canada. Dans le but de réduire les risques de brouillage radioélectrique à l'intention des autres utilisateurs, il faut choisir le type d'antenne et son gain de sorte que la puissance isotrope rayonnée équivalente (p.i.r.e.) ne dépasse pas l'intensité nécessaire à l'établissement d'une communication satisfaisante.

Le présent émetteur radio a été approuvé par Industrie Canada pour fonctionner avec les types d'antenne énumérés dans le manuel d'usage et ayant un gain admissible maximal et l'impédance requise pour chaque type d'antenne. Les types d'antenne non inclus dans cette liste, ou dont le gain est supérieur au gain maximal indiqué, sont strictement interdits pour l'exploitation de l'émetteur.

【Important Notice for Users of EVMs for RF Products in Japan】

This development kit is NOT certified as Confirming to Technical Regulations of Radio Law of Japan

If you use this product in Japan, you are required by Radio Law of Japan to follow the instructions below with respect to this product:

1. Use this product in a shielded room or any other test facility as defined in the notification #173 issued by Ministry of Internal Affairs and Communications on March 28, 2006, based on Sub-section 1.1 of Article 6 of the Ministry's Rule for Enforcement of Radio Law of Japan,
2. Use this product only after you obtained the license of Test Radio Station as provided in Radio Law of Japan with respect to this product, or
3. Use of this product only after you obtained the Technical Regulations Conformity Certification as provided in Radio Law of Japan with respect to this product. Also, please do not transfer this product, unless you give the same notice above to the transferee. Please note that if you could not follow the instructions above, you will be subject to penalties of Radio Law of Japan.

Texas Instruments Japan Limited
(address) 24-1, Nishi-Shinjuku 6 chome, Shinjuku-ku, Tokyo, Japan

<http://www.tij.co.jp>

【無線電波を送信する製品の開発キットをお使いになる際の注意事項】

本開発キットは技術基準適合証明を受けておりません。

本製品のご使用に際しては、電波法遵守のため、以下のいずれかの措置を取っていただく必要がありますのでご注意ください。

1. 電波法施行規則第6条第1項第1号に基づく平成18年3月28日総務省告示第173号で定められた電波暗室等の試験設備でご使用いただく。
2. 実験局の免許を取得後ご使用いただく。
3. 技術基準適合証明を取得後ご使用いただく。

なお、本製品は、上記の「ご使用にあたっての注意」を譲渡先、移転先に通知しない限り、譲渡、移転できないものとします。

上記を遵守頂けない場合は、電波法の罰則が適用される可能性があることをご留意ください。

日本テキサス・インスツルメンツ株式会社
東京都新宿区西新宿 6 丁目 2 4 番 1 号
西新宿三井ビル

<http://www.tij.co.jp>

EVALUATION BOARD/KIT/MODULE (EVM) WARNINGS, RESTRICTIONS AND DISCLAIMERS

For Feasibility Evaluation Only, in Laboratory/Development Environments. Unless otherwise indicated, this EVM is not a finished electrical equipment and not intended for consumer use. It is intended solely for use for preliminary feasibility evaluation in laboratory/development environments by technically qualified electronics experts who are familiar with the dangers and application risks associated with handling electrical mechanical components, systems and subsystems. It should not be used as all or part of a finished end product.

Your Sole Responsibility and Risk. You acknowledge, represent and agree that:

1. You have unique knowledge concerning Federal, State and local regulatory requirements (including but not limited to Food and Drug Administration regulations, if applicable) which relate to your products and which relate to your use (and/or that of your employees, affiliates, contractors or designees) of the EVM for evaluation, testing and other purposes.
2. You have full and exclusive responsibility to assure the safety and compliance of your products with all such laws and other applicable regulatory requirements, and also to assure the safety of any activities to be conducted by you and/or your employees, affiliates, contractors or designees, using the EVM. Further, you are responsible to assure that any interfaces (electronic and/or mechanical) between the EVM and any human body are designed with suitable isolation and means to safely limit accessible leakage currents to minimize the risk of electrical shock hazard.
3. Since the EVM is not a completed product, it may not meet all applicable regulatory and safety compliance standards (such as UL, CSA, VDE, CE, RoHS and WEEE) which may normally be associated with similar items. You assume full responsibility to determine and/or assure compliance with any such standards and related certifications as may be applicable. You will employ reasonable safeguards to ensure that your use of the EVM will not result in any property damage, injury or death, even if the EVM should fail to perform as described or expected.
4. You will take care of proper disposal and recycling of the EVM's electronic components and packing materials.

Certain Instructions. It is important to operate this EVM within TI's recommended specifications and environmental considerations per the user guidelines. Exceeding the specified EVM ratings (including but not limited to input and output voltage, current, power, and environmental ranges) may cause property damage, personal injury or death. If there are questions concerning these ratings please contact a TI field representative prior to connecting interface electronics including input power and intended loads. Any loads applied outside of the specified output range may result in unintended and/or inaccurate operation and/or possible permanent damage to the EVM and/or interface electronics. Please consult the EVM User's Guide prior to connecting any load to the EVM output. If there is uncertainty as to the load specification, please contact a TI field representative. During normal operation, some circuit components may have case temperatures greater than 60°C as long as the input and output are maintained at a normal ambient operating temperature. These components include but are not limited to linear regulators, switching transistors, pass transistors, and current sense resistors which can be identified using the EVM schematic located in the EVM User's Guide. When placing measurement probes near these devices during normal operation, please be aware that these devices may be very warm to the touch. As with all electronic evaluation tools, only qualified personnel knowledgeable in electronic measurement and diagnostics normally found in development environments should use these EVMs.

Agreement to Defend, Indemnify and Hold Harmless. You agree to defend, indemnify and hold TI, its licensors and their representatives harmless from and against any and all claims, damages, losses, expenses, costs and liabilities (collectively, "Claims") arising out of or in connection with any use of the EVM that is not in accordance with the terms of the agreement. This obligation shall apply whether Claims arise under law of tort or contract or any other legal theory, and even if the EVM fails to perform as described or expected.

Safety-Critical or Life-Critical Applications. If you intend to evaluate the components for possible use in safety critical applications (such as life support) where a failure of the TI product would reasonably be expected to cause severe personal injury or death, such as devices which are classified as FDA Class III or similar classification, then you must specifically notify TI of such intent and enter into a separate Assurance and Indemnity Agreement.

Mailing Address: Texas Instruments, Post Office Box 655303, Dallas, Texas 75265
Copyright © 2013, Texas Instruments Incorporated

IMPORTANT NOTICE

Texas Instruments Incorporated and its subsidiaries (TI) reserve the right to make corrections, enhancements, improvements and other changes to its semiconductor products and services per JESD46, latest issue, and to discontinue any product or service per JESD48, latest issue. Buyers should obtain the latest relevant information before placing orders and should verify that such information is current and complete. All semiconductor products (also referred to herein as "components") are sold subject to TI's terms and conditions of sale supplied at the time of order acknowledgment.

TI warrants performance of its components to the specifications applicable at the time of sale, in accordance with the warranty in TI's terms and conditions of sale of semiconductor products. Testing and other quality control techniques are used to the extent TI deems necessary to support this warranty. Except where mandated by applicable law, testing of all parameters of each component is not necessarily performed.

TI assumes no liability for applications assistance or the design of Buyers' products. Buyers are responsible for their products and applications using TI components. To minimize the risks associated with Buyers' products and applications, Buyers should provide adequate design and operating safeguards.

TI does not warrant or represent that any license, either express or implied, is granted under any patent right, copyright, mask work right, or other intellectual property right relating to any combination, machine, or process in which TI components or services are used. Information published by TI regarding third-party products or services does not constitute a license to use such products or services or a warranty or endorsement thereof. Use of such information may require a license from a third party under the patents or other intellectual property of the third party, or a license from TI under the patents or other intellectual property of TI.

Reproduction of significant portions of TI information in TI data books or data sheets is permissible only if reproduction is without alteration and is accompanied by all associated warranties, conditions, limitations, and notices. TI is not responsible or liable for such altered documentation. Information of third parties may be subject to additional restrictions.

Resale of TI components or services with statements different from or beyond the parameters stated by TI for that component or service voids all express and any implied warranties for the associated TI component or service and is an unfair and deceptive business practice. TI is not responsible or liable for any such statements.

Buyer acknowledges and agrees that it is solely responsible for compliance with all legal, regulatory and safety-related requirements concerning its products, and any use of TI components in its applications, notwithstanding any applications-related information or support that may be provided by TI. Buyer represents and agrees that it has all the necessary expertise to create and implement safeguards which anticipate dangerous consequences of failures, monitor failures and their consequences, lessen the likelihood of failures that might cause harm and take appropriate remedial actions. Buyer will fully indemnify TI and its representatives against any damages arising out of the use of any TI components in safety-critical applications.

In some cases, TI components may be promoted specifically to facilitate safety-related applications. With such components, TI's goal is to help enable customers to design and create their own end-product solutions that meet applicable functional safety standards and requirements. Nonetheless, such components are subject to these terms.

No TI components are authorized for use in FDA Class III (or similar life-critical medical equipment) unless authorized officers of the parties have executed a special agreement specifically governing such use.

Only those TI components which TI has specifically designated as military grade or "enhanced plastic" are designed and intended for use in military/aerospace applications or environments. Buyer acknowledges and agrees that any military or aerospace use of TI components which have **not** been so designated is solely at the Buyer's risk, and that Buyer is solely responsible for compliance with all legal and regulatory requirements in connection with such use.

TI has specifically designated certain components as meeting ISO/TS16949 requirements, mainly for automotive use. In any case of use of non-designated products, TI will not be responsible for any failure to meet ISO/TS16949.

Products

Audio	www.ti.com/audio
Amplifiers	amplifier.ti.com
Data Converters	dataconverter.ti.com
DLP® Products	www.dlp.com
DSP	dsp.ti.com
Clocks and Timers	www.ti.com/clocks
Interface	interface.ti.com
Logic	logic.ti.com
Power Mgmt	power.ti.com
Microcontrollers	microcontroller.ti.com
RFID	www.ti-rfid.com
OMAP Applications Processors	www.ti.com/omap
Wireless Connectivity	www.ti.com/wirelessconnectivity

Applications

Automotive and Transportation	www.ti.com/automotive
Communications and Telecom	www.ti.com/communications
Computers and Peripherals	www.ti.com/computers
Consumer Electronics	www.ti.com/consumer-apps
Energy and Lighting	www.ti.com/energy
Industrial	www.ti.com/industrial
Medical	www.ti.com/medical
Security	www.ti.com/security
Space, Avionics and Defense	www.ti.com/space-avionics-defense
Video and Imaging	www.ti.com/video

TI E2E Community

e2e.ti.com