

MOLEX P/N	CONTACT PLATING	DIM "B"	P.C.B THICKNESS
87715-9900	GOLD 15	3.00	2.36
87715-9901	MICROINCH	2.54	1.58
87715-9922	GOLD 30	2.54	1.58
87715-9923	MICROINCH	3.00	2.36

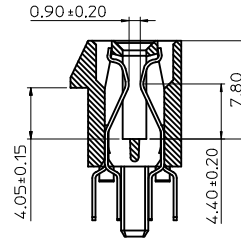

SECTION A-A

- NOTES:
- MATERIALS:
HOUSING: NYLON 46, GLASS FIBER FILLED UL94V-0
COLOR:BLACK
TERMINAL: PHOSPHOR BRONZE
 - PLATING:
TERMINAL :
CONTACT AREA: SEE TABLE
SOLDER TAIL: TIN, THICKNESS = 100 MICROINCH MIN.
UNDER PLATING: NICKEL OVERALL
 - WEEK CODE: XX(YEAR), XX(WEEK), X(LOCATION)
 - PRODUCT SPECIFICATION REFER TO PS-87715-200
 - PACKAGE SPECIFICATION REFER TO PK-87715-201
 - TEST SUMMARY: REFER TO TS-87715-209
 - CHAMFER EDGES MUST BE FREE OF CUTTING BURRS.
 - LEAD FREE AND ROHS COMPLIANCE PRODUCT.

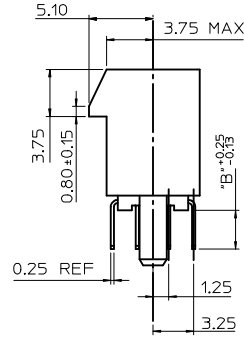
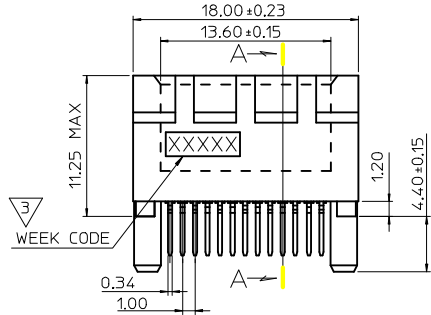
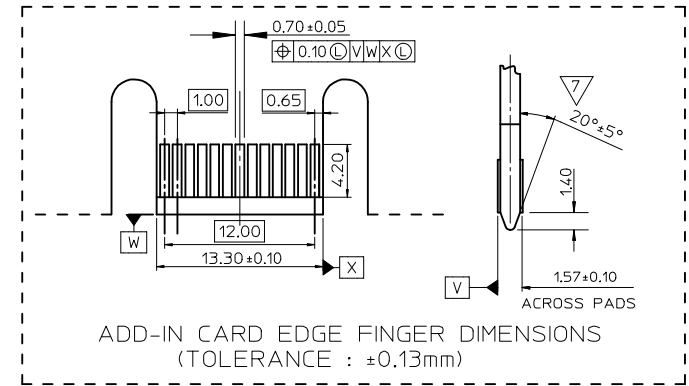
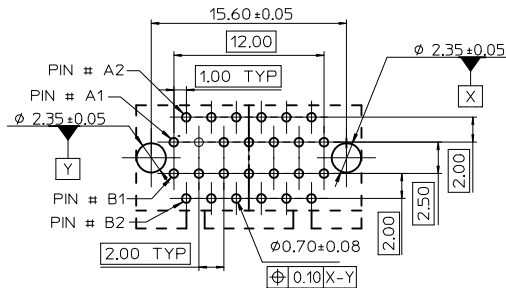
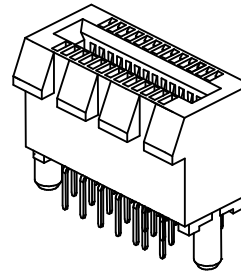
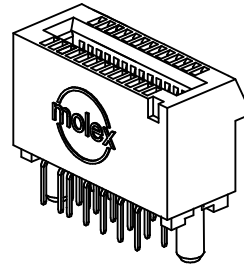
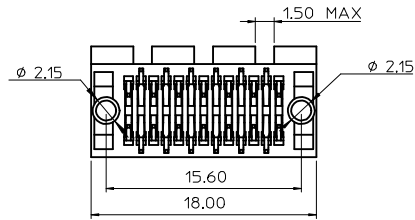

RECOMMENDED PCB LAYOUT

NEW RELEASED EC NO: SH2006-0194 DRAWN:ALL IN 2006/04/18 CHKD: 2006/04/18 APPR:WWSCHANG 2006/04/18	QUALITY SYMBOLS ▽=0 ◁=0	GENERAL TOLERANCES (UNLESS SPECIFIED)		DIMENSION STYLE MM/IN		SCALE	DESIGN UNITS METRIC	THIRD ANGLE PROJECTION
			mm	INCH	DRAWN BY TOM	DATE 2005/03/15	TITLE 1.00MM PITCH EDGE CARD 26 PIN VERT CONNECTOR (LEAD FREE VERSION)	
A	DESCRIPTION	4 PLACES ± --- ± ---	3 PLACES ± --- ± ---	2 PLACES ± 0.25 ± ---	1 PLACE ± 0.25 ± ---	CHECKED BY ALL IN	DATE 2005/03/15	
		DRAFT WHERE APPLICABLE MUST REMAIN WITHIN DIMENSIONS		ANGULAR ± 3 °		APPROVED BY WWSCHANG	DATE 2005/03/15	molex MOLEX INCORPORATED
	REV	SIZE A 4		MATERIAL NO. SEE TABLE		DOCUMENT NO. SD-87715-209		SHEET NO. 1 OF 1