

0.551 [14.00] MAX  
CABLE DIAMETER

GROUNDING  
SCREW  
(PHILLIPS)



HOUSING  
SCREW  
(PHILLIPS)



MOUNTING  
SCREW  
(PHILLIPS)



CABLE  
SLOT  
COVER

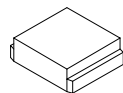

CABLE DIAMETER

0.551 [14.00] MAX

**MATERIAL:**

BACKSHELL: ZINC ALLOY  
 COVER: ZINC ALLOY  
 MOUNTING SCREWS: STEEL, NICKEL PLATED  
 HOUSING SCREWS: STEEL, ZINC PLATED  
 GROUNDING SCREW: STEEL, ZINC PLATED  
 CABLE SLOT COVER: ZINC ALLOY  
 OPERATING TEMP: -55°C TO +90°C

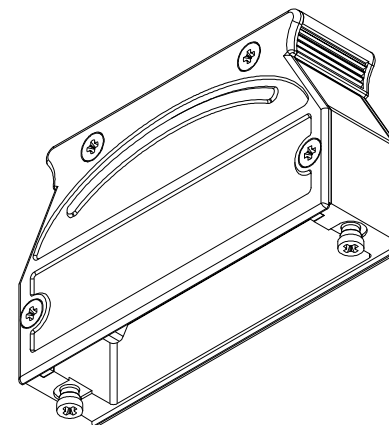

**BACKSHELL KIT INCLUDES:**

- (1) BACKSHELL
- (1) BACKSHELL COVER
- (2) MOUNTING SCREWS (#4-40)
- (4) HOUSING SCREWS (M2.5x0.45)
- (1) GROUNDING SCREW (M2.5x0.45)
- (2) CABLE SLOT COVER

\*\*SEE PAGE 2 FOR CABLE CLAMPS

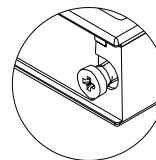

Mounting screw(s) shown to the left will not mate with any NorComp current hardware options. Please refer to NorComp 975M Series product page for slide lock hardware options (purchased separately).

UNITS = inch [mm]

**DO NOT SCALE FROM DRAWING**

**NorComp**

SCALE:  
NTS

SHEET 1 OF 2

REV 3

DWG NO.

**975M050-030R121**

**RoHS COMPLIANT**



THESE DRAWINGS AND SPECIFICATIONS ARE THE PROPERTY OF NorComp AND SHALL NOT BE REPRODUCED, COPIED OR USED AS THE BASIS FOR THE MANUFACTURE OR SALE OF APPARATUS WITHOUT WRITTEN PERMISSION.

DRAWN:  
**M. SIGMON**

DATE:  
**01/14/2014**

## CABLE CLAMPS ORDERED SEPARATELY

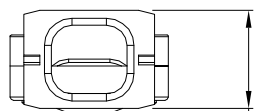

0.563 [14.3]

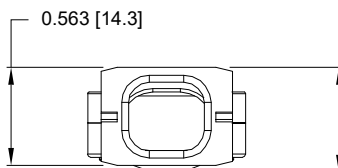

0.603 [15.3]

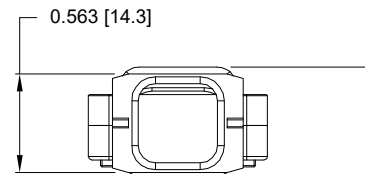

0.673 [17.1]

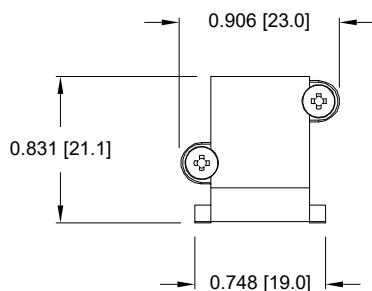

P/N 955-50-SR-8-10  
CABLE RANGE = 0.315 - 0.394

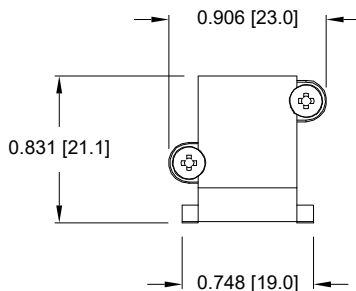

P/N 955-50-SR-11-14  
CABLE RANGE = 0.433 - 0.551

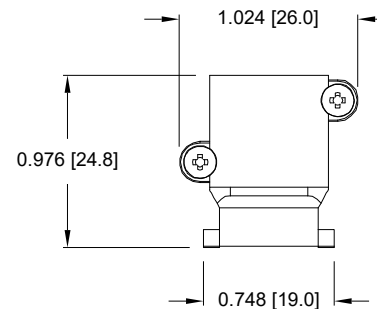

P/N 955-50-SR-14-16  
CABLE RANGE = 0.551 - 0.630

RoHS COMPLIANT

UNITS = inch

DO NOT SCALE FROM DRAWING



THESE DRAWINGS AND SPECIFICATIONS ARE THE PROPERTY OF NorComp AND SHALL NOT BE REPRODUCED, COPIED OR USED AS THE BASIS FOR THE MANUFACTURE OR SALE OF APPARATUS WITHOUT WRITTEN PERMISSION.

DRAWN:  
M. SIGMON

DATE:  
01/14/2014

NorComp

SCALE:  
NTS

SHEET 2 OF 2

REV 3

DWG NO.

975M050-030R121