

Amia Cellular SMD Antenna

Part No. A10376

aidaNOVA®

Product Specification

1 Features

- GSM/UMTS antenna supporting 4-5 frequency bands
- MDA antenna technology provides resistance to de-tuning
- High efficiency
- Easy to integrate
- Intended for SMD mounting
- Supplied in tape on reel

Amia supports the following communication standards:

GSM/GPRS/EDGE	CDMA200 1XRTT/EV-DO/EV-DV	UMTS WCDMA/HSPA	Other Standards
GSM850 (E)GSM900 GSM1800 (DCS) GSM1900 (PCS)	Band Classes: 1,2,3,4,6,8,9,12,14,15	Bands I – VI Bands VIII - X	Korean PCS DECT TD-SCDMA AWS

2 Description

Amia A10376 uses a ground plane in order to radiate efficiently, but this ground plane must not extend underneath the antenna itself.

The antenna uses a matching circuit to achieve optimized results for the specific frequency bands that are required. This product specification shows the performance of the antenna when optimized to cover a typical quad-band reception: GSM850/900/1800/1900.

3 Applications

- Mobile handsets
- Femto / Pico base stations
- Tracker devices
- Machine-to-machine communication
- Remote monitoring



4 Part number

Amia: A10376



5 General data

Product name	Amia
Part Number	A10376
Frequency	824 – 960 MHz 1710 – 1990 MHz
Polarization	Linear
Operating temperature	-40 °C to +140 °C
Environmental condition test	ISO16750-4 5.1.1.1/5.1.2.1/5.3.2
Impedance with matching	50 Ω
Weight	1.14 g
Antenna type	SMD
Dimensions	36.4 x 6.4 x 3.2 [mm]

6 Electrical characteristics

	Typical performance	Conditions
Peak gain	-1.2dBi @ 960 MHz -1.9dBi @ 1740 MHz	All data measured on Antenna's reference board, part number A10376-U1 Data given for the 824MHz-960MHz and 1710MHz - 1990MHz frequency ranges
Average gain (Linear)	-1.6dBi 824-960 MHz -2.4dBi 1710-1990 MHz	
Minimum efficiency 824-960 MHz 1710-217 MHz	>60% >50%	
Minimum Return Loss	6.8 dB	

7 Electrical performance

7-1 Return Loss

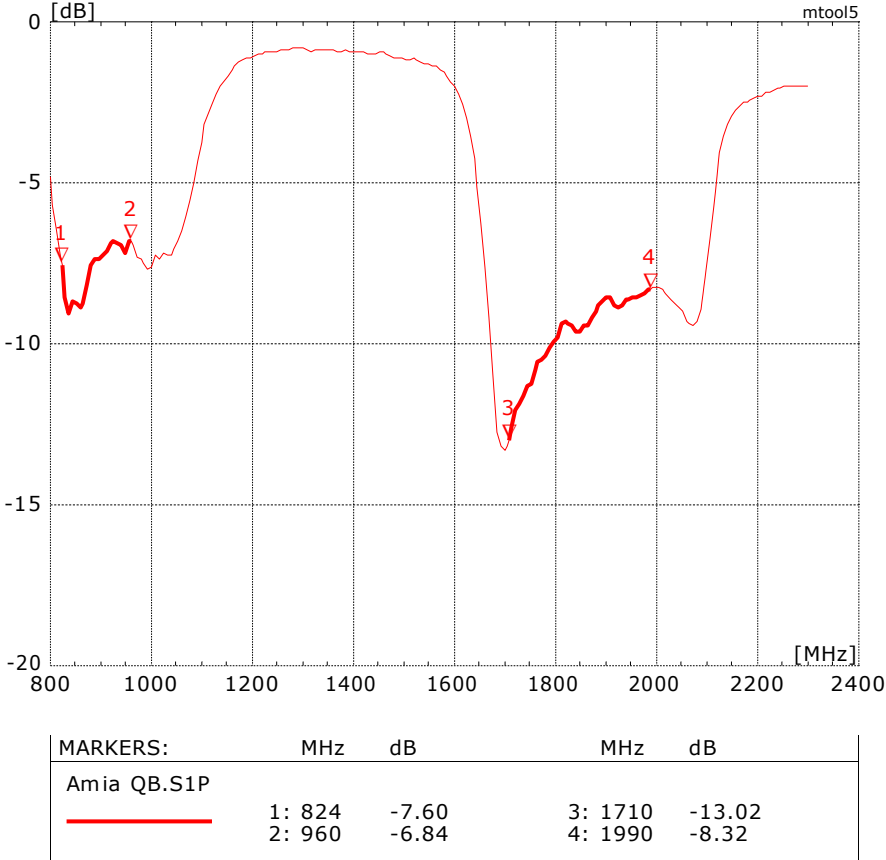

7-2 Antenna patterns 824-960 MHz

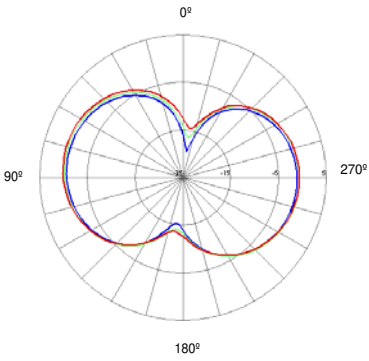
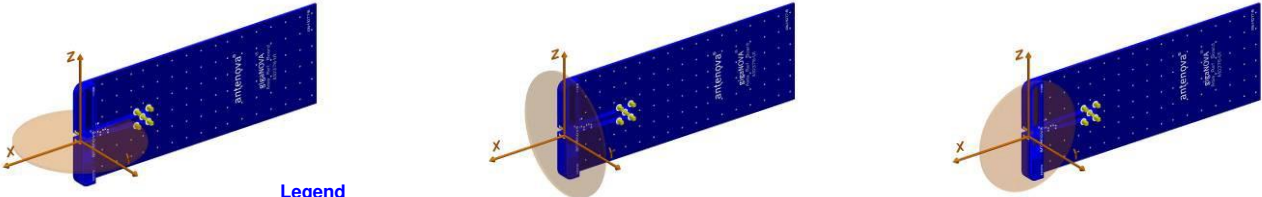
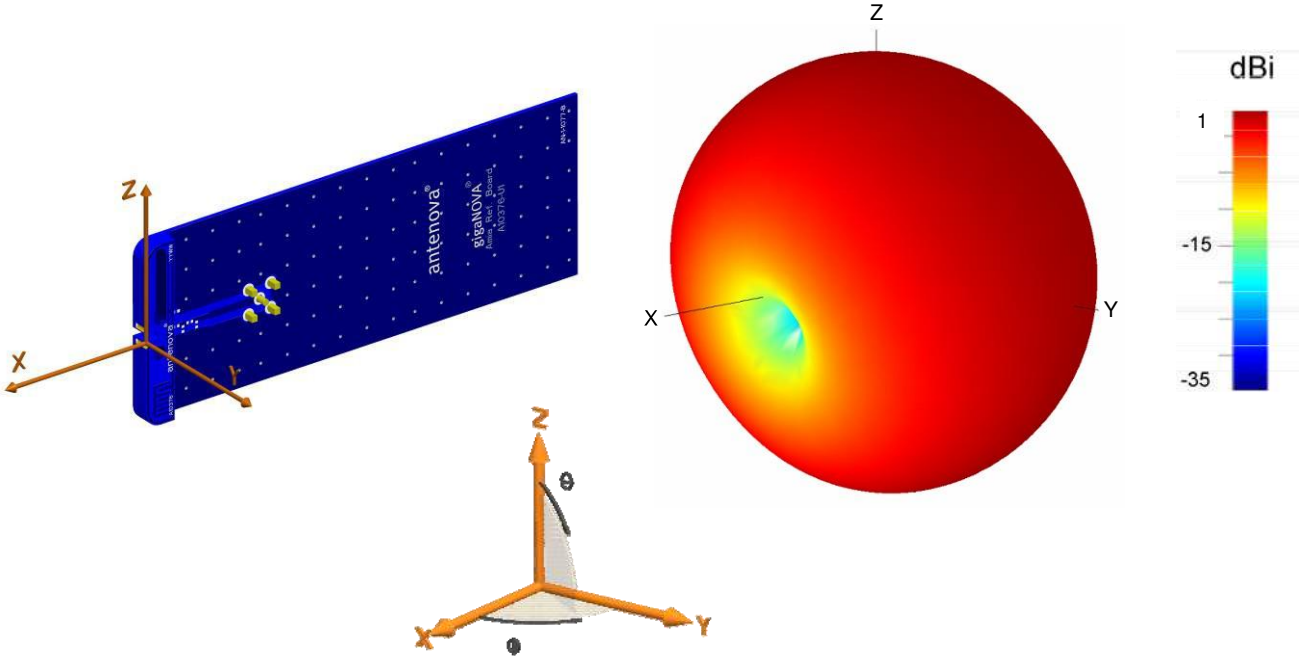

XY plane

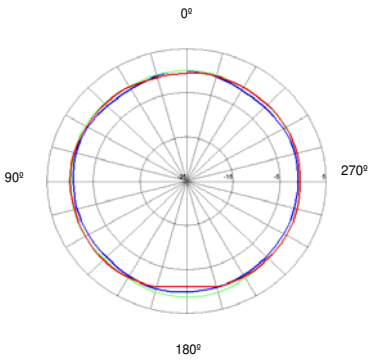

ZY plane

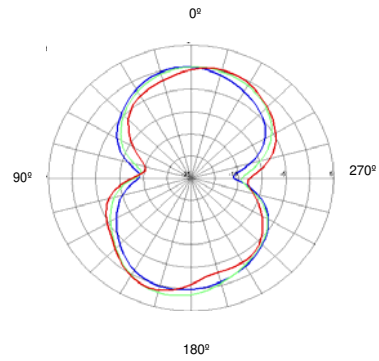

XZ plane

Patterns show combined polarisations measured on reference board A10376-U1. 3D Pattern measured at 890MHz

7-3 Antenna patterns 1710 – 1990 MHz

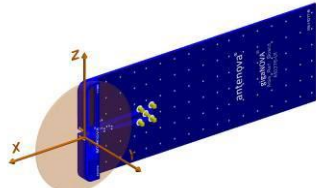
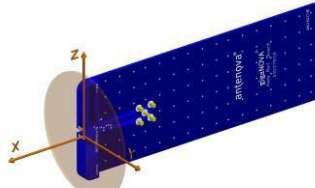
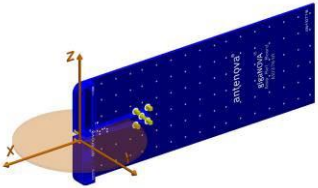
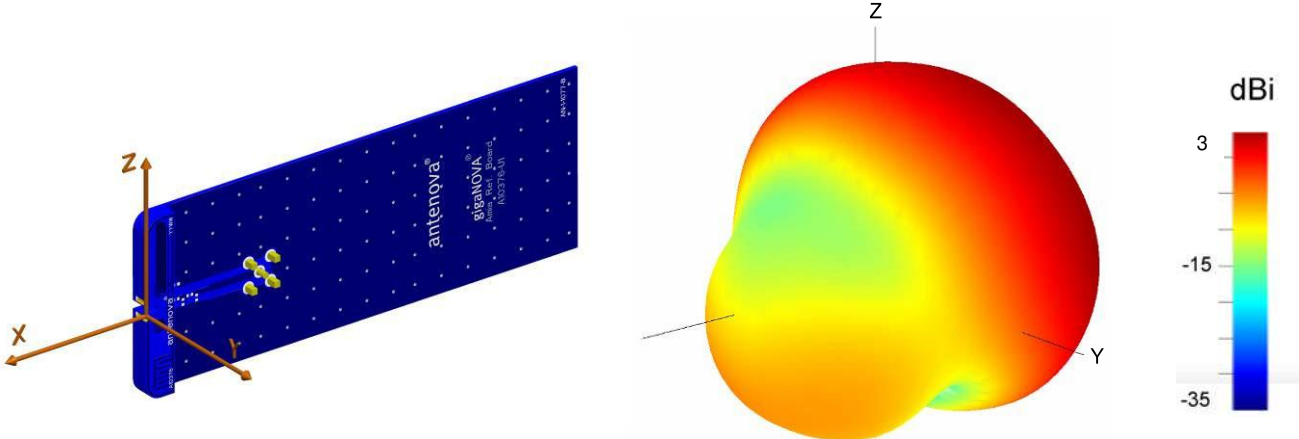

Legend
 — 1710.00(MHz)
 — 1850.00(MHz)
 — 1990.00(MHz)

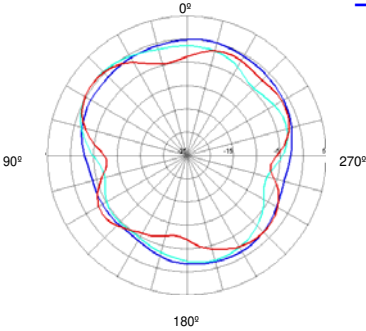

XY plane

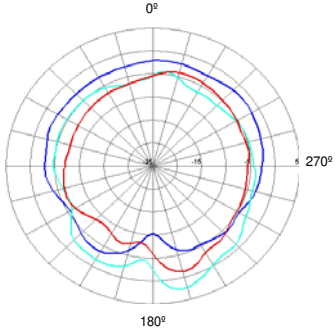

ZY plane

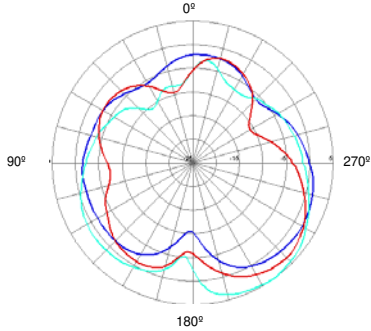

XZ plane

Patterns show combined polarisations measured on reference board A10376-U1M. 3D Pattern measured at 1850MHz

8 Antenna efficiency

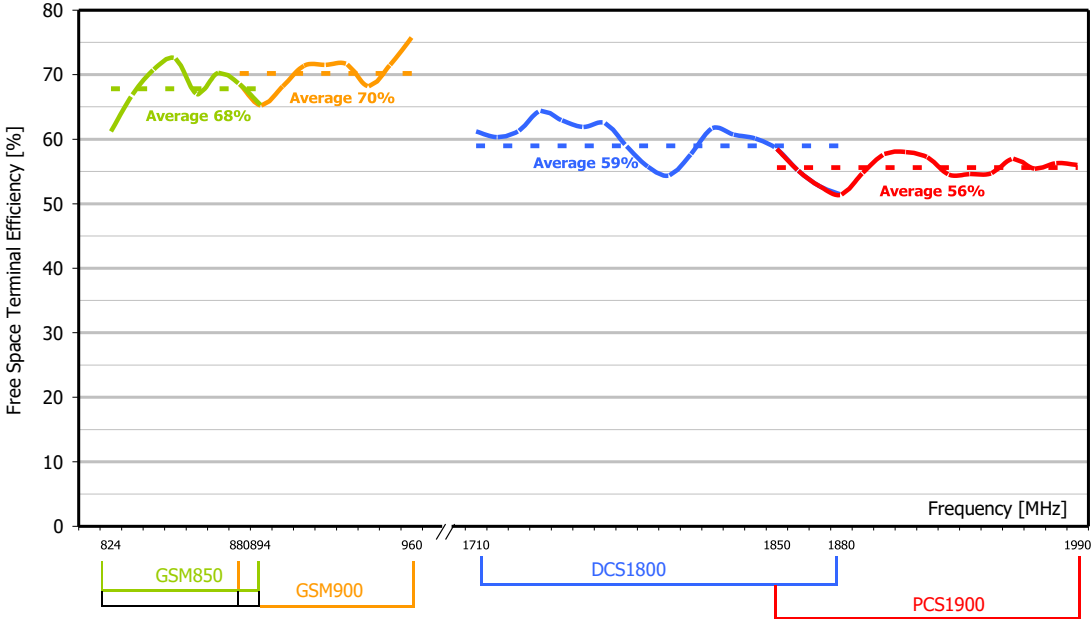

9 Antenna dimensions

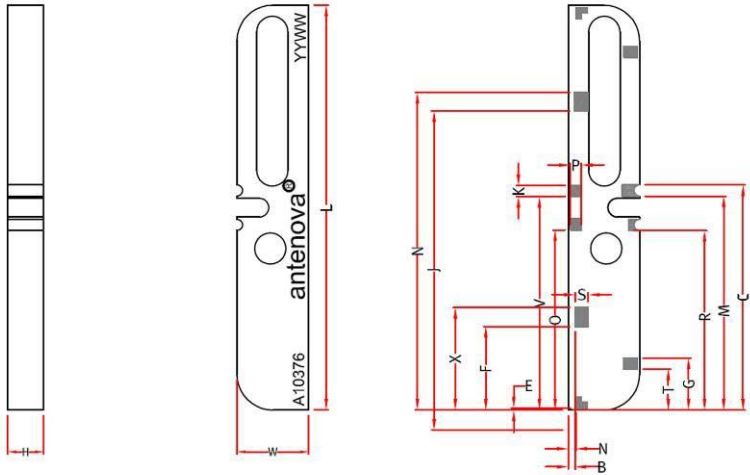

L	W	H	E	N	T	G	R	M	V
36.4 +/- 0.2	6.4 +/- 0.2	3.2 +/- 0.15	0.2 +/- 0.15	0.7 +/- 0.15	3.69 +/- 0.15	4.69 +/- 0.15	16.15 +/- 0.15	19.25 +/- 0.15	19.2 +/- 0.15
O	K	P	C	B	S	F	X	J	N
16.2 +/- 0.15	1.0 +/- 0.15	1.0 +/- 0.15	20.25 +/- 0.15	0.62 +/- 0.15	1.2 +/- 0.15	7.53 +/- 0.15	9.23 +/- 0.15	26.88 +/- 0.15	28.58 +/- 0.15

Dimensions in mm

10 Antenna footprint

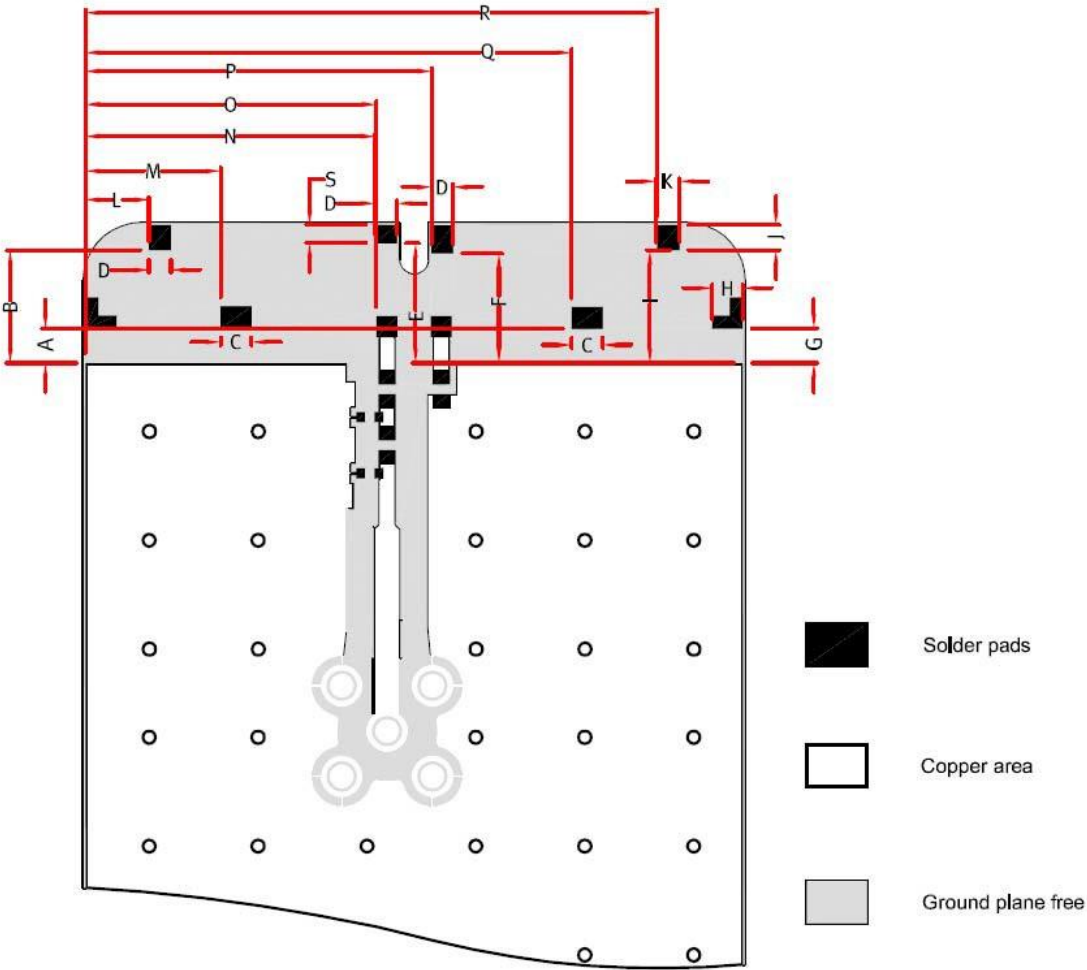

Amia Quad-band (Part No: A10376)

CAD files of the antenna footprint are available from www.antenova-m2m.com.

A	B	C	D	E	F	G	H	I	J	K	L	M
1.8 +/-0.1	6.20 +/-0.1	1.7 +/-0.1	1.2 +/-0.1	6.6 +/-0.1	6.0 +/-0.1	1.9 +/- 0.1	1.69 +/-0.1	6.26 +/-0.1	1.4 +/-0.1	1.27 +/- 0.1	3.5 +/- 0.1	7.46 +/- 0.1
N	O	P	Q	R	S							
15.9 +/-0.1	16.00 +/-0.1	19.0 +/-0.1	26.795 +/-0.1	31.55 +/-0.1	1.05 +/-0.1							

Dimensions in mm

11 Electrical interface

11-1 Transmission lines

The antenna should be connected using an RF transmission line.

All transmission lines should be designed to have a characteristic impedance of 50Ω .

The length of the transmission lines should be kept to a minimum. Any other parts of the RF system like transceivers, power amplifiers, etc, should also be designed to have an impedance of 50Ω .

Once the material for the PCB has been chosen (PCB thickness and dielectric constant), a co-planar transmission line can easily be designed using any of the commercial software packages for transmission line design. For the chosen PCB thickness, copper thickness and substrate dielectric constant, the program will calculate the appropriate transmission line width and gaps on either side of the track so the characteristic impedance of the co-planar transmission line is 50Ω .

11-2 Matching circuit, feed pad, and ground pad

The antenna requires a matching circuit that must be optimized for each customer's product. The matching circuit will require up to five components depending on the impedance of the antenna when situated in the device, and pads have been designed for 0603 components for best results. In addition to the matching circuit, a separate DC blocking capacitor will also be required between the radio and the antenna matching circuit.

Important: The position of the antenna feed and ground pads are fixed for this product and the positions cannot be swapped over. The feed pad must be placed on the left side of the antenna and the ground pad on the right side of the antenna.

The following pad layout should be designed into the device so the correct circuit can be installed:

Components depending on layout

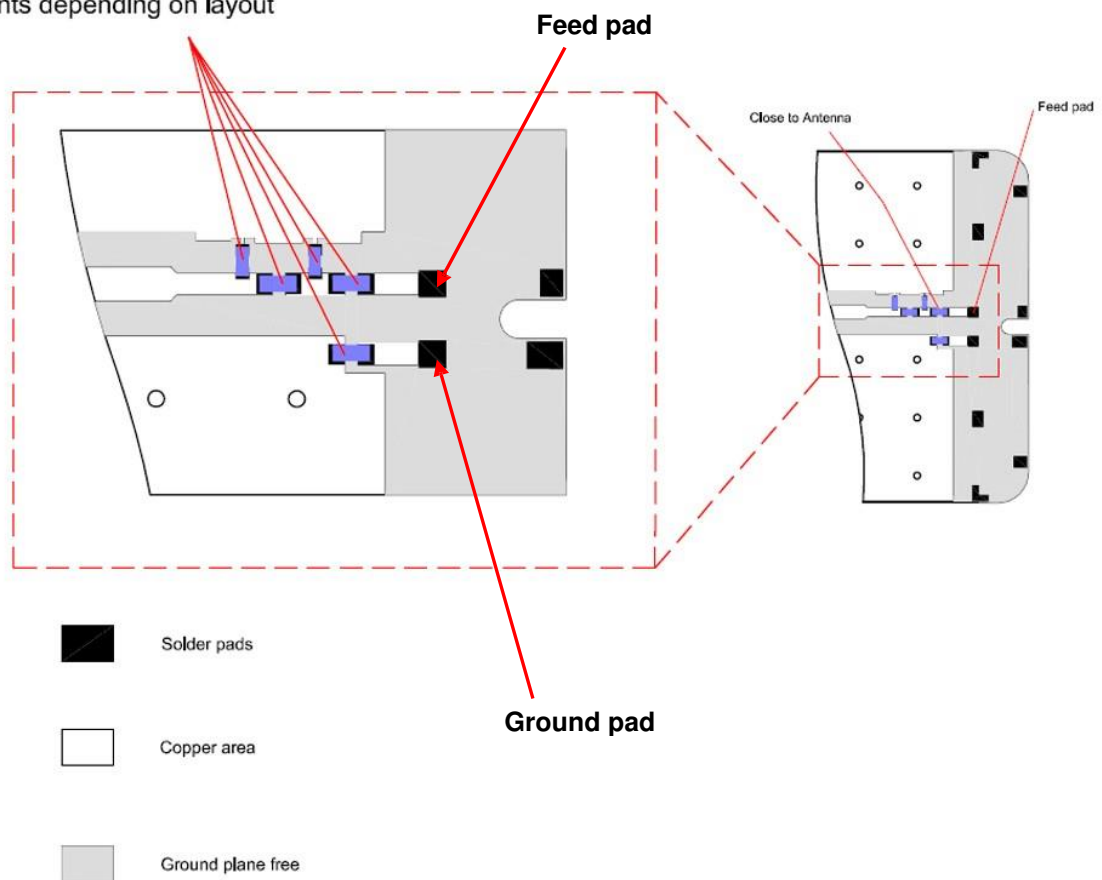

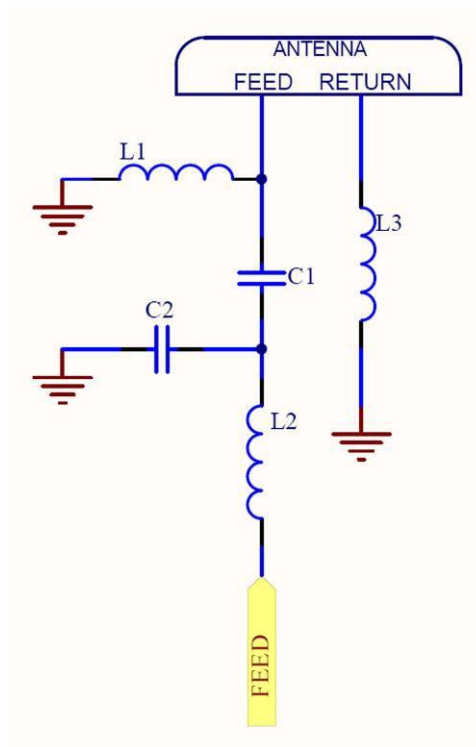

The values of the matching component given in below table are for the A10376-U1 reference boards **and might be different on a customer host board.**

Designator	Value	Manufacturer PN
L1	12nH	Murata LQW18AN12NG00
L2	4.3nH	Murata LQG15HN4N3S02
L3	3.3nH	Murata LQG15HN3N3S02
C1	1.6pF	Murata GJM1555C1H1R6BB01D
C2	DNP	

Note: The component values for the matching circuit will vary depending on the size of the PCB and surrounding components. The impedance of the antenna should be measured before selecting suitable matching components. Antenova offers a matching service on request. Contact info@antenova.com for further information.

11-3 Antenna placement

Amia should be fitted to the device so that power from the antenna can radiate into free space. Antenova strongly recommends placing the antenna near the top edge of the board. Maximum antenna performance is achieved by placing the antenna in the middle of the PCB with few components or metal objects nearby. The placements shown here are for guidance only, as the actual performance differences will depend on each individual device.

Antenova offers a full range of development support to ensure efficient implementation of the antenna into the specific design. To overcome RF design issues, matching circuits, transmission lines, layout and other components, please contact Antenova (info@antenova.com) for design and placement recommendations.



11-4 Reference boards

The reference board has been designed for evaluation purposes of Amia GSM antenna and it includes a SMA female connector. The reference board is available with Amia tuned to cover 4 bands: GSM850/900/1800/1900 - Part number: A10376-U1.

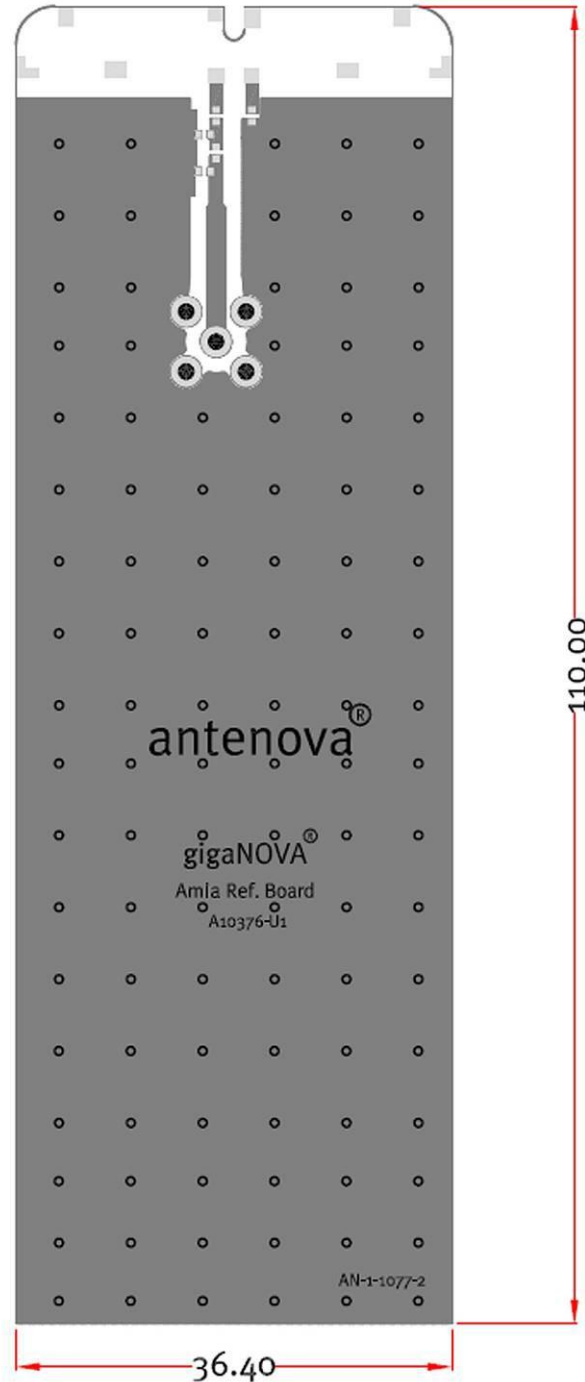

Dimensions in mm

Contact info@antenna.com for further information or to order a reference board.

12 Soldering

This antenna is suitable for lead free soldering.

The reflow profile should be adjusted to suit the PCBA, oven and solder paste, while observing the following conditions:

RECOMMENDED CONDITION OF REFLOW SOLDERING

- | | |
|------------------------------|-----------------------------------|
| 1.Pre Heating Rate | : 1 to 5 deg./s |
| 2.Pre Liminary Heating | : 130 to 170 deg. ,
50 to 120s |
| 3.Reflow Heating Rate | : 1 to 5 deg./s |
| 4.Soldering | : 230 deg. , 20 to 30s |
| 5.Peak Temperature | : 245 to 260 deg. ,
10s Max. |
| 6.Cooling | : 60s Min. |
| 7.Number of Reflow Soldering | : 2 times Max. |

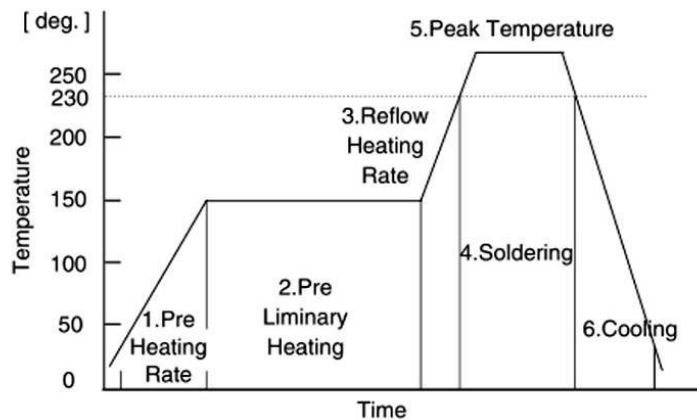

* Recommended peak temperature is over 245 degree. If peak temperature is below 245 degree., you may adjust the following parameters ; Time length of peak temperature (longer), Time length of soldering (longer), Thickness of solder paste (thicker).

13 Hazardous material regulation conformance

The antenna has been tested to conform to RoHS and REACH requirements and is Halogen Free. A certificate of conformance is available from Antenova.

14 Packaging

14-1 Optimal storage conditions for packaged reels

Temperature	-10°C to 40°C
Humidity	Less than 75% RH
Shelf Life	18 Months
Storage place	Away from corrosive gas and direct sunlight
Packaging	Reels should be stored in unopened sealed manufacturer's plastic packaging.

Note: Storage of open reels of antennas is not recommended due to possible oxidization of pads on antennas. If short term storage is necessary, then it is highly recommended that the bag containing the antenna reel is re-sealed and stored in like storage conditions as in above table.

14-2 Tape characteristics

Amia

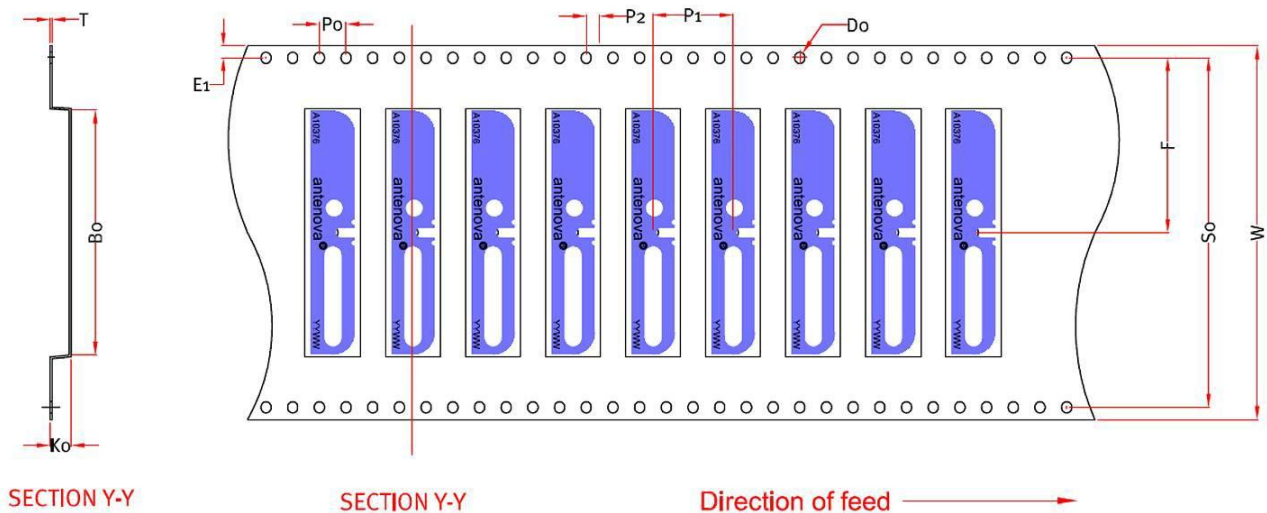

W	F	E1	P0	P1	P2	A0	B0	K0	SO	T	D0
56 ± 0.2	26.2 ± 0.1	1.75 ± 0.1	4 ± 0.1	12 ± 0.1	2 ± 0.1	8.3 ± 0.1	37.2 ± 0.1	3.6 ± 0.1	52.4 ± 0.1	0.4 ± 0.05	Min 1.5 +/- 0.1

Dimensions in mm

Quantity	Leading Space	Trailing Space
1000 pcs / reel	15 blank antenna holders	15 blank antenna holders

Antennas for Wireless M2M Applications

14-3 Reel dimensions

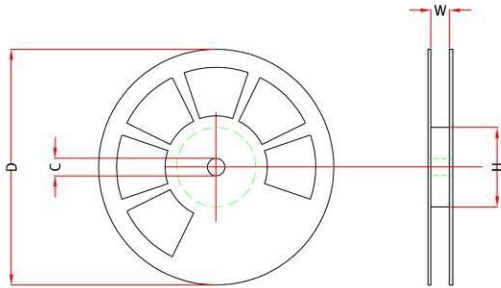

Width	Reel Diameter	Hub Diameter	Shaft Diameter
57.5 mm	330 ± 2.0 mm	80 mm	13 ± 0.5 mm

14-4 Box dimensions

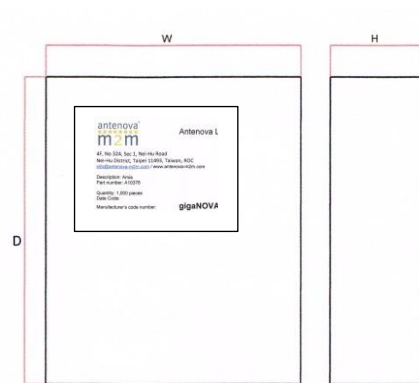

Width (W)	Breadth (B)	Thickness (H)
340 mm	353 mm	65 mm

14-5 Bag properties

Reels are supplied in protective plastic packaging

14-6 Reel label information

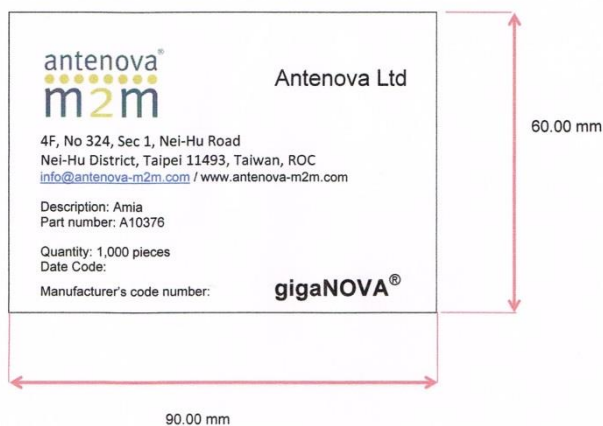

Amia

Dimensions in mm



Corporate Headquarters

Antenova Ltd.
2nd Floor, Titan Court
3 Bishop Square
Hatfield
Herts
AL10 9NA

Tel: +44 1223 810600
Email: sales@antenova.com

North America Headquarters

Antenova Ltd.
100 Brush Creek Road, Suite 103
Santa Rosa
California
95404 USA

Tel: +1 707 890 5202
Email: sales@antenova.com

Asia Headquarters

Antenova Asia Ltd.
4F, No. 324, Sec. 1, Nei-Hu Road
Nei-Hu District
Taipei 11493
Taiwan, ROC

Tel: +886 (0) 2 8797 8630
Fax: +886 (0) 2 8797 6890
Email: sales@antenova.com

Copyright® 2011 Antenova Ltd. All Rights Reserved. Antenova® Antenova M2M, RADIONOVA®, gigaNOVA® and the Antenova product family names, are trademarks of Antenova Ltd. Any other names and/or trademarks belong to their respective companies.

The materials provided herein are believed to be reliable and correct at the time of print. Antenova does not warrant the accuracy or completeness of the information, text, graphics or other items contained within these information. Antenova further assumes no responsibility for the use of this information, and all such information shall be entirely at the user's risk.



Certificate No: 4598

Antennas for Wireless M2M Applications