

RT8498 Step-Down Converter Evaluation Board

Purpose

The RT8498 is specifically designed to be operated in Buck, Boost and Buck-Boost converter applications. This document explains the function and use of the RT8498 evaluation board (EVB), and provides information to enable operation, modification of the evaluation board and circuit to suit individual requirements.

Table of Contents

Purpose.....	1
Introduction	2
Bench Test Setup Conditions.....	3
Schematic, Bill of Materials & Board Layout.....	5
More Information.....	10
Important Notice for Richtek Evaluation Board.....	10

Introduction

General Product Information

The RT8498 is a current-mode LED driver supporting wide input voltage range from 3V to 18V and output voltage up to 18V. With internal 350kHz operating frequency, the size of the external PWM inductor and input/output capacitors can be minimized. High efficiency is achieved by a 100mV current sensing control. LED dimming control can be done from either analog or PWM signal. The RT8498 provides an internal soft-start function to avoid inrush current and thermal shutdown to prevent the device from overheat. The RT8498 is available in the SOT-23-6 package.

Product Feature

- High Voltage : V_{IN} Up to 18V, V_{OUT} Up to 18V
- Built-In 2A Power Switch
- Current-Mode PWM Control
- 350kHz Fixed Switching Frequency
- Analog, PWM Digital or PWM Converting to Analog with One External Capacitor
- Internal Soft-Start to Avoid Inrush Current
- Under-Voltage Lockout
- Internal Over Voltage Protection to Limit Output Voltage
- Cycle-by Cycle Current Limit
- Thermal Shutdown

Key Performance Summary Table

Key Features	Evaluation Board Number: PCB082_V1
Default Input Voltage	4.5V to 18V
Max Output Current	1A
Default Output Voltage	3.0V
Default Marking & Package Type	RT8498GE, SOT-23-6
Operation Frequency	Steady 350kHz at all loads

Bench Test Setup Conditions

Headers Description and Placement

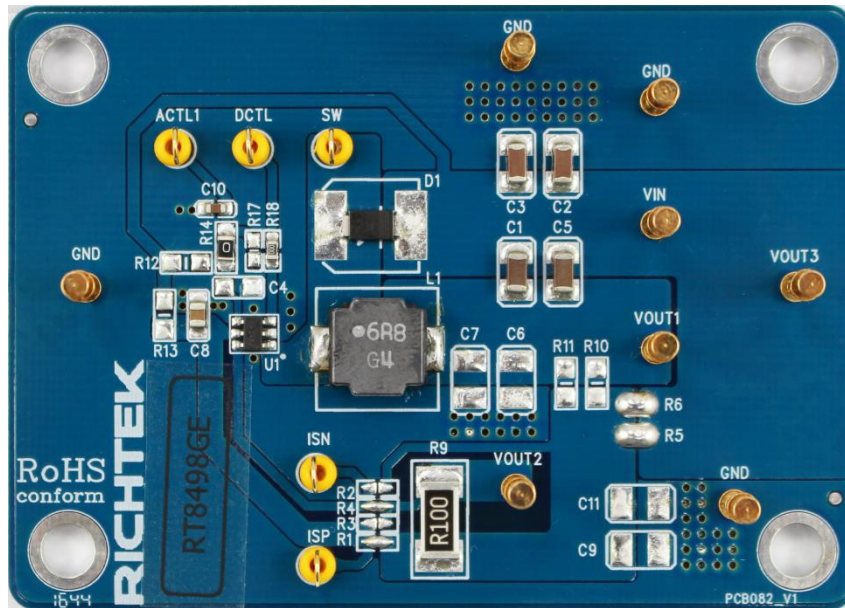

Carefully inspect all the components used in the EVB according to the following Bill of Materials table, and then make sure all the components are undamaged and correctly installed. If there is any missing or damaged component, which may occur during transportation, please contact our distributors or e-mail us at evb_service@richtek.com.

Test Points

The EVB is provided with the test points and pin names listed in the table below.

Test point/ Pin name	Signal	Comment (expected waveforms or voltage levels on test points)
SW	Switch node test point	Switch node of the PWM converter.
GND	Ground	Ground.
DCTL	DCTL Input Voltage	Digital dimming control input.
ACTL	ACTL Input Voltage	Analog dimming control input. Effective programming range is 0.65V to 1.2V.
VCC	Supply Voltage Input	Supply voltage input. For good bypass, connect a low ESR capacitor between this pin and GND.
ISN	Current sense input	Current sense input. Voltage threshold between VCC and ISN is 100mV.

Power-up & Measurement Procedure

1. Connect input power ($4.5V < V_{IN} < 18V$) and input ground to VIN and GND test pins respectively.
2. Connect positive end and negative terminals of load to VOUT2 and VOUT1 test pins respectively..
3. Verify the output voltage/output current (approximately 3.0V/1A) between VOUT2 and VOUT1.
4. $V_{IN} = 12V$, $V_{OUT} = 3V$, $I_{OUT} = 1A$ (Buck) ,
LED+ = VOUT2, LED- = VOUT1, LOAD = 1LEDs or Electronic Load CV mode
measure check SW pin freq = 350kHz , ISP-ISN Threshold = 100mV

LED Current Setting

The LED current can be calculated by the following equation :

$$I_{LED(MAX)} = \frac{(V_{VCC} - V_{ISN})}{R_{SENSE}}$$

where $(V_{VCC} - V_{ISN})$ is the voltage between the VCC and ISN pins (100mV typ. if ACTL dimming is not applied) and the R_{SENSE} is the resistor between the VCC and ISN pins.

Schematic, Bill of Materials & Board Layout

EVB Schematic Diagram

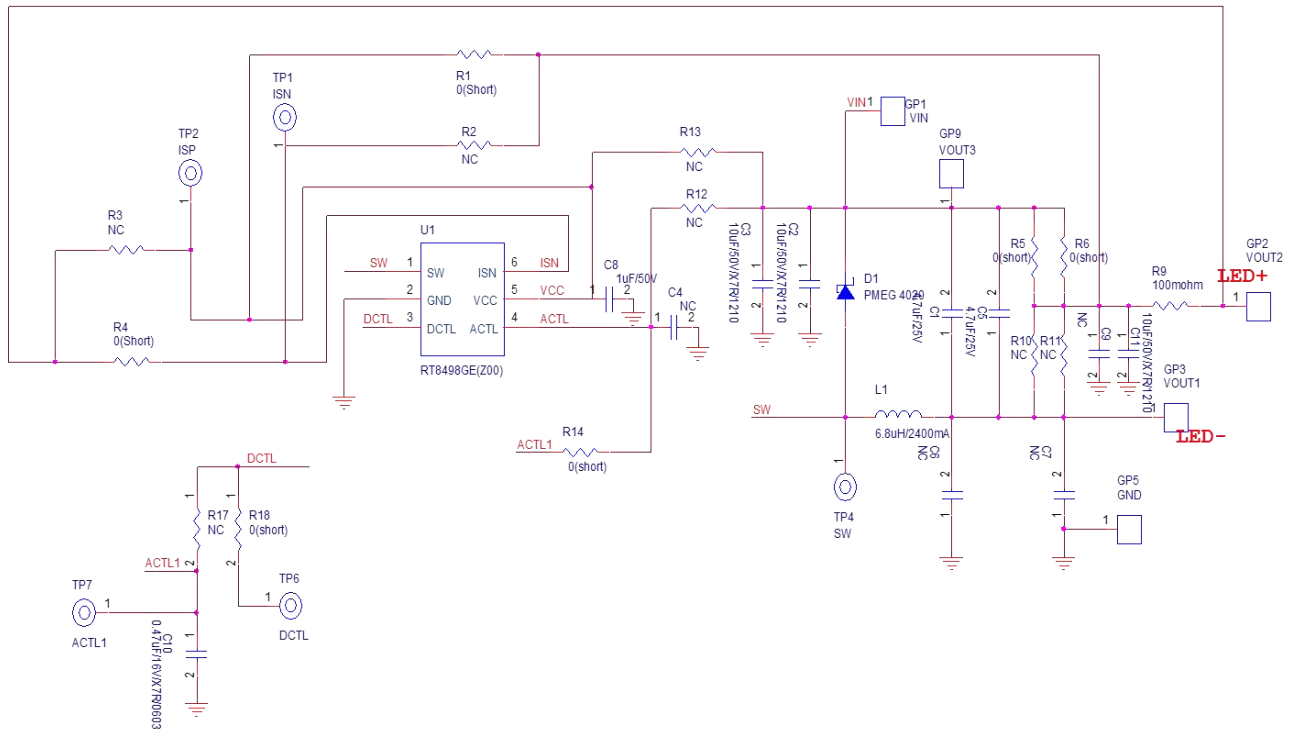

Bill of Materials

Reference	Qty	Part number	Description	Package	Manufacturer
U1	1	RT8498GE		SOT-23-6	Richtek
C1, C5	2	GRM31CR71H475KA12L	4.7μF/50V/X7R/1206	C-1210	muRata
C2, C3	2	C3216X5R1H106K160AB	10μF/50V/X7R/1206	C-1210	TDK
C4	1		NC	C-0805	
C6, C7	2		NC	C-1210	
C8	1	C2012X7R1H105KT	1μF/50V/X7R/0805	C-0805	TDK
C9, C11	2		NC	C-1210	TDK
C10	1	C1608X7R1C474K000N	0.47μF/16V/X7R/0603	C-0603	TDK
D1	1		PMEG 4020	D-CR-73	NXP
L1	1	NRS8040T6R8NJGJ	6.8μH	L-SU1028	TAIYO YUDEN
R1, R4	2		Short	CP-0603	
R2, R3	2		NC	CP-0603	
R5, R6	2		SHORT	CP-0805C	
R9	1	2512T-1-R100	100mohm	RC-1A	RALEC
R10, R11, R12, R13	4		NC	R-0805	
R14	1	RTT05000JTP	0R/0805	R-0805	RALEC
R17	1		NC	R-0603	
R18	1	WR06X000 PTL	0R/0603	R-0603	WALSIN

Efficiency:

V_{IN} (V)	I_{IN} (A)	V_{OUT} (V)	I_{OUT} (A)	Eff. (%)	ISP-ISN (mV)
4.5	0.834	3.405	0.974	88.369	97.9
7	0.538	3.395	0.978	88.165	98.3
10	0.379	3.382	0.974	86.915	97.9
12	0.317	3.372	0.972	86.162	97.7
15	0.257	3.369	0.97	84.771	97.6
18	0.216	3.368	0.966	83.68	97.3

Efficiency vs. V_{IN} ($L = 6.8\mu H / I_{OUT} = 1 A$)

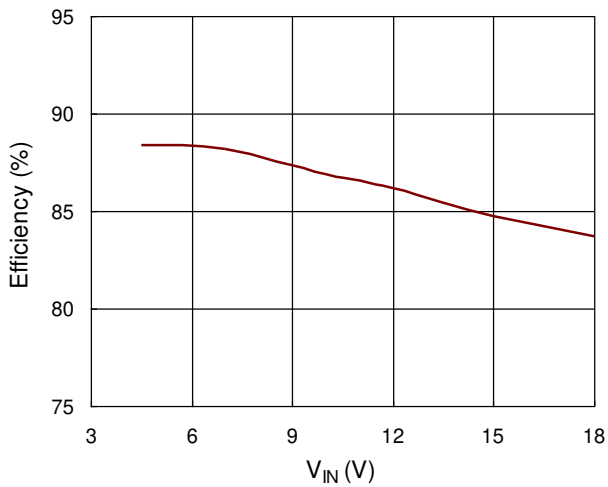

Line regulation:

I_{OUT} vs. Input Voltage

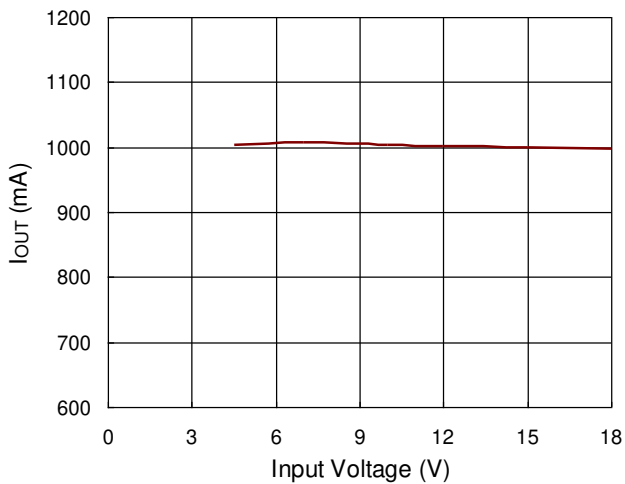

V_{IN} (V)	I_{OUT} (A)
4.5	995.2
7	986.1
10	981.8
12	981.5
15	979.1
18	976.8

Load regulation:

I_{OUT} vs. Output Voltage

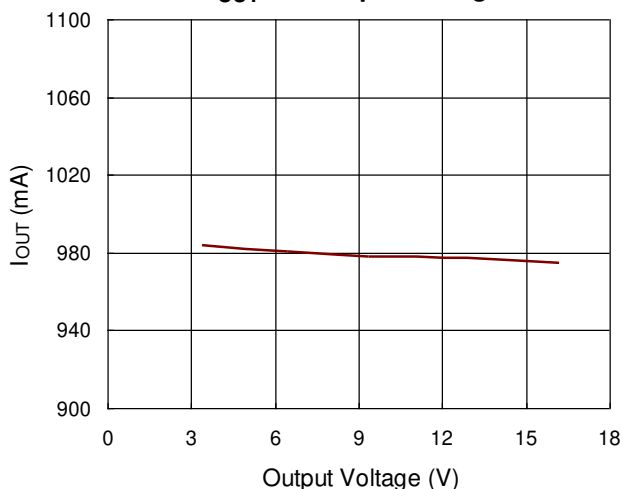

LEDs	V _{OUT} (V)	I _{OUT} (mA)
5LED	16.21	974.8
4LED	12.88	977.5
3LED	9.38	978.1
2LED	6.46	980.5
1LED	3.38	983.8

Waveform:

Test condition: V_{IN} = 10V, V_{OUT} = 3V, I_{OUT} = 1A

CH1 = SW, CH2 = V_{OUT}, CH3 = V_{IN}, CH4 = I_L

CH1 = SW, CH2 = V_{OUT}, CH3 = V_{IN}, CH4 = I_{OUT}

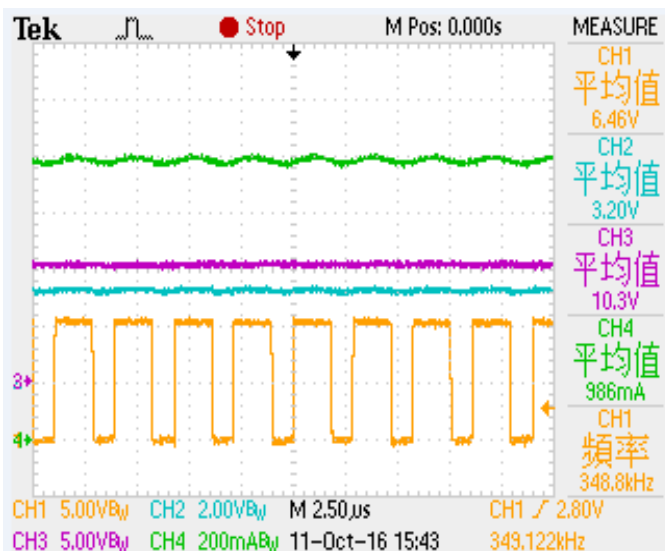
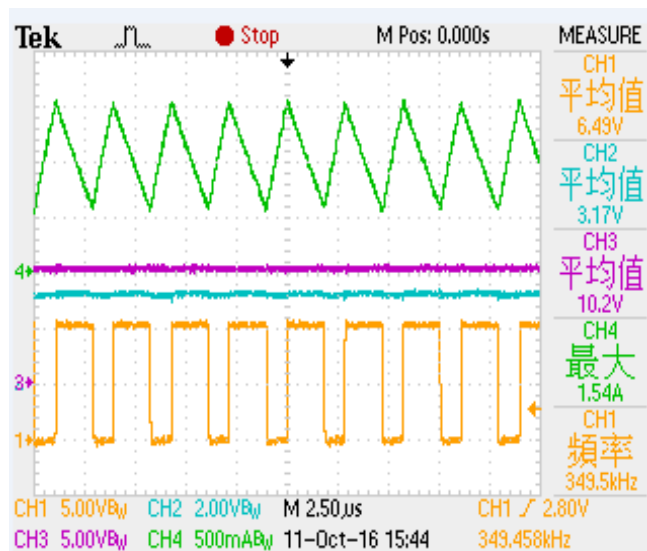

Analog / PWM Dimming :

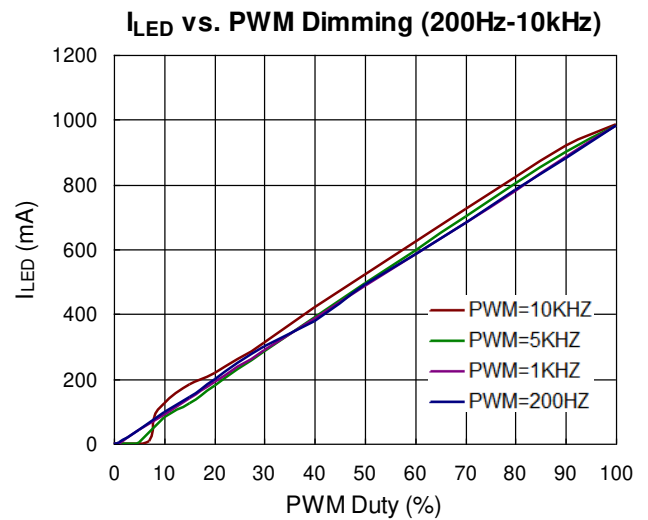
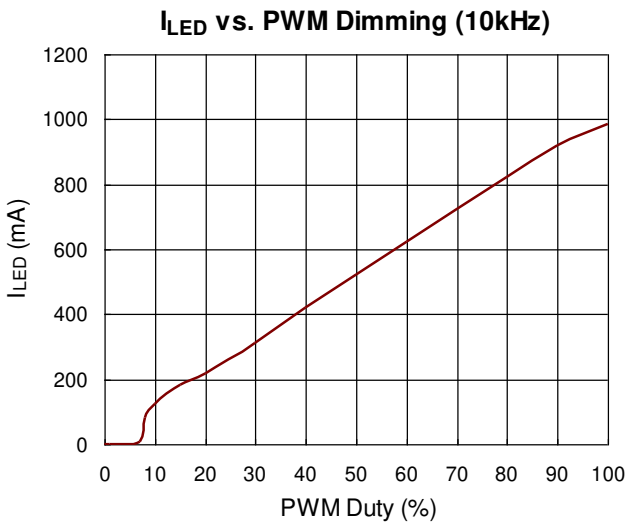
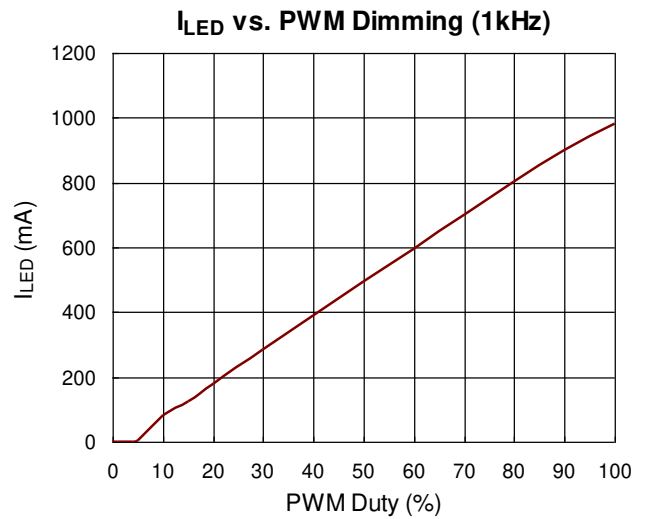
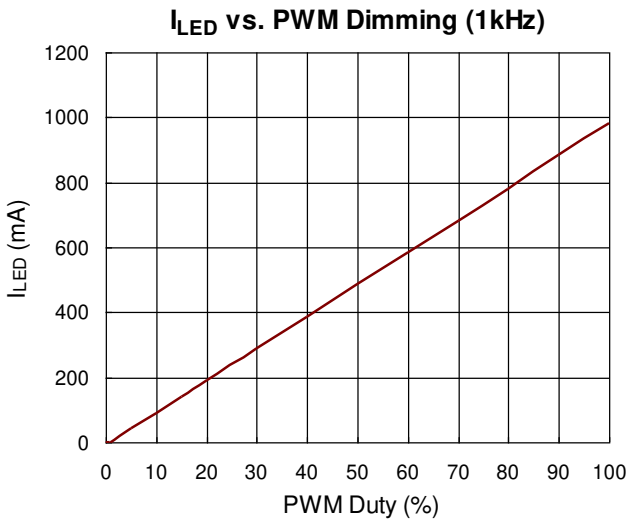
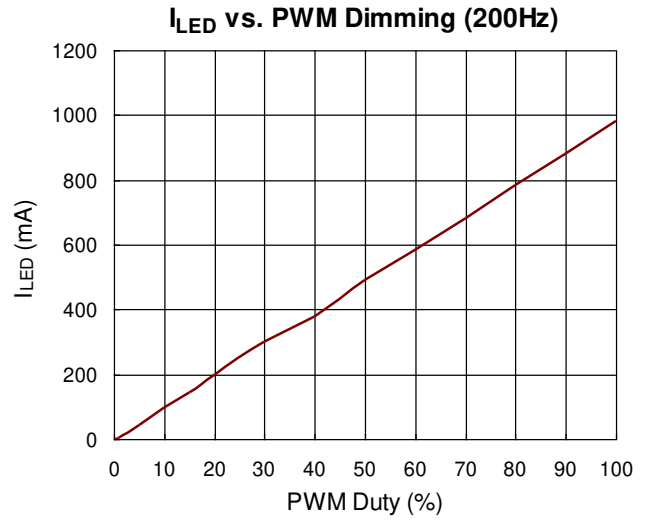
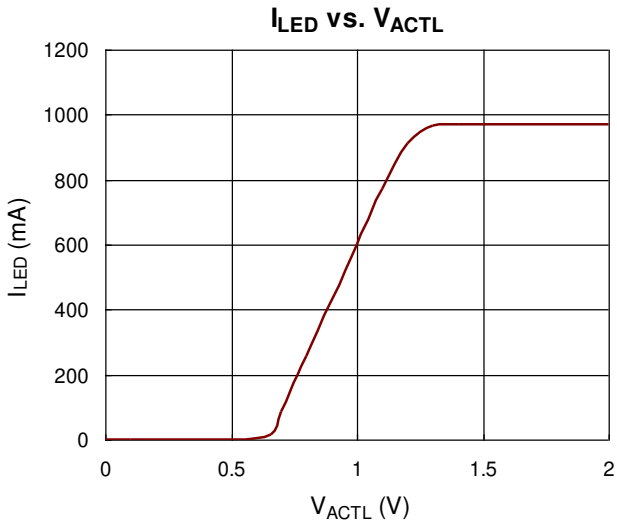

PCB Layout

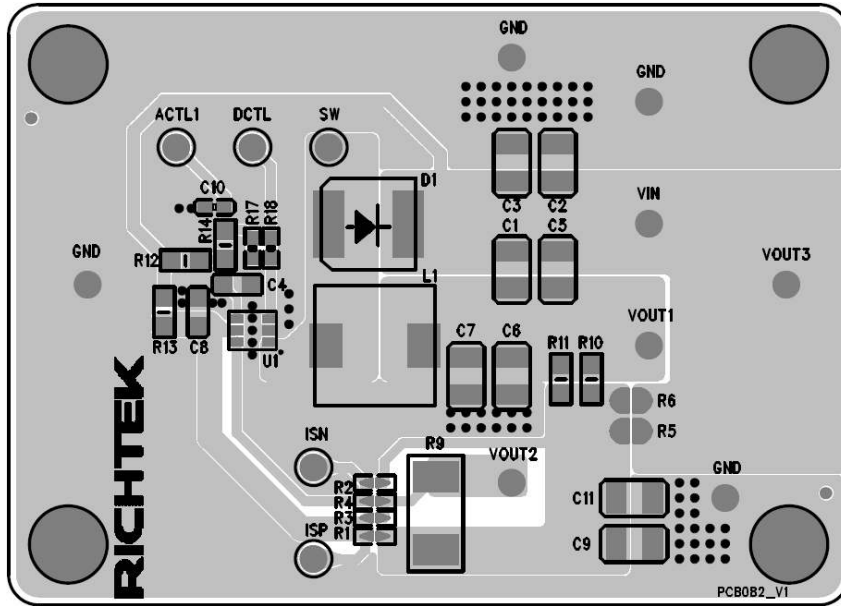

Top View (1st layer)

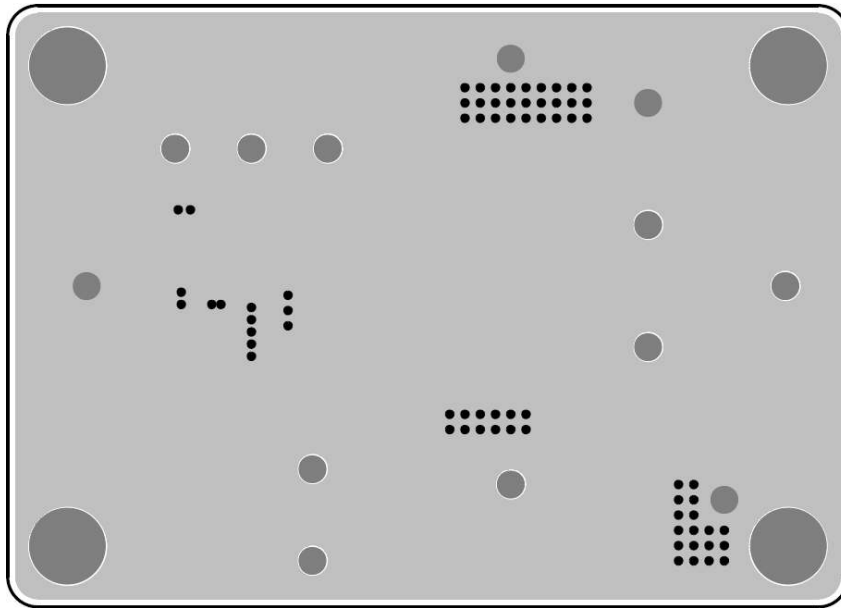

Bottom View (4th Layer)

More Information

For more information, please find the related datasheet or application notes from Richtek website <http://www.richtek.com>.

Important Notice for Richtek Evaluation Board

THIS DOCUMENT IS FOR REFERENCE ONLY, NOTHING CONTAINED IN THIS DOCUMENT SHALL BE CONSTRUED AS RICHTEK'S WARRANTY, EXPRESS OR IMPLIED, UNDER CONTRACT, TORT OR STATUTORY, WITH RESPECT TO THE PRESENTATION HEREIN. IN NO EVENT SHALL RICHTEK BE LIABLE TO BUYER OR USER FOR ANY AND ALL DAMAGES INCLUDING WITHOUT LIMITATION TO DIRECT, INDIRECT, SPECIAL, PUNITIVE OR CONSEQUENTIAL DAMAGES.