



Leaded Varistors

AdvanceD-MP series

Series/Type: SIOV-S10K460E2K1
Ordering code: B72210P2461K101
Date: 2013-09-18
Version: a

Applications

Overvoltage protection

Features

- UL approval to UL1449 (file number E321126), for use in Type 3 SPD's

SIOV nomenclature

S	=	Disk type
10	=	Rated disk diameter
K	=	Tolerance of V_V at 1mA : $\pm 10\%$
460	=	Max. AC voltage
E2...K1	=	Advanced-MP series

General technical data

Climatic category	to IEC 60068-1	40/85/56
Operating temperature	to IEC 61051	-40...+85 °C
Storage temperature		-40...+125 °C
Electric strength	to IEC 61051	$\geq 2.5 \text{ kV}_{\text{RMS}}$
Insulation resistance	to IEC 61051	$\geq 100 \text{ M}\Omega$
Response time		<25 ns

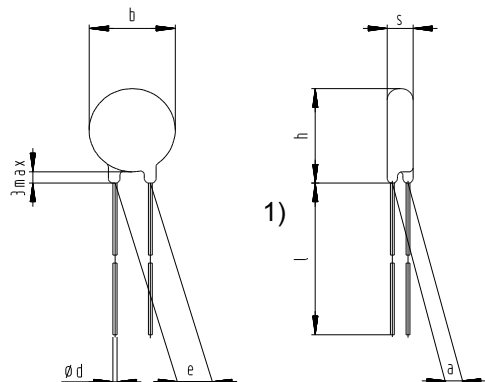
Dimensional drawings in mm

b_{\max}	=	12.5
h_{\max}	=	16.5
s_{\max}	=	8.4
e	=	7.5 ± 1.0
a	=	5.0 ± 1.0
l_{\min}	=	25.0
$\varnothing d$	=	0.8 ± 0.05

1) seating plane in accordance with IEC 60717

Electrical data
Maximum Ratings (85 °C)

Max. AC operating voltage

$$V_{\text{RMS}} = 460 \text{ V}$$

Max. DC operating voltage

$$V_{\text{DC}} = 615 \text{ V}$$

Surge current (8/20 μs)

1 time

$$I_{\text{max}} = 3500 \text{ A}$$

Energy absorption (2 ms)

1 time

$$W_{\text{max}} = 92 \text{ J}$$

Average power dissipation

$$P_{\text{max}} = 0.40 \text{ W}$$

Characteristics (25 °C):

Varistor voltage at 1 mA

$$V_V = 750 \text{ V} \pm 10\%$$

Clamping voltage at 25 A (8/20 μs)

$$V_{\text{C,max}} = 1240 \text{ V}$$

Typ. capacitance at 1 kHz

$$C = 190 \text{ pF}$$

V/I Characteristic

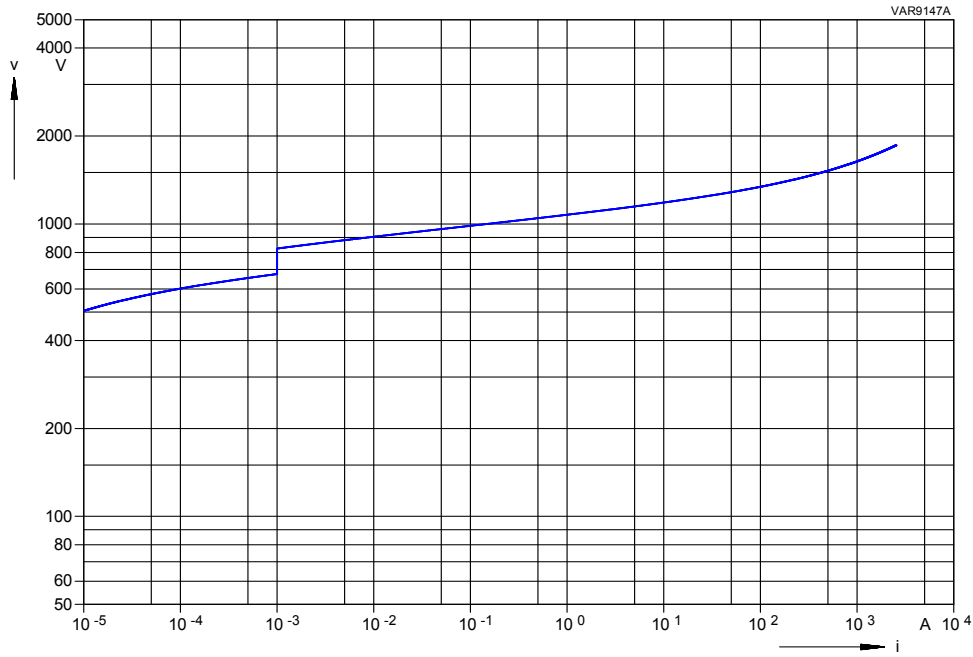

Derating

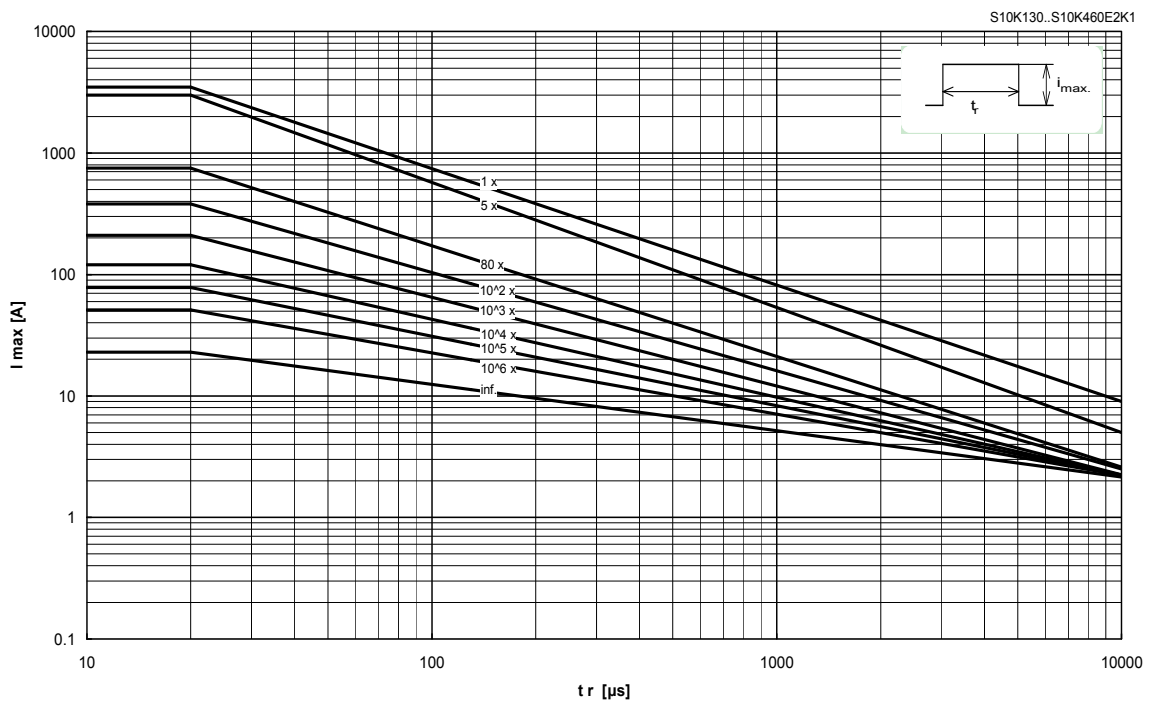

Reliability Data Electrical

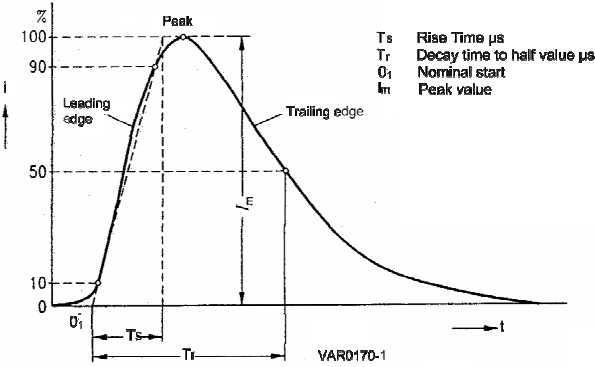
Characteristics	Test Methods/Description	Specifications
Varistor Voltage	The voltage between two terminals with the specified measuring current applied is called V_v (1 mA _{DC} @ 0.2 ... 2 s).	To meet the specified value.
Clamping Voltage	<p>The maximum voltage between two terminals with the specified standard impulse current (8/20µs) illustrated below applied.</p> 	To meet the specified value.
Surge current derating, 8/20 µs	10 surge currents (8/20 µs), unipolar, interval 30 s, amplitude corresponding to derating curve for 10 impulses at 20 µs	$ \Delta V/V (1 \text{ mA}) \leq 10\%$ (measured in direction of surge current) No visible damage
Surge current derating, 2 ms	10 surge currents (2ms), unipolar, interval 120s, amplitude corresponding to derating curve for 10 impulses at 2 ms	$ \Delta V/V (1 \text{ mA}) \leq 10\%$ (measured in direction of surge current) No visible damage

Reliability Data Mechanical

Characteristics	Test Methods/Description	Specifications
Tensile strength	IEC 60068-2-21, test Ua1 After gradually applying the force specified below and keeping the unit fixed for 10 s, the terminal shall be visually examined for any damage. Force for wire diameter: 0.6 mm = 10 N 0.8 mm = 10 N 1.0 mm = 20 N	$ \Delta V/V (1 \text{ mA}) \leq 5\%$ No break of solder joint, no wire break
Vibration	IEC 60068-2-6, test Fc, method B4 Frequency range: 10 55 Hz Amplitude: 0.75 mm or 98 m/s ² Duration: 6 h (3 x 2 h) Pulse: sine wave After repeatedly applying a single harmonic vibration according to the table above, the change of V_v shall be measured and the part shall be visually examined.	$ \Delta V/V (1 \text{ mA}) \leq 5\%$ No visible damage
Solderability	IEC 60068-2-20, test Ta, method 1 with modified conditions for lead-free solder alloys: 245°C, 3 s: After dipping the terminals to a depth of approximately 3 mm from the body in a soldering bath of 245 °C for 3 s, the terminals shall be visually examined.	The inspection shall be carried out under adequate light with normal eyesight or with the assistance of a magnifier capable of giving a magnification of 4 to 10 times. The dipped surface shall be covered with a smooth and bright solder coating with no more than small amounts of scattered imperfections such as pinholes or un-wetted or de-wetted areas. These imperfections shall not be concentrated in one area.



Characteristics	Test Methods/Description	Specifications
Resistance to soldering heat	IEC 60068-2-20, test Tb, method 1A, 260 °C, 10 s: Each lead shall be dipped into a solder bath having a temperature of 260 ±5 °C to a point 2.0 to 2.5 mm from the body of the unit, be held there for 10 ±1 s and then be stored at room temperature and normal humidity for 1 to 2 hours. The change of V_v shall be measured and the part shall be visually examined.	$ \Delta V/V (1 \text{ mA}) \leq 5\%$ No visible damage
Bump	IEC 60068-2-29, test Eb Pulse duration: 6 ms Max. acceleration: 400m/s ² Number of bumps: 4000 Pulse: half sine	$ \Delta V/V (1 \text{ mA}) \leq 5\%$ No visible damage
Fire hazard	IEC 60695-11-5 (needle flame test) Severity: vertical 10 s	5 s max.
Electric strength	IEC 61051-1, test 4.9.2 Metal balls method, 2500 V _{RMS} , 60 s The varistor is placed in a container holding 1.6 ±0.2 mm diameter metal balls such that only the terminations of the varistor are protruding. The specified voltage shall be applied between both terminals of the specimen connected together and the electrode inserted between the metal balls.	No breakdown

Reliability Data Environmental

Characteristics	Test Methods/Description	Specifications
Endurance at upper category temperature	1000 h at UCT After having continuously applied the maximum allowable voltage at UCT ± 2 °C for 1000 h, the specimen shall be stored at room temperature and normal humidity for 1 to 2 h. Thereafter, the change of V_v shall be measured.	$ \Delta V/V (1 \text{ mA}) \leq 10\%$
Damp heat, steady state	IEC 60068-2-78, test Ca The specimen shall be subjected to 40 ± 2 °C, 90 to 95 % r.H. for 56 days without load / with 10% of the maximum continuous DC operating voltage V_{DC} . Then stored at room temperature and normal humidity for 1 to 2 h. Thereafter, the change of V_v shall be measured. Thereafter, insulation resistance R_{ins} shall be measured at $V = 500$ V (insulated varistors only).	$ \Delta V/V (1 \text{ mA}) \leq 10\%$ $R_{ins} \geq 100 \text{ M}\Omega$
Climatic sequence	The specimen shall be subjected to: a) IEC 60068-2-2, test Ba, dry heat at UCT, 16 h b) IEC 60068-2-30, test Db, damp heat, 1st cycle: 55 °C, 93% r.H., 24 h c) IEC 60068-2-1, test Aa, cold, LCT, 2 h d) IEC 60068-2-30, test Db, damp heat, additional 5 cycles: 55 °C/25 °C, 93% r.H., 24 h/cycle. Then the specimen shall be stored at room temperature and normal humidity for 1 to 2 h. Thereafter, the change of V_v shall be measured. Thereafter, insulation resistance R_{ins} shall be measured at $V = 500$ V.	$ \Delta V/V (1 \text{ mA}) \leq 10\%$ $R_{ins} \geq 100 \text{ M}\Omega$
Rapid change of temperature	IEC 60068-2-14, test Na, LCT/UCT, dwell time 30 min, 5 cycles	$ \Delta V/V (1 \text{ mA}) \leq 5\%$ No visible damage

Note:

UCT = Upper category temperature

LCT = Lower category temperature

 R_{ins} = Insulation resistance

Cautions and warnings

General

1. EPCOS metal oxide varistors (SIOVs) are designed for specific applications and should not be used for purposes not identified in our specifications, application notes and data books unless otherwise agreed with EPCOS during the design-in-phase.
2. Ensure suitability of SIOVs through reliability testing during the design-in phase. The SIOVs should be evaluated taking into consideration worst-case conditions.
3. For applications of SIOVs in line-to ground circuits based on various international and local standards there are restrictions existing or additional safety measures required.

Storage

1. Store SIOVs only in original packaging. Do not open the package before storage.
2. Storage conditions in original packaging:
Storage temperature: -25 °C ... +45 °C
Relative humidity: <75% annual average,
<95% on maximum 30 days a year.
Dew precipitation: Is to be avoided.
3. Avoid contamination of SIOVs surface during storage, handling and processing.
4. Avoid storage of SIOVs in harmful environments which can affect the function during long-term operation (examples given under operation precautions).
5. The SIOV type series should be soldered within the time specified.
SIOV-S, -Q, -LS 24 months.
ETFV and SFS types 12 months.

Handling

1. SIOVs must not be dropped.
2. Components must not be touched with bare hands. Gloves are recommended.
3. Avoid contamination of the surface of SIOV electrodes during handling, be careful of the sharp edge of SIOV electrodes.

**Soldering (where applicable)**

1. Use rosin-type flux or non-activated flux.
2. Insufficient preheating may cause ceramic cracks.
3. Rapid cooling by dipping in solvent is not recommended.
4. Complete removal of flux is recommended.

Mounting

1. Potting, sealing or adhesive compounds can produce chemical reactions in the SIOV ceramic that will degrade the component's electrical characteristics.
2. Overloading SIOVs may result in ruptured packages and expulsion of hot materials. For this reason the SIOVs should be physically shielded from adjacent components.

Operation

1. Use SIOVs only within the specified temperature operating range
2. Use SIOVs only within the specified voltage and current ranges.
3. Environmental conditions must not harm the SIOVs. Use SIOVs only in normal atmospheric conditions. Avoid use in the presence of deoxidizing gases (chlorine gas, hydrogen sulfide gas, ammonia gas, sulfuric acid gas, etc), corrosive agents, humid or salty conditions, Avoid contact with any liquids and solvents.

Important notes

The following applies to all products named in this publication:

1. Some parts of this publication contain **statements about the suitability of our products for certain areas of application**. These statements are based on our knowledge of typical requirements that are often placed on our products in the areas of application concerned. We nevertheless expressly point out **that such statements cannot be regarded as binding statements about the suitability of our products for a particular customer application**. As a rule, EPCOS is either unfamiliar with individual customer applications or less familiar with them than the customers themselves. For these reasons, it is always ultimately incumbent on the customer to check and decide whether an EPCOS product with the properties described in the product specification is suitable for use in a particular customer application.
2. We also point out that **in individual cases, a malfunction of electronic components or failure before the end of their usual service life cannot be completely ruled out in the current state of the art, even if they are operated as specified**. In customer applications requiring a very high level of operational safety and especially in customer applications in which the malfunction or failure of an electronic component could endanger human life or health (e.g. in accident prevention or life-saving systems), it must therefore be ensured by means of suitable design of the customer application or other action taken by the customer (e.g. installation of protective circuitry or redundancy) that no injury or damage is sustained by third parties in the event of malfunction or failure of an electronic component.
3. **The warnings, cautions and product-specific notes must be observed.**
4. In order to satisfy certain technical requirements, **some of the products described in this publication may contain substances subject to restrictions in certain jurisdictions (e.g. because they are classed as hazardous)**. Useful information on this will be found in our Material Data Sheets on the Internet (www.epcos.com/material). Should you have any more detailed questions, please contact our sales offices.
5. We constantly strive to improve our products. Consequently, **the products described in this publication may change from time to time**. The same is true of the corresponding product specifications. Please check therefore to what extent product descriptions and specifications contained in this publication are still applicable before or when you place an order. We also **reserve the right to discontinue production and delivery of products**. Consequently, we cannot guarantee that all products named in this publication will always be available. The aforementioned does not apply in the case of individual agreements deviating from the foregoing for customer-specific products.
6. Unless otherwise agreed in individual contracts, **all orders are subject to the current version of the "General Terms of Delivery for Products and Services in the Electrical Industry" published by the German Electrical and Electronics Industry Association (ZVEI)**.
7. The trade names EPCOS, BAOKE, Alu-X, CeraDiode, CeraLink, CeraPlas, CSMP, CSSP, CTVS, DeltaCap, DigiSiMic, DSSP, FilterCap, FormFit, MiniBlue, MiniCell, MKD, MKK, MLSC, MotorCap, PCC, PhaseCap, PhaseCube, PhaseMod, PhiCap, SIFERRIT, SIFI, SIKOREL, SilverCap, SIMDAD, SiMic, SIMID, SineFormer, SIOV, SIP5D, SIP5K, ThermoFuse, WindCap are **trademarks registered or pending** in Europe and in other countries. Further information will be found on the Internet at www.epcos.com/trademarks.