

# Surge Protection and Power Supply Units

## 2013 / 2014

# 6





## 1 PCB connection technology and electronics housing

- PCB terminal blocks and plug-in connectors
- Electronics housing



## 2 Connection technology for field devices

- Plug-in connectors
- Cables and connectors



## 3 Modular terminal blocks

- Modular terminal blocks



## 4 Sensor/actuator cabling and industrial plug-in connectors

- Sensor/actuator cabling
- Cables and connectors
- Plug-in connectors



## 5 Marking systems, tools, and mounting material

- Marking and labeling
- Tools
- Installation and mounting material



## 6 Surge protection and power supply units



## 7 Interface technology and switching devices

- Electronic switching devices and motor control
- Measurement and control technology • Monitoring
- Relay modules • System cabling for controllers



## 8 Control technology, I/O systems and automation infrastructure

- Ethernet networks • Functional safety • HMIs and industrial PCs • I/O systems
- Industrial lighting and signaling • Industrial communication technology
- Fieldbus components and systems • Wireless data communication
- Process infrastructure • Software • Controllers

# Table of contents

---

## Overview

The table of contents will help you find the right product more quickly

2

---

## Lightning monitoring system



5

---

## Surge protection and interference filters



11

---

## Power supply units and UPS



159

---

## Protective devices



251

---

## Technical information

276

---

## Index

290

# Introduction

## Product range overview

### Lightning current measuring system



LM-S Page 8

### Surge protection for the power supply



**Type 1 lightning arrester**  
FLASHTRAB Page 28  
POWERTRAB Page 32  
VALVETRAB T1/T2 Page 34



**Type 1 + 2 lightning and surge arrester combination**  
FLASHTRAB compact Page 36



**Type 2 surge arrester**  
VALVETRAB compact Page 40  
VALVETRAB MS Page 42  
Combination arrester Page 52

### Set solutions



Type 3 device protection Page 56



Building set Page 65



Arrester for PV systems Page 64  
Box solution for PV systems Page 66



Box solution for the American market Page 68

### Surge protection for measurement and control technology



**DIN rail modules**  
PLUGTRAB Page 72  
LINETRAB Page 90  
TERMITRAB Page 94



Special systems Page 100  
LSA-PLUS modules Page 102

### Surge protection for information technology



For networks Page 114  
For interfaces Page 116



Telecommunications systems Page 126

### Surge protection for transceiver systems



For mobile phone networks Page 136  
For video communication Page 140



For radio and television sets Page 142

### EMC solutions



Mains interference filters with integrated surge protection Page 146  
Interference filters Page 148

### Testers



CHECKMASTER Page 152  
Test adapters Page 152

Power supply units



QUINT POWER Page 166



TRIO POWER Page 174



MINI POWER Page 180



UNO POWER Page 184



STEP POWER Page 186



QUINT POWER, dip-coated Page 194



QUINT DC/DC converters Page 198  
MINI DC/DC converter Page 202



QUINT ORING Page 206  
TRIO DIODE Page 208  
QUINT DIODE Page 210  
STEP DIODE Page 210

DC/DC converters

Redundancy modules

UPS for the control cabinet



QUINT UPS-IQ Page 218



Power storage for  
QUINT UPS-IQ Page 222



UPS with integrated power storage  
QUINT UPS Page 230  
QUINT BUFFER Page 231  
STEP UPS Page 232



UPS with integrated power supply unit  
TRIO UPS Page 234  
MINI UPS Page 235

UPS for 19" rack/tower

Protective devices



UPS devices Page 244



Battery modules Page 246  
Accessories Page 248



CB device circuit breakers Page 256  
Circuit breaker Page 263



TCP thermal circuit breakers Page 264  
Fuse terminal blocks, see Catalog 3



# LM-S lightning monitoring system

Lightning strikes are a particular hazard for exposed structures such as offshore wind parks, radio masts, leisure facilities or high buildings.

The LM-S lightning current measuring system can detect, evaluate, and remotely monitor lightning strikes in realtime. This means that information about the actual load on the system from lightning strikes is available at all times. The findings obtained regarding the load on a system enable optimized maintenance planning.

## Lightning monitoring system

---

<b>Introduction</b>	<b>6</b>
---------------------	----------

---

### LM-S

Sensor	8
Connecting cable	8
Evaluation unit	9
Optoelectronic module	9



Lightning strikes cause devastating damage to buildings and systems. It is practically impossible for employees to continuously monitor exposed or large-scale systems, which means that damage is detected too late.

### Detecting lightning with the lightning monitoring system

The LM-S lightning monitoring system supports continuous monitoring. Lightning events are detected, evaluated, and remotely monitored via network access. This means that information about the actual load on the system from lightning strikes is available at all times. The findings obtained regarding the load on a system enable optimized maintenance planning.

The LM-S lightning current measuring system consists of the following components:

- Sensor
- Connecting cable
- O/E module
- Evaluation unit



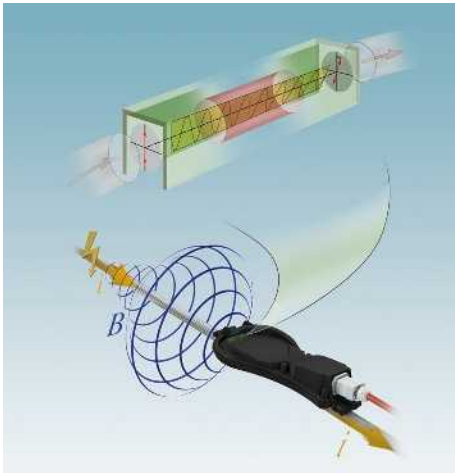

### Faraday effect as a reliable measuring method

The internal measuring principle of the LM-S is based on the Faraday effect. Polarized light in a specific medium is rotated through a magnetic field over a defined length and measured.

The higher the amperage ( $i$ ) generated by a lightning strike the greater the magnetic flux density ( $B$ ) and, therefore, the rotation of the polarized light.

The lightning monitoring system detects this change in the light signal and uses this as the basis for the corresponding measured value results.

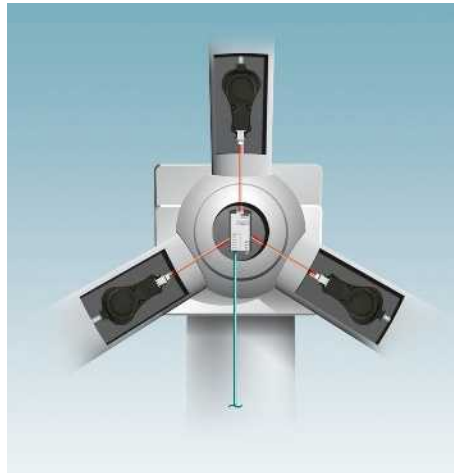

### Detection and evaluation

The sensors are mounted on the lightning arrester cables. They record the magnetic field that occurs around the conductor due to the lightning surge current. The measured result is transmitted via fiber optics to the O/E module of the evaluation unit, where the optical signal is converted into an electrical signal. Based on the values obtained, the evaluation unit determines the lightning characteristics with their typical parameters, including, for example, the maximum lightning current strength, lightning current rate of rise, charge, and energy. These results can be forwarded to an available management system via the Ethernet interface.



### Remote monitoring in realtime

The evaluation unit can be easily integrated into standard network systems via the RJ45 Ethernet interface. An internal web server is used as the basis for accessing recorded data and configuring the system. The web interface is opened via the Internet browser of a PC connected to the system using IP addressing.

# Lightning current measuring system

## LM-S

### Sensor

- Optical lightning sensor for measuring current strength of lightning surge currents
- Subsequent mounting is possible
- Rugged design
- Resistant to vibrations, temperature, and humidity
- Good UV resistance
- Good oil resistance



Sensor

Detectable values	
Maximum current strength	250 kA
FO interface	
Connection method	SCRJ socket with push/pull connector, IP67
General data	
Ambient temperature (operation)	-30 °C ... 60 °C
Ambient temperature (storage/transport)	-40 °C ... 85 °C
Degree of protection	IP67

### Technical data

Detectable values	
Maximum current strength	250 kA
FO interface	
Connection method	SCRJ socket with push/pull connector, IP67
General data	
Ambient temperature (operation)	-30 °C ... 60 °C
Ambient temperature (storage/transport)	-40 °C ... 85 °C
Degree of protection	IP67

Description	Sensor	
-------------	--------	--

### Ordering data

Type	Order No.	Pcs. / Pkt.
LM-S-LS-H	2800616	1

### Connecting cable

- HCS cable for connecting LM-S sensors to the O/E module
- Robust cable for use in harsh environments
- Good UV resistance
- Good oil resistance

**Notes:**  
The specified plug configuration (see ordering example) must be used in order to use the connecting cable in the LM-S lightning monitoring system. Recommended length: 10 to 200 m



Connecting cable for LM-S

### Ordering example for LM-S connecting cable with variable cable length:

Assembled connecting cable for the LM-S lightning monitoring system, with a metal push/pull plug-in connector, a B-FOC plug, and a cable length of 10 m.

Order No.	Length [m] Max. 200 m
1408480 / FOC-HCS-BFOC/1018B/PPCME	10.0
Increments: 10.0 m ... 200 m = 1.0 m	

General data	
Ambient temperature (operation)	-40°C ... 70°C
Ambient temperature (storage/transport)	-40°C ... 70°C
Degree of protection	IP20 (B-FOC)/IP67 (PPCME)

### Technical data

General data	
Ambient temperature (operation)	-40°C ... 70°C
Ambient temperature (storage/transport)	-40°C ... 70°C
Degree of protection	IP20 (B-FOC)/IP67 (PPCME)

Description	Connecting cable Variable	
-------------	---------------------------	--

### Ordering data

Type	Order No.	Pcs. / Pkt.
FOC-HCS-BFOC/1018B/PPCME/...	1408480	1

## Evaluation unit

- Complete module including O/E module for connecting up to three LM-S sensors
- Evaluation and storage of amperage, current increase rate, charge, and specific energy
- Realtime analysis and exact time allocation
- Status and diagnostic indicators
- Communication via Ethernet
- Operation and configuration via web interface
- Mounting on a DIN rail



Evaluation unit with O/E module

Technical data	
Supply voltage	24 V DC $\pm$ 4 V
Ethernet interfaces	
Connection method	RJ45
Transmission speed	10/100 Mbps
FO interface	
Interface	B-FOC (ST®)
Number of ports	3
Sensor interfaces	
Connection method	Rack for plug-in I/O module
Remote indication contact	
Connection method	M12 D-coded
Max. operating voltage	- / 60 V DC
General data	
Ambient temperature (operation)	-30 °C ... 60 °C
Degree of protection	IP20

Ordering data		
Type	Order No.	Pcs. / Pkt.
LM-S-A/C-3S-ETH	2800618	1

Description
Evaluation unit with O/E module

## Optoelectronic module

- O/E module replacement for evaluation unit
- Connection of up to three LM-S sensors
- Status and diagnostic display via evaluation unit



O/E module

Technical data	
FO interface	
Interface	B-FOC (ST®)
Number of ports	3
General data	
Ambient temperature (operation)	-40 °C ... 60 °C
Ambient temperature (storage/transport)	-40 °C ... 85 °C
Degree of protection	IP20

Ordering data		
Type	Order No.	Pcs. / Pkt.
LM-S-C-3LS	2800617	1

Description
Optoelectronic module



# Surge protection and interference filters

## Damage caused by surge voltages

The number of electrical devices damaged or destroyed by surge voltages is increasing year on year. This can prove expensive in terms of repairs and downtimes. In an industrial environment, the hazards are not only restricted to systems and devices. Building technology applications and even residential buildings may be affected.

## Interference voltages

Switching operations triggered mechanically or electronically generate pulse-like and high-frequency interference voltages. These voltages spread in an unimpeded manner across the cable network. All the devices within this cable network are affected. Data errors, uncontrolled functions, and system crashes can result, with electronic and data processing devices at particular risk.

<b>Selection guides and applications</b>	<b>12</b>
<hr/>	
<b>Surge protection for the power supply</b>	<b>26</b>
Type 1 lightning arresters	28
Type 1 + 2 lightning/surge arrester combinations	36
Type 2 surge arresters	40
Industry solutions	50
Type 2 combined solutions	52
Type 3 device protection	56
<hr/>	
<b>Renewable energy sources</b>	<b>64</b>
<hr/>	
<b>Set solutions</b>	<b>65</b>
<hr/>	
<b>Surge protection for measurement and control technology</b>	<b>70</b>
DIN rail modules	72
- PLUGTRAB PT-IQ	
- MCR-PLUGTRAB	
- LINETRAB	
- TERMITRAB	
Special systems	100
- SURGETRAB	
Modules for LSA-PLUS technology	102
- COMTRAB modular	
- COMTRAB	
<hr/>	
<b>Surge protection for information technology</b>	<b>112</b>
Bus systems	114
Telecommunications	126
<hr/>	
<b>Surge protection for transceiver systems</b>	<b>134</b>
Transceiver technology	136
TV and radio systems	140
<hr/>	
<b>Interference filters</b>	<b>144</b>
Filters with type 3 surge protection	146
Filters	149
<hr/>	
<b>Test device for arresters</b>	<b>150</b>
<hr/>	
<b>Approvals</b>	<b>154</b>

# Surge protection and interference filters

## Selection guide and applications

### General information on the application drawings below

- The example illustrations are intended to help you select the right surge protection. They make no claim to be complete with regard to the prescribed safety measures.
- The illustrated connection diagrams do not replace standard-compliant planning of a protection concept by an electrical or lightning protection specialist.
- The fixed electrical installation may only be accessed by trained specialist personnel.
- In order to ensure the correct and appropriate use of products, the relevant installation notes must be observed prior to installation or startup.
- All information/notes can be downloaded under the relevant product documentation at [www.phoenixcontact.net/products](http://www.phoenixcontact.net/products).

Distinguishing features of the protective devices for the power supply					
	Type 1	Type 1+2	Type 1/2	Type 2	Type 3
Lightning protection zone transition	0-1	0-2	0-1/1-2	1-2	2-3
Without detailed calculation of the lightning surge current at the installation location can be used at Lightning Protection Level	I - IV	I - IV	III - IV		
Type 1 and type 2 combined in a single device Can be used universally		☑			

### Three-stage protection for the power supply, type 1 and type 2 installed separately + type 3

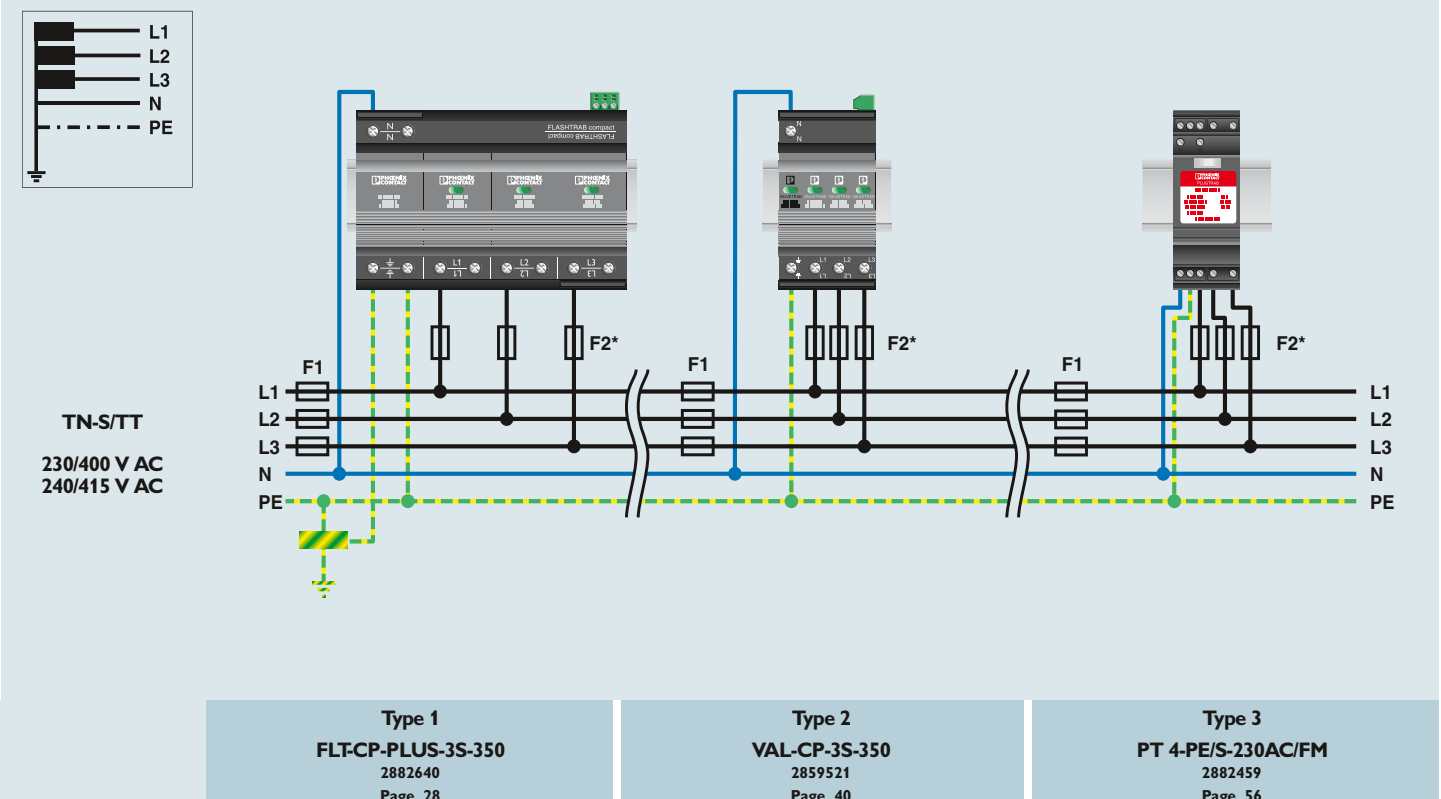

\* F2 is not needed if  $F1 \leq$  maximum backup fuse according to IEC

### Two-stage protection for the power supply, type 1/2 combination based on varistor + type 3

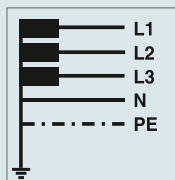

TN-S/TT  
 230/400 V AC  
 240/415 V AC

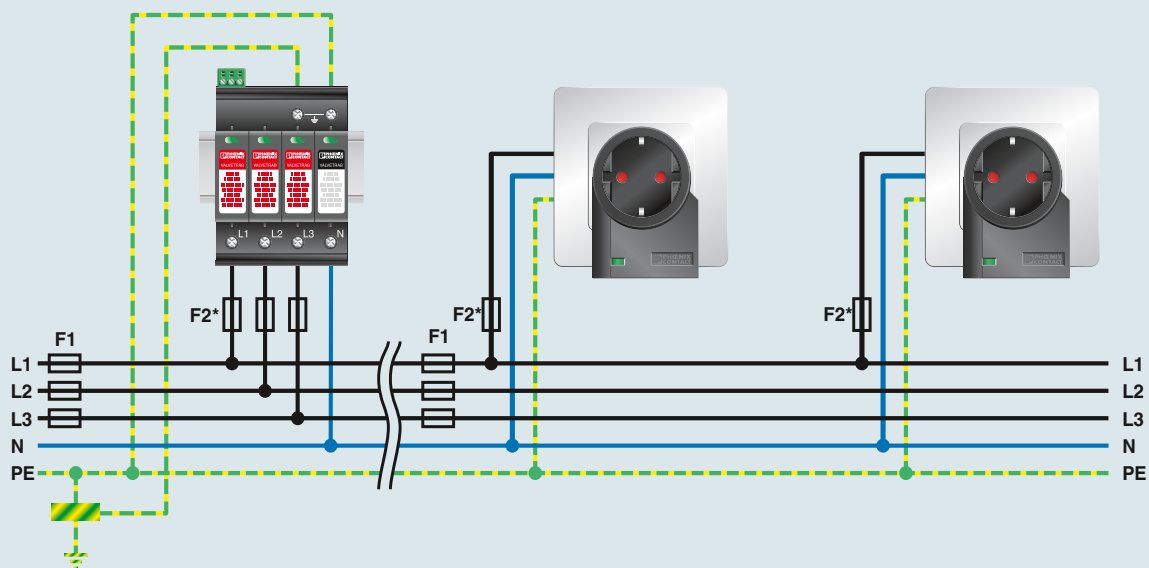

**Type 1/2**  
**VAL-MS-T1/T2 335/12.5/3+1-FM**  
 2800183  
 Page 34

**Type 3**  
**MNT-1 D**  
 2882200  
 Page 60

### Three-stage protection for the power supply, type 1 and type 2 installed separately + type 3

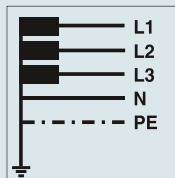

TN-S/TT  
 230/400 V AC  
 240/415 V AC

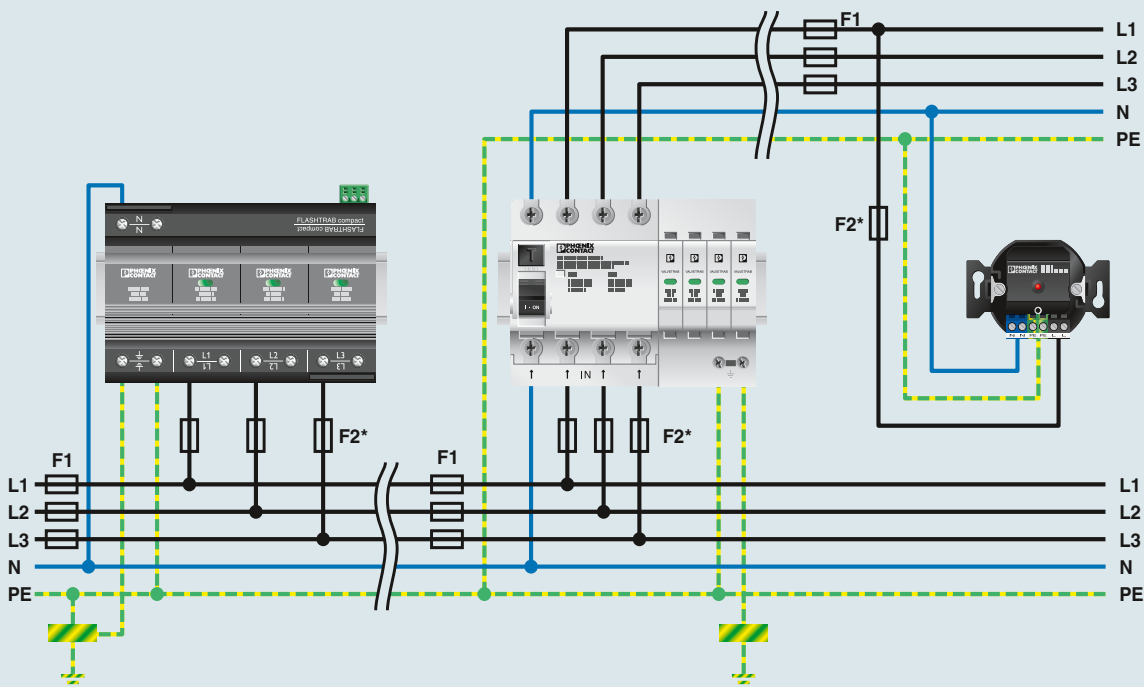

**Type 1**  
**FLT-CP-PLUS-3S-350**  
 2882640  
 Page 28

**Type 2**  
**VAL-CP-RCD-3S/40/0.3/SEL**  
 2808001  
 Page 52

**Type 3**  
**PRT-CD-AD1 + PRT-S-230/FM**  
 2749673 + 2749686  
 Page 58

\* F2 is not needed if  $F1 \leq$  maximum backup fuse according to IEC

# Surge protection and interference filters

## Selection guide and applications

### Three-stage protection for the power supply, type 1 and type 2 installed separately + type 3

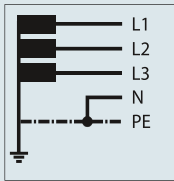

**TN-C-S**  
230/400 V AC  
240/415 V AC

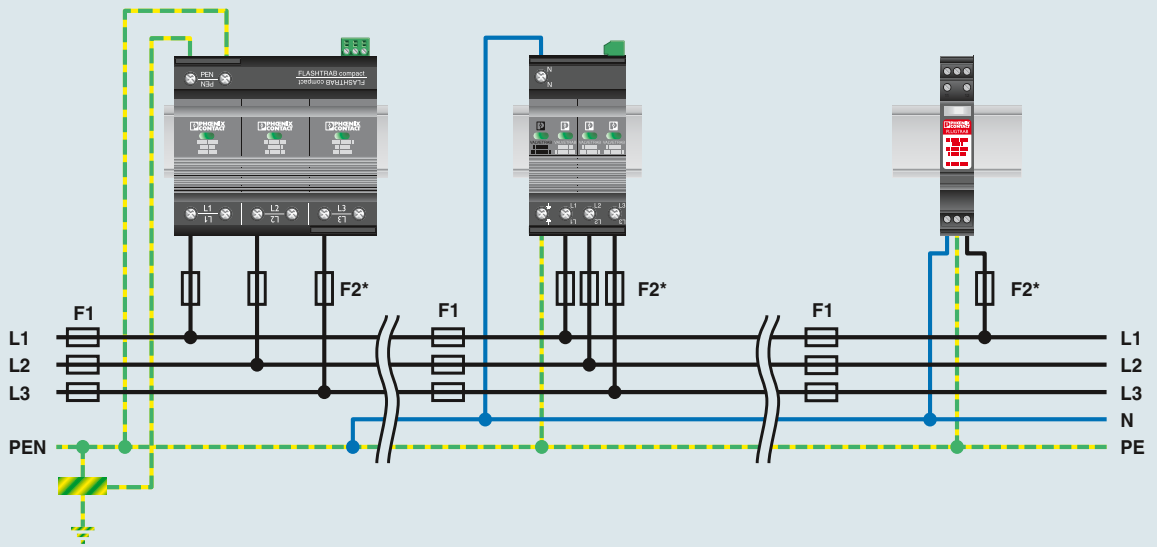

**Type 1**  
**FLT-CP-PLUS-3C-350**  
2882653  
Page 28

**Type 2**  
**VAL-CP-3S-350**  
2859521  
Page 40

**Type 3**  
**PT 2-PE/S-230AC/FM**  
2858357  
Page 56

### Two-stage protection for the power supply, type 1/2 combination based on varistor + type 3

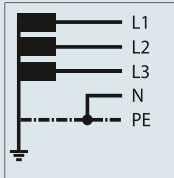

**TN-C-S**  
230/400 V AC  
240/415 V AC

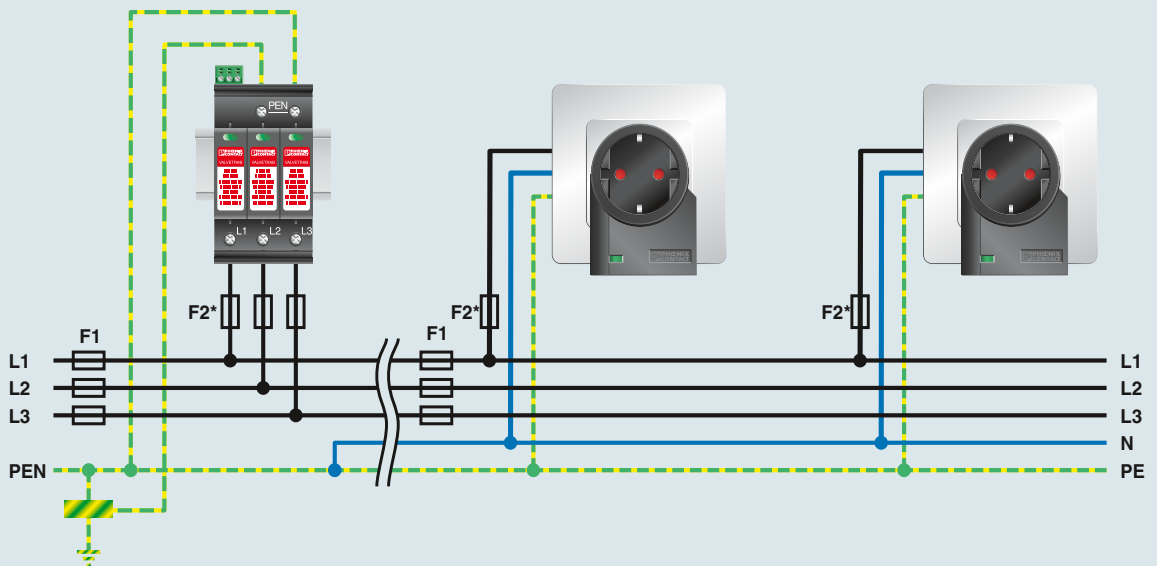

**Type 1/2**  
**VAL-MS-T1/T2 335/12.5/3+0-FM**  
2800188  
Page 34

**Type 3**  
**MNT-1 D**  
2882200  
Page 60

\* F2 is not needed if  $F1 \leq$  maximum backup fuse according to IEC



### Three-stage protection for the power supply, type 1 and type 2 combined in a single device + type 3

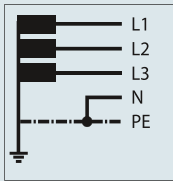

**TN-C-S**  
230/400 V AC  
240/415 V AC

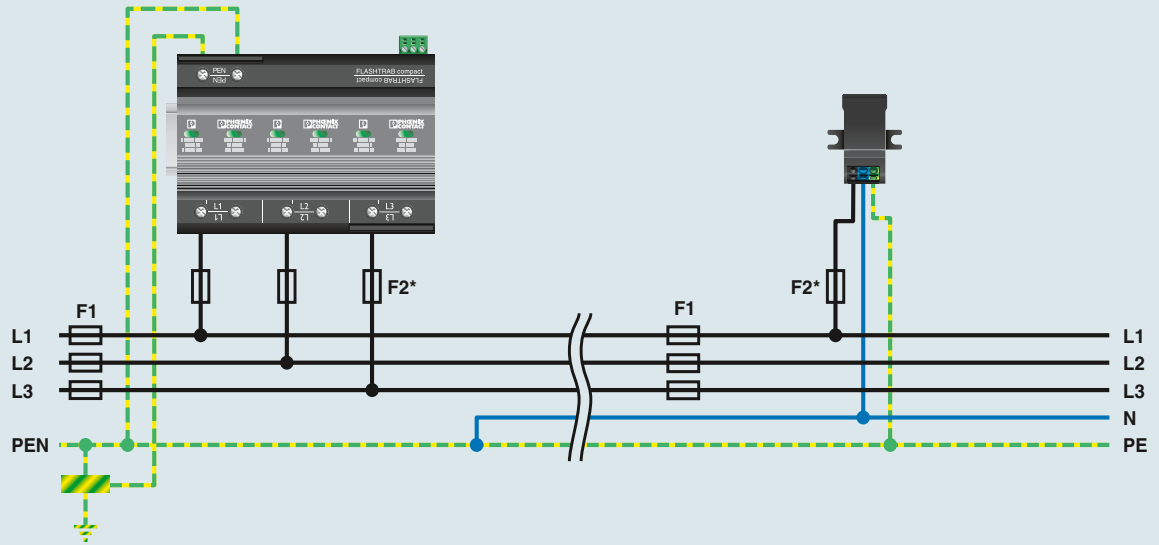

**Type 1+2**  
**FLT-CP-3C-350**  
2859725  
Page 36

**Type 3**  
**BT-1S-230AC/A**  
2803409  
Page 58

\* F2 is not needed if  $F1 \leq$  maximum backup fuse according to IEC

# Surge protection and interference filters

## Selection guide and applications

### Two-stage protection for the power supply, type 1 and type 2 installed separately

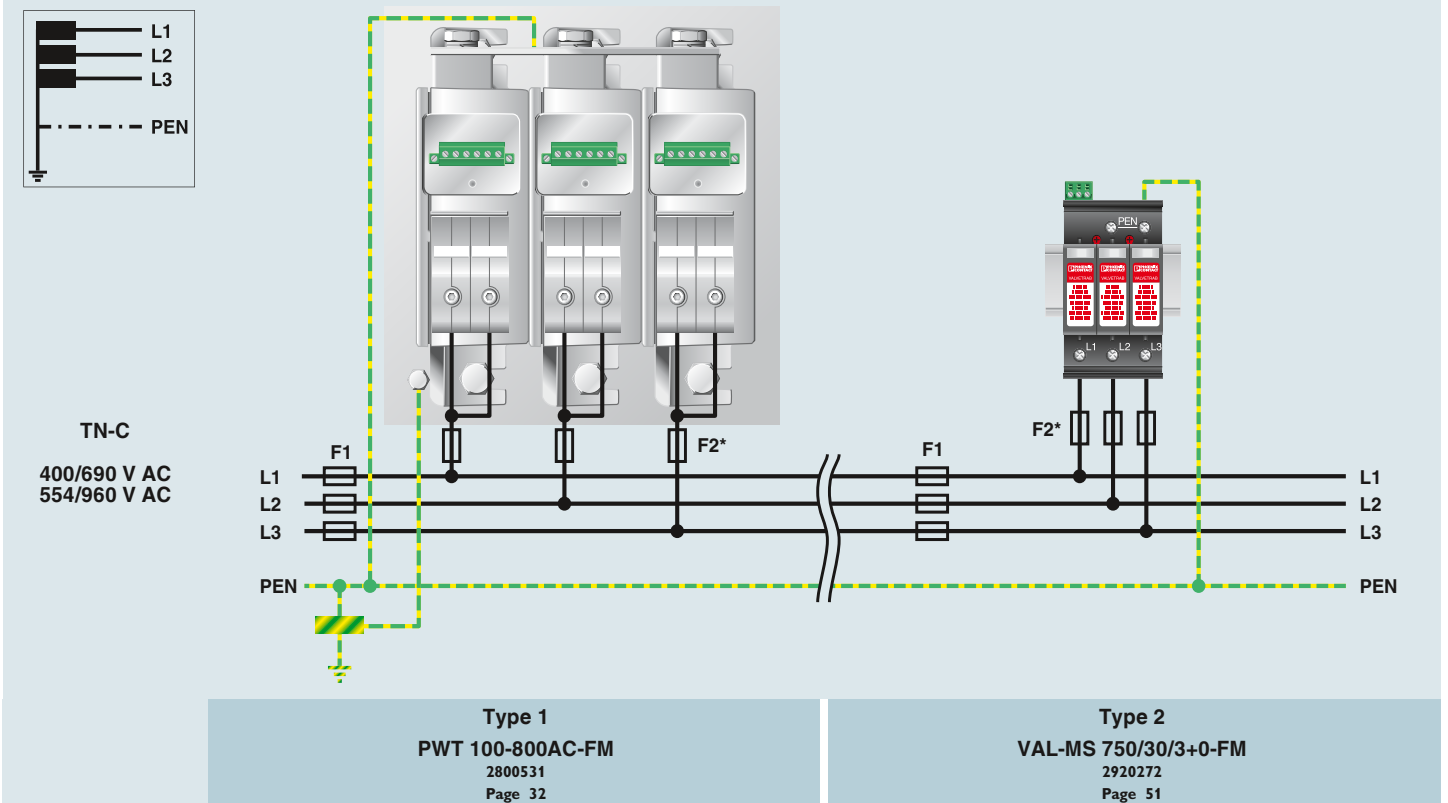

\* F2 is not needed if  $F1 \leq$  maximum backup fuse according to IEC

### Two-stage protection for the power supply, type 1 and type 2 installed separately

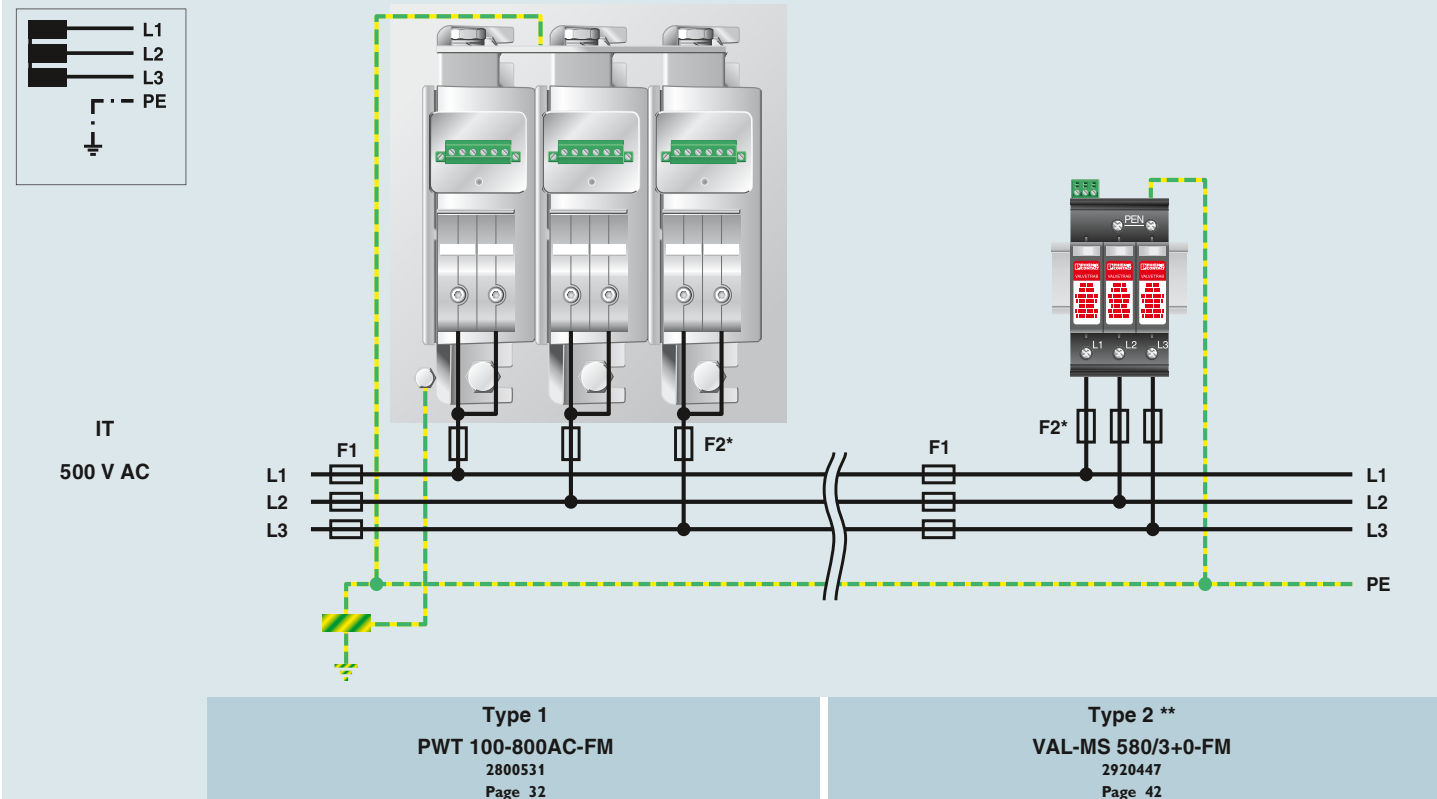

### Two-stage protection for the power supply, type 1 and type 2 installed separately

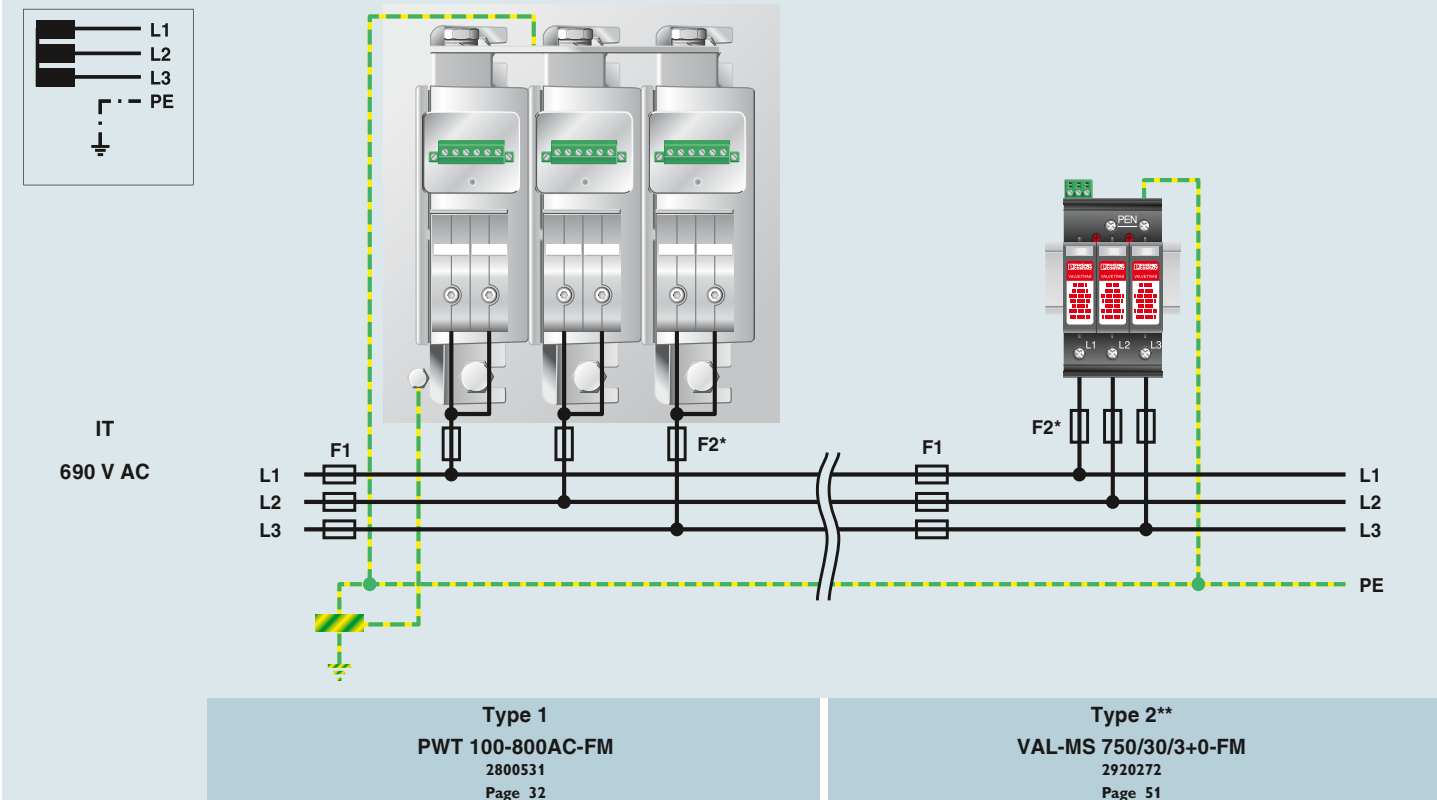

\* F2 is not needed if  $F1 \leq$  maximum backup fuse according to IEC  
 \*\* Application only in IT systems supplied with a low voltage

# Surge protection and interference filters

## Selection guide and applications

### Protection of a binary signal input with actuator circuit, floating reference potential

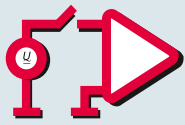

E.g.,  
24 V switched

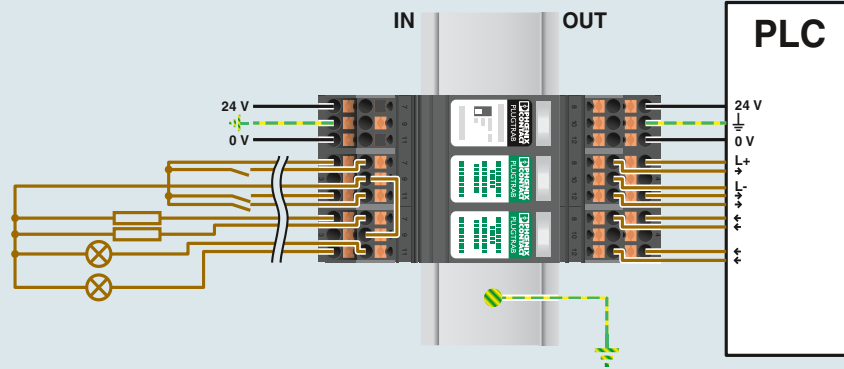

Plug-in

Push-in connection

1 x PT-IQ-PTB-PT +  
2 x PT-IQ-4X1+F-24DC-PT  
2801296 + 2801272  
Page 74

Optional screw connection

1 x PT-IQ-PTB-UT +  
2 x PT-IQ-4X1+F-24DC-UT  
2800768 + 2800983  
Page 72

### Protection of a binary signal input with actuator circuit, grounded reference potential

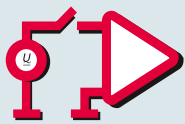

E.g.,  
24 V switched

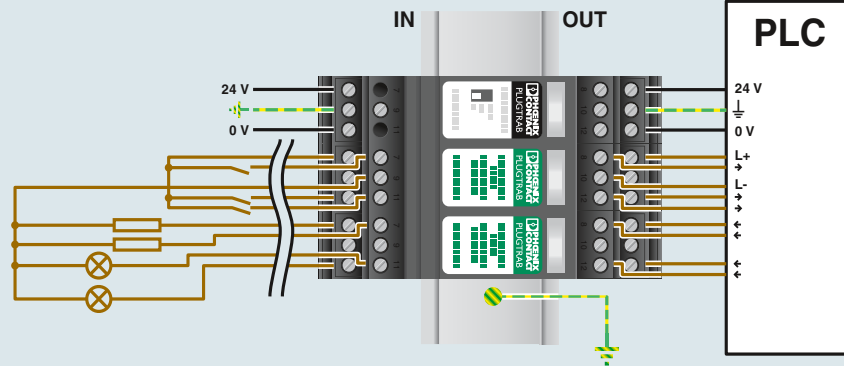

Plug-in

Screw connection

1 x PT-IQ-PTB-UT +  
2 x PT-IQ-4X1-24DC-UT  
2800768 + 2800982  
Page 72

Optional push-in connection

1 x PT-IQ-PTB-PT +  
2 x PT-IQ-4X1-24DC-PT  
2801296 + 2801271  
Page 74

### Protection of a binary signal input with actuator circuit, common grounded reference potential (negative pole)

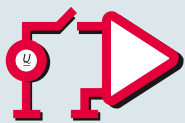

E.g.,  
24 V switched

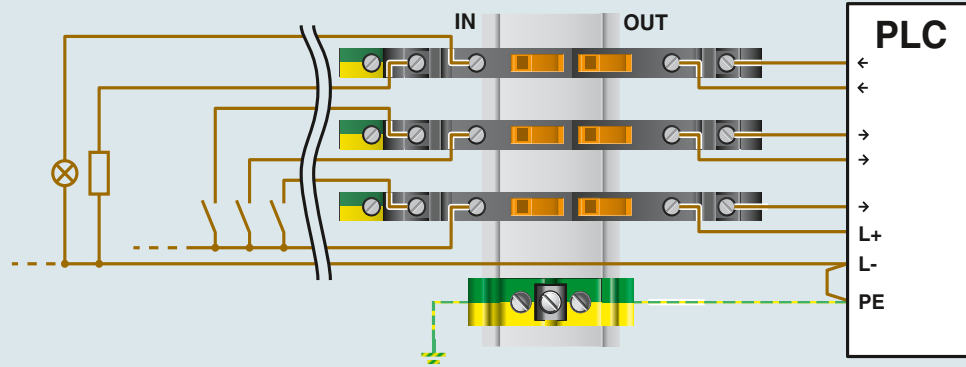

One-piece

Screw connection

TT-2/2-M-24DC  
2920722  
Page 94

Optional  
spring-cage connection

TT-STM-2/2-24DC  
2858917  
Page 96

**Protection of a binary signal input with actuator circuit, common floating reference potential (negative pole)**

**One-piece**

Spring-cage connection	<b>TT-ST-M-2/2-24DC</b> 2858917 Page 96	Optional screw connection	<b>TT-2/2-M-24DC</b> 2920722 Page 94
------------------------	---	---------------------------	--

E.g., 24 V switched

**Protection of a four-conductor measurement**

**Plug-in**

<b>PT 4-24DC-ST + PT 4-BE</b> 2839240 + 2839402 Page 84	<b>PT 4-24DC-ST + PT 4-BE</b> 2839240 + 2839402 Page 84
---	---

E.g., temperature measurement

**Protection of a four-conductor measurement, for Ex and non-Ex applications**

**One-piece**

<b>LIT 4-24</b> 2804678 Page 92	<b>LIT 4-24</b> 2804678 Page 92
---------------------------------------	---------------------------------------

E.g., temperature measurement

# Surge protection and interference filters

## Selection guide and applications

### Protection of an analog measurement

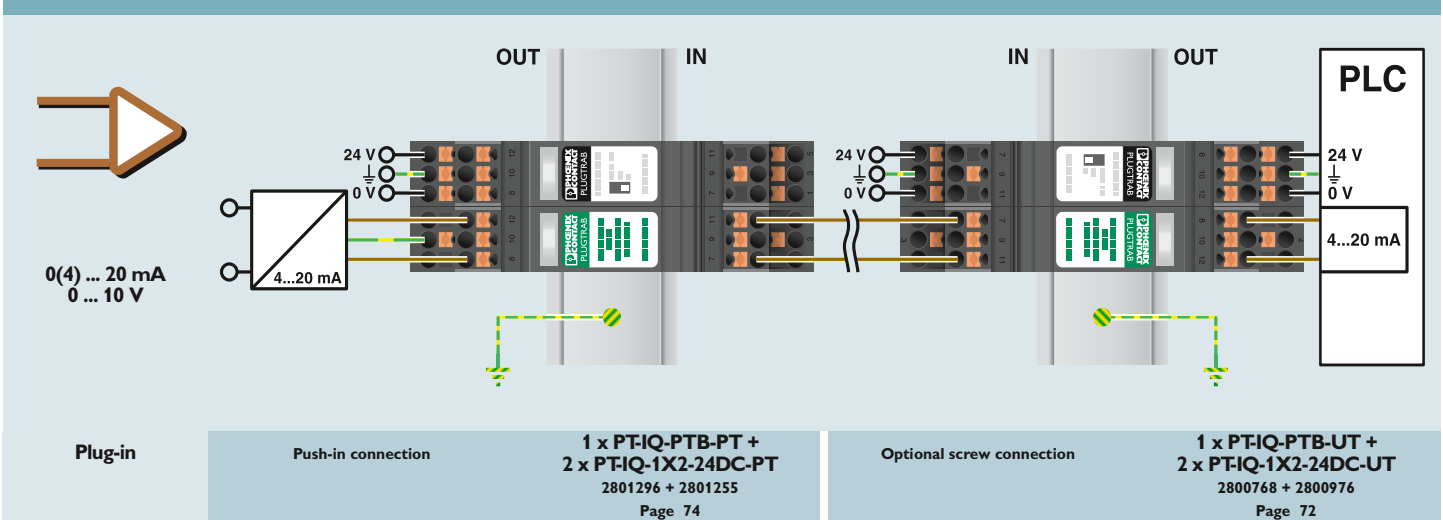

### Protection of an analog measurement

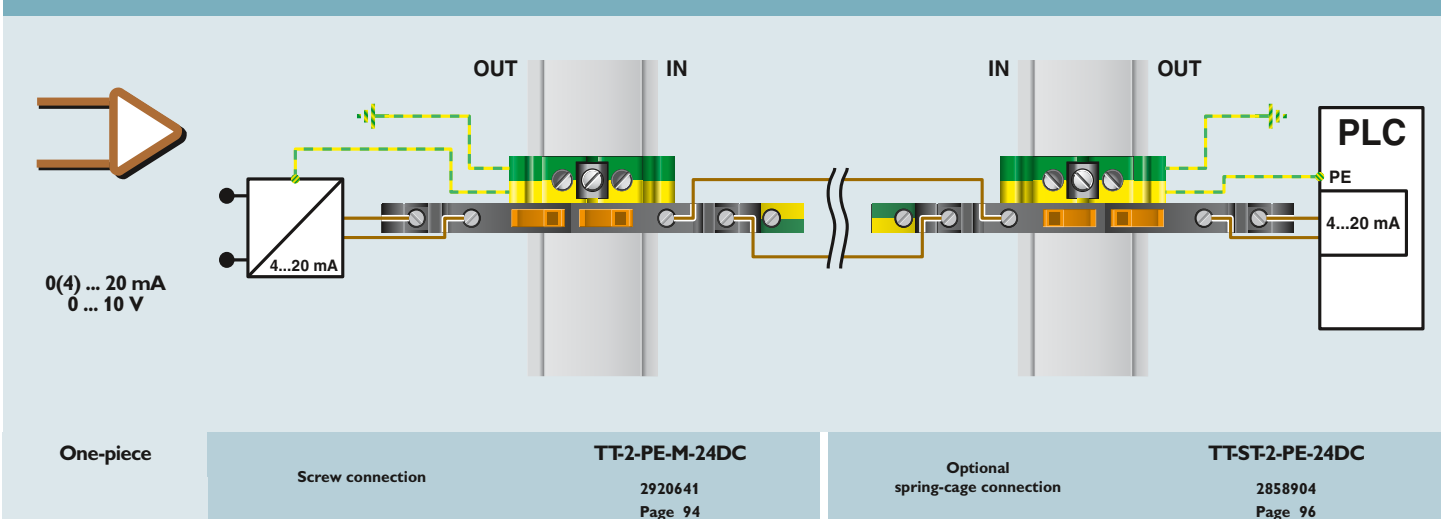

### Protection of an analog measurement, intrinsically safe circuits

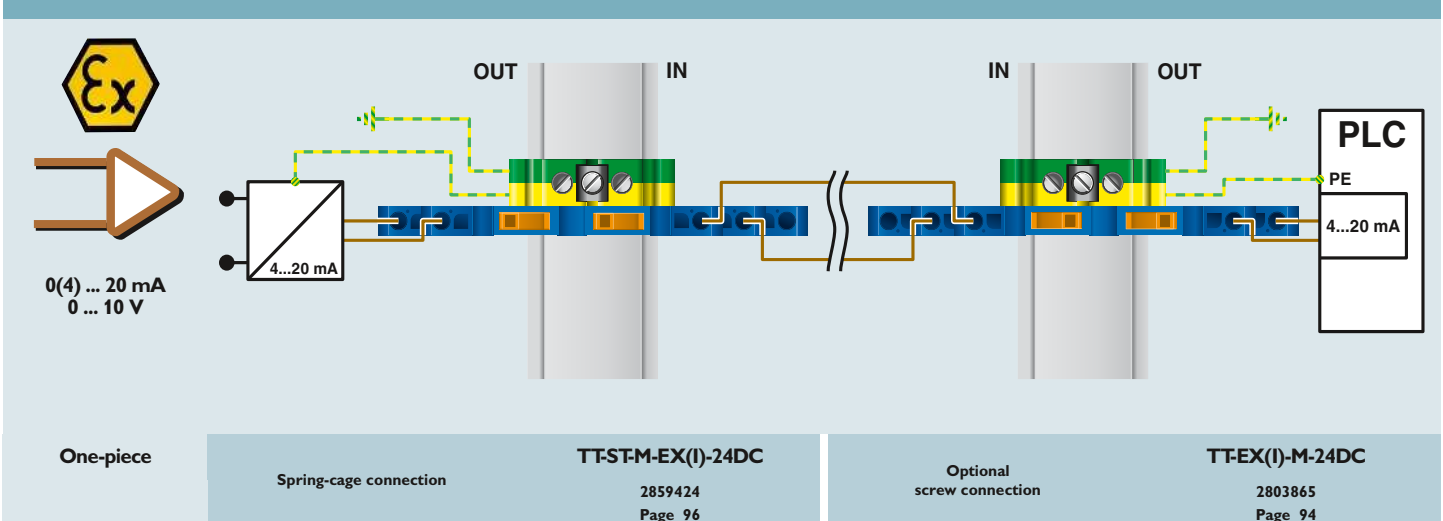

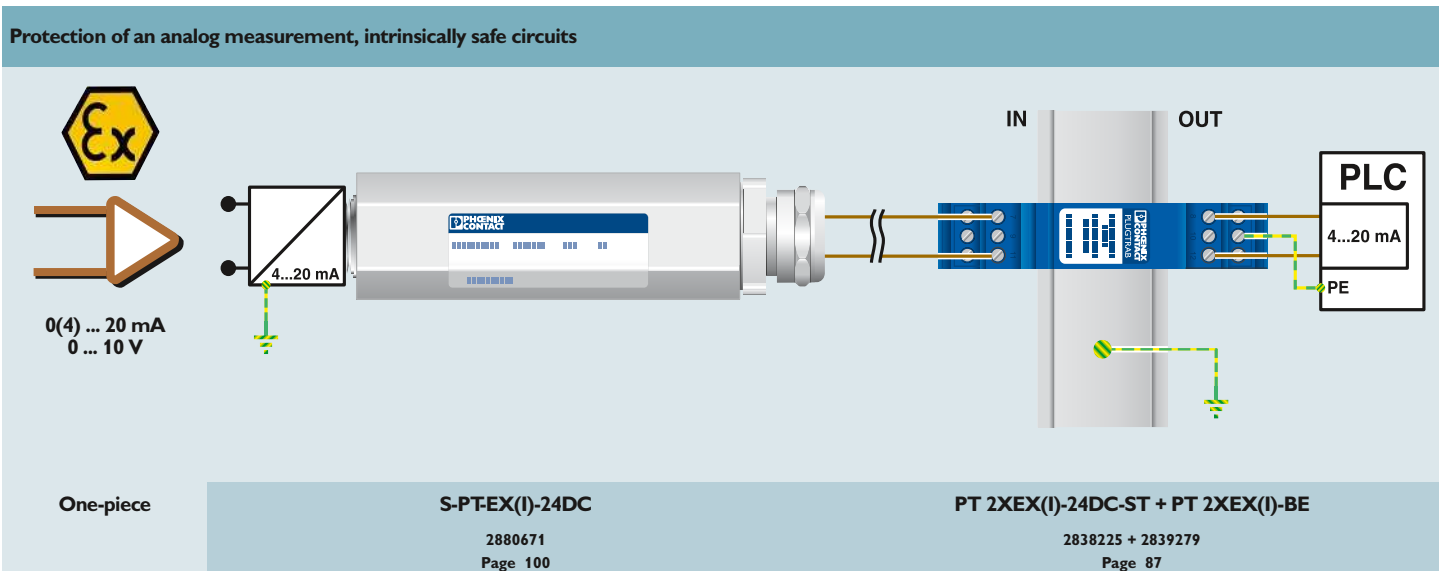
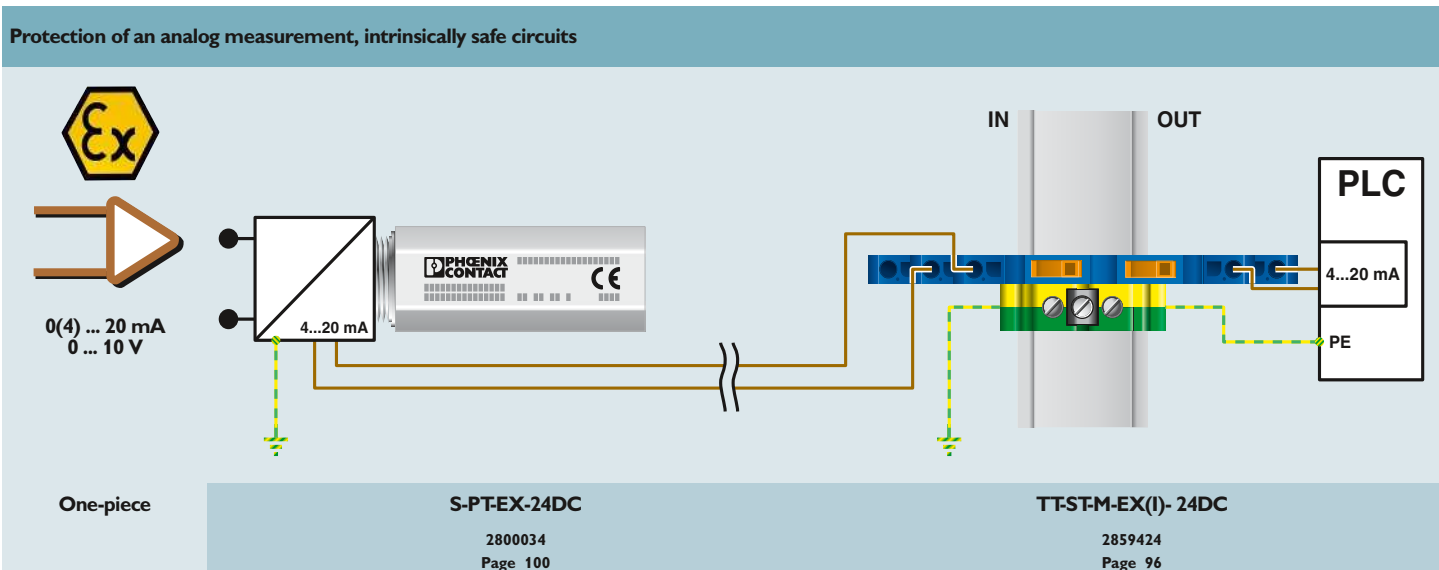
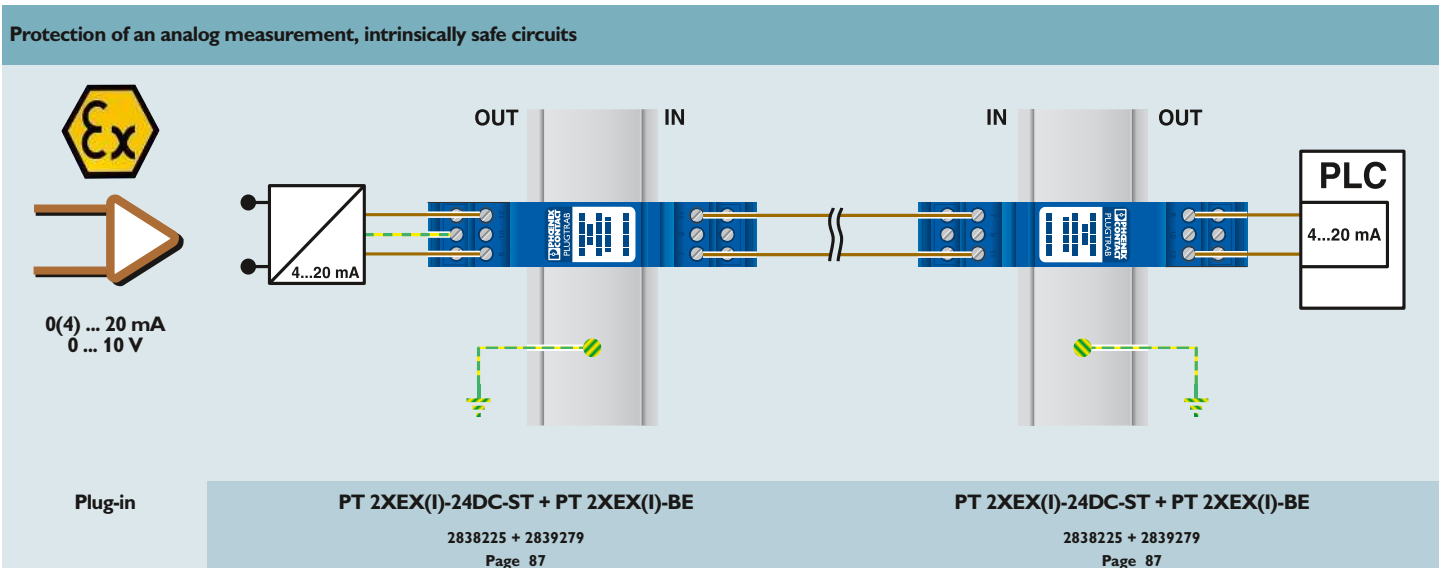

# Surge protection and interference filters

## Selection guide and applications

### Protection of PROFIBUS DP

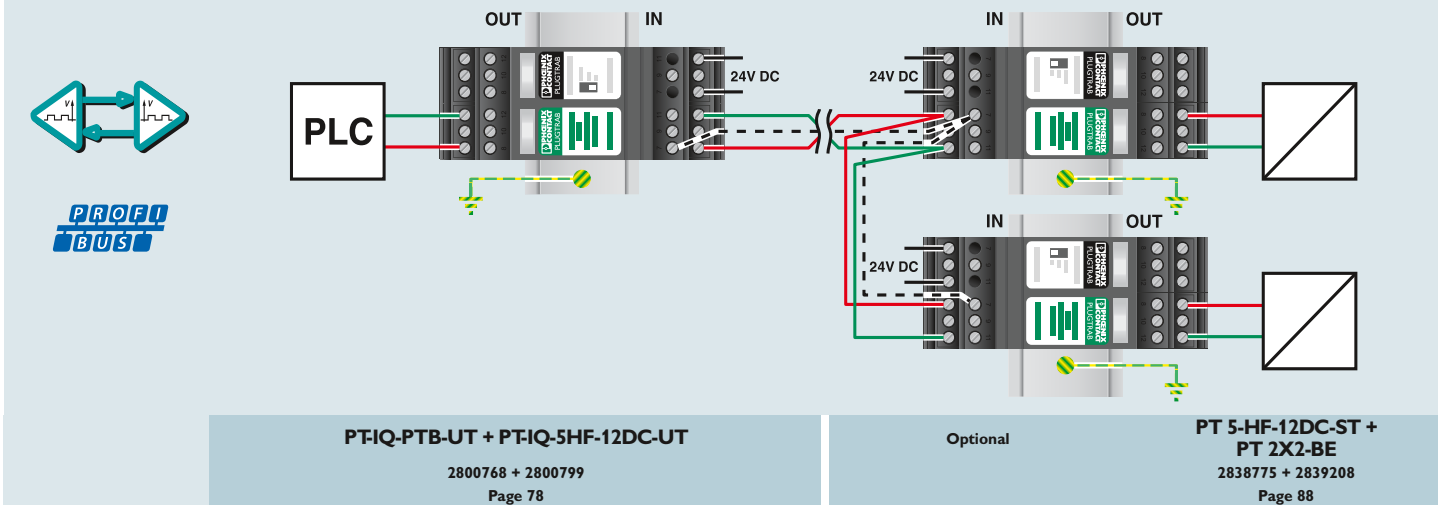

### Protection of PROFIBUS PA

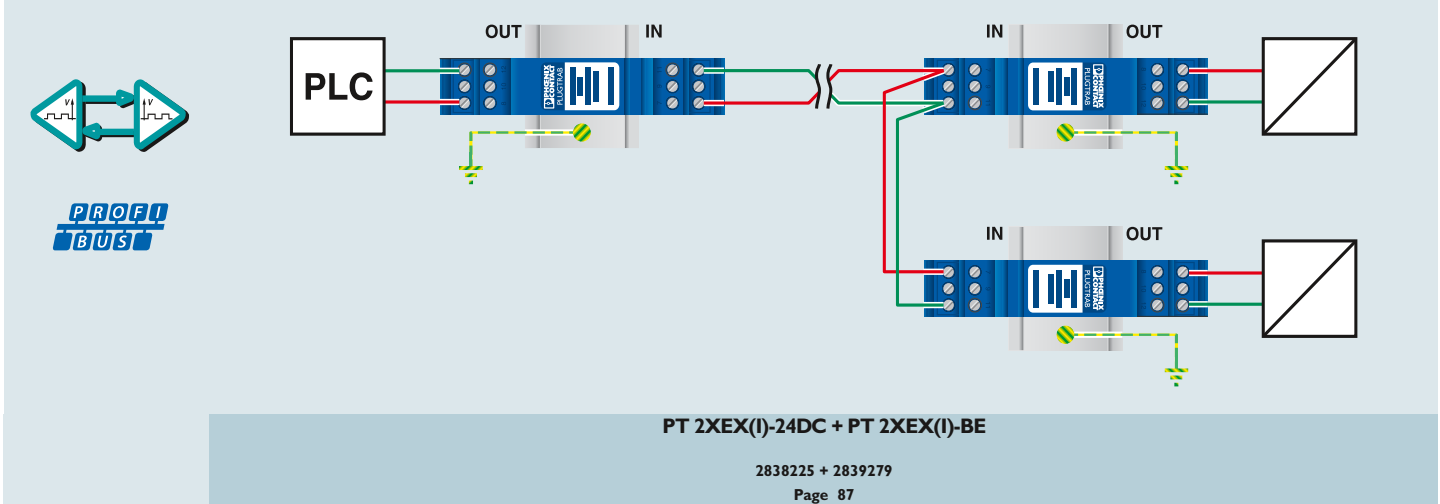

### Protection of CAN bus/DeviceNet™

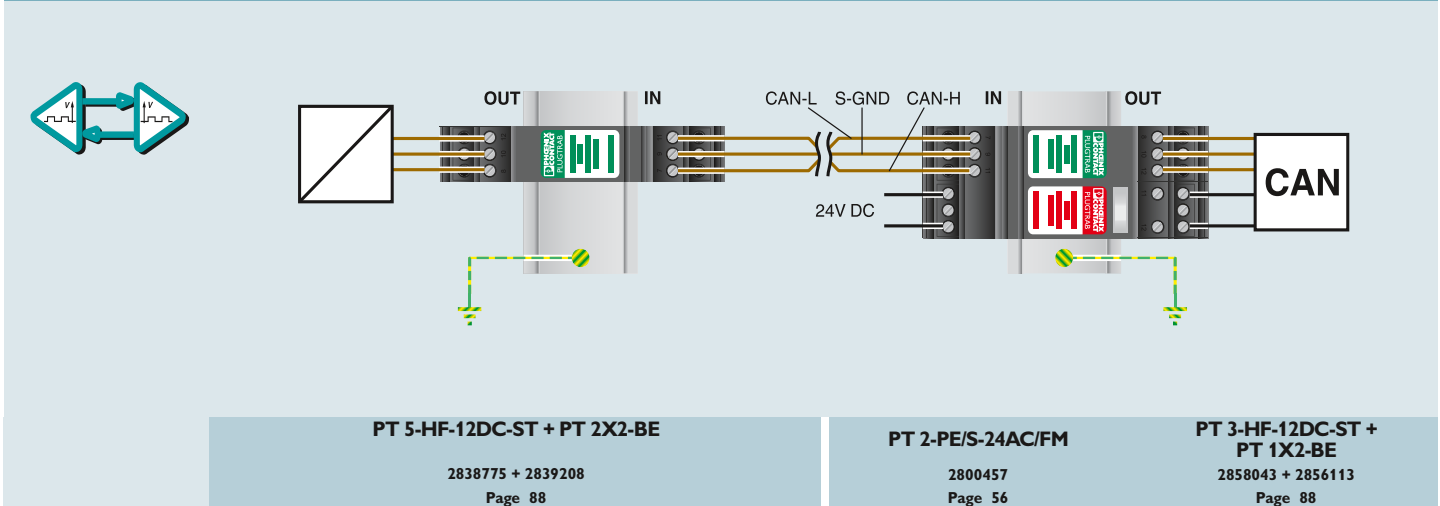



### Protection of an RS-485 interface

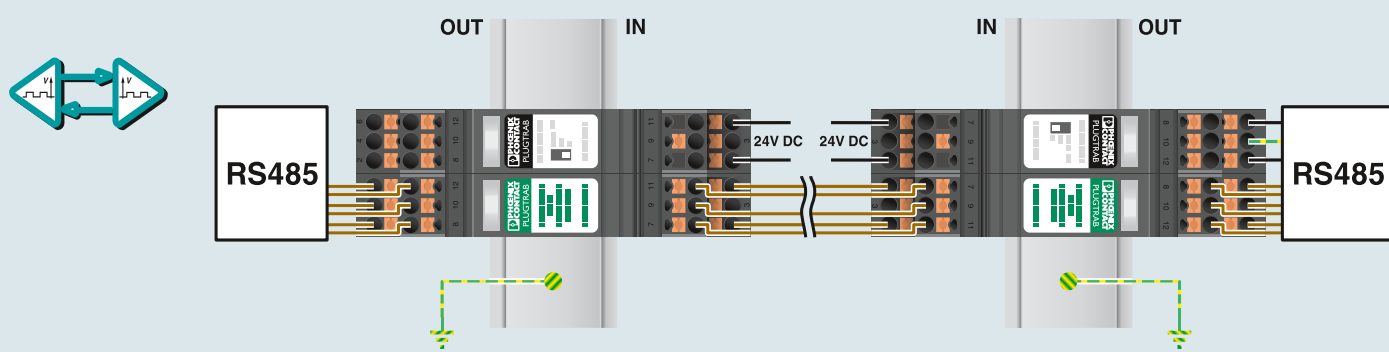

**PT-IQ-PTB-PT + PT-IQ-5-HF-12DC-PT**

2801296 + 2801293

Page 79

Optional

**PT 5-HF-12DC-ST + PT 2X2-BE**

2838775 + 2839208

Page 88

### Protection of an Ethernet interface (including PoE)

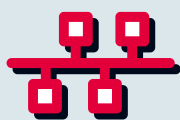

100Base-T  
1000Base-T  
10GBase-T

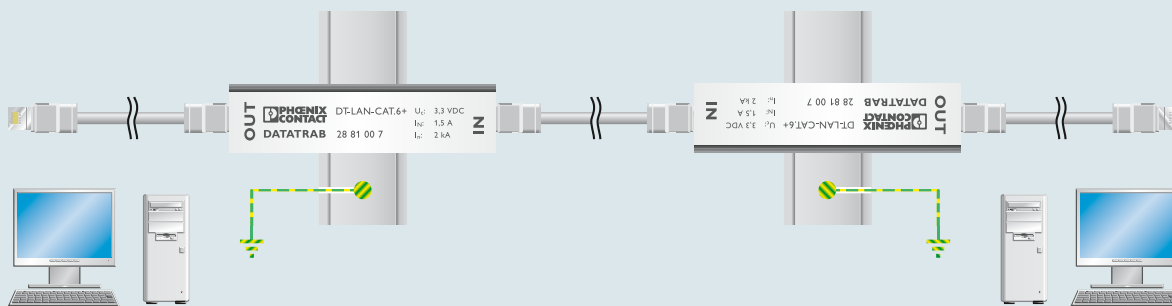

**DFLAN-CAT.6+**

2881007

Page 114

### Protection of a DSL interface

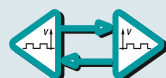

ADSL  
HDSL  
VDSL

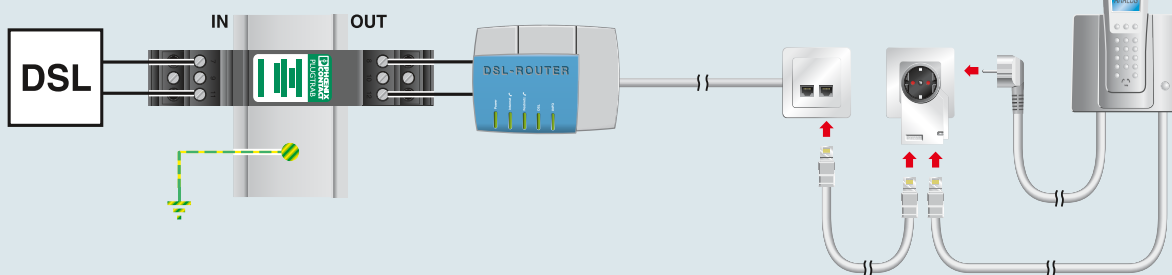

**PT 2-TELE**

2882828

Page 129

**MNT-TAE D/WH**

2882394

Page 130

# Surge protection and interference filters

## Selection guide and applications

### Protection of video signals

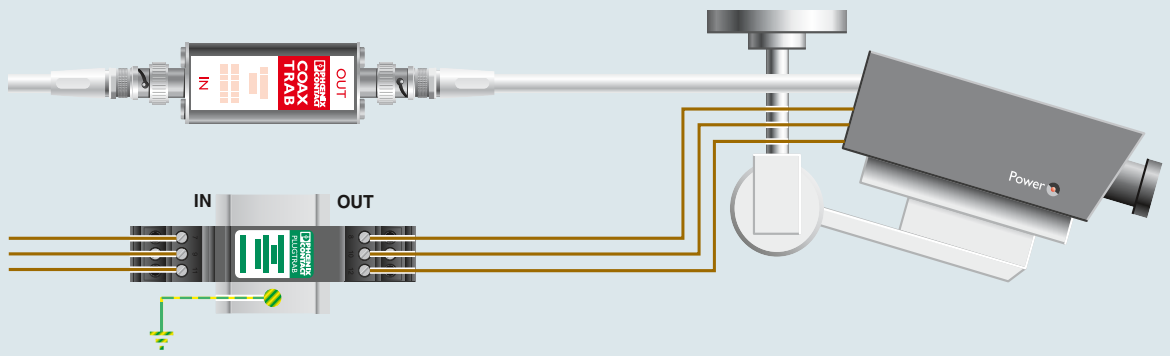
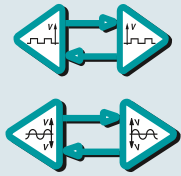

**C-UFB 5DC**  
2797858  
Page 140

**PT 3-HF-12DC-ST + PT 1X2-BE**  
2858043 + 2856113  
Page 116

### Protection of the SAT antenna connection

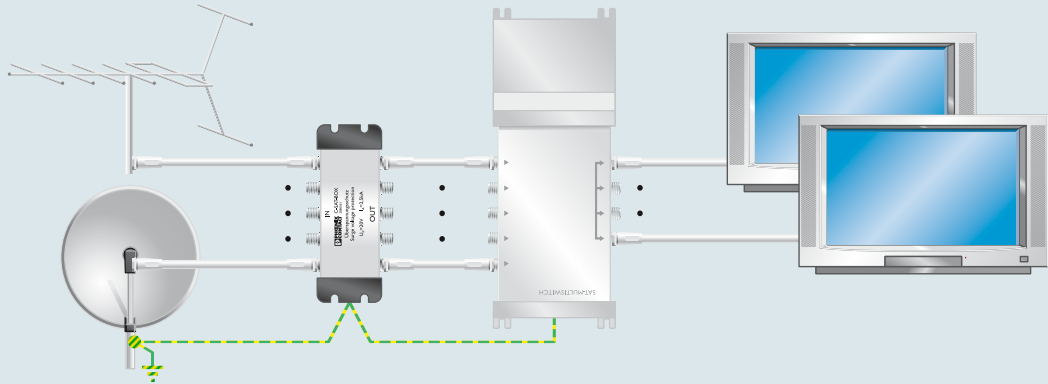
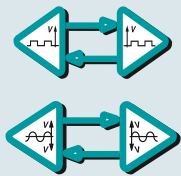

**C-SAT-BOX**  
2880561  
Page 142

### Protection of the cable TV connection

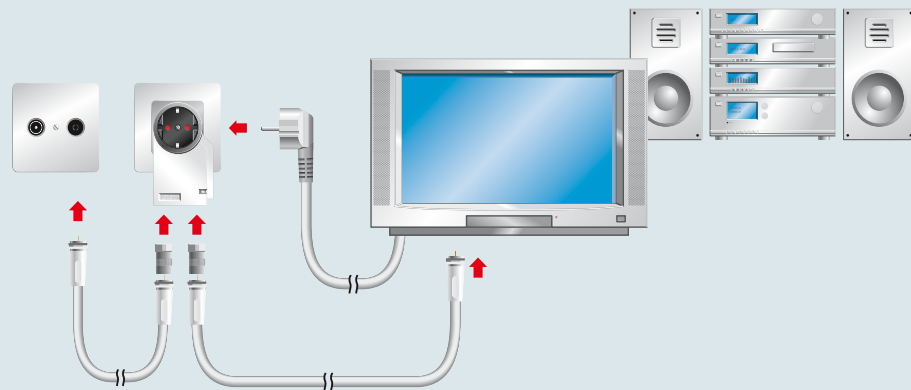
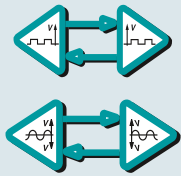

**MNT-TV-SAT D**  
2882284  
Page 143

Protection of antenna signals

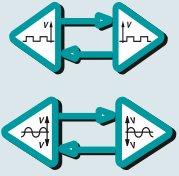

GPS  
GSM  
UMTS

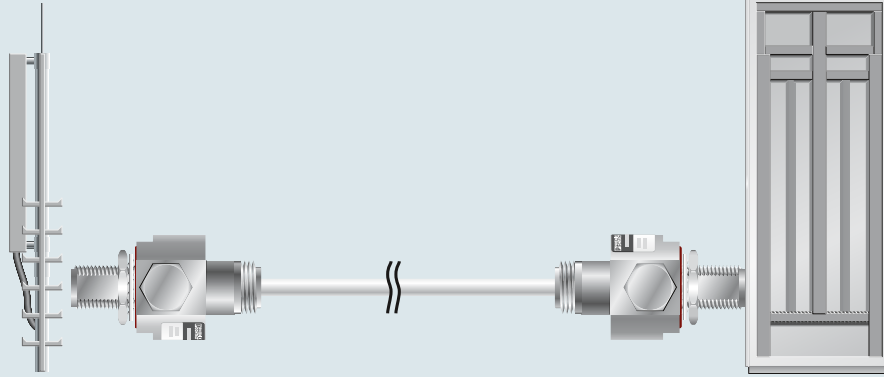

**CN-UB-280DC-3-BB**  
2801050  
Page 136

Optional

**CN-LAMBDA/4-2.25-BB**  
2801057  
Page 138



### The complete system

The protective devices in the “compact” range offer a consistent installation concept. Uniform and high-capacity modules are available for virtually all power supply systems. Be it lightning arrester, surge arrester or a combination of the two, the design will persuade you with its consistent and universal application.

### Worldwide use

The voltage fluctuations in power supplies vary from country to country. The surge protection also has to deal with these short-term (temporary) voltage fluctuations. Due to the high rated voltage of 350 V AC, the arresters in the “compact” range have no limitations and can be used in systems up to 240/415 V.

### FLASHTRAB compact PLUS

High-performance type 1 lightning arresters with low protection level based on spark gap technology for power supply systems up to 240/415 V.

### FLASHTRAB compact

Combined lighting and surge arrester for power supply systems up to 240/415 V.

### VALVETRAB compact

Space-saving surge arrester for all common power supply systems up to 240/415 V.

### Combined solutions

The VALVETRAB compact type 2 surge arresters, which are available as Combi-RCD surge protection with residual current device and Combi-MCB surge protection with coordinated backup fuse, are equipped with further functions.

### Device protection in multiple versions

Type 3 device protection is designed to provide protection for highly sensitive devices. Depending on installation location, the following protective devices are available, for example:

- For DIN rail mounting – PLUGTRAB PT
- For cable ducts – BLOCKTRAB
- Socket attachment plugs – MAINTRAB



### Plug-in to perfection

Universal plug-in capability ensures a high degree of comfort, e.g., for insulation measurements in the system. Instead of tampering with the installation, just pull out the plug.

The symmetrical plug design facilitates plugging in both directions within the base element. These protective devices can be installed in any control cabinet environment thanks to this flexible installation direction.



### Innovative technology

The high breaking capacity of the innovative spark gaps also enables their use in low-voltage high-current installations with short-circuit currents of up to 50 kA. The encapsulated lightning arresters are also able to limit line follow currents so that even small backup fuses are not affected.



### Status at a glance

The mechanical status indicator provides information locally at a glance.



### Remote signaling

A common floating remote indication contact enables remote signaling without taking up extra space.



### Different designs

Arresters in different designs are available for the various areas of application.

# Surge protection and interference filters

## Surge protection for the power supply unit

### Type 1 lightning arresters FLASHTRAB compact PLUS

- Seamless pluggability (even for N/PE spark gap)
- Thermal disconnect device for each individual connector
- Optical, mechanical status indication for the individual arresters
- With floating remote indication contact
- Connectors can be checked with CHECKMASTER
- High continuous voltage of 350 V AC for 230/400 V AC networks with high voltage fluctuations



5-conductor system; L1, L2, L3, N, PE



4-conductor system; L1, L2, L3, PEN

**Notes:**  
For certifications, see page 154

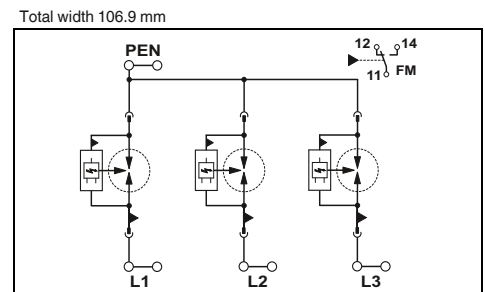
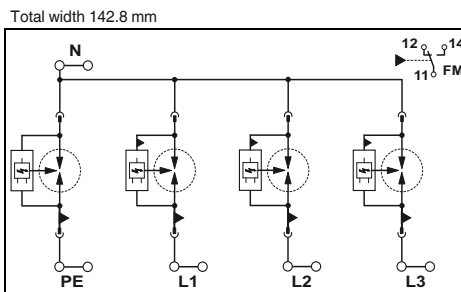

#### Technical data

#### Technical data

<b>Electrical data</b>	
IEC category / EN type	I / T1
Nominal voltage $U_N$	240 V AC (230/400 V AC ... 240/415 V AC)
Maximum continuous operating voltage $U_C$	L-N / N-PE / L-PEN 350 V AC / 350 V AC / -
Lightning test curr. $I_{imp}$ (10/350) $\mu$ s	Peak value 100 kA Charge 50 As Specific energy 2.50 MJ/ $\Omega$
Nominal discharge surge current $I_n$ (8/20) $\mu$ s	L-N / N-PE / L-PEN 25 kA / 100 kA / -
Follow current quenching capacity $I_{fi}$	L-N / N-PE / L-PEN 50 kA (264 V AC) / 100 A / -
Protection level $U_p$	L-N / N-PE / L-PEN $\leq 1.5$ kV / $\leq 1.5$ kV / -
Response time $t_A$	L-N / N-PE / L-PEN $\leq 100$ ns / $\leq 100$ ns / -
Backup fuse max. in acc. with IEC	315 A (gL/gG)
Immunity to short-circuiting (with max. backup fuse) $I_p$	50 kA
<b>General data</b>	
Dimensions W / H / D	142.8 mm / 97 mm / 71.5 mm
Connection data solid / stranded / AWG	2.5 ... 35 mm <sup>2</sup> / 2.5 ... 25 mm <sup>2</sup> / 13 - 2
Temperature range	-40 °C ... 80 °C
Inflammability class in acc. with UL 94	V0
Test standards	IEC 61643-1 / EN 61643-11 / EN 61643-11/A11 / UL 1449
<b>Remote indication contact</b>	
Connection data solid / stranded / AWG	PDT 0.14 ... 1.5 mm <sup>2</sup> / 0.14 ... 1.5 mm <sup>2</sup> / 28 - 16
Max. operating voltage	250 V AC / 125 V DC
Max. operating current	1 A AC / 200 mA DC

<b>Electrical data</b>	
IEC category / EN type	I / T1
Nominal voltage $U_N$	240 V AC (230/400 V AC ... 240/415 V AC)
Maximum continuous operating voltage $U_C$	- / - / 350 V AC
Lightning test curr. $I_{imp}$ (10/350) $\mu$ s	Peak value 75 kA Charge 37.5 As Specific energy 1.40 MJ/ $\Omega$
Nominal discharge surge current $I_n$ (8/20) $\mu$ s	- / - / 75 kA (3L-PEN)
Follow current quenching capacity $I_{fi}$	- / - / 50 kA (264 V AC)
Protection level $U_p$	- / - / $\leq 1.5$ kV
Response time $t_A$	- / - / $\leq 100$ ns
Backup fuse max. in acc. with IEC	315 A (gL/gG)
Immunity to short-circuiting (with max. backup fuse) $I_p$	50 kA
<b>General data</b>	
Dimensions W / H / D	106.9 mm / 95.8 mm / 70 mm
Connection data solid / stranded / AWG	2.5 ... 35 mm <sup>2</sup> / 2.5 ... 25 mm <sup>2</sup> / 13 - 2
Temperature range	-40 °C ... 80 °C
Inflammability class in acc. with UL 94	V0
Test standards	IEC 61643-1 / EN 61643-11 / EN 61643-11/A11 / UL 1449
<b>Remote indication contact</b>	
Connection data solid / stranded / AWG	PDT 0.14 ... 1.5 mm <sup>2</sup> / 0.14 ... 1.5 mm <sup>2</sup> / 28 - 16
Max. operating voltage	250 V AC / 125 V DC
Max. operating current	1 A AC / 200 mA DC

#### Ordering data

#### Ordering data

Description	Type	Order No.	Pcs. / Pkt.
FLASHTRAB compact PLUS	FLT-CP-PLUS-3S-350	2882640	1

Description	Type	Order No.	Pcs. / Pkt.
FLASHTRAB compact PLUS	FLT-CP-PLUS-3C-350	2882653	1

#### Accessories

#### Accessories

Replacement connector	Type	Order No.	Pcs. / Pkt.
L-N / L-PEN N-PE	FLT-CP-PLUS-350-ST	2859913	10
	FLT-CP-N/PE-350-ST	2859686	10

Replacement connector	Type	Order No.	Pcs. / Pkt.
L-N / L-PEN N-PE	FLT-CP-PLUS-350-ST	2859913	10

**Labeling material** ZBN 18 ..., see page 63

**Labeling material** ZBN 18 ..., see page 63



4-conductor system; L1, L2, N, PE



3-conductor system; L1, L2, PEN



3-conductor system; L, N, PE

Total width 106.9 mm

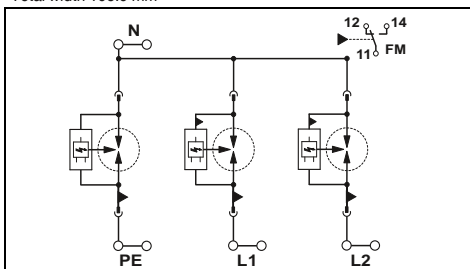

### Technical data

I / T1  
240 V AC (230/400 V AC ... 240/415 V AC)  
  
350 V AC / 350 V AC / -  
  
75 kA  
37.5 As  
1.40 MJ/Ω  
  
25 kA / 100 kA / -  
  
50 kA (264 V AC) / 100 A / -  
  
≤ 1.5 kV / ≤ 1.5 kV / -  
  
≤ 100 ns / ≤ 100 ns / -  
315 A (gL/gG)  
50 kA

106.9 mm / 95.8 mm / 70 mm  
2.5 ... 35 mm<sup>2</sup> / 2.5 ... 25 mm<sup>2</sup> / 13 - 2  
-40 °C ... 80 °C  
V0  
IEC 61643-1 / EN 61643-11 / EN 61643-11/A11 /  
UL 1449  
PDT  
0.14 ... 1.5 mm<sup>2</sup> / 0.14 ... 1.5 mm<sup>2</sup> / 28 - 16  
250 V AC / 125 V DC  
1 A AC / 200 mA DC

### Ordering data

Type	Order No.	Pcs. / Pkt.
FLT-CP-PLUS-2S-350	2882666	1

### Accessories

FLT-CP-PLUS-350-ST	2859913	10
FLT-CP-N/PE-350-ST	2859686	10

ZBN 18 ..., see page 63

Total width 71.6 mm

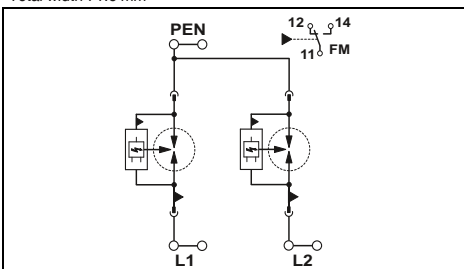

### Technical data

I / T1  
240 V AC (230/400 V AC ... 240/415 V AC)  
  
- / - / 350 V AC  
  
50 kA  
25 As  
625.00 kJ/Ω  
  
- / - / 25 kA  
  
- / - / 50 kA (264 V AC)  
  
- / - / ≤ 1.5 kV  
  
- / - / ≤ 100 ns  
315 A (gL/gG)  
50 kA

71.6 mm / 95.8 mm / 70 mm  
2.5 ... 35 mm<sup>2</sup> / 2.5 ... 25 mm<sup>2</sup> / 13 - 2  
-40 °C ... 80 °C  
V0  
IEC 61643-1 / EN 61643-11 / EN 61643-11/A11 /  
UL 1449  
PDT  
0.14 ... 1.5 mm<sup>2</sup> / 0.14 ... 1.5 mm<sup>2</sup> / 28 - 16  
250 V AC / 125 V DC  
1 A AC / 200 mA DC

### Ordering data

Type	Order No.	Pcs. / Pkt.
FLT-CP-PLUS-2C-350	2882679	1

### Accessories

FLT-CP-PLUS-350-ST	2859913	10
--------------------	---------	----

ZBN 18 ..., see page 63

Total width 71.6 mm

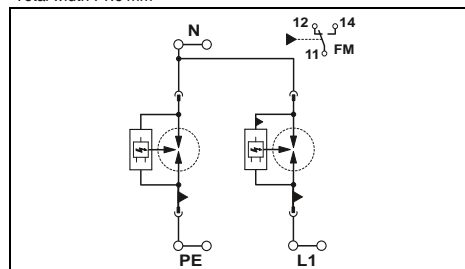

### Technical data

I / T1  
240 V AC (230/400 V AC ... 240/415 V AC)  
  
350 V AC / 350 V AC / -  
  
50 kA  
25 As  
625.00 kJ/Ω  
  
25 kA / 100 kA / -  
  
50 kA (264 V AC) / 100 A / -  
  
≤ 1.5 kV / ≤ 1.5 kV / -  
  
≤ 100 ns / ≤ 100 ns / -  
315 A (gL/gG)  
50 kA

71.6 mm / 95.8 mm / 70 mm  
2.5 ... 35 mm<sup>2</sup> / 2.5 ... 25 mm<sup>2</sup> / 13 - 2  
-40 °C ... 80 °C  
V0  
IEC 61643-1 / EN 61643-11 / EN 61643-11/A11 /  
UL 1449  
PDT  
0.14 ... 1.5 mm<sup>2</sup> / 0.14 ... 1.5 mm<sup>2</sup> / 28 - 16  
250 V AC / 125 V DC  
1 A AC / 200 mA DC

### Ordering data

Type	Order No.	Pcs. / Pkt.
FLT-CP-PLUS-1S-350	2882682	1

### Accessories

FLT-CP-PLUS-350-ST	2859913	10
FLT-CP-N/PE-350-ST	2859686	10

ZBN 18 ..., see page 63

# Surge protection and interference filters

## Surge protection for the power supply unit

### Type 1 lightning arresters FLASHTRAB compact PLUS

- Seamless pluggability (even for N/PE spark gap)
- Thermal disconnect device for each individual connector
- Optical, mechanical status indication for the individual arresters
- With floating indication contact
- Connectors can be checked with CHECKMASTER
- High continuous voltage of 350 V AC for 230/400 V AC networks with high voltage fluctuations



2-conductor system; L, PEN



N-PE spark gap,  
for Lightning Protection Level 1

**Notes:**  
For certifications, see page 154

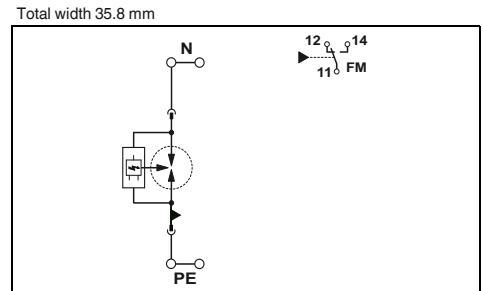
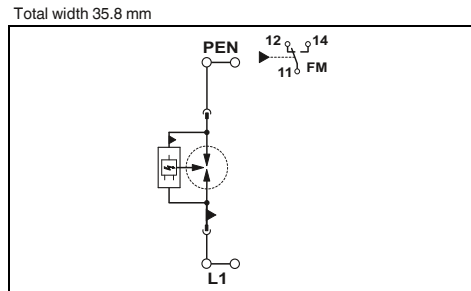

Electrical data	
IEC category / EN type	L-N / N-PE / L-PEN
Nominal voltage $U_N$	350 V AC / - / 350 V AC
Maximum continuous operating voltage $U_C$	- / 350 V AC / -
Lightning test curr. $I_{imp}$ (10/350) $\mu$ s	25 kA
	Peak value
	Charge
	Specific energy
Nominal discharge surge current $I_n$ (8/20) $\mu$ s	25 kA / - / 25 kA
Follow current quenching capacity $I_{fi}$	- / 100 kA / -
Protection level $U_p$	50 kA (264 V AC) / - / 50 kA (264 V AC)
Response time $t_{\lambda}$	- / $\leq 1.5$ kV / -
Backup fuse max. in acc. with IEC	- / $\leq 100$ ns
Immunity to short-circuiting (with max. backup fuse) $I_p$	315 A (gL/gG)
	50 kA
General data	
Dimensions W / H / D	35.8 mm / 95.8 mm / 70 mm
Connection data solid / stranded / AWG	2.5 ... 35 mm <sup>2</sup> / 2.5 ... 25 mm <sup>2</sup> / 13 - 2
Temperature range	-40 °C ... 80 °C
Inflammability class in acc. with UL 94	V0
Test standards	IEC 61643-1 / EN 61643-11 / EN 61643-11/A11 / UL 1449
Remote indication contact	
Connection data solid / stranded / AWG	PDT
Max. operating voltage	0.14 ... 1.5 mm <sup>2</sup> / 0.14 ... 1.5 mm <sup>2</sup> / 28 - 16
Max. operating current	250 V AC / 125 V DC
	1 A AC / 200 mA DC

Technical data	
I / T1	240 V AC (230/400 V AC ... 240/415 V AC)
L-N / N-PE / L-PEN	350 V AC / - / 350 V AC
Peak value	25 kA
Charge	12.5 As
Specific energy	160.00 kJ/Ω
L-N / N-PE / L-PEN	25 kA / - / 25 kA
L-N / N-PE / L-PEN	50 kA (264 V AC) / - / 50 kA (264 V AC)
L-N / N-PE / L-PEN	$\leq 1.5$ kV / - / $\leq 1.5$ kV
L-N / N-PE / L-PEN	- / - / $\leq 100$ ns
	315 A (gL/gG)
	50 kA

Technical data	
I / T1	240 V AC (N-PE)
- / 350 V AC / -	- / 350 V AC / -
100 kA	100 kA
50 As	50 As
2.50 MJ/Ω	2.50 MJ/Ω
- / 100 kA / -	- / 100 kA / -
- / 100 A / -	- / 100 A / -
- / $\leq 1.5$ kV / -	- / $\leq 1.5$ kV / -
- / $\leq 100$ ns / -	- / $\leq 100$ ns / -
-	-
25 kA	25 kA

Ordering data	
Description	FLASHTRAB compact PLUS
Description	FLASHTRAB compact

Ordering data		
Type	Order No.	Pcs. / Pkt.
FLT-CP-PLUS-1C-350	2882695	1

Ordering data		
Type	Order No.	Pcs. / Pkt.
FLT-CP-N/PE-350	2859754	1

Accessories	
Replacement connector	L-N / L-PEN N-PE
Labeling material	ZBN 18 ..., see page 63

Accessories		
Type	Order No.	Pcs. / Pkt.
FLT-CP-PLUS-350-ST	2859913	10

Accessories		
Type	Order No.	Pcs. / Pkt.
FLT-CP-N/PE-350-ST	2859686	10



### Type 1 lightning arresters FLASHTRAB

- 1-channel
- Triggered
- High discharge capacity
- Good follow current quenching capacity with higher rated voltage
- Direct parallel connection with type 2 arresters supported

**Notes:**

For certifications, see page 154



2.5 kV/3 kV protection level



N-PE spark gap, single-channel, plug-in

Total width 35.5 mm

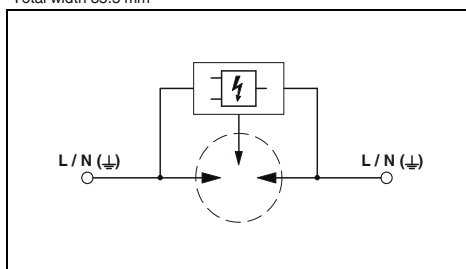

Total width 35.8 mm

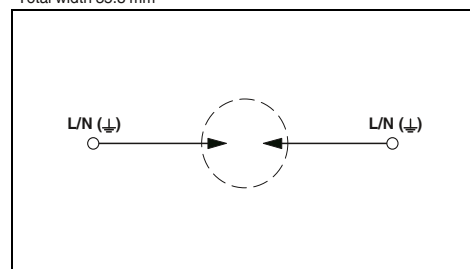

**Technical data**

Electrical data	... 2.5	... 3.0
IEC category / EN type	I / T1	I / T1
Nominal voltage $U_N$	230 V AC (400 V AC)	230 V AC (400 V AC)
Maximum continuous operating voltage $U_c$	L-N / N-PE / L-PEN 440 V AC / - / 440 V AC	440 V AC / - / 440 V AC
Lightning test curr. $I_{imp}$ (10/350) $\mu$ s	Peak value	50 kA
	Charge	25 As
	Specific energy	625.00 kJ/ $\Omega$
	Nominal discharge surge current $I_n$ (8/20) $\mu$ s	L-N / N-PE / L-PEN 50 kA / - / 50 kA
Protection level $U_p$	L-N / N-PE / L-PEN $\leq 2.5$ kV / - / $\leq 2.5$ kV	$\leq 3$ kV / - / $\leq 3$ kV
Response time $t_A$	L-N / N-PE / L-PEN $\leq 100$ ns / - / $\leq 100$ ns	$\leq 100$ ns / - / $\leq 100$ ns
Backup fuse max. in acc. with IEC		500 A (NH-gL)
Immunity to short-circuiting (with max. backup fuse) $I_p$		25 kA (440 V AC)

**Technical data**

Electrical data	... 1.5	
IEC category / EN type	I / T1	
Nominal voltage $U_N$	230 V AC (N-PE)	
Maximum continuous operating voltage $U_c$	- / 260 V AC / -	
Lightning test curr. $I_{imp}$ (10/350) $\mu$ s	Peak value	100 kA
	Charge	50 As
	Specific energy	2.50 MJ/ $\Omega$ (N-PE)
	Nominal discharge surge current $I_n$ (8/20) $\mu$ s	- / 100 kA / -
Protection level $U_p$	- / $\leq 1.5$ kV / -	
Response time $t_A$	- / $\leq 100$ ns / -	
Backup fuse max. in acc. with IEC	-	
Immunity to short-circuiting (with max. backup fuse) $I_p$	-	

<b>General data</b>	
Dimensions W / H / D	35.5 mm / 150 mm / 80.5 mm
Connection data solid / stranded / AWG	10 ... 50 mm <sup>2</sup> / 16 ... 35 mm <sup>2</sup> / 6 - 1
Temperature range	-40 °C ... 85 °C
Inflammability class in acc. with UL 94	V0
Test standards	IEC 61643-1 / DIN EN 61643-11 / DIN EN 61643-11/A11

<b>General data</b>	
Dimensions W / H / D	35.8 mm / 95.8 mm / 70 mm
Connection data solid / stranded / AWG	2.5 ... 35 mm <sup>2</sup> / 2.5 ... 25 mm <sup>2</sup> / 13 - 2
Temperature range	-40 °C ... 80 °C
Inflammability class in acc. with UL 94	V0
Test standards	IEC 61643-1 / EN 61643-11 / EN 61643-11/A11

**Ordering data**

Description	Type	Order No.	Pcs. / Pkt.
FLASHTRAB PLUS CTRL Without status indicator	FLT-PLUS CTRL-2.5	2800121	1
	FLT-PLUS CTRL-3.0	2800168	1
FLASHTRAB PLUS CTRL With status indicator	FLT-PLUS CTRL-2.5/I	2800122	1
	FLT-PLUS CTRL-3.0/I	2800170	1
FLASHTRAB			

**Ordering data**

Type	Order No.	Pcs. / Pkt.
FLT 100 N/PE-1.5	2800303	1

**Accessories**

Labeling material	ZBN 18 ..., see page 63
Wiring bridge	MPB ..., see page 61

**Accessories**

Labeling material	ZBN 18 ..., see page 63
Wiring bridge	MPB ..., see page 61

# Surge protection and interference filters

## Surge protection for the power supply unit

### Type 1 lightning arresters POWERTRAB

- Type 1 arrester based on a varistor
- Meets Lightning Protection Level I
- Universal solution for various network types:
  - 500 ... 690 V AC IT systems
  - 554/960 V AC TN-C systems
  - 400/690 V AC TN-C systems
- Multi-stage status monitoring via remote indication contact
- Local optical status indication
- Encapsulated, non-extinguishing
- Free of leakage current/no line follow current
- Very high TOV resistance
- Meets installation requirements according to CLC/TS 50539-22
- Use in harsh industrial environments

**Notes:**  
For certifications, see page 154



Single-channel

Total width 56 mm

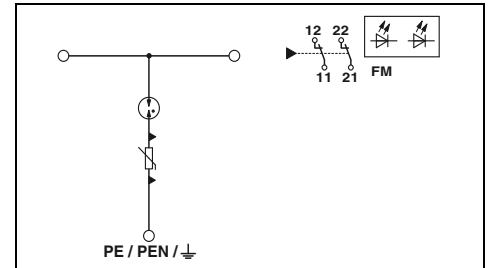

#### Technical data

<b>Electrical data</b>	
IEC category	I, II / T1, T2
Nominal voltage $U_N$	690 V AC
Maximum continuous operating voltage $U_C$	800 V AC
TOV behavior at $U_T$	1500 V AC (5 sec.)
Nominal load current $I_L$	150 A (Serial through wiring with 50 mm <sup>2</sup> )
Nominal discharge surge current $I_{t1}$ (8/20) $\mu$ s	35 kA
Max. discharge surge current $I_{max}$ (8/20) $\mu$ s	100 kA
Lightning test current $I_{imp}$ (10/350) $\mu$ s	35 kA
	Peak value $I_{imp}$
Protection level $U_p$	$\leq 4.5$ kV
Max. required backup fuse with branch wiring	400 A (gG; 2 x 50 mm <sup>2</sup> ) 800 A (aR)
Max. required backup fuse with V-type through wiring	150 A (gG; $\geq 35$ mm <sup>2</sup> )
Short-circuit resistance $I_p$ with max. backup fuse (effective)	50 kA
<b>General data</b>	
Dimensions W / H / D	56 mm / - / 191 mm
Ambient temperature (operation)	-40 °C ... 80 °C
Degree of protection in acc. with IEC 60529/ EN 60529	IP20
Housing material	PA / PC
Inflammability class in acc. with UL 94	V-2
Test standards	IEC 61643-11 / EN 61643-11/A11
<b>Conductor</b>	
Connection name	Double terminal point
Connection method	Screw connection
Screw thread	M6
Connection data solid / stranded / AWG	16 ... 50 mm <sup>2</sup> / 16 ... 50 mm <sup>2</sup> / 6 - 1/0
<b>Protective conductor connection</b>	
Connection name	PE conductor connection
Connection method	Ring cable lug
Screw thread	M10
Connection data solid / stranded / AWG	16 ... 95 mm <sup>2</sup> / 16 ... 95 mm <sup>2</sup> / 6 - 3/0
<b>Remote indication contact</b>	
Connection data solid / stranded / AWG	N/C contact 1-pos.
Max. operating voltage	0.2 ... 2.5 mm <sup>2</sup> / 0.2 ... 2.5 mm <sup>2</sup> / 24 - 12
Max. operating current	30 V AC / 30 V DC 1.5 A AC / 1.5 A DC

#### Ordering data

Description	Type	Order No.	Pcs. / Pkt.
<b>POWERTRAB</b>			
<b>Mounting set</b> , comprising: 1x PE aluminum rail (147.5 x 30 x 3 mm), 3x M10x20 hexagon-head screw, 3x M10 hexagonal nut, 3x M10 washer, 3x M10 spring washer, 1x installation instructions	<b>PWT 35-800AC-FM</b>	<b>2800419</b>	<b>1</b>

H  
D  
W



4-conductor system; L1, L2, L3, PE/PEN



Mounting set

Total width 176 mm

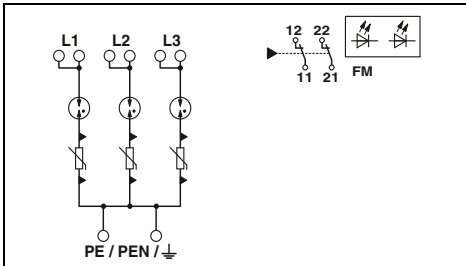

### Technical data

I, II / T1, T2  
 690 V AC  
 800 V AC  
 1500 V AC (5 sec.)  
 150 A (Serial through wiring with 50 mm<sup>2</sup>)  
 35 kA (per position)  
 100 kA (per position)

35 kA (per position)  
 ≤ 4.5 kV  
 400 A (gG; 2 x 50 mm<sup>2</sup>)  
 800 A (aR)  
 150 A (gG; ≥ 35 mm<sup>2</sup>)

50 kA

176 mm / - / 191 mm  
 -40 °C ... 80 °C  
 IP20  
 PA / PC  
 V-2  
 IEC 61643-11 / EN 61643-11/A11

Double terminal point  
 Screw connection  
 M6  
 16 ... 50 mm<sup>2</sup> / 16 ... 50 mm<sup>2</sup> / 6 - 1/0

PE conductor connection  
 Ring cable lug  
 M10  
 16 ... 95 mm<sup>2</sup> / 16 ... 95 mm<sup>2</sup> / 6 - 3/0  
 N/C contact 1-pos.  
 0.2 ... 2.5 mm<sup>2</sup> / 0.2 ... 2.5 mm<sup>2</sup> / 24 - 12  
 30 V AC / 30 V DC  
 1.5 A AC / 1.5 A DC

### Ordering data

Type	Order No.	Pcs. / Pkt.
PWT 100-800AC-FM	2800531	1

### Ordering data

Type	Order No.	Pcs. / Pkt.
PWT CCT-SET	2800532	1

# Surge protection and interference filters

## Surge protection for the power supply unit

### Type 1/2 lightning arrester/surge arrester

#### VAL-MS-T1/T2

- Seamless pluggability (even for N/PE spark gap)
- Secure hold of connectors in the event of high lightning current loads and strong vibration thanks to new latching
- Thermal disconnect device for each individual connector
- Optical, mechanical status indication for the individual arresters
- With or without floating remote indication contact
- Mechanical keying of all slots
- Connectors can be checked with CHECKMASTER



5-conductor system;  
L1, L2, L3, N, PE (3+1 circuit)



5-conductor system;  
L1, L2, L3, N, PE (4+0 circuit)

**Notes:**  
For certifications, see page 154

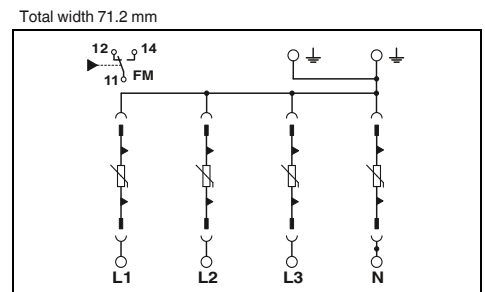
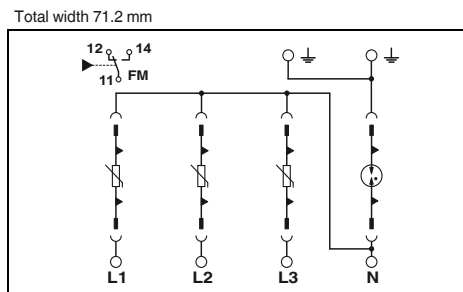

Electrical data	
IEC category / EN type	
Nominal voltage $U_N$	
Maximum continuous operating voltage $U_C$	
Lightning test curr. $I_{imp}$ (10/350) $\mu$ s	
Follow current quenching capacity $I_{fl}$	
Nominal discharge surge current $I_n$ (8/20) $\mu$ s	
Max. discharge surge current $I_{max}$ (8/20) $\mu$ s	
Protection level $U_p$	
Backup fuse max. in acc. with IEC	
General data	
Dimensions W / H / D	
Connection data solid / stranded / AWG	
Temperature range	
Inflammability class in acc. with UL 94	
Test standards	
Remote indication contact	
Connection data solid / stranded / AWG	
Max. operating voltage	
Max. operating current	

Technical data	
...335	...175
I, II / T1, T2	I, II / T1, T2
240 V AC (230/400 V AC ... 240/415 V AC)	120 V AC
L-N / L-PE / N-PE / L-PEN	L-N / L-PE / N-PE / L-PEN
335 V AC / - / 264 V AC / -	175 V AC / - / 264 V AC / -
Peak value	50 kA
Charge	25 As
Specific energy	625.00 kJ/ $\Omega$
L-N / L-PE / N-PE / L-PEN	L-N / L-PE / N-PE / L-PEN
- / - / 100 A (264 V AC) / -	- / - / 100 A (264 V AC) / -
L-N / L-PE / N-PE / L-PEN	L-N / L-PE / N-PE / L-PEN
12.5 kA / - / 50 kA / -	12.5 kA / - / 50 kA / -
L-N / L-PE / N-PE / L-PEN	L-N / L-PE / N-PE / L-PEN
50 kA / - / 50 kA / -	50 kA / - / 50 kA / -
L-N / L-PE / N-PE / L-PEN	L-N / L-PE / N-PE / L-PEN
$\leq 1.2$ kV / $\leq 2$ kV / $\leq 1.7$ kV / -	$\leq 0.8$ kV / $\leq 2$ kV / $\leq 1.7$ kV / -
160 A (gL/gG)	160 A (gL/gG)
71.2 mm / 99 mm / 77.5 mm	
1.5 ... 35 mm <sup>2</sup> / 1.5 ... 25 mm <sup>2</sup> / 15 - 2	
-40 °C ... 80 °C	
V0	
IEC 61643-1 / EN 61643-11/A11	
PDT, 1-pos.	
0.14 ... 1.5 mm <sup>2</sup> / 0.14 ... 1.5 mm <sup>2</sup> / 28 - 16	
250 V AC / 30 V DC	
1.5 A AC (250 V AC) / 1.5 A DC (30 V DC)	

Technical data	
...335	...175
I, II / T1, T2	I, II / T1, T2
240 V AC (230/400 V AC ... 240/415 V AC)	120 V AC
L-N / L-PE / N-PE / L-PEN	L-N / L-PE / N-PE / L-PEN
335 V AC / 335 V AC / -	175 V AC / - / 264 V AC / -
50 kA	50 kA
25 As	25 As
625.00 kJ/ $\Omega$	625.00 kJ/ $\Omega$
L-N / L-PE / N-PE / L-PEN	L-N / L-PE / N-PE / L-PEN
- / - / 100 A (264 V AC) / -	- / - / 100 A (264 V AC) / -
L-N / L-PE / N-PE / L-PEN	L-N / L-PE / N-PE / L-PEN
- / 37.5 kA (3 x L) / 12.5 kA / -	12.5 kA / - / 50 kA / -
L-N / L-PE / N-PE / L-PEN	L-N / L-PE / N-PE / L-PEN
- / 150 kA (3 x L) / 50 kA / -	50 kA / - / 50 kA / -
L-N / L-PE / N-PE / L-PEN	L-N / L-PE / N-PE / L-PEN
- / $\leq 1.2$ kV / $\leq 1.2$ kV / -	$\leq 0.8$ kV / $\leq 2$ kV / $\leq 1.7$ kV / -
160 A (gL/gG)	160 A (gL/gG)
71.2 mm / 99 mm / 77.5 mm	
1.5 ... 35 mm <sup>2</sup> / 1.5 ... 25 mm <sup>2</sup> / 15 - 2	
-40 °C ... 80 °C	
V0	
IEC 61643-1 / EN 61643-11/A11	
PDT, 1-pos.	
0.14 ... 1.5 mm <sup>2</sup> / 0.14 ... 1.5 mm <sup>2</sup> / 28 - 16	
250 V AC	
1.5 A AC (250 V AC) / 1.5 A DC (30 V DC)	

Description	$U_C$
<b>VALVETRAB-MS</b> , varistor-based lightning arrester	
with remote indication contact	335 V AC
without remote indication contact	335 V AC
with remote indication contact	175 V AC
without remote indication contact	175 V AC
with remote indication contact	75 V AC
without remote indication contact	75 V AC

Ordering data			
Type	Order No.	Pcs. / Pkt.	
VAL-MS-T1/T2 335/12.5/3+1-FM	2800183	1	
VAL-MS-T1/T2 335/12.5/3+1	2800184	1	
VAL-MS-T1/T2 175/12.5/3+1-FM	2800670	1	
VAL-MS-T1/T2 175/12.5/3+1	2800671	1	

Ordering data			
Type	Order No.	Pcs. / Pkt.	
VAL-MS-T1/T2 335/12.5/4+0-FM	2800644	1	
VAL-MS-T1/T2 335/12.5/4+0	2800645	1	

Replacement connector	
L-N / L-PEN	VAL-MS-T1/T2 335/12.5 ST
L-N / L-PEN	VAL-MS-T1/T2 175/12.5 ST
L-N / L-PEN	F-MS-T1/T2 50 ST
N-PE	

Accessories			
Type	Order No.	Pcs. / Pkt.	
VAL-MS-T1/T2 335/12.5 ST	2800190	10	
VAL-MS-T1/T2 175/12.5 ST	2800676	10	
F-MS-T1/T2 50 ST	2800191	10	

Accessories			
Type	Order No.	Pcs. / Pkt.	
VAL-MS-T1/T2 335/12.5 ST	2800190	10	

Labeling material

ZBN 18 ..., see page 63

ZBN 18 ..., see page 63



4-conductor system; L1, L2, L3, PEN



3-conductor system; L, N, PE



2-conductor system; L, N/PEN

Total width 53.4 mm

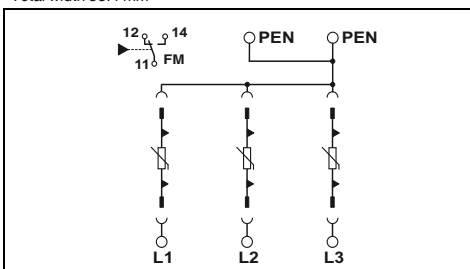

Total width 35.6 mm

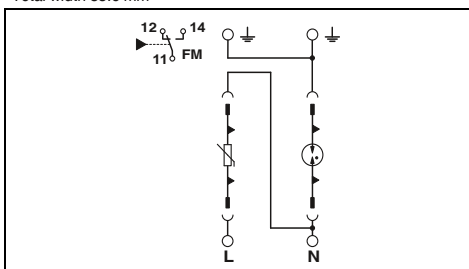

Total width 17.5 mm

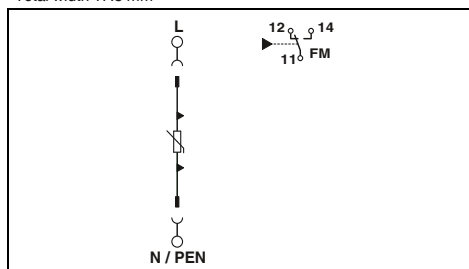

Technical data	
...335	...175
I, II / T1, T2	I, II / T1, T2
240 V AC (230/400 V AC ...)	120 V AC
240/415 V AC)	
- / - / - / 335 V AC	- / - / - / 175 V AC
37.5 kA	37.5 kA
18.75 As	18.75 As
352.00 kJ/Ω	352.00 kJ/Ω
-	-
- / - / - / 37.5 kA (3 x L)	- / - / - / 37.5 kA (3 x L)
- / - / - / 150 kA (3 x L)	- / - / - / 150 kA (3 x L)
- / - / - / ≤ 1.2 kV	- / - / - / ≤ 0.7 kV
160 A (gL/gG)	160 A (gL/gG)

Technical data	
...335	...175
I, II / T1, T2	I, II / T1, T2
240 V AC	120 V AC
(230 V AC ... 240 V AC)	
335 V AC / - / - / 264 V AC / -	175 V AC / - / - / 264 V AC / -
25 kA	25 kA
12.5 As	12.5 As
160.00 kJ/Ω	160.00 kJ/Ω
- / - / 100 A (264 V AC) / -	- / - / 100 A (264 V AC) / -
12.5 kA / - / 50 kA / -	12.5 kA / - / 50 kA / -
50 kA / - / 50 kA / -	50 kA / - / 50 kA / -
≤ 1.2 kV / ≤ 2 kV / ≤ 1.7 kV / -	≤ 0.8 kV / ≤ 2 kV / ≤ 1.7 kV / -
160 A (gL/gG)	160 A (gL/gG)

Technical data		
...335	...175	... 48
I, II / T1, T2	I, II / T1, T2	I, II / T1, T2
240 V AC	120 V AC	60 V AC/DC
335 V AC / - / - / -	175 V AC / - / - / -	75 V AC / - / - / -
12.5 kA	12.5 kA	12.5 kA
6.25 As	6.25 As	6.25 As
39.00 kJ/Ω	39.00 kJ/Ω	39.00 kJ/Ω
-	-	-
- / - / - / 12.5 kA	- / - / - / 12.5 kA	- / - / - / 12.5 kA
- / - / - / 50 kA	- / - / - / 50 kA	- / - / - / 30 kA
≤ 1.2 kV / - / - / -	≤ 0.8 kV / - / - / -	≤ 0.4 kV / - / - / -
160 A (gL/gG)	160 A (gL/gG)	160 A (gL/gG)

53.4 mm / 99 mm / 77.5 mm
1.5 ... 35 mm <sup>2</sup> / 1.5 ... 25 mm <sup>2</sup> / 15 - 2
-40 °C ... 80 °C
V0
IEC 61643-1 / EN 61643-11/A11
PDT, 1-pos.
0.14 ... 1.5 mm <sup>2</sup> / 0.14 ... 1.5 mm <sup>2</sup> / 28 - 16
250 V AC / 30 V DC
1.5 A AC (250 V AC) / 1.5 A DC (30 V DC)

35.6 mm / 99 mm / 77.5 mm
1.5 ... 35 mm <sup>2</sup> / 1.5 ... 25 mm <sup>2</sup> / 15 - 2
-40 °C ... 80 °C
V0
IEC 61643-1 / EN 61643-11/A11
PDT, 1-pos.
0.14 ... 1.5 mm <sup>2</sup> / 0.14 ... 1.5 mm <sup>2</sup> / 28 - 16
250 V AC / 30 V DC
1.5 A AC (250 V AC) / 1.5 A DC (30 V DC)

17.5 mm / 99 mm / 77.5 mm
1.5 ... 35 mm <sup>2</sup> / 1.5 ... 25 mm <sup>2</sup> / 15 - 2
-40 °C ... 80 °C
V0
IEC 61643-1 / EN 61643-11/A11
PDT, 1-pos.
0.14 ... 1.5 mm <sup>2</sup> / 0.14 ... 1.5 mm <sup>2</sup> / 28 - 16
250 V AC
1.5 A AC / 1.5 A DC (30 V DC)

Ordering data		
Type	Order No.	Pcs. / Pkt.
VAL-MS-T1/T2 335/12.5/3+0-FM	2800188	1
VAL-MS-T1/T2 335/12.5/3+0	2800189	1
VAL-MS-T1/T2 175/12.5/3+0-FM	2800672	1
VAL-MS-T1/T2 175/12.5/3+0	2800673	1

Ordering data		
Type	Order No.	Pcs. / Pkt.
VAL-MS-T1/T2 335/12.5/1+1-FM	2800186	1
VAL-MS-T1/T2 335/12.5/1+1	2800187	1
VAL-MS-T1/T2 175/12.5/1+1-FM	2800674	1
VAL-MS-T1/T2 175/12.5/1+1	2800675	1

Ordering data		
Type	Order No.	Pcs. / Pkt.
VAL-MS-T1/T2 335/12.5/1+0-FM	2801042	1
VAL-MS-T1/T2 335/12.5/1+0	2801041	1
VAL-MS-T1/T2 175/12.5/1+0-FM	2801044	1
VAL-MS-T1/T2 175/12.5/1+0	2801043	1
VAL-MS-T1/T2 48/12.5/1+0-FM	2801240	1
VAL-MS-T1/T2 48/12.5/1+0	2801241	1

Accessories		
Type	Order No.	Pcs. / Pkt.
VAL-MS-T1/T2 335/12.5 ST	2800190	10
VAL-MS-T1/T2 175/12.5 ST	2800676	10

Accessories		
Type	Order No.	Pcs. / Pkt.
VAL-MS-T1/T2 335/12.5 ST	2800190	10
VAL-MS-T1/T2 175/12.5 ST	2800676	10
F-MS-T1/T2 50 ST	2800191	10

Accessories		
Type	Order No.	Pcs. / Pkt.
VAL-MS-T1/T2 335/12.5 ST	2800190	10
VAL-MS-T1/T2 175/12.5 ST	2800676	10
VAL-MS-T1/T2 48/12.5 ST	2801242	10

ZBN 18 ..., see page 63

ZBN 18 ..., see page 63

ZBN 18 ..., see page 63

# Surge protection and interference filters

## Surge protection for the power supply unit

### Type 1+2 lightning/surge arrester combination FLASHTRAB compact

- Seamless pluggability (even for N/PE spark gap)
- Thermal disconnect device for each individual connector
- Optical, mechanical status indication for the individual arresters
- With floating remote indication contact
- Connectors can be checked with CHECKMASTER
- High continuous voltage of 350 V AC for 230/400 V AC networks with high voltage fluctuations



5-conductor system; L1, L2, L3, N, PE

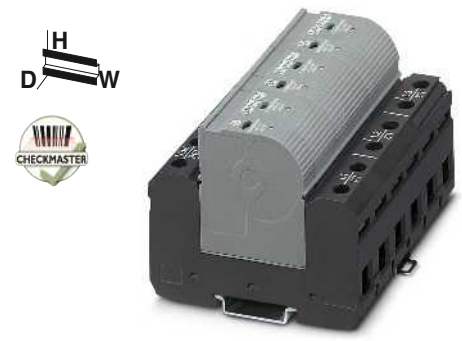

4-conductor system; L1, L2, L3, PEN

**Notes:**  
For certifications, see page 154

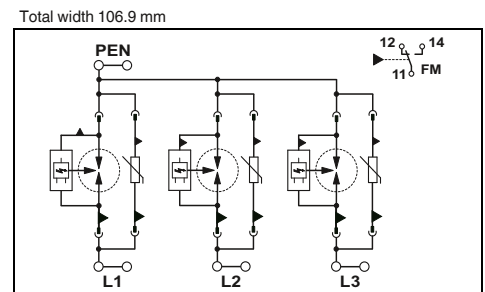
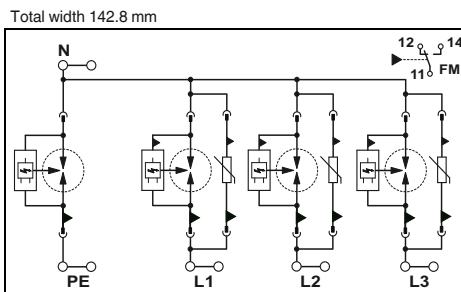

Electrical data	
IEC category / EN type	I + II / T1 + T2
Nominal voltage $U_N$	240 V AC (230/400 V AC ... 240/415 V AC)
Maximum continuous operating voltage $U_C$	L-N / N-PE / L-PEN 350 V AC / 350 V AC / -
Lightning test curr. $I_{imp}$ (10/350) $\mu$ s	Peak value 100 kA Charge 50 As Specific energy 2.50 MJ/Ω
Nominal discharge surge current $I_n$ (8/20) $\mu$ s	L-N / N-PE / L-PEN 25 kA / 100 kA / -
Follow current quenching capacity $I_{fi}$	L-N / N-PE / L-PEN 25 kA (264 V AC) / 100 A / -
Protection level $U_p$	L-N / N-PE / L-PEN $\leq 1.5$ kV / $\leq 1.5$ kV / -
Response time $t_A$	L-N / N-PE / L-PEN $\leq 25$ ns / $\leq 100$ ns / -
Backup fuse max. in acc. with IEC	315 A (gL/gG)
Immunity to short-circuiting (with max. backup fuse) $I_p$	25 kA
General data	
Dimensions W / H / D	142.8 mm / 95.8 mm / 70 mm
Connection data solid / stranded / AWG	2.5 ... 35 mm <sup>2</sup> / 2.5 ... 25 mm <sup>2</sup> / 13 - 2
Temperature range	-40 °C ... 80 °C
Inflammability class in acc. with UL 94	V0
Test standards	IEC 61643-1 / EN 61643-11 / UL 1449
Remote indication contact	PDT
Connection data solid / stranded / AWG	0.14 ... 1.5 mm <sup>2</sup> / 0.14 ... 1.5 mm <sup>2</sup> / 28 - 16
Max. operating voltage	250 V AC / 125 V DC
Max. operating current	1 A AC / 200 mA DC

Technical data		
I + II / T1 + T2		
240 V AC (230/400 V AC ... 240/415 V AC)		
- / - / 350 V AC		
75 kA (3-pos.) 37.5 As 1.40 MJ/Ω		
- / - / 75 kA (all channels)		
- / - / 25 kA (264 V AC)		
- / - / $\leq 1.5$ kV		
- / - / $\leq 25$ ns		
315 A (gL / gG) 25 kA		
General data		
142.8 mm / 95.8 mm / 70 mm		
2.5 ... 35 mm <sup>2</sup> / 2.5 ... 25 mm <sup>2</sup> / 13 - 2		
-40 °C ... 80 °C		
V0		
IEC 61643-1 / EN 61643-11 / UL 1449		
PDT		
0.14 ... 1.5 mm <sup>2</sup> / 0.14 ... 1.5 mm <sup>2</sup> / 28 - 16		
250 V AC / 125 V DC		
1 A AC / 200 mA DC		

Technical data		
I + II / T1 + T2		
240 V AC (230/400 V AC ... 240/415 V AC)		
- / - / 350 V AC		
75 kA (3-pos.) 37.5 As 1.40 MJ/Ω		
- / - / 75 kA (all channels)		
- / - / 25 kA (264 V AC)		
- / - / $\leq 1.5$ kV		
- / - / $\leq 25$ ns		
315 A (gL / gG) 25 kA		
General data		
106.9 mm / 95.8 mm / 70 mm		
2.5 ... 35 mm <sup>2</sup> / 2.5 ... 25 mm <sup>2</sup> / 13 - 2		
-40 °C ... 80 °C		
V0		
IEC 61643-1 / EN 61643-11 / UL 1449		
PDT		
0.14 ... 1.5 mm <sup>2</sup> / 0.14 ... 1.5 mm <sup>2</sup> / 28 - 16		
250 V AC / 125 V DC		
1 A AC / 200 mA DC		

Ordering data	
Description	FLASHTRAB compact

Type	Order No.	Pcs. / Pkt.
FLT-CP-3S-350	2859712	1

Type	Order No.	Pcs. / Pkt.
FLT-CP-3C-350	2859725	1

Accessories	
Replacement connector	L-N / L-PEN N-PE L-N / L-PEN

Accessories	Order No.	Quantity
FLT-CP-350-ST	2881887	10
FLT-CP-N/PE-350-ST	2859686	10
VAL-CP-350-ST	2859602	10

Accessories	Order No.	Quantity
FLT-CP-350-ST	2881887	10
VAL-CP-350-ST	2859602	10

Labeling material

ZBN 18 ..., see page 63

ZBN 18 ..., see page 63



4-conductor system; L1, L2, N, PE



3-conductor system; L1, L2, PEN



3-conductor system; L, N, PE

Total width 106.9 mm

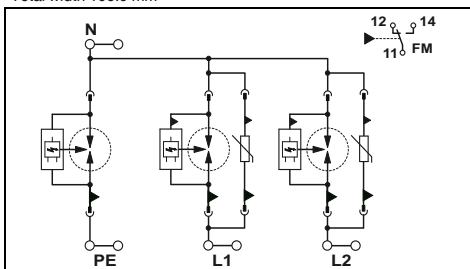

### Technical data

I + II / T1 + T2  
240 V AC (230/400 V AC ... 240/415 V AC)  
  
350 V AC / 350 V AC / -  
  
75 kA  
37.5 As  
1.40 MJ/Ω  
  
25 kA / 100 kA / -  
  
25 kA (264 V AC) / 100 A / -  
  
≤ 1.5 kV / ≤ 1.5 kV / -  
  
≤ 25 ns / ≤ 100 ns / -  
315 A (gL/gG)  
25 kA

106.9 mm / 95.8 mm / 70 mm  
2.5 ... 35 mm<sup>2</sup> / 2.5 ... 25 mm<sup>2</sup> / 13 - 2  
-40 °C ... 80 °C  
V0  
IEC 61643-1 / EN 61643-11 / UL 1449  
PDT  
0.14 ... 1.5 mm<sup>2</sup> / 0.14 ... 1.5 mm<sup>2</sup> / 28 - 16  
250 V AC / 125 V DC  
1 A AC / 200 mA DC

### Ordering data

Type	Order No.	Pcs. / Pkt.
FLT-CP-2S-350	2859767	1

### Accessories

FLT-CP-350-ST	2881887	10
FLT-CP-N/PE-350-ST	2859686	10
VAL-CP-350-ST	2859602	10

ZBN 18 ..., see page 63

Total width 71.6 mm

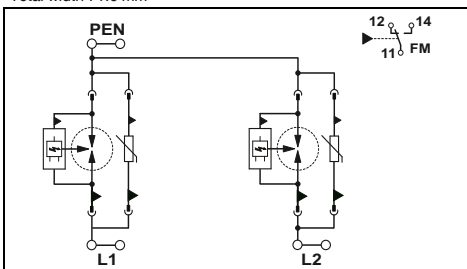

### Technical data

I + II / T1 + T2  
240 V AC (230/400 V AC ... 240/415 V AC)  
  
- / - / 350 V AC  
  
50 kA (2-pos.)  
25 As  
625.00 kJ/Ω  
  
- / - / 50 kA (all channels)  
  
- / - / 25 kA (264 V AC)  
  
- / - / ≤ 1.5 kV  
  
- / - / ≤ 25 ns  
315 A (gL / gG)  
25 kA

71.6 mm / 95.8 mm / 70 mm  
2.5 ... 35 mm<sup>2</sup> / 2.5 ... 25 mm<sup>2</sup> / 13 - 2  
-40 °C ... 80 °C  
V0  
IEC 61643-1 / EN 61643-11 / UL 1449  
PDT  
0.14 ... 1.5 mm<sup>2</sup> / 0.14 ... 1.5 mm<sup>2</sup> / 28 - 16  
250 V AC / 125 V DC  
1 A AC / 200 mA DC

### Ordering data

Type	Order No.	Pcs. / Pkt.
FLT-CP-2C-350	2859770	1

### Accessories

FLT-CP-350-ST	2881887	10
VAL-CP-350-ST	2859602	10

ZBN 18 ..., see page 63

Total width 71.6 mm

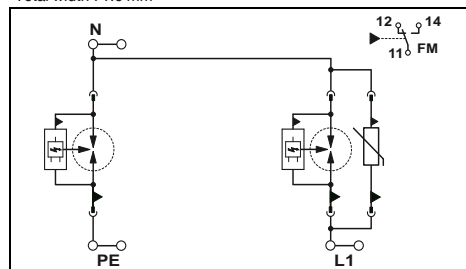

### Technical data

I + II / T1 + T2  
240 V AC (230 V AC ... 240 V AC)  
  
350 V AC / 350 V AC / -  
  
50 kA  
25 As  
625.00 kJ/Ω  
  
25 kA / 100 kA / -  
  
25 kA (264 V AC) / 100 A / -  
  
≤ 1.5 kV / ≤ 1.5 kV / -  
  
≤ 25 ns / ≤ 100 ns / -  
315 A (gL/gG)  
25 kA

71.6 mm / 95.8 mm / 70 mm  
2.5 ... 35 mm<sup>2</sup> / 2.5 ... 25 mm<sup>2</sup> / 13 - 2  
-40 °C ... 80 °C  
V0  
IEC 61643-1 / EN 61643-11 / UL 1449  
PDT  
0.14 ... 1.5 mm<sup>2</sup> / 0.14 ... 1.5 mm<sup>2</sup> / 28 - 16  
250 V AC / 125 V DC  
1 A AC / 200 mA DC

### Ordering data

Type	Order No.	Pcs. / Pkt.
FLT-CP-1S-350	2859738	1

### Accessories

FLT-CP-350-ST	2881887	10
FLT-CP-N/PE-350-ST	2859686	10
VAL-CP-350-ST	2859602	10

ZBN 18 ..., see page 63

# Surge protection and interference filters

## Surge protection for the power supply unit

### Type 1+2 lightning/surge arrester combination FLASHTRAB compact

- Seamless pluggability (even for N/PE spark gap)
- Thermal disconnect device for each individual connector
- Optical, mechanical status indication for the individual arresters
- With floating remote indication contact
- Connectors can be checked with CHECKMASTER
- High continuous voltage of 350 V AC for 230/400 V AC networks with high voltage fluctuations

**Notes:**  
For certifications, see page 154



2-conductor system; L, PEN

Total width 35.8 mm

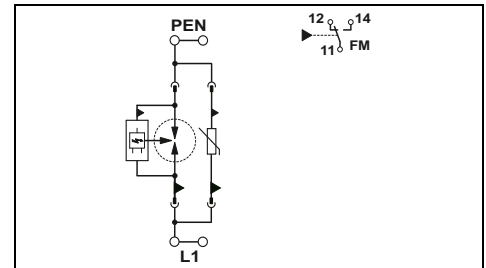

#### Technical data

Electrical data		Technical data	
IEC category / EN type		I + II / T1 + T2	
Nominal voltage $U_N$		240 V AC (230 V AC ... 240 V AC)	
Maximum continuous operating voltage $U_C$		L-N / N-PE / L-PEN 350 V AC / - / 350 V AC	
Lightning test curr. $I_{mp}$ (10/350) $\mu$ s		Peak value	25 kA
		Charge	12.5 As
		Specific energy	160.00 kJ/ $\Omega$
Nominal discharge surge current $I_n$ (8/20) $\mu$ s		L-N / N-PE / L-PEN 25 kA / - / 25 kA	
Follow current quenching capacity $I_{fi}$		L-N / N-PE / L-PEN 25 kA (264 V AC) / - / 25 kA (264 V AC)	
Protection level $U_p$		L-N / N-PE / L-PEN $\leq 1.5$ kV / - / $\leq 1.5$ kV	
Response time $t_A$		L-N / N-PE / L-PEN $\leq 25$ ns / - / $\leq 25$ ns	
Backup fuse max. in acc. with IEC		315 A (gL / gG)	
Immunity to short-circuiting (with max. backup fuse) $I_p$		25 kA	
General data			
Dimensions W / H / D		35.8 mm / 95.8 mm / 70 mm	
Connection data solid / stranded / AWG		2.5 ... 35 mm <sup>2</sup> / 2.5 ... 25 mm <sup>2</sup> / 13 - 2	
Temperature range		-40 °C ... 80 °C	
Inflammability class in acc. with UL 94		V0	
Test standards		IEC 61643-1 / EN 61643-11 / UL 1449	
Remote indication contact		PDT	
Connection data solid / stranded / AWG		0.14 ... 1.5 mm <sup>2</sup> / 0.14 ... 1.5 mm <sup>2</sup> / 28 - 16	
Max. operating voltage		250 V AC / 125 V DC	
Max. operating current		1 A AC / 200 mA DC	

#### Ordering data

Type	Order No.	Pcs. / Pkt.
FLT-CP-1C-350	2859741	1

#### Accessories

FLT-CP-350-ST	2881887	10
VAL-CP-350-ST	2859602	10

Description	
<b>FLASHTRAB compact</b> 1-pos.	
Replacement connector	
L-N / L-PEN	N-PE
L-N / L-PEN	L-PEN
Labeling material	
ZBN 18 ..., see page 63	





**N-PE spark gap,  
for Lightning Protection Level 1**

Total width 35.8 mm

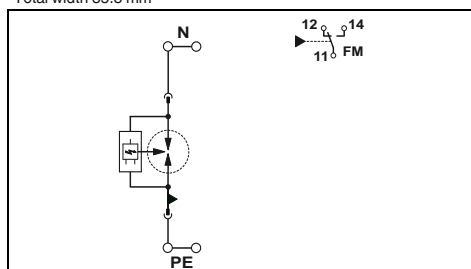

### Technical data

I / T1  
240 V AC (N-PE)

- / 350 V AC / -

100 kA  
50 As  
2.50 MJ/Ω

- / 100 kA / -

- / 100 A / -

- / ≤ 1.5 kV / -

- / ≤ 100 ns / -

-  
25 kA

35.8 mm / 95.8 mm / 70 mm

2.5 ... 35 mm<sup>2</sup> / 2.5 ... 25 mm<sup>2</sup> / 13 - 2

-40 °C ... 80 °C

V0

IEC 61643-1 / EN 61643-11 / EN 61643-11/A11 /

UL 1449

PDT

0.14 ... 1.5 mm<sup>2</sup> / 0.14 ... 1.5 mm<sup>2</sup> / 28 - 16

250 V AC / 125 V DC

1 A AC / 200 mA DC

### Ordering data

Type	Order No.	Pcs. / Pkt.
FLT-CP-N/PE-350	2859754	1

### Accessories

FLT-CP-N/PE-350-ST	2859686	10
--------------------	---------	----

ZBN 18 ..., see page 63

# Surge protection and interference filters

## Surge protection for the power supply unit

### Type 2 surge arresters VALVETRAB compact

- Type 2 seamless plug-in surge arrester
- Disconnect device on each individual connector
- Optical, mechanical status indication for the individual arresters
- With or without floating remote indication contact
- Mechanical keying of all slots
- Modular arrester blocks with ultra-slim design
- Use of varistors that are free of leakage current
- Connectors can be checked with CHECKMASTER
- High continuous voltage of 350 V AC for 230/400 V AC networks with high voltage fluctuations

**Notes:**  
For certifications, see page 154



5-conductor system; L1, L2, L3, N, PE



4-conductor system; L1, L2, L3, PEN

Total width 49.2 mm

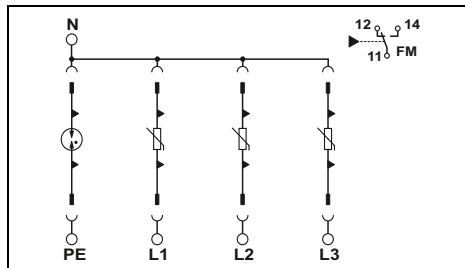

Total width 37.25 mm

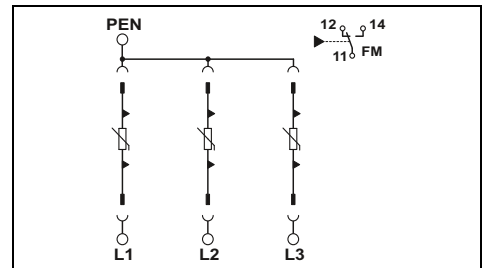

#### Technical data

Electrical data	... 350	... 175
IEC category / EN type	II / T2	II / T2
Nominal voltage $U_N$	240 V AC (230/400 V AC ... 240/415 V AC)	120 V AC
Maximum continuous operating voltage $U_c$	L-N / N-PE / L-PEN 350 V AC / 264 V AC / -	175 V AC / 150 V AC / -
Nominal discharge surge current $I_n$ (8/20) $\mu$ s	L-N / N-PE / L-PEN 20 kA / 20 kA / -	60 kA (all channels) / 20 kA / -
Max. discharge surge current $I_{max}$ (8/20) $\mu$ s	L-N / N-PE / L-PEN 120 kA (all channels) / 40 kA / - L-N / N-PE / L-PEN $\leq 1.1$ kV / $\leq 0.25$ kV / -	120 kA (all channels) / 40 kA / - L-N / N-PE / L-PEN $\leq 600$ V / $\leq 200$ V / -
Residual voltage at 5 kA	L-N / N-PE / L-PEN $\leq 1.4$ kV / $\leq 1.5$ kV / -	$\leq 850$ V / $\leq 950$ V / -
Protection level $U_p$	L-N / N-PE / L-PEN $\leq 1.4$ kV / $\leq 1.5$ kV / -	$\leq 850$ V / $\leq 950$ V / -
Response time $t_A$	L-N / N-PE / L-PEN $\leq 25$ ns / $\leq 100$ ns / -	$\leq 25$ ns / $\leq 100$ ns / -
Backup fuse max. in acc. with IEC	125 A (gL/gG)	125 A (gL/gG)
General data	49.2 mm / 98.5 mm / 70 mm	
Dimensions W / H / D	2.5 ... 25 mm <sup>2</sup> / 2.5 ... 16 mm <sup>2</sup> / 12 - 4	
Connection data solid / stranded / AWG	-40 °C ... 80 °C	
Temperature range	V0	
Inflammability class in acc. with UL 94	IEC 61643-1 / DIN EN 61643-11 / DIN EN 61643-11/A11 / IEEE C62.1 / C62.34 / C62.45 / UL 1449	
Test standards	PDT, 1-pos.	
Remote indication contact	0.14 ... 1.5 mm <sup>2</sup> / 0.14 ... 1.5 mm <sup>2</sup> / 28 - 16	
Connection data solid / stranded / AWG	250 V AC / 125 V DC	
Max. operating voltage	1 A AC (ohmic) / 200 mA DC (ohmic)	
Max. operating current		

#### Technical data

Electrical data	... 350	... 175
IEC category / EN type	II / T2	II / T2
Nominal voltage $U_N$	240 V AC (230/400 V AC ... 240/415 V AC)	120 V AC (3P/PEN)
Maximum continuous operating voltage $U_c$	- / - / 350 V AC	- / - / 175 V AC
Nominal discharge surge current $I_n$ (8/20) $\mu$ s	- / - / 60 kA (all channels)	- / - / 60 kA (all channels)
Max. discharge surge current $I_{max}$ (8/20) $\mu$ s	- / - / 120 kA (all channels) - / - / $\leq 1.1$ kV	- / - / 120 kA (all channels) - / - / $\leq 600$ V
Residual voltage at 5 kA	- / - / $\leq 1.4$ kV	- / - / $\leq 850$ V (at In)
Protection level $U_p$	- / - / $\leq 1.4$ kV	- / - / $\leq 850$ V (at In)
Response time $t_A$	- / - / $\leq 25$ ns	- / - / $\leq 25$ ns
Backup fuse max. in acc. with IEC	125 A (gL/gG)	125 A (gL/gG)
General data	37.25 mm / 98.5 mm / 70 mm	
Dimensions W / H / D	2.5 ... 25 mm <sup>2</sup> / 2.5 ... 16 mm <sup>2</sup> / 12 - 4	
Connection data solid / stranded / AWG	-40 °C ... 80 °C	
Temperature range	V0	
Inflammability class in acc. with UL 94	IEC 61643-1 / DIN EN 61643-11 / UL 1449 / IEEE C62.1 / C62.34 / C62.45	
Test standards	PDT	
Remote indication contact	0.14 ... 1.5 mm <sup>2</sup> / 0.14 ... 1.5 mm <sup>2</sup> / 28 - 16	
Connection data solid / stranded / AWG	250 V AC / 125 V DC	
Max. operating voltage	1 A AC (ohmic) / 200 mA DC (ohmic)	
Max. operating current		

#### Ordering data

Description	VALVETRAB compact
	with remote indication contact
	without remote indication contact
	with remote indication contact
	Bridge set, for bridging VALVETRAB compact to the r.c.c.b.

Type	Order No.	Pcs. / Pkt.
VAL-CP-3S-350	2859521	1
VAL-CP-3S-350/O	2881010	1
VAL-CP-3S-175	2859453	1
MPB SET VAL-CP-3S	2880684	1

#### Ordering data

Type	Order No.	Pcs. / Pkt.
VAL-CP-3C-350	2859547	1
VAL-CP-3C-350/O	2881023	1
VAL-CP-3C-175	2859466	1

#### Accessories

Replacement connector	L-N / L-PEN	VAL-CP-350-ST	2859602	10
	N-PE	VAL-CP-N/PE-350-ST	2859699	10
	L-N / L-PEN	VAL-CP-175-ST	2859628	10

Labeling material	ZBFM 5 ..., see page 63
-------------------	-------------------------

#### Accessories

Replacement connector	L-N / L-PEN	VAL-CP-350-ST	2859602	10
	N-PE	VAL-CP-N/PE-350-ST	2859699	10
	L-N / L-PEN	VAL-CP-175-ST	2859628	10

Labeling material	ZBFM 5 ..., see page 63
-------------------	-------------------------



4-conductor system; L1, L2, N, PE



3-conductor system; L1, L2, PEN



3-conductor system; L, N, PE

Total width 37.25 mm

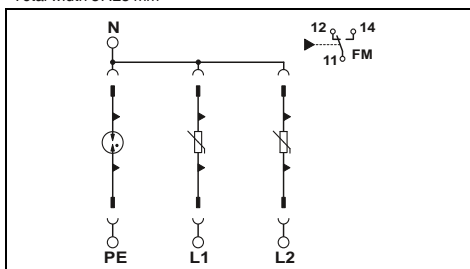

Total width 25.3 mm

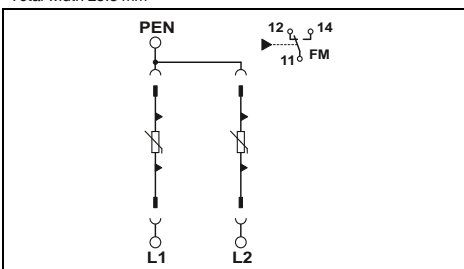

Total width 25.3 mm

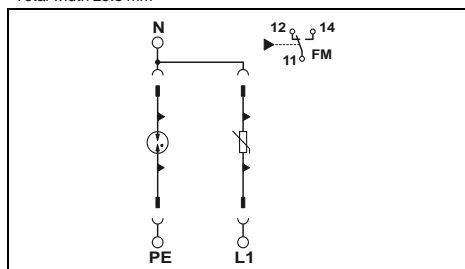

### Technical data

... 350	... 175
II / T2	II / T2
240 V AC (230/400 V AC ...)	120 V AC
240/415 V AC)	
350 V AC / 264 V AC / -	175 V AC / 150 V AC / -
40 kA (all channels) / 20 kA / -	40 kA (all channels) / 20 kA / -
80 kA (all channels) / 40 kA / -	80 kA (all channels) / 40 kA / -
≤ 1.1 kV / ≤ 0.25 kV / -	≤ 600 V / ≤ 200 V / -
≤ 1.4 kV / ≤ 1.5 kV / -	≤ 850 V / ≤ 950 V / -
≤ 25 ns / ≤ 100 ns / -	≤ 25 ns / ≤ 100 ns / -
125 A (gL/gG)	125 A (gL/gG)

37.25 mm / 98.5 mm / 70 mm  
2.5 ... 25 mm<sup>2</sup> / 2.5 ... 16 mm<sup>2</sup> / 12 - 4  
-40 °C ... 80 °C

IEC 61643-1 / DIN EN 61643-11 / DIN EN 61643-11/A11 /  
IEEE C62.1 / C62.34 / C62.45 / UL 1449

PDT

0.14 ... 1.5 mm<sup>2</sup> / 0.14 ... 1.5 mm<sup>2</sup> / 28 - 16  
250 V AC / 125 V DC  
1 A AC (ohmic) / 200 mA DC (ohmic)

### Technical data

... 350	... 175
II / T2	II / T2
240 V AC (230/400 V AC ...)	120 V AC (2P/PEN)
240/415 V AC)	
- / - / 350 V AC	- / - / 175 V AC
- / - / 40 kA (all channels)	- / - / 40 kA (all channels)
- / - / 80 kA (all channels)	- / - / 80 kA (all channels)
- / - / ≤ 1.1 kV	- / - / ≤ 600 V
- / - / ≤ 1.4 kV	- / - / ≤ 850 V (at In)
- / - / ≤ 25 ns	- / - / ≤ 25 ns
125 A (gL/gG)	125 A (gL/gG)

25.3 mm / 98.5 mm / 70 mm  
2.5 ... 25 mm<sup>2</sup> / 2.5 ... 16 mm<sup>2</sup> / 12 - 4  
-40 °C ... 80 °C

IEC 61643-1 / DIN EN 61643-11 / UL 1449 /  
IEEE C62.1 / C62.34 / C62.45

PDT

0.14 ... 1.5 mm<sup>2</sup> / 0.14 ... 1.5 mm<sup>2</sup> / 28 - 16  
250 V AC / 125 V DC  
1 A AC (ohmic) / 200 mA DC (ohmic)

### Technical data

... 350	... 175
II / T2	II / T2
240 V AC (230/400 V AC ...)	120 V AC
240/415 V AC)	
350 V AC / 264 V AC / -	175 V AC / 150 V AC / -
20 kA / 20 kA / -	20 kA / 20 kA / -
40 kA / 40 kA / -	40 kA / 40 kA / -
≤ 1.1 kV / ≤ 0.25 kV / -	≤ 600 V / ≤ 200 V / -
≤ 1.4 kV / ≤ 1.5 kV / -	≤ 850 V / ≤ 950 V / -
≤ 25 ns / ≤ 100 ns / -	≤ 25 ns / ≤ 100 ns / -
125 A (gL/gG)	125 A (gL/gG)

25.3 mm / 98.5 mm / 70 mm  
2.5 ... 25 mm<sup>2</sup> / 2.5 ... 16 mm<sup>2</sup> / 12 - 4  
-40 °C ... 80 °C

IEC 61643-1 / DIN EN 61643-11 / DIN EN 61643-11/A11 /  
IEEE C62.1 / C62.34 / C62.45 / UL 1449

PDT

0.14 ... 1.5 mm<sup>2</sup> / 0.14 ... 1.5 mm<sup>2</sup> / 28 - 16  
250 V AC / 125 V DC  
1 A AC (ohmic) / 200 mA DC (ohmic)

### Ordering data

Type	Order No.	Pcs. / Pkt.
VAL-CP-2S-350	2859505	1
VAL-CP-2S-350/O	2881049	1
VAL-CP-2S-175	2859495	1

### Accessories

VAL-CP-350-ST	2859602	10
VAL-CP-N/PE-350-ST	2859699	10
VAL-CP-175-ST	2859628	10

ZBFM 5 ..., see page 63

### Ordering data

Type	Order No.	Pcs. / Pkt.
VAL-CP-2C-350	2859589	1
VAL-CP-2C-350/O	2881052	1
VAL-CP-2C-175	2859482	1

### Accessories

VAL-CP-350-ST	2859602	10
VAL-CP-175-ST	2859628	10

ZBFM 5 ..., see page 63

### Ordering data

Type	Order No.	Pcs. / Pkt.
VAL-CP-1S-350	2859563	1
VAL-CP-N/PE-350/O	2881036	1
VAL-CP-1S-175	2859479	1

### Accessories

VAL-CP-350-ST	2859602	10
VAL-CP-N/PE-350-ST	2859699	10
VAL-CP-175-ST	2859628	10

ZBFM 5 ..., see page 63

# Surge protection and interference filters

## Surge protection for the power supply unit

### Type 2 surge arresters

#### VALVETRAB MS

#### 30/40 kA performance class

- Multi-channel type 2 arrester
- Type 2 seamless plug-in surge arrester
- Disconnect device on each individual connector
- Optical, mechanical status indication for the individual arresters
- With or without floating remote indication contact
- Mechanical keying of all slots



5-conductor system; L1, L2, L3, N, PE, supply line supply from below



5-conductor system; L1, L2, L3, N, PE, supply line supply from above

**Notes:**  
For certifications, see page 154

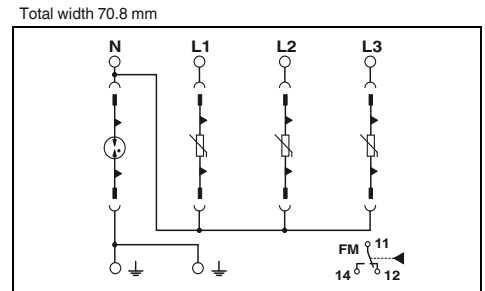
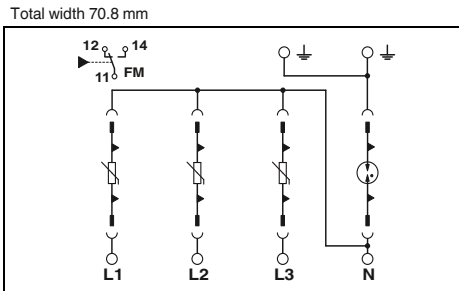

Electrical data	
IEC category / EN type	II / T2
Nominal voltage $U_N$	230 V AC (400 V AC)
Maximum continuous operating voltage $U_c$	L-N / N-PE / L-PEN 275 V AC / 260 V AC / -
Nominal discharge surge current $I_n$ (8/20) $\mu$ s	L-N / N-PE / L-PEN 20 kA / 20 kA / -
Max. discharge surge current $I_{max}$ (8/20) $\mu$ s	L-N / N-PE / L-PEN 40 kA / 40 kA / -
Residual voltage at 5 kA	L-N / N-PE / L-PEN $\leq 1.1$ kV / $\leq 0.15$ kV / -
Protection level $U_p$	L-N / N-PE / L-PEN $\leq 1.35$ kV / $\leq 1.5$ kV / -
Response time $t_A$	L-N / N-PE / L-PEN $\leq 25$ ns / $\leq 100$ ns / -
Backup fuse max. in acc. with IEC	125 A (gL)
Immunity to short-circuiting (with max. backup fuse) $I_p$	25 kA
General data	
Dimensions W / H / D	70.8 mm / 96.8 mm / 65.5 mm
Connection data solid / stranded / AWG	0.5 ... 35 mm <sup>2</sup> / 0.5 ... 25 mm <sup>2</sup> / 20 - 2
Temperature range	-40 °C ... 80 °C
Inflammability class in acc. with UL 94	V0
Test standards	IEC 61643-1 / EN 61643-11/A11
Remote indication contact	
Connection data solid / stranded / AWG	0.14 ... 1.5 mm <sup>2</sup> / 0.14 ... 1.5 mm <sup>2</sup> / 28 - 16
Max. operating voltage	250 V AC / 30 V DC
Max. operating current	0.75 A AC (250 V AC) / 1 A DC (30 V DC)

Technical data	
VAL-MS 230	VAL-MS 320
II / T2	II / T2
230 V AC (400 V AC)	230 V AC (400 V AC)
275 V AC / 260 V AC / -	335 V AC / 260 V AC / -
20 kA / 20 kA / -	20 kA / 20 kA / -
40 kA / 40 kA / -	40 kA / 40 kA / -
$\leq 1.1$ kV / $\leq 0.15$ kV / -	$\leq 1.25$ kV / $\leq 0.15$ kV / -
$\leq 1.35$ kV / $\leq 1.5$ kV / -	$\leq 1.6$ kV / $\leq 1.5$ kV / -
$\leq 25$ ns / $\leq 100$ ns / -	$\leq 25$ ns / $\leq 100$ ns / -
	125 A (gL)
	25 kA

Technical data	
VAL-MS 320	
II / T2	
230 V AC (400 V AC)	
335 V AC / 260 V AC / -	
20 kA / 20 kA / -	
40 kA / 40 kA / -	
$\leq 1.25$ kV / $\leq 0.15$ kV / -	
$\leq 1.6$ kV / $\leq 1.5$ kV / -	
$\leq 25$ ns / $\leq 100$ ns / -	
	125 A (gL)
	25 kA

Ordering data		
Description	$I_{max}$	$U_c$
<b>VALVETRAB, multi-position surge arrester combination</b>		
without remote indication contact	40 kA	275 V AC
with remote indication contact	40 kA	275 V AC
without remote indication contact	40 kA	335 V AC
with remote indication contact	40 kA	335 V AC
<b>VALVETRAB MS</b>		
without remote indication contact	30 kA	580 V AC
with remote indication contact	30 kA	580 V AC

Ordering data		
Type	Order No.	Pcs. / Pkt.
VAL-MS 230/3+1	2838209	1
VAL-MS 230/3+1 FM	2838199	1
VAL-MS 320/3+1	2859178	1
VAL-MS 320/3+1/FM	2859181	1

Ordering data		
Type	Order No.	Pcs. / Pkt.
VAL-MS 320/3+1/FM-UD	2856689	1

Accessories	
Replacement connector	
1L-N/PE	
1L-N/PE	
1L-N/PE	
N-PE	

Accessories		
	Order No.	Pcs. / Pkt.
VAL-MS 230 ST	2798844	10
VAL-MS 320 ST	2838843	10
F-MS 12 ST	2817990	10

Accessories		
	Order No.	Pcs. / Pkt.
VAL-MS 320-UD ST	2858315	10
F-MS 12 ST	2817990	10

**Marking material**  
ZBN 18 ..., see page 63

**Marking material**  
ZBN 18 ..., see page 63



4-conductor system; L1, L2, L3, PEN



3-conductor system; L, N, PE



3-conductor system; L1, L2, PEN

Total width 53.4 mm

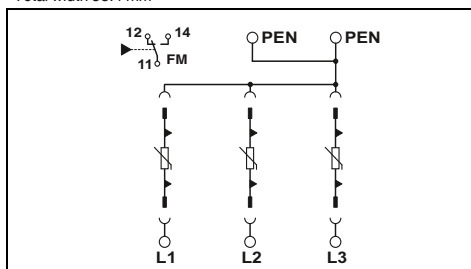

Total width 35.6 mm

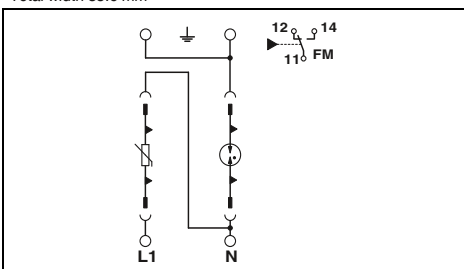

Total width 35.6 mm

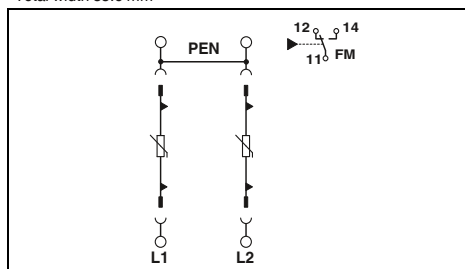

### Technical data

VAL-MS 320	VAL-MS 580
II / T2	II / T2
230 V AC (Max. 240/415 V AC)	400 V AC (400/690 V AC TN-C)
- / - / 335 V AC	- / - / 580 V AC
- / - / 60 kA (all channels)	- / - / 45 kA (all channels)
- / - / 120 kA (all channels)	- / - / 90 kA (all channels)
- / - / ≤ 1.2 kV	- / - / ≤ 2.1 kV
- / - / ≤ 1.5 kV	- / - / ≤ 2.5 kV
- / - / ≤ 25 ns	- / - / ≤ 25 ns
	125 A (gL / gG)
	25 kA

### Technical data

VAL-MS 230	VAL-MS 320
II / T2	II / T2
230 V AC	230 V AC
275 V AC / 260 V AC / -	335 V AC / 260 V AC / -
20 kA / 20 kA / -	20 kA / 20 kA / -
40 kA / 40 kA / -	40 kA / 40 kA / -
≤ 1.1 kV / ≤ 150 V / -	- 1.2 kV / ≤ 150 V / -
≤ 1.35 kV / ≤ 1.5 kV / -	≤ 1.5 kV / ≤ 1.5 kV / -
≤ 25 ns / ≤ 100 ns / -	≤ 25 ns / ≤ 100 ns / -
	125 A (gL/gG)
	25 kA

### Technical data

VAL-MS 230
II / T2
230 V AC (400 V AC)
- / - / 275 V AC
- / - / 40 kA (all channels)
- / - / 80 kA (all channels)
- / - / ≤ 1.1 kV
- / - / ≤ 1.35 kV
- / - / ≤ 25 ns
125 A (gL/gG)
25 kA

53.4 mm / 99 mm / 65.5 mm  
1.5 ... 35 mm<sup>2</sup> / 1.5 ... 25 mm<sup>2</sup> / 15 - 2  
-40 °C ... 80 °C  
V0

IEC 61643-1 / EN 61643-11

PDT

0.14 ... 1.5 mm<sup>2</sup> / 0.14 ... 1.5 mm<sup>2</sup> / 28 - 16

250 V AC / 30 V DC

1.5 A AC (250 V AC) / 1 A DC (30 V DC)

35.6 mm / 97 mm / 65.5 mm  
1.5 ... 35 mm<sup>2</sup> / 1.5 ... 25 mm<sup>2</sup> / 15 - 2  
-40 °C ... 80 °C  
V0

IEC 61643-1 / EN 61643-11/A11

PDT, 1-pos.

0.14 ... 1.5 mm<sup>2</sup> / 0.14 ... 1.5 mm<sup>2</sup> / 28 - 16

250 V AC / 30 V DC

1.5 A AC (250 V AC) / 1 A DC (30 V DC)

35.6 mm / 97 mm / 65.5 mm  
1.5 ... 35 mm<sup>2</sup> / 1.5 ... 25 mm<sup>2</sup> / 15 - 2  
-40 °C ... 80 °C  
V0

IEC 61643-1 / EN 61643-11/A11

PDT, 1-pos.

0.14 ... 1.5 mm<sup>2</sup> / 0.14 ... 1.5 mm<sup>2</sup> / 28 - 16

250 V AC / 30 V DC

1.5 A AC (250 V AC) / 1 A DC (30 V DC)

### Ordering data

Type	Order No.	Pcs. / Pkt.
VAL-MS 320/3+0	2920230	1
VAL-MS 320/3+0-FM	2920243	1
VAL-MS 580/3+0	2920450	1
VAL-MS 580/3+0-FM	2920447	1

### Ordering data

Type	Order No.	Pcs. / Pkt.
VAL-MS 230/1+1	2804429	1
VAL-MS 230/1+1-FM	2804432	1
VAL-MS 320/1+1	2804380	1
VAL-MS 320/1+1-FM	2804393	1

### Ordering data

Type	Order No.	Pcs. / Pkt.
VAL-MS 230/2+0	2800103	1
VAL-MS 230/2+0-FM	2800102	1

### Accessories

Accessories	Order No.	Pcs. / Pkt.
VAL-MS 320 ST	2838843	10
VAL-MS 580-ST	2920434	10

### Accessories

Accessories	Order No.	Pcs. / Pkt.
VAL-MS 230 ST	2798844	10
VAL-MS 320 ST	2838843	10
F-MS 12 ST	2817990	10

### Accessories

Accessories	Order No.	Pcs. / Pkt.
VAL-MS 230 ST	2798844	10

ZBN 18 ..., see page 63

ZBN 18 ..., see page 63

ZBN 18 ..., see page 63

# Surge protection and interference filters

## Surge protection for the power supply unit

### Type 2 surge arresters VALVETRAB MS

- Single-channel, DIN-rail mountable protective devices
- Comprising base element and connector
- Base element with/without floating remote indication contact
- Disconnect device on each individual connector
- Optical, mechanical status indication for the individual arresters
- Mechanical keying of all slots

<b>Notes:</b>
For certifications, see page 154



2-conductor system; L, N/PEN

Total width 17.7 mm

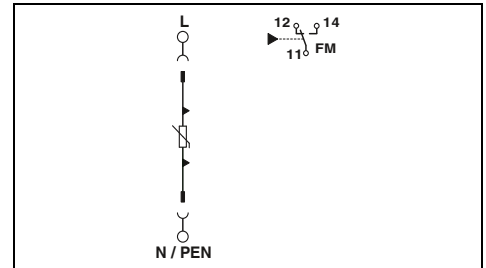

<b>Electrical data</b>	... 60AC	... 230AC
IEC category / EN type	II / T2	II / T2
Nominal voltage $U_N$	60 V AC/DC	230 V AC
Maximum continuous operating voltage $U_C$	L-N / N-PE / L-PEN 75 V AC / - / 75 V AC	275 V AC / - / 275 V AC
Nominal discharge surge current $I_n$ (8/20) $\mu$ s	L-N / N-PE / L-PEN 15 kA / - / -	20 kA / - / 20 kA
Max. discharge surge current $I_{max}$ (8/20) $\mu$ s	L-N / N-PE / L-PEN 40 kA / - / 40 kA	40 kA / - / 40 kA
Residual voltage at 5 kA	L-N / N-PE / L-PEN $\leq 325$ V / - / $\leq 325$ V	$\leq 1$ kV / - / $\leq 1$ kV
Protection level $U_p$	L-N / N-PE / L-PEN $\leq 500$ V / - / $\leq 500$ V	$\leq 1.35$ kV / - / $\leq 1.35$ kV
Response time $t_A$	L-N / N-PE / L-PEN $\leq 25$ ns / - / $\leq 25$ ns	$\leq 25$ ns / - / $\leq 25$ ns
Backup fuse max. in acc. with IEC	125 A (gL/gG)	
<b>General data</b>		
Dimensions W / H / D	17.7 mm / - / 96.8 mm	
Connection data solid / stranded / AWG	1.5 ... 35 mm <sup>2</sup> / 1.5 ... 25 mm <sup>2</sup> / 15 - 2	
Temperature range	-40 °C ... 80 °C	
Inflammability class in acc. with UL 94	V0	
Test standards	IEC 61643-1 / EN 61643-11/A11	
<b>Remote indication contact</b>	PDT, 1-pos.	
Connection data solid / stranded / AWG	0.14 ... 1.5 mm <sup>2</sup> / 0.14 ... 1.5 mm <sup>2</sup> / 28 - 16	
Max. operating voltage	250 V AC / 30 V DC	
Max. operating current	1 A AC / 1 A DC	

<b>Description</b>
<b>VALVETRAB MS</b>
with remote indication contact
without remote indication contact
with remote indication contact
without remote indication contact

Technical data		
... 60AC	... 230AC	
II / T2	II / T2	
60 V AC/DC	230 V AC	
L-N / N-PE / L-PEN 75 V AC / - / 75 V AC	275 V AC / - / 275 V AC	
L-N / N-PE / L-PEN 15 kA / - / -	20 kA / - / 20 kA	
L-N / N-PE / L-PEN 40 kA / - / 40 kA	40 kA / - / 40 kA	
L-N / N-PE / L-PEN $\leq 325$ V / - / $\leq 325$ V	$\leq 1$ kV / - / $\leq 1$ kV	
L-N / N-PE / L-PEN $\leq 500$ V / - / $\leq 500$ V	$\leq 1.35$ kV / - / $\leq 1.35$ kV	
L-N / N-PE / L-PEN $\leq 25$ ns / - / $\leq 25$ ns	$\leq 25$ ns / - / $\leq 25$ ns	
125 A (gL/gG)		
17.7 mm / - / 96.8 mm		
1.5 ... 35 mm <sup>2</sup> / 1.5 ... 25 mm <sup>2</sup> / 15 - 2		
-40 °C ... 80 °C		
V0		
IEC 61643-1 / EN 61643-11/A11		
PDT, 1-pos.		
0.14 ... 1.5 mm <sup>2</sup> / 0.14 ... 1.5 mm <sup>2</sup> / 28 - 16		
250 V AC / 30 V DC		
1 A AC / 1 A DC		

<b>Replacement connector</b>	1L-N/PE
	1L-N/PE
<b>VALVETRAB</b> , single-position base element	
with remote indication contact	
without remote indication contact	

Ordering data		
Type	Order No.	Pcs. / Pkt.
VAL-MS 60/FM	2868033	1
VAL-MS 60	2868020	1
VAL-MS 230/FM	2839130	1
VAL-MS 230	2839127	1

Accessories		
VAL-MS 60 ST	2807573	10
VAL-MS 230 ST	2798844	10
VAL-MS BE/FM	2817738	10
VAL-MS BE	2817741	10

<b>Labeling material</b>	ZBN 18 ..., see page 63
--------------------------	-------------------------

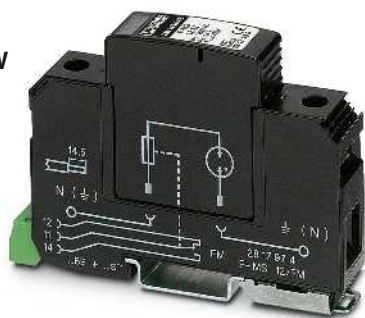

**Spark gap, N-PE**

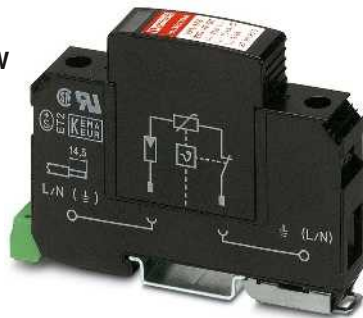

**2-conductor system; L, N/PEN**

Total width 17.7 mm

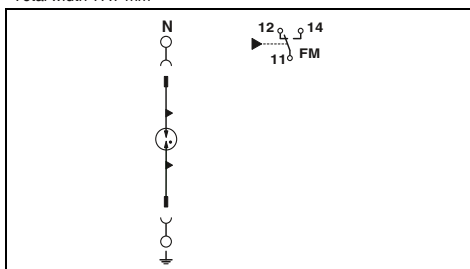

**Technical data**

F-MS 12  
II / T2  
230 V AC  
  
- / 260 V AC / -  
  
- / 20 kA / -  
  
- / 40 kA / -  
- / ≤ 150 V / -  
  
- / ≤ 1.5 kV / -  
  
- / ≤ 100 ns / -  
-

17.7 mm / - / 96.8 mm  
0.5 ... 35 mm<sup>2</sup> / 0.5 ... 25 mm<sup>2</sup> / 20 - 2  
-40 °C ... 80 °C  
V0  
IEC 61643-1 / EN 61643-11/A11

PDT  
0.14 ... 1.5 mm<sup>2</sup> / 0.14 ... 1.5 mm<sup>2</sup> / 28 - 16  
250 V AC / 30 V DC  
1 A AC / 1 A DC

**Ordering data**

Type	Order No.	Pcs. / Pkt.
F-MS 12/FM	2817974	1
F-MS 12	2817987	1

**Accessories**

F-MS 12 ST	2817990	10
VAL-MS BE/FM	2817738	10
VAL-MS BE	2817741	10

ZBN 18 ..., see page 63

Total width 17.7 mm

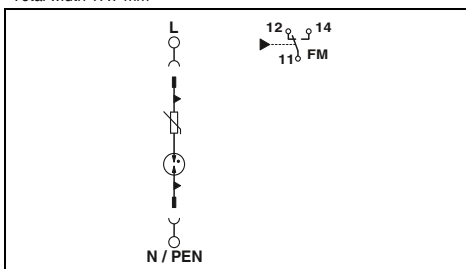

**Technical data**

VAL-MS 350 VF  
II / T2  
230 V AC  
  
350 V AC / - / 350 V AC  
  
10 kA / - / 10 kA  
  
20 kA / - / 20 kA  
≤ 1 kV / - / ≤ 1 kV  
  
≤ 1.5 kV / - / ≤ 1.5 kV  
  
≤ 100 ns / - / ≤ 100 ns  
125 A (gL)

17.7 mm / - / 96.8 mm  
0.5 ... 35 mm<sup>2</sup> / 0.5 ... 25 mm<sup>2</sup> / 20 - 2  
-40 °C ... 80 °C  
-

IEC 61643-1 / EN 61643-11/A11 / NF C61-740 / UL 1449

PDT  
0.14 ... 1.5 mm<sup>2</sup> / 0.14 ... 1.5 mm<sup>2</sup> / 28 - 16  
250 V AC / 30 V DC  
1 A AC / 1 A DC

**Ordering data**

Type	Order No.	Pcs. / Pkt.
VAL-MS 350 VF/FM	2856579	1
VAL-MS 350VF	2856582	1

**Accessories**

VAL-MS 350 VF ST	2856595	10
VAL-MS BE/FM	2817738	10
VAL-MS BE	2817741	10

ZBN 18 ..., see page 63

# Surge protection and interference filters

## Surge protection for the power supply unit

### Type 2 surge protection plug for VAL-MS base elements



- Thermal disconnect device for each individual connector
- Optical, mechanical status indication for all protective connectors
- Connectors can be checked with CHECKMASTER

<b>Notes:</b>
For certifications, see page 154
Please follow the installation instructions. These are provided with the packaging documentation or can be downloaded from the corresponding product page online at <a href="http://www.phoenixcontact.net/products">www.phoenixcontact.net/products</a> .
You can find a list of all possible combination options and safety notes in the download area for the corresponding replacement plug at <a href="http://www.phoenixcontact.net/products">www.phoenixcontact.net/products</a> .



Plug, 1-pos., L-N/L-PEN

Total width 17.7 mm

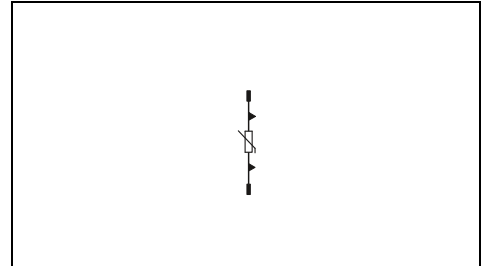

<b>Electrical data</b>
IEC category / EN type
Nominal voltage $U_N$
Maximum continuous operating voltage $U_C$
Nominal discharge surge current $I_n$ (8/20) $\mu$ s
Max. discharge surge current $I_{max}$ (8/20) $\mu$ s
Residual voltage at 5 kA
Protection level $U_p$
Response time $t_A$ :
Backup fuse max. in acc. with IEC
<b>General data</b>
Dimensions W / H / D
Temperature range
Degree of protection in acc. with IEC 60529/ EN 60529
Housing material
Inflammability class in acc. with UL 94
Test standards

Technical data			
... 120 ST	... 230 IT ST	... 400 ST	... 500 ST
II / T2	II / T2	II / T2	II / T2
120 V AC	230 V AC	400 V AC	500 V AC
150 V AC	385 V AC	440 V AC	600 V AC
20 kA	20 kA	20 kA	20 kA
40 kA	40 kA	40 kA	30 kA
$\leq 550$ V	$\leq 1.35$ kV	$\leq 1.5$ kV	$\leq 2.3$ kV
$\leq 800$ V	$\leq 1.8$ kV	$\leq 2.2$ kV	$\leq 2.7$ kV
$\leq 25$ ns	$\leq 25$ ns	$\leq 25$ ns	$\leq 25$ ns
125 A (gL)			
17.7 mm / 52.4 mm / 54.5 mm			
-40 °C ... 80 °C			
IP20			
PA			
V0			
IEC 61643-1 / EN 61643-11/A11 / UL 1449 / IEEE C62.1 / C62.34 / C62.45			

Description	Nominal voltage $U_N$
<b>VALVETRAB</b> surge protection plug	120 V AC
	230 V AC
	400 V AC
	500 V AC

Ordering data		
Type	Order No.	Pcs. / Pkt.
<b>VAL-MS 120 ST</b>	<b>2807586</b>	10
<b>VAL-MS 230 IT ST</b>	<b>2807599</b>	10
<b>VAL-MS 400 ST</b>	<b>2816399</b>	10
<b>VAL-MS 500 ST</b>	<b>2807609</b>	10

<b>VALVETRAB</b> , base element for 4-wire systems, L1, L2, L3, PEN, for individual assembly with VAL-MS...ST		
with remote indication contact	3L-PEN	
without remote indication contact	3L-PEN	
<b>VALVETRAB</b> , base element for 3-wire systems, L1, L2, PEN, for individual assembly with VAL-MS...ST		
with remote indication contact	2L-GND	
without remote indication contact	2L - PEN	
<b>VALVETRAB</b> , single-position base element		
with remote indication contact		
without remote indication contact		

Accessories		
<b>VAL-MS/3+0-BE/FM</b>	<b>2881803</b>	1
<b>VAL-MS/3+0-BE</b>	<b>2881816</b>	1
<b>VAL-MS/2+0-BE/FM</b>	<b>2805321</b>	1
<b>VAL-MS/2+0-BE</b>	<b>2804584</b>	1
<b>VAL-MS BE/FM</b>	<b>2817738</b>	10
<b>VAL-MS BE</b>	<b>2817741</b>	10



### Type 2 surge protection plug for VAL-MS base elements

- Specifically for use in American applications
- 1-pos.
- Thermal disconnect device for each individual connector
- Optical, mechanical status indication for all protective connectors
- Connectors can be checked with CHECKMASTER



Single-pos.



Single-pos.

<b>Notes:</b>
For certifications, see page 154
Please follow the installation instructions. These are provided with the packaging documentation or can be downloaded from the corresponding product page online at <a href="http://www.phoenixcontact.net/products">www.phoenixcontact.net/products</a> .
You can find a list of all possible combination options and safety notes in the download area for the corresponding replacement plug at <a href="http://www.phoenixcontact.net/products">www.phoenixcontact.net/products</a> .

Total width 17.7 mm

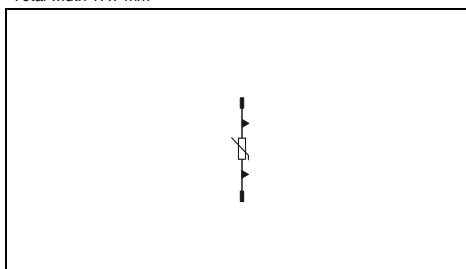

Total width 17.7 mm

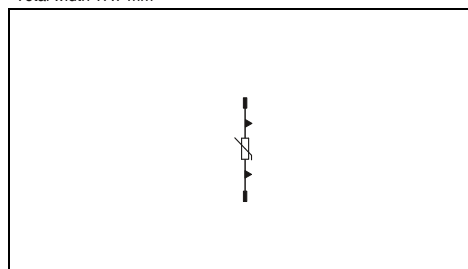

<b>Electrical data</b>
IEC category / EN type
Nominal voltage $U_N$
Maximum continuous operating voltage $U_C$
Nominal discharge surge current $I_n$ (8/20) $\mu$ s
Residual voltage at 5 kA
Protection level $U_p$
Backup fuse max. in acc. with IEC
<b>General data</b>
Dimensions W / H / D
Temperature range
Degree of protection in acc. with IEC 60529/ EN 60529
Housing material
Inflammability class in acc. with UL 94
Test standards

Technical data		
... 60 ST	... 120 ST	... 240 ST
II / T2	II / T2	II / T2
60 V AC	120 V AC	240 V AC
75 V AC	150 V AC	275 V AC
10 kA	20 kA	20 kA
$\leq 325$ V	$\leq 550$ V	$\leq 1$ kV
$\leq 500$ V	$\leq 800$ V	$\leq 1.35$ kV
125 A (gL (AC))		
Dimensions W / H / D		
17.7 mm / 52.4 mm / 54.5 mm		
Temperature range		
-40 °C ... 80 °C		
Degree of protection		
IP20		
Housing material		
PA 6.6		
Inflammability class		
V0		
Test standards		
IEC 61643-1 / DIN EN 61643-11 / DIN EN 61643-11/A11 / UL 1449 / IEEE C62.1 / C62.34 / C62.45		

Technical data		
... 277 ST	... 347 ST	... 480 ST
II / T2	II / T2	II / T2
277 V AC	347 V AC	480 V AC
385 V AC	440 V AC	580 V AC
20 kA	20 kA	15 kA
$\leq 1.35$ kV	$\leq 1.5$ kV	$\leq 2.1$ kV
$\leq 1.8$ kV	$\leq 2.2$ kV	$\leq 2.5$ kV
125 A (gL)		
Dimensions W / H / D		
17.7 mm / 52.4 mm / 54.5 mm		
Temperature range		
-40 °C ... 80 °C		
Degree of protection		
IP20		
Housing material		
PA 6.6		
Inflammability class		
V0		
Test standards		
IEC 61643-1 / EN 61643-11/A11 / NF C61-740		

Description	Nominal voltage $U_N$
<b>VALVETRAB</b> surge protection plug	60 V AC
	120 V AC
	240 V AC
	277 V AC
	347 V AC
	480 V AC

Ordering data			
Type	Order No.	Pcs. / Pkt.	
VAL-US 60 ST	2800738	10	
VAL-US 120 ST	2800739	10	
VAL-US 240 ST	2800740	10	

Ordering data			
Type	Order No.	Pcs. / Pkt.	
VAL-US 277 ST	2800741	10	
VAL-US 347 ST	2800742	10	
VAL-US 480 ST	2800743	10	

VALVETRAB, base element for 4-wire systems, L1, L2, L3, PEN, for individual assembly with VAL-MS...ST	
with remote indication contact	3L-PEN
without remote indication contact	3L-PEN
VALVETRAB, base element for 3-wire systems, L1, L2, PEN, for individual assembly with VAL-MS...ST	
with remote indication contact	2L-GND
without remote indication contact	2L - PEN
VALVETRAB, single-position base element	
with remote indication contact	
without remote indication contact	

Accessories			
Type	Order No.	Pcs. / Pkt.	
VAL-MS/3+0-BE/FM	2881803	1	
VAL-MS/3+0-BE	2881816	1	
VAL-MS/2+0-BE/FM	2805321	1	
VAL-MS/2+0-BE	2804584	1	
VAL-MS BE/FM	2817738	10	
VAL-MS BE	2817741	10	

Accessories			
Type	Order No.	Pcs. / Pkt.	
VAL-MS/3+0-BE/FM	2881803	1	
VAL-MS/3+0-BE	2881816	1	
VAL-MS/2+0-BE/FM	2805321	1	
VAL-MS/2+0-BE	2804584	1	
VAL-MS BE/FM	2817738	10	
VAL-MS BE	2817741	10	

# Surge protection and interference filters

## Surge protection for the power supply unit

### Type 2 surge arresters

#### VALVETRAB MS 65/80 kA performance class

- Multi-channel type 2 arrester
- Type 2 seamless plug-in surge arrester
- Secure hold of connectors in the event of high lightning current loads and strong vibration thanks to new latching
- Disconnect device on each individual connector
- Optical, mechanical status indication for the individual arresters
- With or without floating remote indication contact
- Mechanical keying of all slots
- Connectors can be checked with CHECKMASTER

**Notes:**  
For certifications, see page 154



5-conductor system; L1, L2, L3, N, PE

Total width 71.2 mm

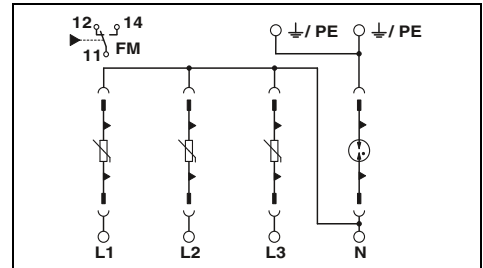

Electrical data	
IEC category / EN type	L-N / N-PE / L-PEN
Nominal voltage $U_N$	L-N / N-PE / L-PEN
Maximum continuous operating voltage $U_C$	L-N / N-PE / L-PEN
Nominal discharge surge current $I_n$ (8/20) $\mu$ s	L-N / N-PE / L-PEN
Max. discharge surge current $I_{max}$ (8/20) $\mu$ s	L-N / N-PE / L-PEN
Residual voltage at 5 kA	L-N / N-PE / L-PEN
Protection level $U_p$	L-N / N-PE / L-PEN
Response time $t_A$	L-N / N-PE / L-PEN
Backup fuse max. in acc. with IEC	L-N / N-PE / L-PEN
Immunity to short-circuiting (with max. backup fuse) $I_p$	L-N / N-PE / L-PEN
General data	
Dimensions W / H / D	L-N / N-PE / L-PEN
Connection data solid / stranded / AWG	L-N / N-PE / L-PEN
Temperature range	L-N / N-PE / L-PEN
Inflammability class in acc. with UL 94	L-N / N-PE / L-PEN
Test standards	L-N / N-PE / L-PEN
Remote indication contact	
Connection data solid / stranded / AWG	L-N / N-PE / L-PEN
Max. operating voltage	L-N / N-PE / L-PEN
Max. operating current	L-N / N-PE / L-PEN
Min. operational current	L-N / N-PE / L-PEN

Technical data	
.. 385/65	.. 385/80
II / T2	II / T2
240 V AC (230/400 V AC ... 240/415 V AC)	240 V AC (230/400 V AC ... 240/415 V AC)
385 V AC / 264 V AC / -	385 V AC / 264 V AC / -
30 kA / 40 kA / -	40 kA / 40 kA / -
65 kA / 80 kA / -	80 kA / 80 kA / -
$\leq 1.25$ kV / $\leq 0.5$ kV / -	$\leq 1.25$ kV / $\leq 0.5$ kV / -
$\leq 1.8$ kV / $\leq 1.7$ kV / -	$\leq 2$ kV / $\leq 1.7$ kV / -
$\leq 25$ ns / $\leq 100$ ns / -	$\leq 25$ ns / $\leq 100$ ns / -
	250 A (gL/gG)
	25 kA
	71.2 mm / 99 mm / 77.5 mm
	1.5 ... 35 mm <sup>2</sup> / 1.5 ... 25 mm <sup>2</sup> / 15 - 2
	-40 °C ... 80 °C
	V0
	IEC 61643-1 / EN 61643-11/A11
	PDT, 1-pos.
	0.14 ... 1.5 mm <sup>2</sup> / 0.14 ... 1.5 mm <sup>2</sup> / 28 - 16
	250 V AC
	1.5 A AC (250 V AC) / 1.5 A DC (30 V DC)
	5 mA (5 V)

Description	$I_{max}$	$U_C$
<b>VALVETRAB MS</b>		
with remote indication contact	65 kA	385 V AC
without remote indication contact	65 kA	385 V AC
<b>VALVETRAB MS</b>		
with remote indication contact	80 kA	385 V AC
without remote indication contact	80 kA	385 V AC

Replacement connector	
For VAL-MS 385/65...	1L-N/PE
For VAL-MS 385/80...	1L-N/PE
	N-PE

**Marking material**

Ordering data		
Type	Order No.	Pcs. / Pkt.
<b>VAL-MS 385/65/3+1-FM</b>	2920887	1
<b>VAL-MS 385/65/3+1</b>	2920890	1
<b>VAL-MS 385/80/3+1-FM</b>	2920968	1
<b>VAL-MS 385/80/3+1</b>	2920971	1

Accessories		
Type	Order No.	Pcs. / Pkt.
<b>VAL-MS 385/65 ST</b>	2920308	10
<b>VAL-MS 385/80 ST</b>	2920353	10
<b>F-MS 80 ST</b>	2921307	10

ZBN 18 ..., see page 63



4-conductor system; L1, L2, L3, PEN



3-conductor system; L, N, PE

Total width 53.4 mm

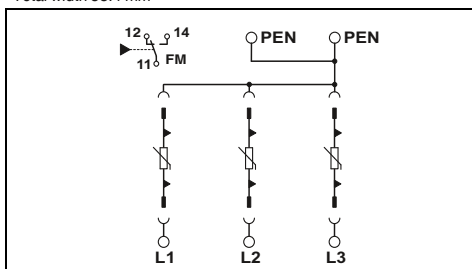

Total width 35.6 mm

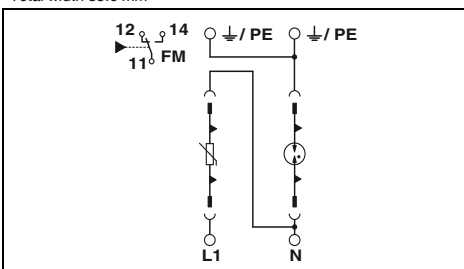

### Technical data

.. 385/65	.. 385/80
II / T2	II / T2
240 V AC (230/400 V AC ... 240/415 V AC)	240 V AC (230/400 V AC ... 240/415 V AC)
- / - / 385 V AC	- / - / 385 V AC
- / - / 90 kA (all channels)	- / - / 120 kA (all channels)
- / - / 150 kA (all channels)	- / - / 200 kA (all channels)
- / - / ≤ 1.2 kV	- / - / ≤ 1.2 kV
- / - / ≤ 1.8 kV	- / - / ≤ 2 kV
- / - / ≤ 25 ns	- / - / ≤ 25 ns
	250 A (gL/gG) 25 kA

### Technical data

.. 385/65	.. 385/80
II / T2	II / T2
240 V AC (230 V AC ... 240 V AC)	240 V AC (230 V AC ... 240 V AC)
385 V AC / 264 V AC / -	385 V AC / 264 V AC / -
30 kA / 40 kA / -	40 kA / 40 kA / -
65 kA / 80 kA / -	80 kA / 80 kA / -
≤ 1.2 kV / ≤ 0.5 kV / -	≤ 1.2 kV / ≤ 0.5 kV / -
≤ 1.8 kV / ≤ 1.7 kV / -	≤ 2 kV / ≤ 1.7 kV / -
≤ 25 ns / ≤ 100 ns / -	≤ 25 ns / ≤ 100 ns / -
	250 A (gL/gG) 25 kA

53.4 mm / 99 mm / 77.5 mm  
1.5 ... 35 mm<sup>2</sup> / 1.5 ... 25 mm<sup>2</sup> / 15 - 2  
-40 °C ... 80 °C  
V0

IEC 61643-1 / EN 61643-11/A11

PDT, 1-pos.

0.14 ... 1.5 mm<sup>2</sup> / 0.14 ... 1.5 mm<sup>2</sup> / 28 - 16  
250 V AC  
1.5 A AC (250 V AC) / 1.5 A DC (30 V DC)  
5 mA (5 V)

35.6 mm / 99 mm / 77.5 mm  
1.5 ... 35 mm<sup>2</sup> / 1.5 ... 25 mm<sup>2</sup> / 15 - 2  
-40 °C ... 80 °C  
V0

IEC 61643-1 / EN 61643-11/A11

PDT, 1-pos.

0.14 ... 1.5 mm<sup>2</sup> / 0.14 ... 1.5 mm<sup>2</sup> / 28 - 16  
250 V AC  
1.5 A AC (250 V AC) / 1.5 A DC (30 V DC)  
5 mA (5 V)

### Ordering data

Type	Order No.	Pcs. / Pkt.
VAL-MS 385/65/3+0-FM	2921006	1
VAL-MS 385/65/3+0	2921019	1
VAL-MS 385/80/3+0-FM	2921080	1
VAL-MS 385/80/3+0	2921093	1

### Ordering data

Type	Order No.	Pcs. / Pkt.
VAL-MS 385/65/1+1-FM	2921242	1
VAL-MS 385/65/1+1	2921255	1
VAL-MS 385/80/1+1-FM	2921284	1
VAL-MS 385/80/1+1	2921297	1

### Accessories

Type	Order No.	Pcs. / Pkt.
VAL-MS 385/65 ST	2920308	10
VAL-MS 385/80 ST	2920353	10

### Accessories

Type	Order No.	Pcs. / Pkt.
VAL-MS 385/65 ST	2920308	10
VAL-MS 385/80 ST	2920353	10
F-MS 80 ST	2921307	10

ZBN 18 ..., see page 63

ZBN 18 ..., see page 63

# Surge protection and interference filters

## Surge protection for the power supply unit

### Surge protection for special applications

- Universal pluggability
- Also suitable for industry solutions, e.g., in the rail and telecommunications sectors
- Thermal disconnect device for each individual connector
- Optical, mechanical status indication for the individual arresters
- With or without floating remote indication contact
- Mechanical keying of all slots
- Connectors can be checked with CHECKMASTER



For nominal voltages up to 48 V DC



For nominal voltages up to 48 V AC

**Notes:**  
For certifications, see page 154

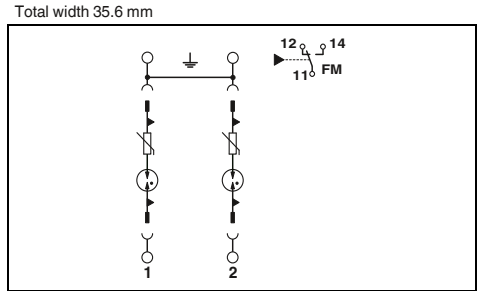
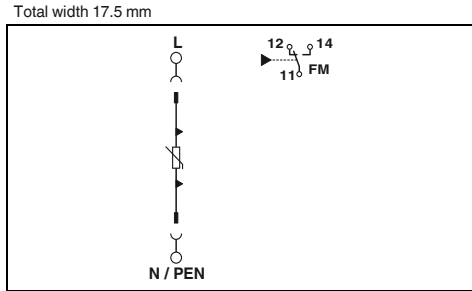

Electrical data	
IEC category / EN type	I, II / T1, T2
Nominal voltage $U_N$	60 V AC/DC
Maximum continuous operating voltage $U_C$	75 V AC / 100 V DC
Nominal discharge surge current $I_n$ (8/20) $\mu$ s	12.5 kA
Max. discharge surge current $I_{max}$ (8/20) $\mu$ s	30 kA
Residual voltage at 5 kA	$\leq 0.3$ kV
Protection level $U_p$	$\leq 0.4$ kV
Response time $t_A$	$\leq 25$ ns
Backup fuse max. in acc. with IEC	160 A (gL/gG)
General data	
Dimensions W / H / D	17.5 mm / 97 mm / 77.5 mm
Connection data solid / stranded / AWG	1.5 ... 35 mm <sup>2</sup> / 1.5 ... 25 mm <sup>2</sup> / 15 - 2
Temperature range	-40 °C ... 80 °C
Inflammability class in acc. with UL 94	V0
Test standards	IEC 61643-11 / EN 61643-11/A11
Remote indication contact	PDT, 1-pos.
Connection data solid / stranded / AWG	0.14 ... 1.5 mm <sup>2</sup> / 0.14 ... 1.5 mm <sup>2</sup> / 28 - 16
Max. operating voltage	250 V AC
Max. operating current	1.5 A AC (250 V AC) / 1.5 A DC (30 V DC)

Technical data			
		Base element	Plug
		-	II / T2
		240 V AC (415 V AC)	48 V AC (5 V...48 V AC)
		-	75 V AC / 100 V DC
		-	10 kA
		-	20 kA
		-	$\leq 350$ V
		-	$\leq 1.4$ kV
		-	$\leq 100$ ns
		63 A (gL / gG)	63 A (gL / gG)
Ordering data			
Description	$U_C$	Type	Order No.
VALVETRAB-MS, varistor-based lightning arrester			
with remote indication contact	75 V AC	VAL-MS-T1/T2 48/12.5/1+0-FM	2801240
without remote indication contact	75 V AC	VAL-MS-T1/T2 48/12.5/1+0	2801241
Protective plug, for inserting in base element			
	75 V AC		
Base element, for individual assembly with protective plugs			
with remote indication contact			
Replacement connector	L-N / L-PEN		
Labeling material			

Technical data			
		Base element	Plug
		-	II / T2
		240 V AC (415 V AC)	48 V AC (5 V...48 V AC)
		-	75 V AC / 100 V DC
		-	10 kA
		-	20 kA
		-	$\leq 350$ V
		-	$\leq 1.4$ kV
		-	$\leq 100$ ns
		63 A (gL / gG)	63 A (gL / gG)
Ordering data			
Description	$U_C$	Type	Order No.
VAL-MS 75 VF ST			2805318
VAL-MS/2+0-BE/FM/S2			2800246
Replacement connector	L-N / L-PEN		
Labeling material			

Ordering data			
Description	$U_C$	Type	Order No.
VALVETRAB-MS, varistor-based lightning arrester			
with remote indication contact	75 V AC	VAL-MS-T1/T2 48/12.5/1+0-FM	2801240
without remote indication contact	75 V AC	VAL-MS-T1/T2 48/12.5/1+0	2801241
Protective plug, for inserting in base element			
	75 V AC		
Base element, for individual assembly with protective plugs			
with remote indication contact			
Replacement connector	L-N / L-PEN		
Labeling material			

Accessories			
Replacement connector	L-N / L-PEN	VAL-MS-T1/T2 48/12.5 ST	2801242
Labeling material			ZBN 18 ..., see page 63

Ordering data			
Description	$U_C$	Type	Order No.
VAL-MS 75 VF ST			2805318
VAL-MS/2+0-BE/FM/S2			2800246
Replacement connector	L-N / L-PEN		
Labeling material			ZBN 18 ..., see page 63

Accessories			
Replacement connector	L-N / L-PEN		
Labeling material			ZBN 18 ..., see page 63

### Surge protection for use in wind power plants

- For power supplies with higher supply voltages
- Other solutions for power supplies  $U_N \geq 400$  V available on request
- Universal pluggability
- Thermal disconnect device for each individual connector
- Optical, mechanical status indication for the individual arresters
- With or without floating remote indication contact
- Mechanical keying of all slots
- Connectors can be checked with CHECKMASTER



Free of leakage current, for nominal voltages up to 690 V AC, e.g., rotor protection for wind power plants



4-conductor system; L1, L2, L3, PEN (554/960 V TN-C system)

**Notes:**  
For certifications, see page 154

Total width 35.6 mm

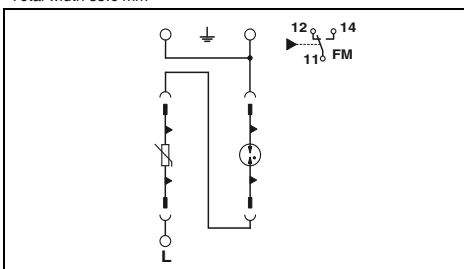

#### Technical data

Electrical data	
IEC category / EN type	II / T2
Nominal voltage $U_N$	690 V AC
Maximum continuous operating voltage $U_C$	800 V AC
Nominal discharge surge current $I_n$ (8/20) $\mu$ s	15 kA
Protection level $U_p$	L-PEN - $\leq 5$ kV
Response time $t_A$	L-PEN - $\leq 100$ ns
General data	
Dimensions W / H / D	35.6 mm / 97 mm / 65.5 mm
Connection data solid / stranded / AWG	1.5 ... 35 mm <sup>2</sup> / 1.5 ... 25 mm <sup>2</sup> / 15 - 2
Temperature range	-40 °C ... 80 °C
Degree of protection in acc. with IEC 60529/ EN 60529	IP20
Test standards	IEC 61643-1 / DIN EN 61643-11 / DIN EN 61643-11/A11
Remote indication contact	PDT, 1-pos.
Connection data solid / stranded / AWG	0.14 ... 1.5 mm <sup>2</sup> / 0.14 ... 1.5 mm <sup>2</sup> / 28 - 16
Max. operating voltage	250 V AC / 30 V DC
Max. operating current	1.5 A AC (250 V AC) / 1 A DC (30 V DC)

#### Ordering data

Description	Type	Order No.	Pcs. / Pkt.
VALVETRAB MS, for mounting on NS 35 with remote indication contact	VAL-MS 800/30 VF/FM	2805402	1
without remote indication contact			

#### Accessories

Replacement connector	1L-N/PE	VAL-MS 750/30-ST	2920256	10
		F-MS 2200/30 ST	2805392	10

Labeling material

ZBN 18 ..., see page 63

Total width 53.4 mm

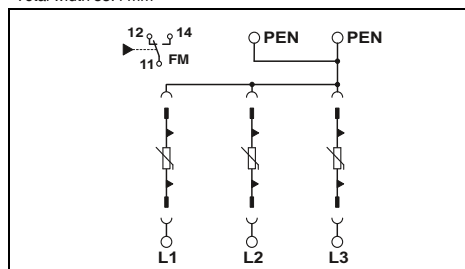

#### Technical data

Electrical data	
IEC category / EN type	II / T2
Nominal voltage $U_N$	554 V AC (554/960 V AC TN-C)
Maximum continuous operating voltage $U_C$	750 V AC
Nominal discharge surge current $I_n$ (8/20) $\mu$ s	-
Protection level $U_p$	45 kA (all channels)
Response time $t_A$	- $\leq 2.7$ kV
	- $\leq 25$ ns
General data	
Dimensions W / H / D	53.4 mm / 99 mm / 65.5 mm
Connection data solid / stranded / AWG	1.5 ... 35 mm <sup>2</sup> / 1.5 ... 25 mm <sup>2</sup> / 15 - 2
Temperature range	-40 °C ... 80 °C
Degree of protection in acc. with IEC 60529/ EN 60529	IP20
Test standards	IEC 61643-1 / DIN EN 61643-11 / DIN EN 61643-11/A11
Remote indication contact	PDT
Connection data solid / stranded / AWG	0.14 ... 1.5 mm <sup>2</sup> / 0.14 ... 1.5 mm <sup>2</sup> / 28 - 16
Max. operating voltage	250 V AC / 30 V DC
Max. operating current	1.5 A AC (250 V AC) / 1 A DC (30 V DC)

#### Ordering data

Description	Type	Order No.	Pcs. / Pkt.
VAL-MS 750/30/3+0-FM	VAL-MS 750/30/3+0-FM	2920272	1
VAL-MS 750/30/3+0	VAL-MS 750/30/3+0	2920269	1

#### Accessories

Replacement connector	VAL-MS 750/30-ST	2920256	10
-----------------------	------------------	---------	----

ZBN 18 ..., see page 63

# Surge protection and interference filters

## Surge protection for the power supply unit

### Type 2 surge arresters with RCD Combi-RCD

- For 5-conductor systems; L1, L2, L3, N, PE
- Combination of type 2 surge arrester and RCD residual current circuit breaker
- Personal protection and device protection in a single device
- Type 2 seamless plug-in surge arrester
- Disconnect device on each individual connector
- Optical, mechanical status indication for all protective connectors
- Residual current circuit breaker is not triggered by magnetic influences caused by discharge currents in the type 2 arrester
- Connectors can be checked with CHECKMASTER

**Notes:**  
For certifications, see page 154



With selective RCD residual current circuit breaker, 300 mA



With selective RCD residual current circuit breaker, 30 mA

Total width 121 mm

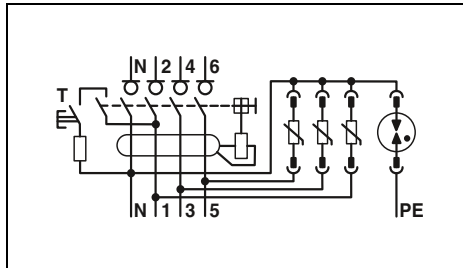

Total width 121 mm

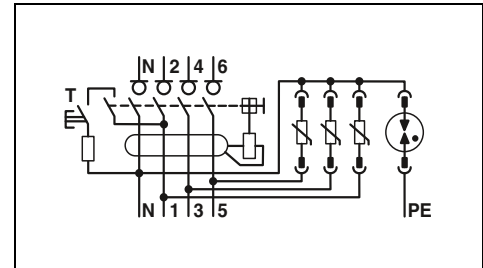

#### Technical data

Electrical data	
IEC category / EN type	II / T2
Nominal voltage $U_N$	240 V AC (230/400 V AC ... 240/415 V AC)
Maximum continuous operating voltage $U_C$	L-N / N-PE 350 V AC / 264 V AC
Nominal discharge surge current $I_n$ (8/20) $\mu$ s	L-N / N-PE 60 kA (all channels) / 20 kA
Max. discharge surge current $I_{max}$ (8/20) $\mu$ s	L-N / N-PE 90 kA (all channels) / 30 kA
Residual voltage at 5 kA	L-N / N-PE $\leq 1.2$ kV / $\leq 0.3$ kV
Protection level $U_p$	L-N / N-PE $\leq 2$ kV / $\leq 2$ kV
Response time $t_{\Delta}$	L-N / N-PE $\leq 25$ ns / $\leq 100$ ns

General data	
Dimensions W / H / D	121 mm / 90 mm / 76 mm
Connection data solid / stranded / AWG	4 ... 16 mm <sup>2</sup> / 4 ... 16 mm <sup>2</sup> / 12 - 4
Temperature range	-25 °C ... 40 °C
Inflammability class in acc. with UL 94	V0
Test standards	IEC 61643-1 / EN 61643-11 / IEC 61008-1 / IEC 61008-1/A11 / IEC 61008-2-1 / IEC 60947-3

RCD data	
Class	A selective
Nominal load current $I_L$	40 A
Dimensioning error current	300 mA
Rated making and breaking capacity $I_m$	630 A
Rated residual making and breaking capacity $I_{\Delta m}$	630 A
Surge withstand capability	6 kV (1.2/50 $\mu$ s)
Immunity to short-circuiting $I_{sc}$	10 kA Back-up fuse: 63 A
Tripping time for $I_{\Delta n}$	$\leq 300$ ms
Tripping time for $5xI_{\Delta n}$	$\leq 40$ ms
Cycles, max.	20000
Utilization category	AC 23 A

#### Technical data

Electrical data	
IEC category / EN type	II / T2
Nominal voltage $U_N$	240 V AC (230/400 V AC ... 240/415 V AC)
Maximum continuous operating voltage $U_C$	L-N / N-PE 350 V AC / 264 V AC
Nominal discharge surge current $I_n$ (8/20) $\mu$ s	L-N / N-PE 60 kA (all channels) / 20 kA
Max. discharge surge current $I_{max}$ (8/20) $\mu$ s	L-N / N-PE 90 kA (all channels) / 30 kA
Residual voltage at 5 kA	L-N / N-PE $\leq 1.2$ kV / $\leq 0.3$ kV
Protection level $U_p$	L-N / N-PE $\leq 2$ kV / $\leq 2$ kV
Response time $t_{\Delta}$	L-N / N-PE $\leq 25$ ns / $\leq 100$ ns

General data	
Dimensions W / H / D	121 mm / 90 mm / 76 mm
Connection data solid / stranded / AWG	4 ... 16 mm <sup>2</sup> / 4 ... 16 mm <sup>2</sup> / 12 - 4
Temperature range	-25 °C ... 40 °C
Inflammability class in acc. with UL 94	V0
Test standards	IEC 61643-1 / EN 61643-11 / IEC 61008-1 / IEC 61008-1/A11 / IEC 61008-2-1 / IEC 60947-3

RCD data	
Class	A
Nominal load current $I_L$	40 A
Dimensioning error current	30 mA
Rated making and breaking capacity $I_m$	1.5 kA
Rated residual making and breaking capacity $I_{\Delta m}$	2.5 kA
Surge withstand capability	6 kV (1.2/50 $\mu$ s)
Immunity to short-circuiting $I_{sc}$	10 kA Back-up fuse: 63 A
Tripping time for $I_{\Delta n}$	$\leq 300$ ms
Tripping time for $5xI_{\Delta n}$	$\leq 40$ ms
Cycles, max.	20000
Utilization category	AC 23 A

#### Ordering data

Description	Type	Order No.	Pcs. / Pkt.
VALVETRAB compact with RCD	VAL-CP-RCD-3S/40/0.3/SEL	2808001	1

#### Ordering data

Description	Type	Order No.	Pcs. / Pkt.
VALVETRAB compact with RCD	VAL-CP-RCD-3S/40/0.03	2882802	1

#### Accessories

Replacement connector	Type	Order No.	Pcs. / Pkt.
L-N / L-PEN	VAL-CP-350-ST-GY	2882718	10
N-PE	VAL-CP-N/PE-350-ST-GY	2882734	10

#### Accessories

Replacement connector	Type	Order No.	Pcs. / Pkt.
L-N / L-PEN	VAL-CP-350-ST-GY	2882718	10
N-PE	VAL-CP-N/PE-350-ST-GY	2882734	10

### Type 2 surge arresters for 60 mm system technology

#### Combi-MCB

- Combinations of type 2 arresters with integrated arrester backup fuse
- For 60 mm system technology
- Tool-free mounting on 5 and 10 mm bus-bars
- Signaling to monitoring systems via remote indication contact in the event of an error
- Surge-proof arrester backup fuse tailored to type 2 arresters
- Type 2 seamless plug-in surge arrester
- Disconnect device on each individual connector
- Optical, mechanical status indication for the individual arresters
- Connectors can be checked with CHECKMASTER

#### Notes:

For certifications, see page 154

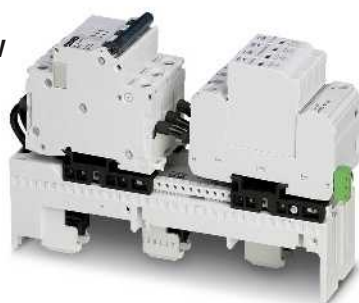

5-conductor system; L1, L2, L3, N, PE

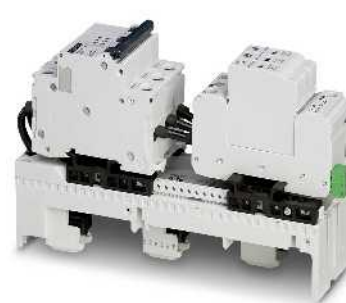

4-conductor system; L1, L2, L3, PEN

Total width 54 mm

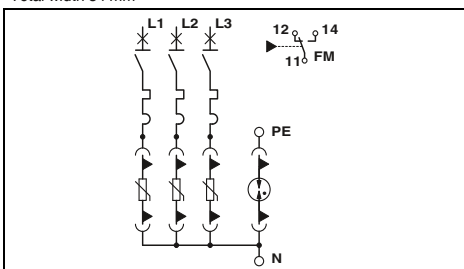

Total width 54 mm

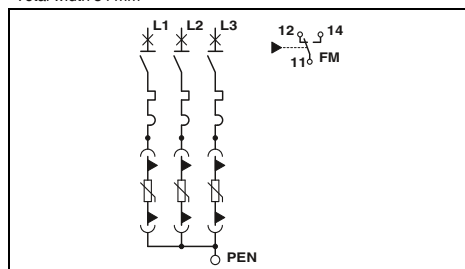

#### Technical data

Electrical data	
IEC category / EN type	II / T2
Nominal voltage $U_N$	240 V AC (230/400 V AC ... 240/415 V AC)
Maximum continuous operating voltage $U_C$	L-N / N-PE / L-PEN 350 V AC / 264 V AC / -
Nominal discharge surge current $I_n$ (8/20) $\mu$ s	L-N / N-PE / L-PEN 60 kA (all channels) / 20 kA / -
Max. discharge surge current $I_{max}$ (8/20) $\mu$ s	L-N / N-PE / L-PEN 75 kA (all channels) / 40 kA / -
Residual voltage at 5 kA	L-N / N-PE / L-PEN $\leq 1.8$ kV / $\leq 0.25$ kV / -
Protection level $U_p$	L-N / N-PE / L-PEN $\leq 2.5$ kV / $\leq 1.5$ kV / -
Response time $t_A$	L-N / N-PE / L-PEN $\leq 25$ ns / $\leq 100$ ns / -
Backup fuse max. in acc. with IEC	(Not required)
Immunity to short-circuiting (with max. backup fuse) $I_p$	25 kA
Rated surge current resistance $I_{pk}$	52 kA
General data	
Dimensions W / H / D	54 mm / 220 mm / 110 mm
Connection data solid / stranded / AWG	2.5 ... 25 mm <sup>2</sup> / 2.5 ... 16 mm <sup>2</sup> / 12 - 4
Temperature range	-25 °C ... 60 °C
Inflammability class in acc. with UL 94	V0
Test standards	IEC 61643-1 / EN 61643-11 / EN 61643-11/A11
Remote indication contact	PDT
Connection data solid / stranded / AWG	0.14 ... 1.5 mm <sup>2</sup> / 0.14 ... 1.5 mm <sup>2</sup> / 28 - 16
Max. operating voltage	250 V AC / 125 V DC
Max. operating current	1 A AC (ohmic) / 0.2 A DC (ohmic)

#### Technical data

Electrical data	
IEC category / EN type	II / T2
Nominal voltage $U_N$	240 V AC (230/400 V AC ... 240/415 V AC)
Maximum continuous operating voltage $U_C$	- / - / 350 V AC
Nominal discharge surge current $I_n$ (8/20) $\mu$ s	- / - / 60 kA (all channels)
Max. discharge surge current $I_{max}$ (8/20) $\mu$ s	- / - / 75 kA (all channels)
Residual voltage at 5 kA	- / - / $\leq 1.8$ kV
Protection level $U_p$	- / - / $\leq 2.5$ kV
Response time $t_A$	- / - / $\leq 25$ ns
Backup fuse max. in acc. with IEC	(Not required)
Immunity to short-circuiting (with max. backup fuse) $I_p$	25 kA
Rated surge current resistance $I_{pk}$	52 kA
General data	
Dimensions W / H / D	54 mm / 220 mm / 110 mm
Connection data solid / stranded / AWG	2.5 ... 25 mm <sup>2</sup> / 2.5 ... 16 mm <sup>2</sup> / 12 - 4
Temperature range	-25 °C ... 60 °C
Inflammability class in acc. with UL 94	V0
Test standards	IEC 61643-1 / EN 61643-11 / EN 61643-11/A11
Remote indication contact	PDT
Connection data solid / stranded / AWG	0.14 ... 1.5 mm <sup>2</sup> / 0.14 ... 1.5 mm <sup>2</sup> / 28 - 16
Max. operating voltage	250 V AC / 125 V DC
Max. operating current	1 A AC (ohmic) / 0.2 A DC (ohmic)

#### Ordering data

Description	
<b>VALVETRAB compact</b>	

Type	Order No.	Pcs. / Pkt.
VAL-CP-MOSO 60-3S-FM	2804403	1

#### Ordering data

Type	Order No.	Pcs. / Pkt.
VAL-CP-MOSO 60-3C-FM	2804416	1

#### Accessories

Replacement connector	L-N / L-PEN N-PE
-----------------------	---------------------

Accessories	Order No.	Pcs. / Pkt.
VAL-CP-350-ST-GY	2882718	10
VAL-CP-N/PE-350-ST-GY	2882734	10

#### Accessories

Accessories	Order No.	Pcs. / Pkt.
VAL-CP-350-ST-GY	2882718	10

#### Marking material

ZBF 12 ..., see page 63

ZBF 12 ..., see page 63

# Surge protection and interference filters

## Surge protection for the power supply unit

### Type 2 surge arresters with integrated backup fuse Combi-MCB

- Combinations of type 2 arresters with integrated arrester backup fuse
- Overload of the surge protection results in all-pole disconnection from the mains
- Signaling to monitoring systems via remote indication contact in the event of an error
- Surge-proof arrester backup fuse tailored to type 2 arresters
- Type 2 seamless plug-in surge arrester
- Disconnect device on each individual connector
- Optical, mechanical status indication for the individual arresters
- Connectors can be checked with CHECKMASTER

**Notes:**  
For certifications, see page 154



5-conductor system; L1, L2, L3, N, PE

Total width 131.5 mm

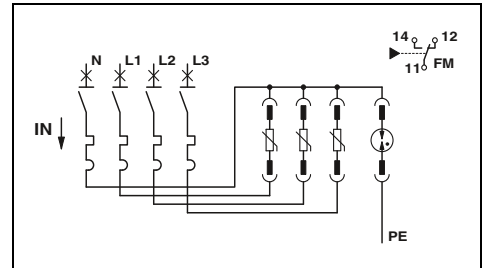

#### Technical data

Electrical data		Technical data	
IEC category / EN type		II / T2	
Nominal voltage $U_N$		240 V AC (230/400 V AC ... 240/415 V AC)	
Maximum continuous operating voltage $U_C$	L-N / N-PE / L-PEN	350 V AC / 264 V AC / -	
Nominal discharge surge current $I_n$ (8/20) $\mu$ s	L-N / N-PE / L-PEN	60 kA (all channels) / 20 kA / -	
Max. discharge surge current $I_{max}$ (8/20) $\mu$ s	L-N / N-PE / L-PEN	90 kA (all channels) / 30 kA / -	
Residual voltage at 5 kA	L-N / N-PE / L-PEN	$\leq 1.3$ kV / $\leq 0.5$ kV / -	
Protection level $U_p$	L-N / N-PE / L-PEN	$\leq 2.5$ kV / $\leq 1.7$ kV / -	
Response time $t_A$	L-N / N-PE / L-PEN	$\leq 25$ ns / $\leq 100$ ns / -	
Backup fuse max. in acc. with IEC		(Not required)	
Immunity to short-circuiting (with max. backup fuse) $I_p$		25 kA	
General data		Ordering data	
Dimensions W / H / D		131.5 mm / 101 mm / 76 mm	
Connection data solid / stranded / AWG		2.5 ... 25 mm <sup>2</sup> / 2.5 ... 16 mm <sup>2</sup> / 12 - 4	
Temperature range		-25 °C ... 60 °C	
Inflammability class in acc. with UL 94		V0	
Test standards		IEC 61643-1 / EN 61643-11 / IEC 60364-4-443 / IEC 60364-5-534	
Remote indication contact		PDT, 1-pos.	
Connection data solid / stranded / AWG		0.14 ... 1.5 mm <sup>2</sup> / 0.14 ... 1.5 mm <sup>2</sup> / 28 - 16	
Max. operating voltage		250 V AC / 250 V DC	
Max. operating current		2 A AC / 50 mA DC	

Description
VALVETRAB compact, with an arrester backup fuse

Type	Order No.	Pcs. / Pkt.
VAL-CP-MCB-3S-350/40/FM	2882750	1

Replacement connector	
	L-N / L-PEN
	N-PE

Accessories		
	Order No.	Pcs. / Pkt.
VAL-CP-350-ST-GY	2882718	10
VAL-CP-N/PE-350-ST-GY	2882734	10





4-conductor system; L1, L2, L3, PEN

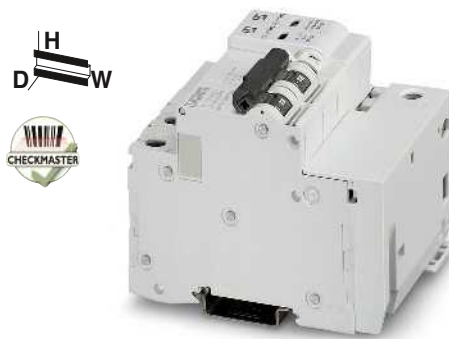

3-conductor system; L, N, PE

Total width 114 mm

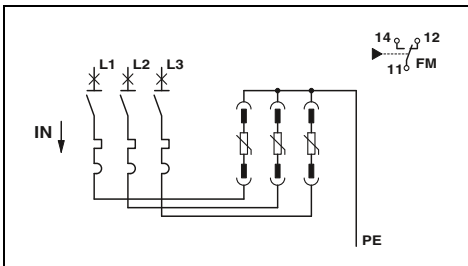

### Technical data

II / T2  
240 V AC (230/400 V AC ... 240/415 V AC)  
- / - / 350 V AC  
- / - / 60 kA (all channels)  
- / - / 90 kA (all channels)  
- / - / ≤ 1.3 kV  
- / - / ≤ 2.5 kV  
- / - / ≤ 25 ns  
(Not required)  
25 kA

114 mm / 101 mm / 76 mm  
2.5 ... 25 mm<sup>2</sup> / 2.5 ... 16 mm<sup>2</sup> / 12 - 4  
-25 °C ... 60 °C  
V0  
IEC 61643-1 / EN 61643-11 / IEC 60364-4-443 /  
IEC 60364-5-534  
PDT, 1-pos.  
0.14 ... 1.5 mm<sup>2</sup> / 0.14 ... 1.5 mm<sup>2</sup> / 28 - 16  
250 V AC / 250 V DC  
2 A AC / 50 mA DC

### Ordering data

Type	Order No.	Pcs. / Pkt.
VAL-CP-MCB-3C-350/40/FM	2882776	1

### Accessories

VAL-CP-350-ST-GY	2882718	10
------------------	---------	----

Total width 72 mm

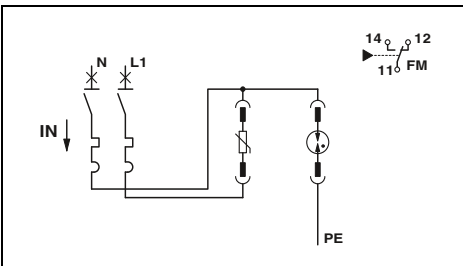

### Technical data

II / T2  
240 V AC (230/400 V AC ... 240/415 V AC)  
350 V AC / 264 V AC / -  
20 kA / 20 kA / -  
30 kA / 30 kA / -  
≤ 1.3 kV / ≤ 0.5 kV / -  
≤ 2.5 kV / ≤ 1.7 kV / -  
≤ 25 ns / ≤ 100 ns / -  
(Not required)  
25 kA

72 mm / 101 mm / 76 mm  
2.5 ... 25 mm<sup>2</sup> / 2.5 ... 16 mm<sup>2</sup> / 12 - 4  
-25 °C ... 60 °C  
V0  
IEC 61643-1 / EN 61643-11 / IEC 60364-4-443 /  
IEC 60364-5-534  
PDT, 1-pos.  
0.14 ... 1.5 mm<sup>2</sup> / 0.14 ... 1.5 mm<sup>2</sup> / 28 - 16  
250 V AC / 250 V DC  
2 A AC / 50 mA DC

### Ordering data

Type	Order No.	Pcs. / Pkt.
VAL-CP-MCB-1S-350/40/FM	2882763	1

### Accessories

VAL-CP-350-ST-GY	2882718	10
VAL-CP-N/PE-350-ST-GY	2882734	10

# Surge protection and interference filters

## Surge protection for the power supply unit

### Type 3 device protection MAINS-PLUGTRAB

- For single and multi-phase power supply units
- Rail-mountable module
- Comprising base element and connector
- With floating remote indication contact
- Optical signaling of disconnection via LED
- Tool-free connector replacement
- Connectors can be checked with CHECKMASTER

**Notes:**  
For certifications, see page 154



5-conductor system; L1, L2, L3, N, PE



3-conductor system; L, N, PE

Total width 35.4 mm

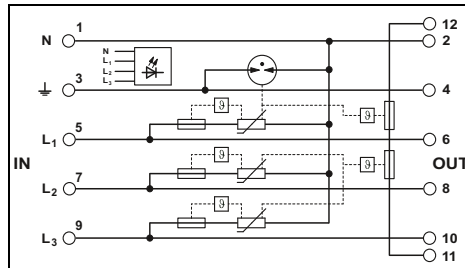

#### Technical data

Electrical data	... 230AC
IEC category / EN type	III / T3
Nominal voltage $U_N$	230 V AC (max. 240/415 V AC)
Maximum continuous operating voltage $U_C$	335 V AC (255 V AC / N-PE) / -
Nominal load current $I_L$	26 A (30 °C)
Nominal discharge surge current $I_n$ (8/20) $\mu$ s	1.5 kA (per channel)
Max. discharge surge current $I_{max}$ (8/20) $\mu$ s	10 kA (N-PE)
Combined surge $U_{OC}$	4 kV
Protection level $U_p$	L-N/L(N)-PE $\leq 1.2$ kV / $\leq 1.5$ kV
Response time $t_A$	L-N/L(N)-PE $\leq 25$ ns / $\leq 100$ ns
Backup fuse max. in acc. with IEC	25 A (gL)
General data	
Dimensions W / H / D	35.4 mm / 90 mm / 65.5 mm
Connection data solid / stranded / AWG	0.2 ... 4 mm <sup>2</sup> / 0.2 ... 2.5 mm <sup>2</sup> / 24 - 12
Temperature range	-40 °C ... 85 °C
Inflammability class in acc. with UL 94	V0
Test standards	IEC 61643-1 / EN 61643-11/A11
Remote indication contact	N/C contact
Connection data solid / stranded / AWG	0.2 ... 4 mm <sup>2</sup> / 0.2 ... 2.5 mm <sup>2</sup> / 24 - 12
Max. operating voltage	250 V
Max. operating current	3 A AC

#### Ordering data

Description	Voltage $U_N$
<b>MAINS-PLUGTRAB</b> , consisting of a plug and base element	24 V AC/DC 60 V AC 120 V AC 230 V AC 48 V DC
<b>MAINS-PLUGTRAB plug</b>	24 V AC 60 V AC 120 V AC 230 V AC 48 V DC

Type	Order No.	Pcs. / Pkt.
PT 4-PE/S-230AC/FM	2882459	5
PT 4-PE/S-230AC-ST	2882462	5

#### Accessories

<b>PLUGTRAB base element</b> , for mounting on NS 35	
<b>Grounding plug</b>	
<b>Marking material</b>	ZBF ..., see page 111

Total width 17.7 mm

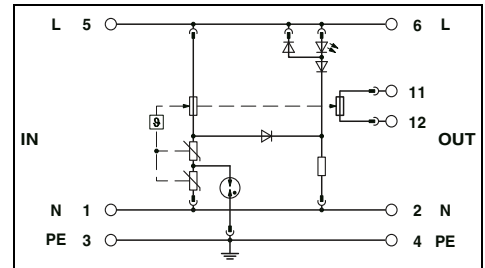

#### Technical data

... 24AC	... 60AC	... 120AC	... 230AC
III / T3	III / T3	III / T3	III / T3
24 V AC/DC	60 V AC	120 V AC	230 V AC
34 V AC / 44 V DC	100 V AC / 95 V DC	150 V AC / -	253 V AC / -
26 A (30 °C)	26 A (30 °C)	26 A (30 °C)	26 A (30 °C)
1 kA	2.5 kA	2.5 kA	3 kA
2 kV	4 kV	6 kV	6 kV
$\leq 180$ V / -	$\leq 400$ V / -	$\leq 620$ V / $\leq 850$ V	$\leq 1.1$ kV / $\leq 1.5$ kV
$\leq 25$ ns / $\leq 100$ ns	$\leq 25$ ns / $\leq 100$ ns	$\leq 25$ ns / $\leq 100$ ns	$\leq 25$ ns / $\leq 100$ ns
		25 A (gL)	
		17.7 mm / 90 mm / 65.5 mm	
		0.2 ... 4 mm <sup>2</sup> / 0.2 ... 2.5 mm <sup>2</sup> / 24 - 12	
		-40 °C ... 85 °C	
		V0	
		IEC 61643-1 / EN 61643-11/A11 / UL 1449 ed. 3	
		N/C contact	
		0.2 ... 4 mm <sup>2</sup> / 0.2 ... 2.5 mm <sup>2</sup> / 24 - 12	
		250 V	
		3 A AC	

#### Ordering data

Type	Order No.	Pcs. / Pkt.
PT 2-PE/S-24AC/FM	2800457	1
PT 2-PE/S-60AC/FM	2800961	10
PT 2-PE/S-120AC/FM	2856812	1
PT 2-PE/S-230AC/FM	2858357	1

#### Accessories

<b>PT-BE/FM</b>	2839282	10
<b>PT MAIN-EST</b>	2880736	10
<b>Marking material</b>	ZBF ..., see page 111	



Replacement connector for 3-conductor system; L, N, PE



3-conductor system; L, N, PE/L, L, PE (IT system)



3-conductor system, for single-phase DC power supply units

Total width 17.7 mm

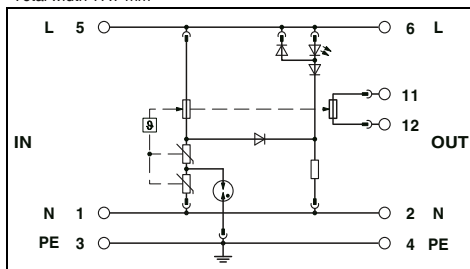

### Technical data

... 24AC	... 60AC	... 120AC	... 230AC
III / T3	III / T3	III / T3	III / T3
24 V AC	60 V AC	120 V AC	230 V AC
34 V AC / 44 V DC	100 V AC / 95 V DC	150 V AC / -	253 V AC / -
26 A (30 °C)	26 A (30 °C)	26 A (30 °C)	26 A (30 °C)
1 kA	2.5 kA	2.5 kA	3 kA
2 kV	4 kV	6 kV	6 kV
≤ 180 V / ≤ 550 V	≤ 400 V / ≤ 700 V	≤ 620 V / ≤ 850 V	≤ 1.1 kV / ≤ 1.5 kV
≤ 25 ns / ≤ 100 ns	≤ 25 ns / ≤ 100 ns	≤ 25 ns / ≤ 100 ns	≤ 25 ns / ≤ 100 ns

25 A (g/L)

17.7 mm / 45 mm / 52 mm

-

-40 °C ... 85 °C (non-EX)

V0

IEC 61643-1 / EN 61643-11/A11 / UL 1449

Total width 17.7 mm

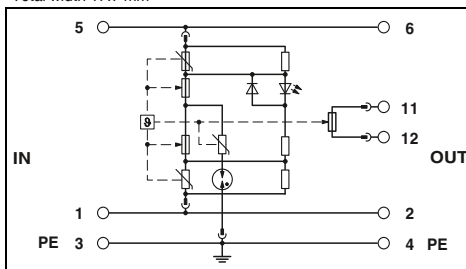

### Technical data

... 230AC
III / T3
230 V AC
275 V AC / -
26 A (30 °C)
3 kA
8 kA
6 kV
≤ 1.2 kV / ≤ 1.5 kV
≤ 25 ns / ≤ 100 ns

25 A (g/LC)

17.7 mm / 90 mm / 65.5 mm

0.2 ... 4 mm<sup>2</sup> / 0.2 ... 2.5 mm<sup>2</sup> / 24 - 12

-40 °C ... 75 °C

V0

IEC 61643-1 / EN 61643-11/A11

-

N/C contact

0.2 ... 4 mm<sup>2</sup> / 0.2 ... 2.5 mm<sup>2</sup> / 24 - 12

250 V

3 A AC/DC

Total width 17.7 mm

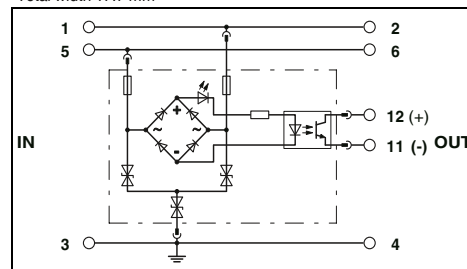

### Technical data

... 48DC
III / T3
48 V DC
- / 60 V DC -
26 A (30 °C)
500 A
500 A
6 kV (for 12 Ω)
≤ 120 V / ≤ 120 V
≤ 1 ns / ≤ 1 ns

25 A (g/L)

17.7 mm / 90 mm / 65.5 mm

0.2 ... 4 mm<sup>2</sup> / 0.2 ... 2.5 mm<sup>2</sup> / 24 - 12

-40 °C ... 85 °C

V0

IEC 61643-1 / EN 61643-11/A11 / BS 6651 /

ANSI/IEEE C62.41 / EN 50082-2

N/C contact

0.2 ... 4 mm<sup>2</sup> / 0.2 ... 2.5 mm<sup>2</sup> / 24 - 12

250 V

3 A AC

### Ordering data

Type	Order No.	Pcs. / Pkt.
PT 2-PE/S- 24AC-ST	2839318	10
PT 2-PE/S- 60AC-ST	2839321	10
PT 2-PE/S-120AC-ST	2839334	10
PT 2-PE/S-230AC-ST	2839347	10

### Accessories

Type	Order No.	Pcs. / Pkt.
PT-BE/FM	2839282	10

### Ordering data

Type	Order No.	Pcs. / Pkt.
PT 2-IT-230AC/FM	2805130	1
PT 2-IT-230AC-ST	2805127	10

### Accessories

Type	Order No.	Pcs. / Pkt.
PT-BE/FM	2839282	10
PT MAIN-EST	2880736	10

### Ordering data

Type	Order No.	Pcs. / Pkt.
PT 2+1-S-48DC/FM	2817958	10
PT 2+1-S-48DC-ST	2839648	10

### Accessories

Type	Order No.	Pcs. / Pkt.
PT-BE/FM	2839282	10
PT MAIN-EST	2880736	10

ZBF ..., see page 111

ZBF ..., see page 111

ZBF ..., see page 111

# Surge protection and interference filters

## Surge protection for the power supply unit

### Type 3 device protection BLOCKTRAB and PRINTRAB

**BT-1S-230AC/...** is device protection in deep installation boxes (in acc. with DIN 49073), cable ducts, underfloor systems, and termination devices.

- With double spring-cage terminal blocks for tool-free conductor connection
- Side latches for easy fixing
- Optical/acoustic signaling of disconnection

**BT-SKT 230/A** is device protection for UP sockets.

- Independent of the switch range and pin arrangement
- Is mounted on the socket insert
- For installation boxes as per DIN 49073
- Bridges provided for multiple combination
- Subsequent on-site installation possible
- Thermally monitored protective circuit
- Acoustic signaling of disconnection
- Signal deactivation by pulling the link under the socket cover

**MAINS-PRINTRAB** is device protection for installation in cable ducts and installation boxes.

- Two-piece design, consisting of **PRT-S-.../FM** protective connector and **PRT-CD-AD1** flush-type base
- Optical and optical/audible signaling of disconnection
- With floating remote indication contact
- Installation in range of switches with the appropriate central plate possible
- Tool-free connector replacement

<b>Notes:</b>
For certifications, see page 154



For universal mounting, optical signaling

Total width 22.5 mm

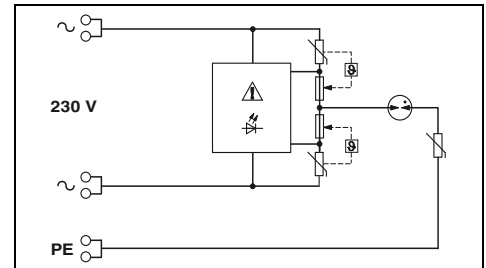

#### Technical data

Electrical data		... 230AC
IEC category / EN type		III / T3
Nominal voltage $U_N$		240 V AC
Maximum continuous operating voltage $U_C$	L-N / L-PE	275 V AC / 440 V AC (4-conductor IT system)
Nominal load current $I_L$		16 A (30 °C)
Nominal discharge surge current $I_n$ (8/20) $\mu$ s		3 kA
Max. discharge surge current $I_{max}$ (8/20) $\mu$ s	L-N / L-PE	8 kA (> 100x 1 kA) / -
Combined surge $U_{OC}$		6 kV
Protection level $U_p$	L-N/L(N)-PE	$\leq 1.3$ kV / -
Response time $t_A$	L-N/L(N)-PE	$\leq 25$ ns (L-N) / $\leq 100$ ns (L-, N-PE)
Backup fuse max. in acc. with IEC		16 A (gL/C/B)
General data		
Dimensions W / H / D		22.5 mm / 43 mm / 26.2 mm
Connection data solid / stranded / AWG		0.2 ... 2.5 mm <sup>2</sup> / 0.2 ... 2.5 mm <sup>2</sup> / 24 - 14
Temperature range		-30 °C ... 75 °C
Inflammability class in acc. with UL 94		V0
Test standards		EN 61643-11/A11 / IEC 61643-1
Remote indication contact		
Connection data solid / stranded / AWG		-
Max. operating voltage		-
Max. operating current		-

#### Ordering data

Description	Voltage $U_N$	Type	Order No.	Pcs. / Pkt.
<b>BLOCKTRAB</b> , for universal mounting	240 V AC	<b>BT-1S-230AC/O</b>	<b>2800625</b>	<b>1</b>
<b>SOCKETTRAB</b> , device protection for installation socket inserts	230 V AC			
<b>MAINS-PRINTRAB</b> , device protection plug with temperature monitoring and optical fault warning, as well as remote indication contact	120 V AC 230 V AC			
<b>MAINS-PRINTRAB</b> , device protection plug with temperature monitoring, optical and acoustic fault warning and remote indicator contact	120 V AC 230 V AC			
<b>MAINS-PRINTRAB</b> , flush-type base for installation in cable ducts and flush-type boxes	230 V AC			

#### Accessories

<b>Central plate</b>		
----------------------	--	--



For universal mounting, acoustic signaling

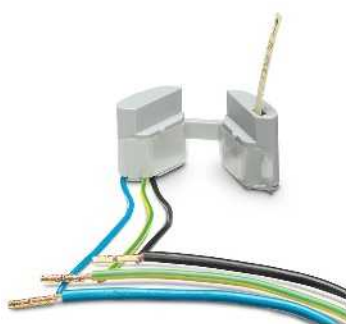

For mounting in flush-type sockets



For mounting in cable ducts and installation boxes

Total width 22.5 mm

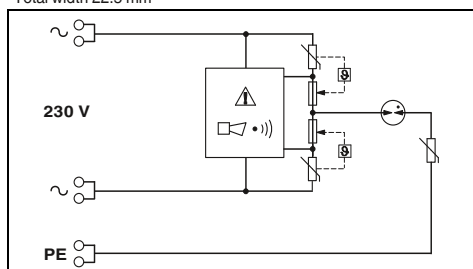

### Technical data

... 230AC  
 III / T3  
 240 V AC  
 275 V AC / 440 V AC (4-conductor IT system)  
 16 A (30 °C)  
 3 kA  
 8 kA (> 100x 1 kA) / -  
 6 kV  
 ≤ 1.3 kV / -  
 ≤ 25 ns (L-N) / ≤ 100 ns (L, N-PE)  
 16 A (gL/C/B)

22.5 mm / 43 mm / 26.2 mm  
 0.2 ... 2.5 mm<sup>2</sup> / 0.2 ... 2.5 mm<sup>2</sup> / 24 - 14  
 -25 °C ... 75 °C  
 V0  
 EN 61643-11/A11 / IEC 61643-1

-  
 -  
 -

### Ordering data

Type	Order No.	Pcs. / Pkt.
BT-1S-230AC/A	2803409	10

### Accessories

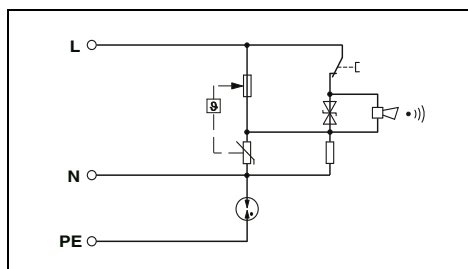

### Technical data

... 230AC  
 III / T3  
 230 V AC  
 335 V AC / -  
 16 A (30 °C)  
 1.5 kA  
 4.5 kA / 4.5 kA  
 4 kV  
 ≤ 1.3 kV / ≤ 1.5 kV  
 ≤ 25 ns / ≤ 100 ns  
 16 A (gL / B)

-  
 - ... - / - ... 1.5 mm<sup>2</sup> / -  
 -25 °C ... 75 °C  
 V0  
 EN 61643-11/A11 / IEC 61643-1

-  
 -  
 -

### Ordering data

Type	Order No.	Pcs. / Pkt.
BT-SKT 230/A	2859343	1

### Accessories

Total width 31.5 mm

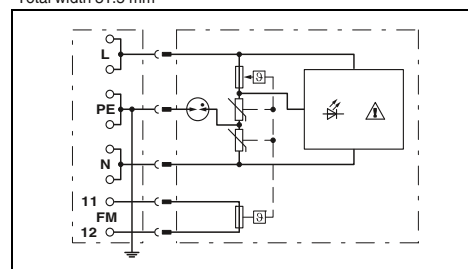

### Technical data

... 120AC	... 230AC
III / T3	III / T3
120 V AC	230 V AC
150 V AC / 150 V AC	253 V AC / 253 V AC
10 A (CSA)	16 A (45°C)
1.5 kA	1.5 kA
4.5 kA / 4.5 kA	4.5 kA / 4.5 kA
4 kV	4 kV
≤ 600 V / ≤ 800 V	≤ 1.3 kV / ≤ 1.5 kV (at U <sub>OC</sub> )
≤ 25 ns / ≤ 100 ns	≤ 25 ns / ≤ 100 ns
	16 A (gL/C)

31.5 mm / 32.7 mm / 33 mm  
 0.2 ... 4 mm<sup>2</sup> / 0.2 ... 2.5 mm<sup>2</sup> / 24 - 12  
 -25 °C ... 75 °C  
 V0  
 IEC 61643-1 / EN 61643-11/A11  
 N/C contact  
 0.14 ... 1.5 mm<sup>2</sup> / 0.14 ... 1.5 mm<sup>2</sup> / 26 - 16  
 250 V AC  
 3 A

### Ordering data

Type	Order No.	Pcs. / Pkt.
PRT-S-120/FM	2830618	10
PRT-S-230/FM	2749686	10
PRT-S/A-120/FM	2830605	1
PRT-S/A-230/FM	2830621	10
PRT-CD-AD1	2749673	25

### Accessories

ZP-J/TAE/ST550 WH	2830362	10
-------------------	---------	----

# Surge protection and interference filters

## Surge protection for the power supply unit

### Type 3 device protection MAINTRAB

- Attachment plug
- For individual termination devices
- With increased touch-proof protection
- Optical signaling of the surge voltage function via LED

Note: More information on other versions of MNT attachment plugs with combined protection for the power supply unit and the interfaces of data/information technology can be found starting on page 126.



Attachment plug



Attachment plug for Powerline transmission

### MNT-POWERLINE

- For Powerline transmission systems
- With adapted protective circuit
- Optimized attenuation behavior
- Optical signaling of the surge voltage function via LED

**Notes:**  
For certifications, see page 154

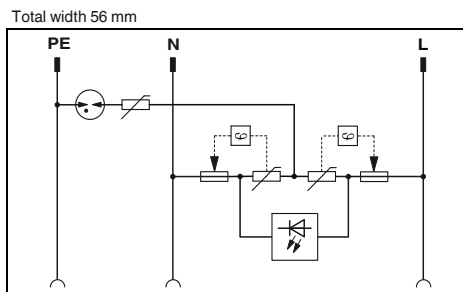

Technical data

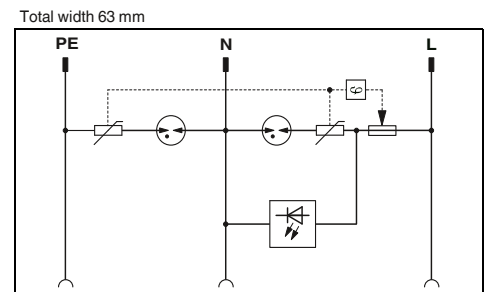

Technical data

Electrical data	
IEC category / EN type	III / T3
Nominal voltage $U_N$	230 V AC
Maximum continuous operating voltage $U_C$	L-N / L-PE 275 V AC / 360 V AC
Nominal load current $I_L$	16 A (30 °C)
Nominal discharge surge current $I_n$ (8/20) $\mu$ s	L-N / L-PE 3 kA / 3 kA
Combined surge $U_{OC}$	4 kV
Protection level $U_p$	L-N/N-PE/L-PE $\leq 1.2$ kV / $\leq 1.5$ kV / $\leq 1.5$ kV
Response time $t_A$	L-N / L-PE $\leq 25$ ns / $\leq 100$ ns
General data	
Dimensions W / H / D	56 mm / 76.3 mm / 78.2 mm
Temperature range	-25 °C ... 75 °C
Inflammability class in acc. with UL 94	V0/HB
Test standards	EN 61643-11/A11 / IEC 61643-1 / VDE 0620-1 / SEK SS 428 08 34 / IEC 60884-1 / NEK-HD 195 S6

Technical data		
IEC category / EN type	III / T3	
Nominal voltage $U_N$	230 V AC	
Maximum continuous operating voltage $U_C$	260 V AC / 260 V AC	
Nominal load current $I_L$	16 A (30 °C)	
Nominal discharge surge current $I_n$ (8/20) $\mu$ s	3 kA / 3 kA	
Combined surge $U_{OC}$	6 kV	
Protection level $U_p$	L-N/N-PE/L-PE $\leq 1.1$ kV / $\leq 1.5$ kV / $\leq 1.5$ kV	
Response time $t_A$	L-N / L-PE $\leq 25$ ns / $\leq 100$ ns	
General data		
Dimensions W / H / D	63 mm / 79 mm / 103.5 mm	
Temperature range	-25 °C ... 75 °C	
Inflammability class in acc. with UL 94	V0/HB	
Test standards	IEC 61643-1 / EN 61643-11/A11 / IEC 60884-1 / DIN VDE 0620-1	

Description		For country-specific use in
<b>MAINTRAB</b> , attachment plug with signal lamp for plugging into a socket, for device protection		
Black		D, A, NL
White		D, A, NL
Black		B, F, CZ, SVK, PL
Black		E, P
White		S, FIN, N
Black		CH
<b>MAINTRAB-POWERLINE</b> , attachment plug with signal lamp for use in Powerline transmission systems		
Black		D, A, NL, E, P

Ordering data		
Type	Order No.	Pcs. / Pkt.
MNT-1 D	2882200	1
MNT-1 D/WH	2882213	1
MNT-NET B/F	2882226	1
MNT-1 E	2882239	1
MNT-1 S/WH	2880862	1
MNT-1 CH II	2882255	1

Ordering data		
Type	Order No.	Pcs. / Pkt.
MNT-POWERLINE	2858001	1

## TRABTECH wiring bridges

- For combinations of lightning and surge arresters
- In combination with other devices in the installation distributor, such as residual current circuit breakers and miniature circuit breakers
- Practical wiring of all common applications
- Single, three or four-phase versions with various numbers of positions
- The rated cross section of the MPB bridge metals is 16 mm<sup>2</sup> per phase
- End covers are used to terminate and insulate individually cut bridges



		Ordering data		
Description	Nominal current I <sub>N</sub>	Type	Order No.	Pcs. / Pkt.
<b>Wiring bridge</b> , for modules with 17.5 mm connecting pitch, 1-phase				
2-pos.	100 A	MPB 18/1- 2	2809209	10
3-pos.	100 A	MPB 18/1- 3	2809212	10
4-pos.	100 A	MPB 18/1- 4	2809225	10
5-pos.	100 A	MPB 18/1- 5	2817864	10
6-pos.	100 A	MPB 18/1- 6	2748564	10
7-pos.	100 A	MPB 18/1- 7 BU	2856278	10
8-pos.	100 A	MPB 18/1- 8 BU	2858470	10
8-pos.	100 A	MPB 18/1- 8	2748577	10
9-pos.	100 A	MPB 18/1- 9	2748580	10
12-pos.	100 A	MPB 18/1-12	2748593	10
57-pos.	100 A	MPB 18/1-57	2809238	1
<b>Wiring bridge</b> , for modules with 17.5 mm connecting pitch, 3-phase				
6-pos.	80 A	MPB 18/3- 6	2809241	10
9-pos.	80 A	MPB 18/3- 9	2809254	10
<b>Wiring bridge</b> , for modules with 17.5 mm connecting pitch, 4-phase				
8-pos.	80 A	MPB 18/4- 8	2809283	10
12-pos.	80 A	MPB 18/4-12	2809296	10
<b>Wiring bridge</b> , flexible, diameter 16 mm <sup>2</sup> , fork-type cable lug on one side				
200 mm	100 A (30 °C)	MPB F200X16/ 1GS	2818339	1
400 mm	100 A (30 °C)	MPB F400X16/ 1GS	2818342	1
600 mm	100 A (30 °C)	MPB F600X16/ 1GS	2818355	1

# Surge protection and interference filters

## Surge protection for the power supply unit

### Feed-through terminal block

- Biconnect feed-through terminal block
- For wiring mixed combinations of lightning and surge arresters
- As a system extension for FLASHTRAB and VALVETRAB applications

**Notes:**  
For certifications, see page 154



Feed-through terminal block

<b>Electrical data</b>	
Maximum continuous operating voltage $U_c$	500 V AC/DC
Nominal current $I_N$	125 A (30 °C)
Lightning test curr. $I_{imp}$ (10/350) $\mu$ s	Peak value 100 kA
<b>General data</b>	
Dimensions W / H / D	17.7 mm / 89.8 mm / 65.5 mm
Connection data solid / stranded / AWG	35 ... 0.5 mm <sup>2</sup> / 0.5 ... 25 mm <sup>2</sup> / 20 - 2
Temperature range	-40 °C ... 85 °C
Inflammability class in acc. with UL 94	V0
Test standards	IEC 60947-7-1 / IEC 60947-7-1 / IEC 60947-7-1

### Technical data

<b>Technical data</b>		
500 V AC/DC		
125 A (30 °C)		
Peak value 100 kA		
17.7 mm / 89.8 mm / 65.5 mm		
35 ... 0.5 mm <sup>2</sup> / 0.5 ... 25 mm <sup>2</sup> / 20 - 2		
-40 °C ... 85 °C		
V0		
IEC 60947-7-1 / IEC 60947-7-1 / IEC 60947-7-1		

<b>Description</b>
<b>Feed-through terminal block</b>

### Ordering data

Type	Order No.	Pcs. / Pkt.
DK-BIC-35	2749880	1

<b>Marking material</b>
-------------------------

### Accessories

ZBN 18 ..., see page 63

### Equipotential bonding

- Equipotential bonding strip for main equipotential bonding according to DIN VDE 0100
- As well as for lightning protection equipotential bonding in acc. with DIN EN 62305
- Has a comb-shaped contact bar

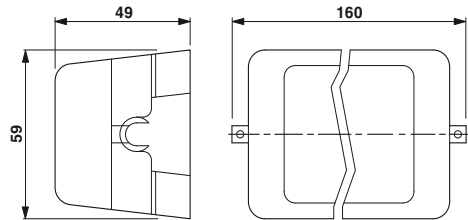

Equipotential bonding strip

<b>Description</b>
<b>Equipotential bonding strip</b>

### Ordering data

Type	Order No.	Pcs. / Pkt.
PAS-1	2765615	1



### Labeling material

- Flat zack marker strips
- Comprising five individual labels with 17.5 mm pitch.
- Can be labeled with CMS computer marking system or by hand using B-STIFT

PRINTED  
FOR YOU



Description
<b>Marking labels</b> Can be labeled acc. to customer specifications <b>unprinted</b> L1, L2, L3, N, PE 17.5 mm pitch
<b>Zack marker sheet, flat, 120-section, can be separated</b>  Can be labeled acc. to customer specifications <b>unprinted</b> <b>Zack marker strip, flat, 5-section, without color print</b> 5-section

Ordering data		
Type	Order No.	Pcs. / Pkt.
ZBN 18 CUS	0825059	1
ZBN 18:UNBEDRUCKT	2809128	10
ZBN 18,LGS:L1-N,ERDE	2749576	10
ZBN 18,LGS:ERDE	2749589	10
ZBFM 5 CUS	0825037	1
ZBFM 5/WH:UNBEDRUCKT	0803595	10
ZBF 12:UNBEDRUCKT	0809735	10

### TRABTECH housing

- For separate installation of surge protective devices
- Use in harsh environmental conditions at the installation location
- Installation outdoors or indoors possible
- Aluminum housing equipped with two cable glands
- Supplied as standard: an NS 35/7.5 DIN rail
- The DIN rail requires five part width sections of 17.5 mm each

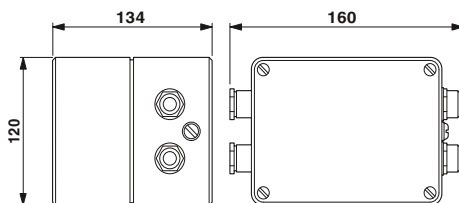

IP65 protection class

Description
<b>TRABTECH housing, for the isolated mounting of surge arresters</b>

Ordering data		
Type	Order No.	Pcs. / Pkt.
TG 40	2788896	1

# Surge protection and interference filters

## Renewable energy sources

### Lightning and surge arresters for PV systems

- Type 1 and type 2 consistent plug-in arresters
- Reliable contact, thanks to integrated rotating latch
- Optical, mechanical status indication for the individual arresters
- With or without floating remote indication contact
- Mechanical keying of all slots

**Notes:**  
For certifications, see page 154

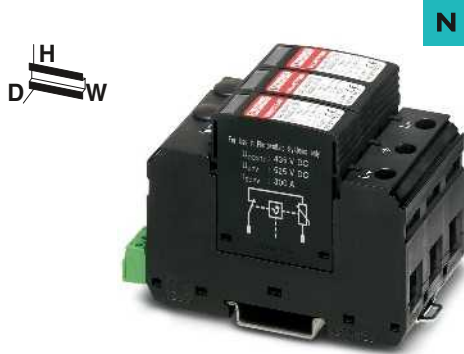

**Type 1/2 arrester for insulated and single-sided grounded PV applications**

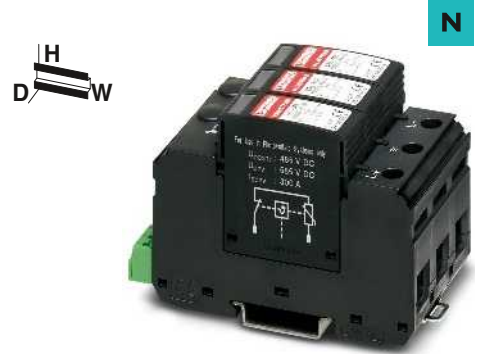

**Type 2 arrester for insulated and single-sided grounded PV applications**

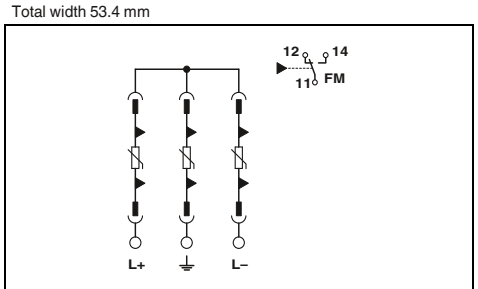
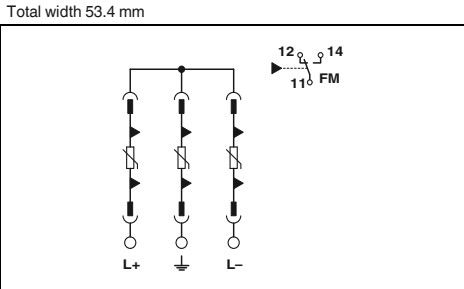

Electrical data	
IEC category / EN type	(L+) - (L-) / (L+/L-) - PE
Nominal discharge surge current $I_n$ (8/20) $\mu$ s	
Max. discharge surge current $I_{max}$ (8/20) $\mu$ s	
Protection level $U_p$	
Non-load voltage $U_{OCSTC}$	
Highest continuous voltage $U_{CPV}$	
Immunity to short-circuiting $I_{SCPV}$	
Response time tA:	
General data	
Dimensions W / H / D	
Connection data solid / stranded / AWG	
Temperature range	
Degree of protection in acc. with IEC 60529/ EN 60529	
Housing material	
Inflammability class in acc. with UL 94	
Test standards	
Remote indication contact	
Connection data solid / stranded / AWG	
Max. operating voltage	
Max. operating current	

Technical data	
... 1000 DC PV-T1 / PV-T2	... 600 DC PV-T1 / PV-T2
15 kA	15 kA
40 kA	40 kA
$\leq 3.5$ kV / $\leq 3.5$ kV	$\leq 2.6$ kV / $\leq 2.6$ kV
$\leq 875$ V DC	$\leq 600$ V DC
1050 V DC	720 V DC
300 A	300 A
$\leq 25$ ns	$\leq 25$ ns
53.4 mm / 99 mm / 65.5 mm	
1.5 ... 35 mm <sup>2</sup> / 1.5 ... 25 mm <sup>2</sup> / 15 - 2	
-40 °C ... 80 °C	
IP20	
PBT / PA	
V0	
EN 50539-11	
PDT, 1-pos.	
0.14 ... 1.5 mm <sup>2</sup> / 0.14 ... 1.5 mm <sup>2</sup> / 30 - 14	
250 V AC / 30 V	
1.5 A AC (250 V AC) / 1 A DC (30 V DC)	

Technical data	
... 1000 DC PV-T2 /	... 600 DC PV-T2 /
15 kA	15 kA
40 kA	40 kA
$\leq 3.7$ kV / $\leq 3.7$ kV	$\leq 2.7$ kV / $\leq 2.7$ kV
$\leq 970$ V DC	$\leq 670$ V DC
1170 V DC	800 V DC
300 A	300 A
$\leq 25$ ns	$\leq 25$ ns
53.4 mm / 99 mm / 65.5 mm	
1.5 ... 35 mm <sup>2</sup> / 1.5 ... 25 mm <sup>2</sup> / 15 - 2	
-40 °C ... 80 °C	
IP20	
PBT / PA	
V0	
EN 50539-11	
PDT, 1-pos.	
0.14 ... 1.5 mm <sup>2</sup> / 0.14 ... 1.5 mm <sup>2</sup> / 30 - 14	
250 V AC / 30 V	
1.5 A AC (250 V AC) / 1 A DC (30 V DC)	

Description
<b>VALVETRAB-MS</b>
with remote indication contact
without remote indication contact
with remote indication contact
without remote indication contact
Replacement connector
1000 V DC
600 V DC
Labeling material

Ordering data			
Type	Order No.	Pcs. / Pkt.	
VAL-MS-T1/T2 1000DC-PV/2+V-FM	2801161	1	
VAL-MS-T1/T2 1000DC-PV/2+V	2801160	1	
VAL-MS-T1/T2 600DC-PV/2+V-FM	2801164	1	
VAL-MS-T1/T2 600DC-PV/2+V	2801163	1	
Accessories			
VAL-MS-T1/T2 1000DC-PV-ST	2801162	1	
VAL-MS-T1/T2 600DC-PV-ST	2801165	1	

ZBN 18 ..., see page 63

Ordering data			
Type	Order No.	Pcs. / Pkt.	
VAL-MS 1000DC-PV/2+V-FM	2800627	1	
VAL-MS 1000DC-PV/2+V	2800628	1	
VAL-MS 600DC-PV/2+V-FM	2800641	1	
VAL-MS 600DC-PV/2+V	2800642	1	
Accessories			
VAL-MS 1000DC-PV-ST	2800624	1	
VAL-MS 600DC-PV-ST	2800623	1	

ZBN 18 ..., see page 63

### Set solution for building installation

- Surge protection set for powerful basic protection
- Coordinated protective devices
- VAL-MS-T1/T2 lightning arrester for installation in the distribution
- Three device protection adapters (type 3) for protecting the power supply
- Two of these are equipped with additional signal line protection (TV/SAT or TAE)
- Cables and adapters are supplied as standard



Set solution with surge protection for TAE and TV-SAT

Ordering data			
Description	Type	Order No.	Pcs. / Pkt.
<b>Building set</b> , consisting of: 1 x VAL-MS-T1/T2 (surge arrester), 1 x MNT-1D (device protection adapter), 1 x MNT-TV-SAT D (device and TV-SAT protective adapter), 1 x MNT-TAE D (device and TAE protective adapter), 2 x adapter F to TV (IEC) connector, 1 x KBL TV-SAT/150, 1 x KBL TV/150, 1 x KBL TAE/150 (connecting cable)	GEB-SET-T1/T2 TAE/TV-SAT	2801022	1

# Surge protection and interference filters

## Set solutions

### Surge protection for photovoltaic systems

- For insulated or grounded PV applications up to 1000 V DC
- Pre-assembled protection solutions
- Suitable for DC applications such as PV systems
- Type 1/2 universally plug-in capable lightning arresters and surge arresters
- Optical, mechanical status indication for the individual arresters
- Mechanical keying of all slots
- Connectors can be checked with CHECKMASTER

**Notes:**  
For certifications, see page 154



For insulated or grounded PV applications up to 1000 V DC, with SUNCLIX

Total width 125 mm

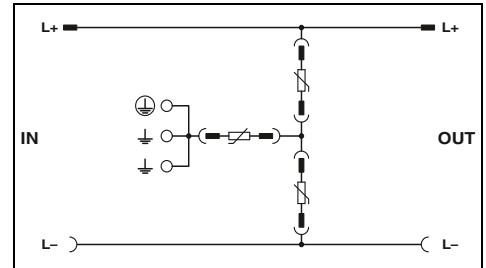

#### Technical data

Electrical data	
IEC category / EN type	PV-T1 / PV-T2
Lightning test curr. $I_{mp}$ (10/350) $\mu$ s	Peak value
Nominal discharge surge current $I_n$ (8/20) $\mu$ s	5 kA
Max. discharge surge current $I_{max}$ (8/20) $\mu$ s	15 kA
Protection level $U_p$	40 kA
Highest continuous voltage $U_{CPV}$	(L+) - (L-) / (L+/L-) - PE $\leq 3.5$ kV / $\leq 3.5$ kV
Immunity to short-circuiting $I_{SCP}$	1000 V DC
Response time $t_A$ :	32 A DC
General data	
Dimensions W / H / D	125 mm / 200 mm / 122 mm
Temperature range	-30 °C ... 55 °C
Degree of protection in acc. with IEC 60529/ EN 60529	IP65
Housing material	Polycarbonate, glass-fiber-reinforced
Inflammability class in acc. with UL 94	V2 (housing/cover)
Test standards	IEC 61439-2 / EN 61439-2 / prEN 50539-11
Remote indication contact	PDT, 1-pos.
Connection data solid / stranded / AWG	0.14 ... 1.5 mm <sup>2</sup> / 0.14 ... 1.5 mm <sup>2</sup> / 28 - 16
Max. operating voltage	250 V AC / 30 V DC
Max. operating current	1.5 A AC (250 V AC) / 1.5 A DC (30 V DC)

#### Ordering data

Description	Type	Order No.	Pcs. / Pkt.
Surge protection in IP65 housing, for photovoltaic systems up to 1000 V DC (L+)-PE & (L-)-PE & (L+)-(L-)	PV-SET 1ST/1000DC/1MPP-SPD-SC	2801529	1

#### Accessories

Replacement connector	Accessories	Order No.	Pcs. / Pkt.
	VAL-MS-T1/T2 1000DC-PV-ST	2801162	1



For two MPP trackers, up to 1000 V DC, with SUNCLIX



For three MPP trackers, up to 1000 V DC, with SUNCLIX



For two solar strings, including a generator disconnect

Total width 200 mm

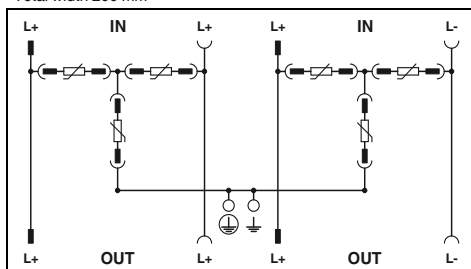

Technical data

PV-T1 / PV-T2

5 kA  
15 kA  
40 kA

≤ 3.5 kV / ≤ 3.5 kV  
1000 V DC  
32 A DC (per MPP)  
≤ 25 ns

200 mm / 200 mm / 122 mm  
-30 °C ... 55 °C  
IP65  
Polycarbonate, glass-fiber-reinforced  
V2 (housing/cover)  
IEC 61439-2 / EN 61439-2 / prEN 50539-11  
PDT, 1-pos.  
0.14 ... 1.5 mm<sup>2</sup> / 0.14 ... 1.5 mm<sup>2</sup> / 28 - 16  
250 V AC / 30 V DC  
1.5 A AC (250 V AC) / 1.5 A DC (30 V DC)

Total width 300 mm

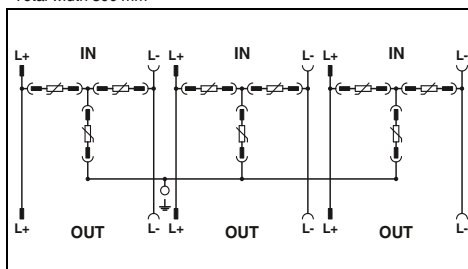

Technical data

PV-T1 / PV-T2

5 kA  
15 kA  
40 kA

≤ 3.5 kV / ≤ 3.5 kV  
1000 V DC  
32 A DC (per MPP)  
≤ 25 ns

300 mm / 300 mm / 142 mm  
-30 °C ... 55 °C  
IP65  
Polycarbonate, glass-fiber-reinforced  
V2 (housing/cover)  
IEC 61439-2 / EN 61439-2 / prEN 50539-11  
PDT, 1-pos.  
0.14 ... 1.5 mm<sup>2</sup> / 0.14 ... 1.5 mm<sup>2</sup> / 28 - 16  
250 V AC / 30 V DC  
1.5 A AC (250 V AC) / 1.5 A DC (30 V DC)

Total width 200 mm

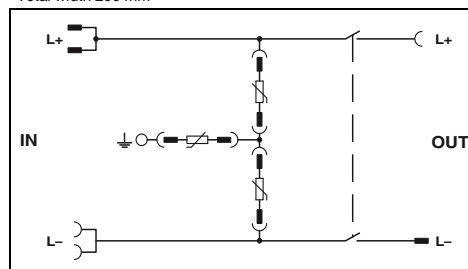

Technical data

PV-T1 / PV-T2

5 kA  
15 kA  
40 kA

≤ 3.5 kV / ≤ 3.5 kV  
1000 V DC  
32 A DC  
≤ 25 ns

200 mm / 200 mm / 122 mm  
-20 °C ... 40 °C  
IP65  
Polycarbonate, glass-fiber-reinforced  
V2 (housing/cover)  
prEN 50539-11 / EN 61439-2  
PDT, 1-pos.  
0.14 ... 1.5 mm<sup>2</sup> / 0.14 ... 1.5 mm<sup>2</sup> / 28 - 16  
250 V AC / 30 V DC  
1.5 A AC (250 V AC) / 1.5 A DC (30 V DC)

Ordering data

Type	Order No.	Pcs. / Pkt.
PV-SET 2ST/1000DC/2MPP-SPD-SC	2801317	1

Accessories

VAL-MS-T1/T2 1000DC-PV-ST	2801162	1
---------------------------	---------	---

Ordering data

Type	Order No.	Pcs. / Pkt.
PV-SET 3ST/1000DC/3MPP-SPD-SC	2801531	1

Accessories

VAL-MS-T1/T2 1000DC-PV-ST	2801162	1
---------------------------	---------	---

Ordering data

Type	Order No.	Pcs. / Pkt.
PV-SET 2ST/1000DC-SPD-SD-SC	2801318	1

Accessories

VAL-MS-T1/T2 1000DC-PV-ST	2801162	1
---------------------------	---------	---

# Surge protection and interference filters

## NEMA set solutions

### Device protection for components

- Protects AC power mains
- 50 kA direct lightning strike energy
- Combination lightning arrester and TVSS
- Revolutionary Arc Chopping Spark Gap technology
- Extinguishes up to 50 kA of follow current
- Remote status contacts
- Status LED lamps available
- ETL listed to UL 1449, 3rd edition



120/240 V single/split phase system



120/208Y system

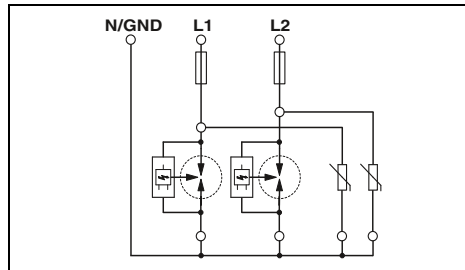

Technical data

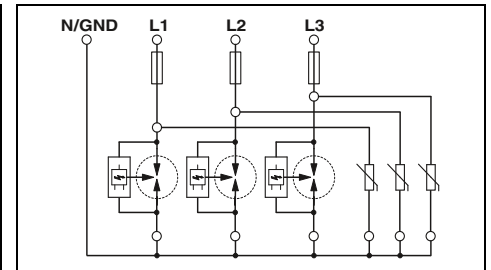

Technical data

MCOV		275 V		275 V
Nominal voltage $U_N$		< 240 V		< 240 V
Lightning test curr. $I_{imp}$ (10/350) $\mu$ s		50 kA (per mode)		50 kA (per mode)
Response time $t_A$		$\leq 25$ ns		$\leq 25$ ns
Voltage Protection Rating (VPR)				
Short-circuit current rating (SCCR)	L-L / L-PE	1500 V / 900 V		1500 V / 900 V
UL Type		50 kA		50 kA
Connection data solid / stranded / AWG		Type 2		Type 2
Error/status indicator		10 ... 50 mm <sup>2</sup> / 16 ... 35 mm <sup>2</sup> / 6 - 1		10 ... 50 mm <sup>2</sup> / 16 ... 35 mm <sup>2</sup> / 6 - 1
Temperature range		Remote indicator contact		Remote indicator contact
Dimensions	W / H / D	-40 °C ... 80 °C		-40 °C ... 80 °C
Test standards		400 mm / 500 mm / 210 mm		400 mm / 500 mm / 210 mm
		UL 1449 3 <sup>rd</sup> edition, Sept. 2009 / IEC 60643-1 / EN 61643-11		UL 1449 3 <sup>rd</sup> edition, Sept. 2009 / IEC 60643-1 / EN 61643-11
		CAN/CSA-C22.2 No. 8		CAN/CSA-C22.2 No. 8

Ordering data

Ordering data

Description	Ordering data			Ordering data		
	Type	Order No.	Pcs. / Pkt.	Type	Order No.	Pcs. / Pkt.
<b>SYSTEMTRAB</b> arrester and TVSS system						
IP66 / NEMA 4 cabinet	<b>SYS N4 120/240S</b>	<b>2800705</b>	1	<b>SYS N4 120/208Y</b>	<b>2800704</b>	1
IP66 / NEMA 4 cabinet with indicator lamps	<b>SYS N4/I 120/240S</b>	<b>2800710</b>	1	<b>SYS N4/I 120/208Y</b>	<b>2800709</b>	1
IP66 / NEMA 4X cabinet	<b>SYS N4X 120/240S</b>	<b>2800715</b>	1	<b>SYS N4X 120/208Y</b>	<b>2800714</b>	1
IP66 / NEMA 4X cabinet with indicator lamps	<b>SYS N4X/I 120/240S</b>	<b>2800720</b>	1	<b>SYS N4X/I 120/208Y</b>	<b>2800719</b>	1



277/480Y system



240 V High-Leg Delta



480 V Delta system

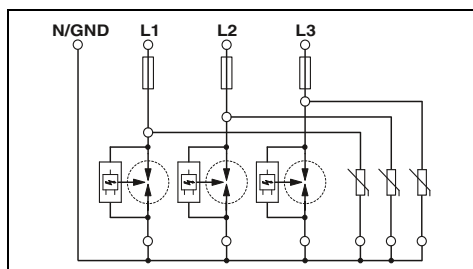

Technical data

- / 600 V (L-L) / 440 V (L-G)  
 < 277 V  
 50 kA (per mode)  
 ≤ 25 ns

2500 V / 1500 V  
 50 kA  
 Type 2  
 10 ... 50 mm<sup>2</sup> / 16 ... 35 mm<sup>2</sup> / 6 - 1  
 Remote indicator contact  
 -40 °C ... 80 °C  
 400 mm / 500 mm / 210 mm  
 UL 1449 3<sup>rd</sup> edition, Sept. 2009 / IEC 60643-1 /  
 EN 61643-11  
 CAN/CSA-C22.2 No. 8

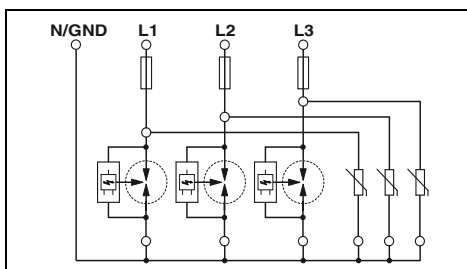

Technical data

275 V  
 < 240 V  
 50 kA (per mode)  
 ≤ 25 ns

1500 V / 900 V  
 50 kA  
 Type 2  
 10 ... 50 mm<sup>2</sup> / 16 ... 35 mm<sup>2</sup> / 6 - 1  
 Remote indicator contact  
 -40 °C ... 80 °C  
 400 mm / 500 mm / 210 mm  
 UL 1449 3<sup>rd</sup> edition, Sept. 2009 / IEC 60643-1 / EN 61643-11 /  
 CAN/CSA-C22.2 No. 8

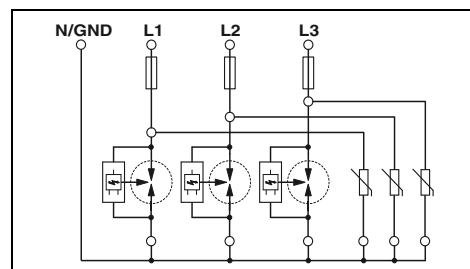

Technical data

- / 600 V (L-L) / 480 V (L-G)  
 < 480 V  
 50 kA (per mode)  
 ≤ 25 ns

2500 V / 1500 V  
 50 kA  
 Type 2  
 10 ... 50 mm<sup>2</sup> / 16 ... 35 mm<sup>2</sup> / 6 - 1  
 Remote indicator contact  
 -40 °C ... 80 °C  
 400 mm / 500 mm / 210 mm  
 UL 1449 3<sup>rd</sup> edition, Sept. 2009 / IEC 60643-1 / EN 61643-11 /  
 CAN/CSA-C22.2 No. 8

Ordering data

Type	Order No.	Pcs. / Pkt.
SYS N4 277/480Y	2800703	1
SYS N4/I 277/480Y	2800708	1
SYS N4X 277/480Y	2800713	1
SYS N4X/I 277/480Y	2800718	1

Ordering data

Type	Order No.	Pcs. / Pkt.
SYS N4 120/240HLD	2800706	1
SYS N4/I 120/240HLD	2800711	1
SYS N4X 120/240HLD	2800716	1
SYS N4X/I 120/240HLD	2800721	1

Ordering data

Type	Order No.	Pcs. / Pkt.
SYS N4 480D	2800707	1
SYS N4/I 480D	2800712	1
SYS N4X 480D	2800717	1
SYS N4X/I 480D	2800722	1



### Intelligent and systematic surge protection – PLUGTRAB PT-IQ

The PLUGTRAB PT-IQ product range is the first to offer predictive function monitoring for surge protective devices in the context of measurement and control technology. Boasting a whole range of additional features, the new surge protection system is a real highlight from Phoenix Contact.

### Always know what is happening – predictive monitoring

The individual components of the protective devices are permanently monitored. When the performance limit has been reached as a result of frequent surge voltages, this is indicated by the yellow status symbol. The arrester continues to function and your system is still protected. However, replacement of the protective plug is recommended. This ensures you are informed even earlier and can replace your surge protection before the protective plug is overloaded (red signal). Furthermore, if you use the remote signaling option, you can check how well your system is being protected from anywhere and at any time.

### Permanent and error-free installation

The PLUGTRAB PT-IQ minimizes the amount of wiring required. This is made possible by the DIN rail connector (TBUS), which is easily clipped onto the DIN rail. A controller handles the distribution of the power supply and implements remote signaling of all connected surge protective devices via the TBUS. All you have to do then is install the surge protective devices on the TBUS – and you're done! The plug and base element are coded to avoid installation errors during replacement.

### Limitless extension

The controller monitors all arresters which are connected to the controller via the TBUS. You can bridge the TBUS across DIN rails to monitor even more protective devices. After 28 protective devices, an additional controller must be installed to supply voltage. Remote signaling can be performed from any controller in the system.

### Other surge protective devices

PLUGTRAB PT are plug-in arresters without remote signaling, also with switching variants for intrinsically safe signal circuits.

The multi-stage modular terminal blocks in the TERMITRAB or LINETRAB product ranges have a design width of just 6.2 mm yet are able to offer protection for up to four signal wires.

As they are installed directly on measuring sensors, the SURGETRAB screw connection modules are able to provide reliable protection against transients even in EX-i and Ex-d applications.

The products in the COMTRAB modular range have been designed specifically for use in marshalling distributors.





### Group message

Green: protective device OK  
 Yellow: performance limit reached, replacement recommended  
 Red: protective device overloaded, replace



### Multi-level remote signaling

Connect the remote signaling to the controller that acts as a supply and remote module (one-off connection operation). The status is output according to the priority as red, yellow or green. This ensures you always know what is happening and can always keep an eye on your system's protection.



### TBUS DIN rail connector

The DIN rail connector (TBUS) supplies voltage to the protection modules and forwards the status of each individual arrester to the controller. You benefit from the reduced wiring costs and can implement surge protection quickly without errors.

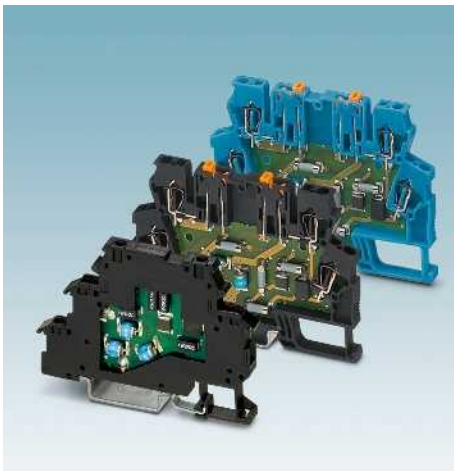

### Narrow arresters

The narrow TERMITRAB modular terminal blocks have a design width of just 6.2 mm. Some offer multi-stage protective circuits for Ex and non-Ex applications.



### Special systems

Implement protection in the field directly at the measuring sensor with SURGETRAB screw connection modules.



### Versions for terminal strips

COMTRAB modular type protective devices are used for highly compressed cable networks like those found in marshalling distributors, for example.

# Surge protection and interference filters

## Surge protection for measurement and control technology

### PLUGTRAB PT-IQ with screw connection

- Surge protection system
- Multi-level state monitoring
- Collective message about supply and remote module
- Multi-level, floating remote signaling
- System supplied via DIN rail bus
- Up to 28 protection modules per supply module
- Maximum ease of maintenance thanks to the two-piece design
- Plugs are coded
- Impedance-neutral disconnection of plug for maintenance purposes
- Base element remains an integral part of the installation
- Base element with screw connection technology

**Notes:**  
For certifications, see page 154

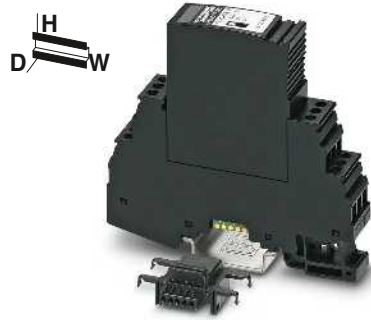

Controller for supply and remote signaling

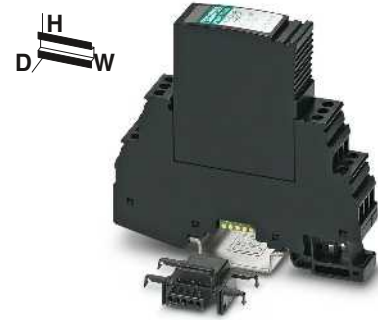

Double conductor (loop), floating, 9/10 connection grounded directly

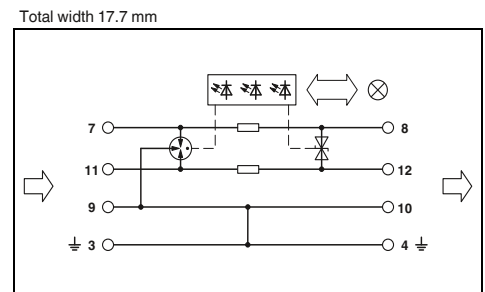
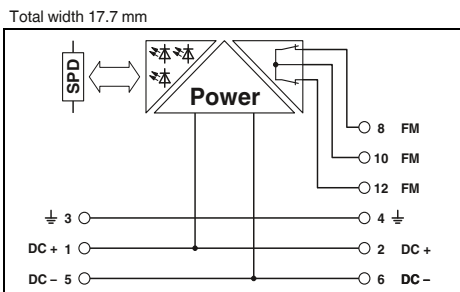

#### Technical data

Electrical data	
IEC category / EN type	-
Maximum continuous operating voltage $U_c$	DC/AC -
Lightning test curr. $I_{imp}$ (10/350) $\mu$ s	Per path -
Nominal current $I_N$	max. 130 mA (24 V DC)
Nominal discharge surge current $I_n$ (8/20) $\mu$ s	-
Total surge current (8/20) $\mu$ s	Core-Core / Core-Ground -
Protection level $U_p$	Core-Core -
	Core-Ground -
Resistance per path	-
General data	
Dimensions W / H / D	17.7 mm / 91.1 mm / 77.5 mm
Connection data solid/stranded with ferrule/ AWG	0.2 ... 4 mm <sup>2</sup> / 0.2 ... 2.5 mm <sup>2</sup> / 24 - 12
Temperature range	-40 °C ... 70 °C
Degree of protection in acc. with IEC 60529/ EN 60529	IP20
Inflammability class in acc. with UL 94	V0
Test standards	EN 61000-6-2 / EN 61000-6-2/A1 / EN 61000-6-3
Remote indication contact	
Connection data solid/stranded	2 x N/C contacts
Max. operating voltage	0.2 ... 4 mm <sup>2</sup> / 24 - 14
Max. operating current	30 V AC (50 - 60 Hz) / 50 V DC
	1 A (up to 50°C) / 200 mA (up to 70°C)

#### Ordering data

Description	Voltage $U_N$
<b>PLUGTRAB supply module</b> , consisting of a plug, base element, and DIN rail bus	24 V DC
<b>MCR-PLUGTRAB</b> , consisting of a plug, base element, and DIN rail bus	5 V DC 12 V DC 24 V DC 48 V DC

Type	Order No.	Pcs. / Pkt.
PT-IQ-PTB-UT	2800768	1

#### Accessories

Replacement connector
5 V DC
12 V DC
24 V DC
48 V DC

Type	Order No.	Pcs. / Pkt.
PT-IQ-PTB-P	2800989	1

ZB 6, see page 111

#### Technical data

... 5DC	... 12DC	... 24DC	... 48DC
C1 / C2 / C3 / D1	C1 / C2 / C3 / D1	C1 / C2 / C3 / D1	C1 / C2 / C3 / D1
6 V DC / 4 V AC	15 V DC / 10 V AC	30 V DC / 21 V AC	53 V DC / 37 V AC
2.5 kA	2.5 kA	2.5 kA	2.5 kA
1000 mA (Up to 45°C)	1000 mA (Up to 45°C)	1000 mA (Up to 45°C)	300 mA (Up to 45°C)
10 kA / 10 kA	10 kA / 10 kA	10 kA / 10 kA	10 kA / 10 kA
20 kA	20 kA	20 kA	20 kA
$\leq 25$ V (C3 - 25 A)	$\leq 35$ V (C3 - 25 A)	$\leq 55$ V (C3 - 25 A)	$\leq 90$ V (C3 - 25 A)
$\leq 600$ V (C1 - 1 kV/500 A)	$\leq 600$ V (C1 - 1 kV/500 A)	$\leq 600$ V (C1 - 1 kV/500 A)	$\leq 600$ V (C1 - 1 kV/500 A)
1.2 $\Omega$	1.2 $\Omega$	1.2 $\Omega$	1.2 $\Omega$
17.7 mm / 91.1 mm / 77.5 mm			
0.2 ... 4 mm <sup>2</sup> / 0.2 ... 2.5 mm <sup>2</sup> / 24 - 12			
-40 °C ... 70 °C			
IP20			
V0			
EN 61643-21/A1 / IEC 61643-21/A1 / EN 61000-6-2 / EN 61000-6-2/A1 / EN 61000-6-3			
Via TBUS			

#### Ordering data

Type	Order No.	Pcs. / Pkt.
PT-IQ-1X2-5DC-UT	2800791	1
PT-IQ-1X2-12DC-UT	2800793	1
PT-IQ-1X2-24DC-UT	2800976	1
PT-IQ-1X2-48DC-UT	2800978	1

#### Accessories

Type	Order No.	Pcs. / Pkt.
PT-IQ-1X2-5DC-P	2800770	1
PT-IQ-1X2-12DC-P	2800771	1
PT-IQ-1X2-24DC-P	2800772	1
PT-IQ-1X2-48DC-P	2800773	1

ZB 6, see page 111

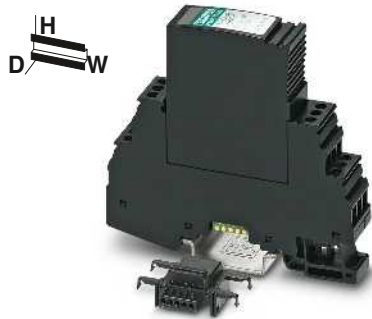

Double conductor (loop), floating,  
9/10 connection grounded via gas-filled surge  
arrester

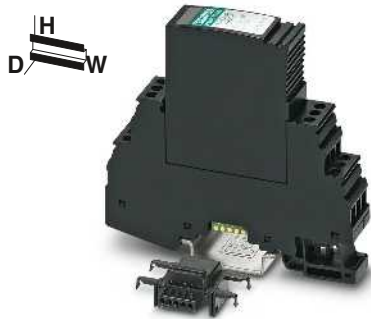

2-wire with common reference potential,  
9/10 connection grounded directly

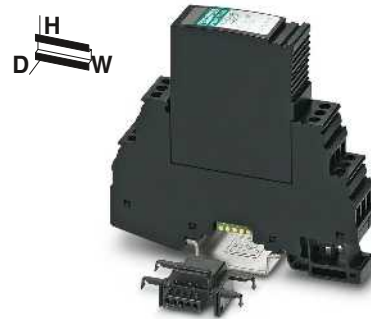

2-wire with common reference potential,  
9/10 connection grounded via gas-filled surge  
arrester

Total width 17.7 mm

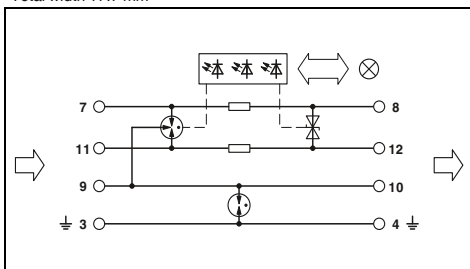

Total width 17.7 mm

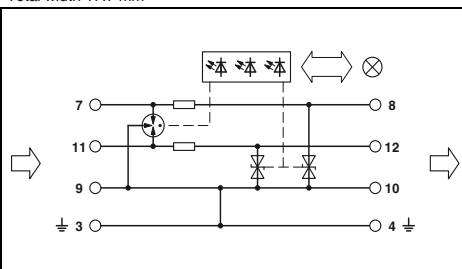

Total width 17.7 mm

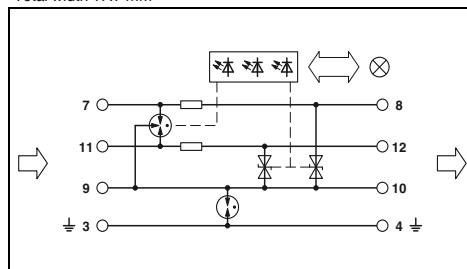

### Technical data

... 5DC	... 12DC	... 24DC	... 48DC
C1 / C2 / C3 / D1	C1 / C2 / C3 / D1	C1 / C2 / C3 / D1	C1 / C2 / C3 / D1
6 V DC / 4 V AC	15 V DC / 10 V AC	30 V DC / 21 V AC	53 V DC / 37 V AC
2.5 kA	2.5 kA	2.5 kA	2.5 kA
1000 mA (Up to 45°C)	1000 mA (Up to 45°C)	1000 mA (Up to 45°C)	300 mA (Up to 45°C)
10 kA / 10 kA	10 kA / 10 kA	10 kA / 10 kA	10 kA / 10 kA
20 kA	20 kA	20 kA	20 kA
≤ 25 V (C3 - 25 A)	≤ 35 V (C3 - 25 A)	≤ 55 V (C3 - 25 A)	≤ 90 V (C3 - 25 A)
≤ 900 V (C1 - 1 kV/500 A)	≤ 900 V (C1 - 1 kV/500 A)	≤ 900 V (C1 - 1 kV/500 A)	≤ 900 V (C1 - 1 kV/500 A)
1.2 Ω	1.2 Ω	1.2 Ω	1.2 Ω

17.7 mm / 91.1 mm / 77.5 mm  
0.2 ... 4 mm<sup>2</sup> / 0.2 ... 2.5 mm<sup>2</sup> / 24 - 12

-40 °C ... 70 °C  
IP20  
V0

EN 61643-21/A1 / IEC 61643-21/A1 / EN 61000-6-2 / EN 61000-6-2/A1 / EN 61000-6-3

Via TBUS

### Technical data

... 5DC	... 12DC	... 24DC	... 48DC
C1 / C2 / C3 / D1	C1 / C2 / C3 / D1	C1 / C2 / C3 / D1	C1 / C2 / C3 / D1
6 V DC / 4 V AC	15 V DC / 4 V AC	30 V DC / 21 V AC	53 V DC / 37 V AC
2.5 kA	2.5 kA	2.5 kA	2.5 kA
1000 mA (Up to 45°C)	1000 mA (Up to 45°C)	1000 mA (Up to 45°C)	300 mA (Up to 45°C)
- / 10 kA	- / 10 kA	- / 10 kA	- / 10 kA
20 kA	20 kA	20 kA	20 kA
≤ 25 V (C3 - 25 A)	≤ 35 V (C3 - 25 A)	≤ 55 V (C3 - 25 A)	≤ 90 V (C3 - 25 A)
1.2 Ω	1.2 Ω	1.2 Ω	1.2 Ω

17.7 mm / 91.1 mm / 77.5 mm  
0.2 ... 4 mm<sup>2</sup> / 0.2 ... 2.5 mm<sup>2</sup> / 24 - 12

-40 °C ... 70 °C  
IP20  
V0

EN 61643-21/A1 / IEC 61643-21/A1 / EN 61000-6-2 / EN 61000-6-2/A1 / EN 61000-6-3

Via TBUS

### Technical data

... 5DC	... 12DC	... 24DC	... 48DC
C1 / C2 / C3 / D1	C1 / C2 / C3 / D1	C1 / C2 / C3 / D1	C1 / C2 / C3 / D1
6 V DC / 4 V AC	15 V DC / 10 V AC	30 V DC / 21 V AC	53 V DC / 37 V AC
2.5 kA	2.5 kA	2.5 kA	2.5 kA
1000 mA (Up to 45°C)	1000 mA (Up to 45°C)	1000 mA (Up to 45°C)	300 mA (Up to 45°C)
- / 10 kA	- / 10 kA	- / 10 kA	- / 10 kA
20 kA	20 kA	20 kA	20 kA
≤ 720 V (C1 - 1 kV/500 A)	≤ 750 V (C1 - 1 kV/500 A)	≤ 800 V (C1 - 1 kV/500 A)	≤ 750 V (C1 - 1 kV/500 A)
1.2 Ω	1.2 Ω	1.2 Ω	1.2 Ω

17.7 mm / 91.1 mm / 77.5 mm  
0.2 ... 4 mm<sup>2</sup> / 0.2 ... 2.5 mm<sup>2</sup> / 24 - 12

-40 °C ... 70 °C  
IP20  
V0

EN 61643-21/A1 / IEC 61643-21/A1 / EN 61000-6-2 / EN 61000-6-2/A1 / EN 61000-6-3

Via TBUS

### Ordering data

Type	Order No.	Pcs. / Pkt.
PT-IQ-1X2+F-5DC-UT	2800792	1
PT-IQ-1X2+F-12DC-UT	2800975	1
PT-IQ-1X2+F-24DC-UT	2800977	1
PT-IQ-1X2+F-48DC-UT	2800979	1

### Accessories

Type	Order No.	Pcs. / Pkt.
PT-IQ-1X2-5DC-P	2800770	1
PT-IQ-1X2-12DC-P	2800771	1
PT-IQ-1X2-24DC-P	2800772	1
PT-IQ-1X2-48DC-P	2800773	1

### Ordering data

Type	Order No.	Pcs. / Pkt.
PT-IQ-2X1-5DC-UT	2800778	1
PT-IQ-2X1-12DC-UT	2800780	1
PT-IQ-2X1-24DC-UT	2800787	1
PT-IQ-2X1-48DC-UT	2800789	1

### Accessories

Type	Order No.	Pcs. / Pkt.
PT-IQ-2X1-5DC-P	2800774	1
PT-IQ-2X1-12DC-P	2800775	1
PT-IQ-2X1-24DC-P	2800776	1
PT-IQ-2X1-48DC-P	2800777	1

### Ordering data

Type	Order No.	Pcs. / Pkt.
PT-IQ-2X1+F-5DC-UT	2800779	1
PT-IQ-2X1+F-12DC-UT	2800781	1
PT-IQ-2X1+F-24DC-UT	2800788	1
PT-IQ-2X1+F-48DC-UT	2800790	1

### Accessories

Type	Order No.	Pcs. / Pkt.
PT-IQ-2X1-5DC-P	2800774	1
PT-IQ-2X1-12DC-P	2800775	1
PT-IQ-2X1-24DC-P	2800776	1
PT-IQ-2X1-48DC-P	2800777	1

ZB 6, see page 111

ZB 6, see page 111

ZB 6, see page 111

# Surge protection and interference filters

## Surge protection for measurement and control technology

### PLUGTRAB PT-IQ with push-in connection technology

- Surge protection system
- Multi-level state monitoring
- Collective message about supply and remote module
- Multi-level, floating remote signaling
- System supplied via DIN rail bus
- Up to 28 protection modules per supply module
- Maximum ease of maintenance thanks to the two-piece design
- Plugs are coded
- Impedance-neutral disconnection of plug for maintenance purposes
- Base element remains an integral part of the installation
- Base element in push-in connection technology

**Notes:**  
For certifications, see page 154

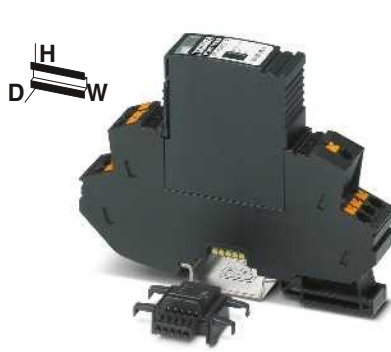

Controller for supply and remote signaling

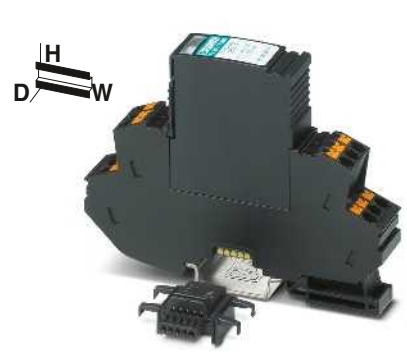

Double conductor (loop), floating, 9/10 connection grounded directly

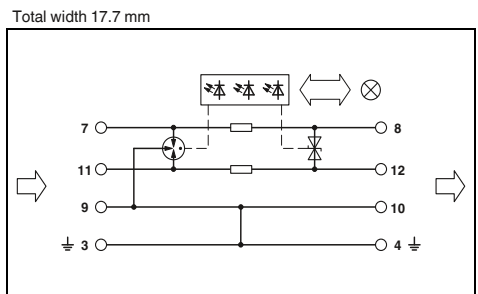
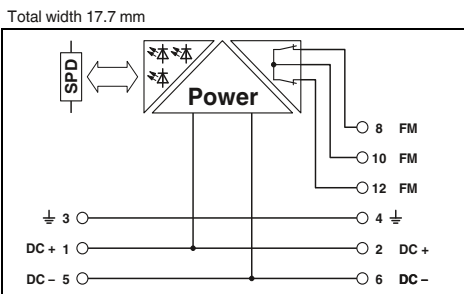

Electrical data	
IEC category / EN type	-
Maximum continuous operating voltage $U_c$	DC/AC -
Lightning test curr. $I_{imp}$ (10/350) $\mu$ s	Per path -
Nominal current $I_N$	max. 130 mA (24 V DC)
Nominal discharge surge current $I_n$ (8/20) $\mu$ s	-
Total surge current (8/20) $\mu$ s	Core-Core / Core-Ground -
Protection level $U_p$	Core-Core -
	Core-Ground -
Resistance per path	-
General data	
Dimensions W / H / D	17.7 mm / 109.3 mm / 77.5 mm
Connection data solid/stranded with ferrule/ AWG	0.2 ... 4 mm <sup>2</sup> / 0.2 ... 2.5 mm <sup>2</sup> / 24 - 12
Temperature range	-40 °C ... 70 °C
Degree of protection in acc. with IEC 60529/ EN 60529	IP20
Inflammability class in acc. with UL 94	V0
Test standards	EN 61000-6-2/A1 / EN 61000-6-3
Remote indication contact	
Connection data solid/stranded	2 x N/C contacts
Max. operating voltage	0.2 ... 4 mm <sup>2</sup> / 24 - 12
Max. operating current	35 V AC (50 - 60 Hz) / 50 V DC
	1 A (up to 50°C) / 200 mA (up to 70°C)

Technical data	
... 5DC	... 12DC
C1 / C2 / C3 / D1	C1 / C2 / C3 / D1
6 V DC / 4 V AC	15 V DC / 10 V AC
2.5 kA	2.5 kA
1000 mA (up to 40 °C)	1000 mA (up to 40 °C)
10 kA / 10 kA	10 kA / 10 kA
20 kA	20 kA
$\leq 25$ V (C3 - 25 A)	$\leq 35$ V (C3 - 25 A)
$\leq 600$ V (C1 - 1 kV/500 A)	$\leq 600$ V (C1 - 1 kV/500 A)
1.2 $\Omega$	1.2 $\Omega$

Technical data	
... 24DC	... 48DC
C1 / C2 / C3 / D1	C1 / C2 / C3 / D1
30 V DC / 21 V AC	53 V DC / 37 V AC
2.5 kA	2.5 kA
1000 mA (up to 40 °C)	300 mA (up to 70°C)
10 kA / 10 kA	10 kA / 10 kA
20 kA	20 kA
$\leq 55$ V (C3 - 25 A)	$\leq 90$ V (C3 - 25 A)
$\leq 600$ V (C1 - 1 kV/500 A)	$\leq 600$ V (C1 - 1 kV/500 A)
1.2 $\Omega$	1.2 $\Omega$

Ordering data	
Description	Voltage $U_N$
PLUGTRAB supply module, consisting of a plug, base element, and DIN rail bus	24 V DC
MCR-PLUGTRAB, consisting of a plug, base element, and DIN rail bus	5 V DC
	12 V DC
	24 V DC
	48 V DC

Ordering data	
Type	Order No.
PT-IQ-PTB-PT	2801296

Ordering data	
Type	Order No.
PT-IQ-1X2-5DC-PT	2801251
PT-IQ-1X2-12DC-PT	2801253
PT-IQ-1X2-24DC-PT	2801255
PT-IQ-1X2-48DC-PT	2801257

Accessories	
Replacement connector	
5 V DC	
12 V DC	
24 V DC	
48 V DC	

Accessories	
Type	Order No.
PT-IQ-PTB-P	2800989

Accessories	
Type	Order No.
PT-IQ-1X2-5DC-P	2800770
PT-IQ-1X2-12DC-P	2800771
PT-IQ-1X2-24DC-P	2800772
PT-IQ-1X2-48DC-P	2800773

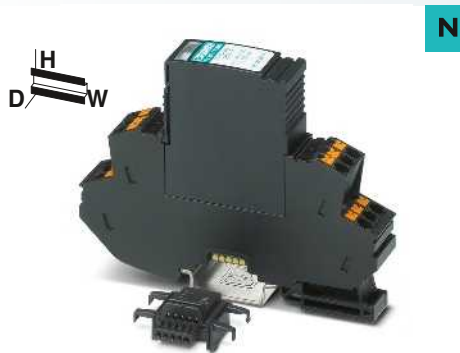

**Double conductor (loop), floating, 9/10 connection grounded via gas-filled surge arrester**

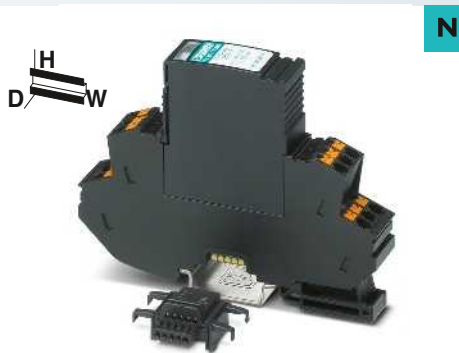

**2-wire with common reference potential, 9/10 connection grounded directly**

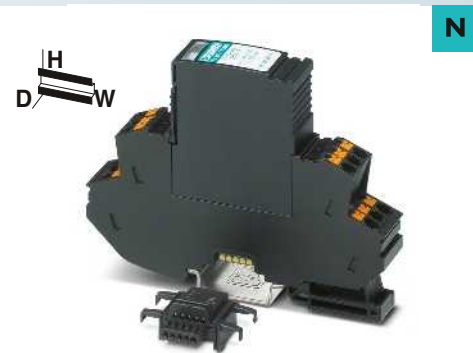

**2-wire with common reference potential, 9/10 connection grounded via gas-filled surge arrester**

Total width 17.7 mm

Total width 17.7 mm

Total width 17.7 mm

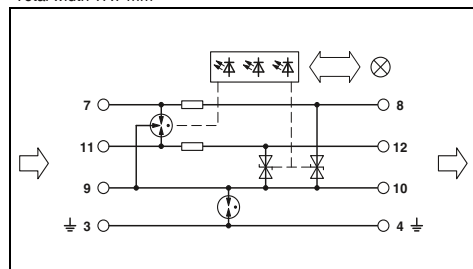
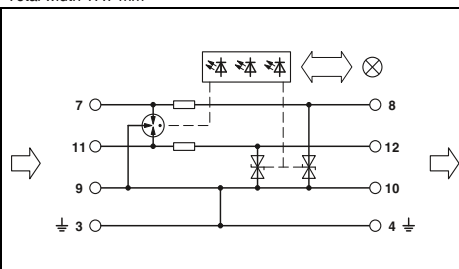
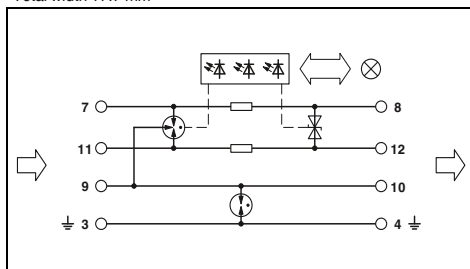

### Technical data

... 5DC	... 12DC	... 24DC	... 48DC
C1 / C2 / C3 / D1	C1 / C2 / C3 / D1	C1 / C2 / C3 / D1	C1 / C2 / C3 / D1
6 V DC / 4 V AC	15 V DC / 10 V AC	30 V DC / 21 V AC	53 V DC / 37 V AC
2.5 kA	2.5 kA	2.5 kA	2.5 kA
1000 mA (up to 40 °C)	1000 mA (up to 40 °C)	1000 mA (up to 40 °C)	300 mA (up to 70 °C)
10 kA / 10 kA	10 kA / 10 kA	10 kA / 10 kA	10 kA / 10 kA
20 kA	20 kA	20 kA	20 kA
≤ 25 V (C3 - 25 A)	≤ 35 V (C3 - 25 A)	≤ 55 V (C3 - 25 A)	≤ 90 V (C3 - 25 A)
≤ 900 V (C1 - 1 kV/500 A)	≤ 900 V (C1 - 1 kV/500 A)	≤ 900 V (C1 - 1 kV/500 A)	≤ 900 V (C1 - 1 kV/500 A)
1.2 Ω	1.2 Ω	1.2 Ω	1.2 Ω

### Technical data

... 5DC	... 12DC	... 24DC	... 48DC
C1 / C2 / C3 / D1	C1 / C2 / C3 / D1	C1 / C2 / C3 / D1	C1 / C2 / C3 / D1
6 V DC / 4 V AC	15 V DC / 4 V AC	30 V DC / 21 V AC	53 V DC / 37 V AC
2.5 kA	2.5 kA	2.5 kA	2.5 kA
1000 mA (up to 40 °C)	1000 mA (up to 40 °C)	1000 mA (up to 40 °C)	300 mA (up to 70 °C)
- / 10 kA	- / 10 kA	- / 10 kA	- / 10 kA
20 kA	20 kA	20 kA	20 kA
≤ 25 V (C3 - 25 A)	≤ 35 V (C3 - 25 A)	≤ 55 V (C3 - 25 A)	≤ 90 V (C3 - 25 A)
1.2 Ω	1.2 Ω	1.2 Ω	1.2 Ω

### Technical data

... 5DC	... 12DC	... 24DC	... 48DC
C1 / C2 / C3 / D1	C1 / C2 / C3 / D1	C1 / C2 / C3 / D1	C1 / C2 / C3 / D1
6 V DC / 4 V AC	15 V DC / 10 V AC	30 V DC / 21 V AC	53 V DC / 37 V AC
2.5 kA	2.5 kA	2.5 kA	2.5 kA
1000 mA (up to 40 °C)	1000 mA (up to 40 °C)	1000 mA (up to 40 °C)	300 mA (up to 70 °C)
- / 10 kA	- / 10 kA	- / 10 kA	- / 10 kA
20 kA	20 kA	20 kA	20 kA
≤ 720 V (C1 - 1 kV/500 A)	≤ 750 V (C1 - 1 kV/500 A)	≤ 780 V (C3 - 25 A)	≤ 750 V (C1 - 1 kV/500 A)
1.2 Ω	1.2 Ω	1.2 Ω	1.2 Ω

17.7 mm / 109.3 mm / 77.5 mm  
0.2 ... 4 mm<sup>2</sup> / 0.2 ... 2.5 mm<sup>2</sup> / 24 - 12

17.7 mm / 109.3 mm / 77.5 mm  
0.2 ... 4 mm<sup>2</sup> / 0.2 ... 2.5 mm<sup>2</sup> / 24 - 12

17.7 mm / 109.3 mm / 77.5 mm  
0.2 ... 4 mm<sup>2</sup> / 0.2 ... 2.5 mm<sup>2</sup> / 24 - 12

-40 °C ... 70 °C

IP20

V0

IEC 61643-21/A2 / EN 61643-21/A1 / EN 61000-6-2/A1 / EN 61000-6-3

Via TBUS

-40 °C ... 70 °C

IP20

V0

IEC 61643-21/A2 / EN 61643-21/A1 / EN 61000-6-2/A1 / EN 61000-6-3

Via TBUS

-40 °C ... 70 °C

IP20

V0

IEC 61643-21/A2 / EN 61643-21/A1 / EN 61000-6-2/A1 / EN 61000-6-3

Via TBUS

### Ordering data

Type	Order No.	Pcs. / Pkt.
PT-IQ-1X2+F-5DC-PT	2801252	1
PT-IQ-1X2+F-12DC-PT	2801254	1
PT-IQ-1X2+F-24DC-PT	2801256	1
PT-IQ-1X2+F-48DC-PT	2801258	1

### Ordering data

Type	Order No.	Pcs. / Pkt.
PT-IQ-2X1-5DC-PT	2801243	1
PT-IQ-2X1-12DC-PT	2801245	1
PT-IQ-2X1-24DC-PT	2801247	1
PT-IQ-2X1-48DC-PT	2801249	1

### Ordering data

Type	Order No.	Pcs. / Pkt.
PT-IQ-2X1+F-5DC-PT	2801244	1
PT-IQ-2X1+F-12DC-PT	2801246	1
PT-IQ-2X1+F-24DC-PT	2801248	1
PT-IQ-2X1+F-48DC-PT	2801250	1

### Accessories

Type	Order No.	Pcs. / Pkt.
PT-IQ-1X2-5DC-P	2800770	1
PT-IQ-1X2-12DC-P	2800771	1
PT-IQ-1X2-24DC-P	2800772	1
PT-IQ-1X2-48DC-P	2800773	1

### Accessories

Type	Order No.	Pcs. / Pkt.
PT-IQ-2X1-5DC-P	2800774	1
PT-IQ-2X1-12DC-P	2800775	1
PT-IQ-2X1-24DC-P	2800776	1
PT-IQ-2X1-48DC-P	2800777	1

### Accessories

Type	Order No.	Pcs. / Pkt.
PT-IQ-2X1-5DC-P	2800774	1
PT-IQ-2X1-12DC-P	2800775	1
PT-IQ-2X1-24DC-P	2800776	1
PT-IQ-2X1-48DC-P	2800777	1

ZB 6, see page 111

ZB 6, see page 111

ZB 6, see page 111

# Surge protection and interference filters

## Surge protection for measurement and control technology

### PLUGTRAB PT-IQ

- Surge protection system
- Multi-level state monitoring
- Collective message about supply and remote module
- Multi-level, floating remote signaling
- System supplied via DIN rail bus
- Up to 28 protection modules per supply module
- Maximum ease of maintenance thanks to the two-piece design
- Plugs are coded
- Impedance-neutral disconnection of plug for maintenance purposes
- Base element remains an integral part of the installation
- PT-IQ...-UT base element with screw connection technology
- PT-IQ...-PT base element with push-in connection technology

**Notes:**  
For certifications, see page 154

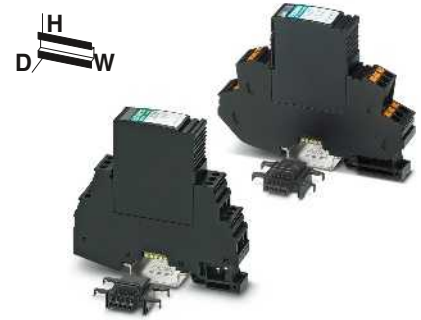

**2 double conductors (loops), floating, 9/10 connection grounded directly**

Total width 17.7 mm

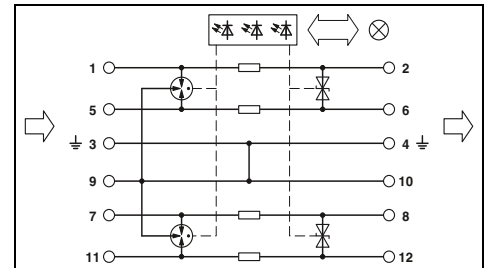

#### Technical data

Electrical data		C1 / C2 / C3 / D1
IEC category / EN type		30 V DC / 21 V AC
Maximum continuous operating voltage $U_c$	DC/AC	2.5 kA
Lightning test curr. $I_{imp}$ (10/350) $\mu$ s	Per path	700 mA (Up to 45°C)
Nominal current $I_N$		
Nominal discharge surge current $I_n$ (8/20) $\mu$ s	Core-Core / Core-Ground	10 kA / 10 kA
Total surge current (8/20) $\mu$ s		20 kA
Protection level $U_p$	Core-Core	$\leq 55$ V (C3 - 25 A)
	Core-Ground	$\leq 600$ V (C1 - 1 kV/500 A)
PT-IQ...UT dimensions W/H/D		17.7 mm / 91 mm / 77.5 mm
Resistance per path		1.2 $\Omega$
General data		
PT-IQ...PT dimensions W/H/D		17.7 mm / 109.3 mm / 77.5 mm
Connection data solid/stranded with ferrule/ AWG		0.2 ... 4 mm <sup>2</sup> / 0.2 ... 2.5 mm <sup>2</sup> / 24 - 12
Connection data, push-in solid/stranded with ferrule/AWG		0.2 ... 4 mm <sup>2</sup> / - ... - / 20 - 12
Temperature range		-40 °C ... 70 °C
Degree of protection in acc. with IEC 60529/ EN 60529		IP20
Inflammability class in acc. with UL 94		V0
Test standards		EN 61643-21/A1 / IEC 61643-21/A1 / EN 61000-6-2 / EN 61000-6-2/A1 / EN 61000-6-3
Remote indication contact		Via TBUS

#### Ordering data

Description	Voltage $U_N$	Type	Order No.	Pcs. / Pkt.
<b>MCR-PLUGTRAB</b> , consisting of a plug, base element, and DIN rail bus, with screw connection technology	24 V	<b>PT-IQ-2X2-24DC-UT</b>	2800980	1
<b>MCR-PLUGTRAB</b> , consisting of a plug, base element, and DIN rail bus, with push-in connection technology	24 V DC	<b>PT-IQ-2X2-24DC-PT</b>	2801263	1
Accessories				
<b>Replacement connector</b> 24 V DC		<b>PT-IQ-2X2-24DC-P</b>	2800804	1
<b>Marking material</b>		ZB 6, see page 111		

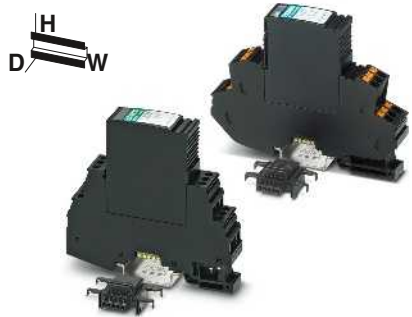

**2 double conductors (loops), floating, 9/10 connection grounded via gas-filled surge arrester**

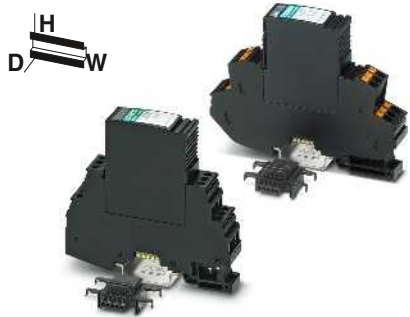

**4-wire with common reference potential, 9/10 connection grounded directly**

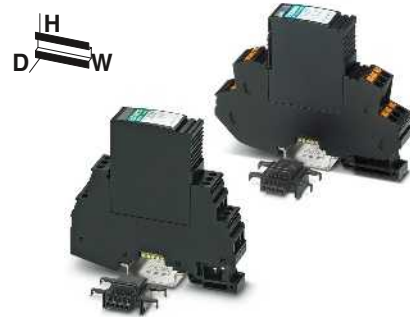

**4-wire with common reference potential, 9/10 connection grounded via gas-filled surge arrester**

Total width 17.7 mm

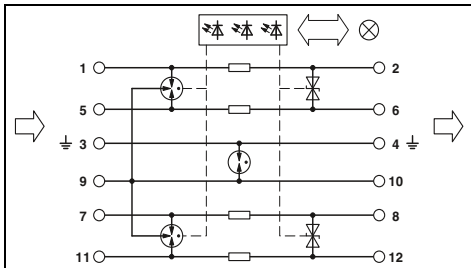

### Technical data

C1 / C2 / C3 / D1  
30 V DC / 21 V AC  
2.5 kA  
700 mA (Up to 45°C)

10 kA / 10 kA  
20 kA

≤ 55 V (C3 - 25 A)  
≤ 900 V (C1 - 1 kV/500 A)  
17.7 mm / 91 mm / 77.5 mm  
1.2 Ω

17.7 mm / 109.3 mm / 77.5 mm  
0.2 ... 4 mm<sup>2</sup> / 0.2 ... 2.5 mm<sup>2</sup> / 24 - 12

0.2 ... 4 mm<sup>2</sup> / - ... - / 20 - 12

-40 °C ... 70 °C  
IP20  
V0

EN 61643-21/A1 / IEC 61643-21/A1 / EN 61000-6-2 /  
EN 61000-6-2/A1 / EN 61000-6-3

Via TBUS

### Ordering data

Type	Order No.	Pcs. / Pkt.
PT-IQ-2X2+F-24DC-UT	2800981	1
PT-IQ-2X2+F-24DC-PT	2801264	1

### Accessories

PT-IQ-2X2-24DC-P	2800804	1
------------------	---------	---

ZB 6, see page 111

Total width 17.7 mm

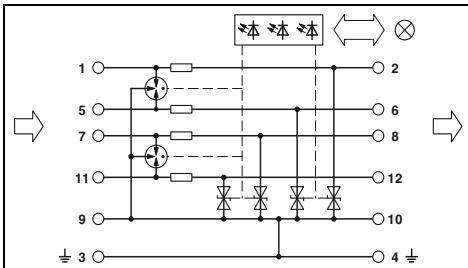

### Technical data

C1 / C2 / C3 / D1  
30 V DC / 21 V AC  
2.5 kA  
700 mA (Up to 45°C)

- / 10 kA  
20 kA

-  
≤ 60 V (C3 - 50 A)  
17.7 mm / 91.1 mm / 77.5 mm  
1.2 Ω

17.7 mm / 109.3 mm / 77.5 mm  
0.2 ... 4 mm<sup>2</sup> / 0.2 ... 2.5 mm<sup>2</sup> / 24 - 12

0.5 ... 4 mm<sup>2</sup> / 0.2 ... 2.5 mm<sup>2</sup> / 24 - 12

-40 °C ... 70 °C  
IP20  
V0

EN 61643-21/A1 / IEC 61643-21/A1 / EN 61000-6-2 /  
EN 61000-6-2/A1 / EN 61000-6-3

Via TBUS

### Ordering data

Type	Order No.	Pcs. / Pkt.
PT-IQ-4X1-24DC-UT	2800982	1
PT-IQ-4X1-24DC-PT	2801271	1

### Accessories

PT-IQ-4X1-24DC-P	2800813	1
------------------	---------	---

ZB 6, see page 111

Total width 17.7 mm

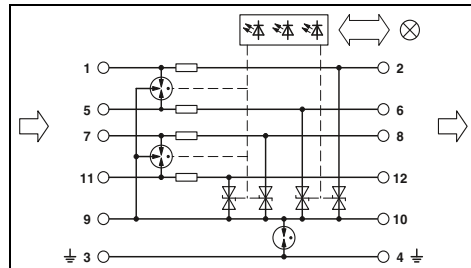

### Technical data

C1 / C2 / C3 / D1  
30 V DC / 21 V AC  
2.5 kA  
700 mA (Up to 45°C)

- / 10 kA  
20 kA

-  
≤ 780 V (C3 - 25 A)  
17.7 mm / 91.1 mm / 77.5 mm  
1.2 Ω

17.7 mm / 109.3 mm / 77.5 mm  
0.2 ... 4 mm<sup>2</sup> / 0.2 ... 2.5 mm<sup>2</sup> / 24 - 12

0.5 ... 4 mm<sup>2</sup> / 0.2 ... 2.5 mm<sup>2</sup> / 24 - 12

-40 °C ... 70 °C  
IP20  
V0

EN 61643-21/A1 / IEC 61643-21/A1 / EN 61000-6-2 /  
EN 61000-6-2/A1 / EN 61000-6-3

Via TBUS

### Ordering data

Type	Order No.	Pcs. / Pkt.
PT-IQ-4X1+F-24DC-UT	2800983	1
PT-IQ-4X1+F-24DC-PT	2801272	1

### Accessories

PT-IQ-4X1-24DC-P	2800813	1
------------------	---------	---

ZB 6, see page 111

# Surge protection and interference filters

## Surge protection for measurement and control technology

### PLUGTRAB PT-IQ with screw connection

- Surge protection system
- Multi-level state monitoring
- Collective message about supply and remote module
- Multi-level, floating remote signaling
- System supplied via DIN rail bus
- Up to 28 protection modules per supply module
- Maximum ease of maintenance thanks to the two-piece design
- Plugs are coded
- Impedance-neutral disconnection of plug for maintenance purposes
- Base element remains an integral part of the installation
- Base element with screw connection technology

**Notes:**  
 For certifications, see page 154  
 Attenuation characteristics at [www.phoenixcontact.net/products](http://www.phoenixcontact.net/products)

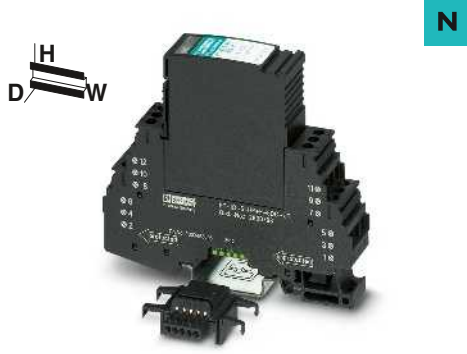

5-wire with common reference potential, 9/10 connection grounded directly

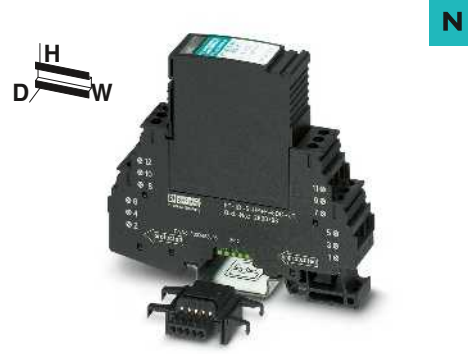

5-wire with common reference potential, 9/10 connection grounded via gas-filled surge arrester

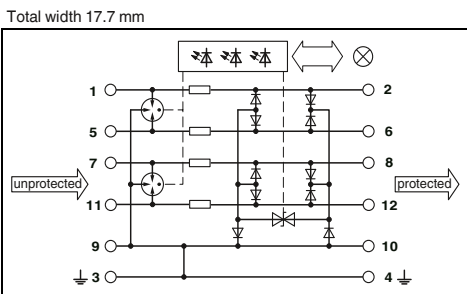

Electrical data		Technical data	
IEC category / EN type	... 5DC	... 12DC	... 5DC
Maximum continuous operating voltage $U_C$	C1 / C2 / C3 / D1	C1 / C2 / C3 / D1	C1 / C2 / C3 / D1
Lightning test curr. $I_{imp}$ (10/350) $\mu$ s	6 V DC / 4 V AC	15 V DC / 10 V AC	6 V DC / 4 V AC
Nominal current $I_N$	2.5 kA	2.5 kA	2.5 kA
Nominal discharge surge current $I_n$ (8/20) $\mu$ s	600 mA (up to 40 °C)	600 mA (up to 40 °C)	600 mA (up to 40 °C)
Total surge current (8/20) $\mu$ s	Core-Core / Core-Ground	10 kA / 10 kA	10 kA / 10 kA
Protection level $U_p$		20 kA	20 kA
Cut-off frequency $f_g$ (3 dB)	Core-Core	$\leq 30$ V (C3 - 25 A)	$\leq 40$ V (C3 - 25 A)
	Core-Ground	$\leq 30$ V (C3 - 25 A)	$\leq 40$ V (C3 - 25 A)
	Symmetrical in the 150 $\Omega$ system	> 60 MHz	> 60 MHz
Dimensions W / H / D	17.7 mm / 91 mm / 77.5 mm		
Connection data solid / stranded / AWG	0.2 ... 4 mm <sup>2</sup> / - ... - / 24 - 12		
Temperature range	-40 °C ... 70 °C		
Degree of protection in acc. with IEC 60529 / EN 60529	IP20		
Inflammability class in acc. with UL 94	V0		
Test standards	EN 61643-21/A1 / IEC 61643-21/A2 / EN 61000-6-2/A1 / EN 61000-6-3		

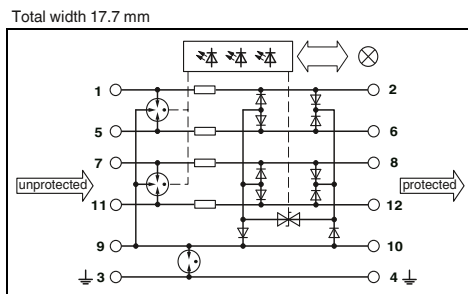

Electrical data		Technical data	
IEC category / EN type	... 5DC	... 12DC	... 5DC
Maximum continuous operating voltage $U_C$	C1 / C2 / C3 / D1	C1 / C2 / C3 / D1	C1 / C2 / C3 / D1
Lightning test curr. $I_{imp}$ (10/350) $\mu$ s	6 V DC / 4 V AC	15 V DC / 10 V AC	6 V DC / 4 V AC
Nominal current $I_N$	2.5 kA	2.5 kA	2.5 kA
Nominal discharge surge current $I_n$ (8/20) $\mu$ s	600 mA (up to 40 °C)	600 mA (up to 40 °C)	600 mA (up to 40 °C)
Total surge current (8/20) $\mu$ s	Core-Core / Core-Ground	10 kA / 10 kA	10 kA / 10 kA
Protection level $U_p$		20 kA	20 kA
Cut-off frequency $f_g$ (3 dB)	Core-Core	$\leq 30$ V (C3 - 25 A)	$\leq 40$ V (C3 - 25 A)
	Core-Ground	$\leq 30$ V (C3 - 25 A)	$\leq 900$ V (C3 - 25 A)
	Symmetrical in the 150 $\Omega$ system	> 60 MHz	> 60 MHz
Dimensions W / H / D	17.7 mm / 91 mm / 77.5 mm		
Connection data solid / stranded / AWG	0.2 ... 4 mm <sup>2</sup> / - ... - / 24 - 12		
Temperature range	-40 °C ... 70 °C		
Degree of protection in acc. with IEC 60529 / EN 60529	IP20		
Inflammability class in acc. with UL 94	V0		
Test standards	EN 61643-21/A1 / IEC 61643-21/A2 / EN 61000-6-2/A1 / EN 61000-6-3		

Description	Voltage $U_N$
<b>MCR-PLUGTRAB</b> , consisting of a plug, base element, and DIN rail bus	
Bridge between 3/4 ( $\frac{1}{2}$ ) and 9/10	5 V DC
Bridge between 3/4 ( $\frac{1}{2}$ ) and 9/10	24 V DC
Gas-filled surge arrester between 3/4 ( $\frac{1}{2}$ ) and 9/10	5 V DC
Gas-filled surge arrester between 3/4 ( $\frac{1}{2}$ ) and 9/10	24 V DC

Ordering data		
Type	Order No.	Pcs. / Pkt.
PT-IQ-5-HF-5DC-UT	2800797	1
PT-IQ-5-HF-12DC-UT	2800799	1

Ordering data		
Type	Order No.	Pcs. / Pkt.
PT-IQ-5-HF+F-5DC-UT	2800798	1
PT-IQ-5-HF+F-12DC-UT	2800801	1

Accessories		
Type	Order No.	Pcs. / Pkt.
PT-IQ-5-HF-5DC-P	2800795	1
PT-IQ-5-HF-12DC-P	2800796	1

Accessories		
Type	Order No.	Pcs. / Pkt.
PT-IQ-5-HF-5DC-P	2800795	1
PT-IQ-5-HF-12DC-P	2800796	1

Marking material  
 ZB 6, see page 111

Marking material  
 ZB 6, see page 111



**PLUGTRAB PT-IQ with push-in connection technology**

- Surge protection system
- Multi-level state monitoring
- Collective message about supply and remote module
- Multi-level, floating remote signaling
- System supplied via DIN rail bus
- Up to 28 protection modules per supply module
- Maximum ease of maintenance thanks to the two-piece design
- Plugs are coded
- Impedance-neutral disconnection of plug for maintenance purposes
- Base element remains an integral part of the installation
- Base element in push-in connection technology

**Notes:**  
 For certifications, see page 154  
 Attenuation characteristics at [www.phoenixcontact.net/products](http://www.phoenixcontact.net/products)



5-wire with common reference potential, 9/10 connection grounded directly



5-wire with common reference potential, 9/10 connection grounded via gas-filled surge arrester

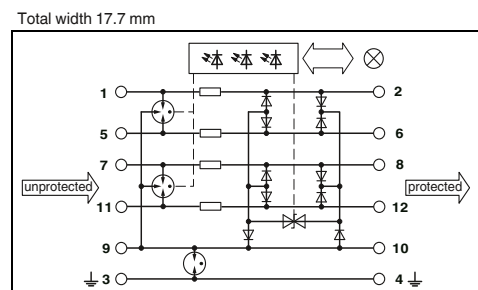
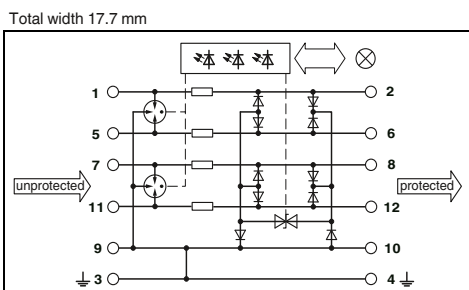

Technical data	
... 5DC	... 12DC
C1 / C2 / C3 / D1	C1 / C2 / C3 / D1
6 V DC / 4 V AC	15 V DC / 10 V AC
Per path	
2.5 kA	2.5 kA
600 mA (up to 40 °C)	600 mA (up to 40 °C)
Core-Core / Core-Ground	
10 kA / 10 kA	10 kA / 10 kA
20 kA	20 kA
Core-Core	
≤ 30 V (C3 - 25 A)	≤ 40 V (C3 - 25 A)
Core-Ground	
≤ 30 V (C3 - 25 A)	≤ 40 V (C3 - 25 A)
Cut-off frequency fg (3 dB)	
Symmetrical in the 150 Ω system	
> 60 MHz	> 60 MHz

Technical data	
... 5DC	... 12DC
C1 / C2 / C3 / D1	C1 / C2 / C3 / D1
6 V DC / 4 V AC	15 V DC / 10 V AC
Per path	
2.5 kA	2.5 kA
600 mA (up to 40 °C)	600 mA (up to 40 °C)
Core-Core / Core-Ground	
10 kA / 10 kA	10 kA / 10 kA
20 kA	20 kA
Core-Core	
≤ 30 V (C3 - 25 A)	≤ 40 V (C3 - 25 A)
Core-Ground	
≤ 900 V (C3 - 25 A)	≤ 900 V (C3 - 25 A)
Cut-off frequency fg (3 dB)	
Symmetrical in the 150 Ω system	
> 60 MHz	> 60 MHz

Electrical data	
IEC category / EN type	
Maximum continuous operating voltage $U_C$	DC/AC
Lightning test curr. $I_{imp}$ (10/350) μs	Per path
Nominal current $I_N$	
Nominal discharge surge current $I_n$ (8/20) μs	
Total surge current (8/20) μs	
Protection level $U_p$	
Cut-off frequency fg (3 dB)	
General data	
Dimensions W / H / D	
Connection data solid / stranded / AWG	
Temperature range	
Degree of protection in acc. with IEC 60529/ EN 60529	
Inflammability class in acc. with UL 94	
Test standards	

**Ordering data**

Type	Order No.	Pcs. / Pkt.
PT-IQ-5-HF-5DC-PT	2801291	1
PT-IQ-5-HF-12DC-PT	2801293	1

**Accessories**

Type	Order No.	Pcs. / Pkt.
PT-IQ-5-HF-5DC-P	2800795	1
PT-IQ-5-HF-12DC-P	2800796	1

ZB 6, see page 111

**Ordering data**

Type	Order No.	Pcs. / Pkt.
PT-IQ-5-HF+F-5DC-PT	2801292	1
PT-IQ-5-HF+F-12DC-PT	2801295	1

**Accessories**

Type	Order No.	Pcs. / Pkt.
PT-IQ-5-HF-5DC-P	2800795	1
PT-IQ-5-HF-12DC-P	2800796	1

ZB 6, see page 111

# Surge protection and interference filters

## Surge protection for measurement and control technology

### MCR-PLUGTRAB PT

**Notes:**  
For certifications, see page 154

- Seamless plug-in signal circuit protection
- Maximum ease of maintenance thanks to the two-piece design
- Base element remains an integral part of the installation
- Impedance-neutral disconnection of connector for test and maintenance purposes
- Connectors can be checked with CHECKMASTER



2 double wires (loops), floating

#### PT 2x2...

- Protection for two separate floating signal circuits
- Installed in conjunction with the PT 2x2...-BE base element

#### PT 4x1...

- Protection for four wires with common reference potential
- Installed in conjunction with the PT 4x1...-BE base element

Total width 17.7 mm

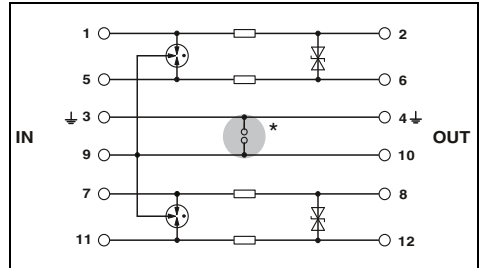

#### \* Note:

Various grounding options for the base elements:

**PT .x.-BE** connections 9/10 (GND) directly connected to the mounting foot.

**PT .x.+F-BE** connection 9/10 (GND) connected to the mounting foot via a gas-filled surge arrester.

Electrical data		... 5DC	... 12DC	... 24DC
IEC category / EN type		C1 / C2 / C3 / D1	C1 / C2 / C3 / D1	C1 / C2 / C3 / D1
Maximum continuous operating voltage $U_c$	DC/AC	6 V DC / 4 V AC	13 V DC / 9 V AC	28 V DC / 20 V AC
Lightning test curr. $I_{imp}$ (10/350) $\mu$ s	Per path	2.5 kA	2.5 kA	2.5 kA
Nominal current $I_n$		450 mA (45°C)	450 mA (45°C)	450 mA (45°C)
Nominal discharge surge current $I_n$ (8/20) $\mu$ s	Core-Core / Core-Ground	10 kA / 10 kA	10 kA / 10 kA	10 kA / 10 kA
Total surge current (8/20) $\mu$ s		20 kA	20 kA	20 kA
Output voltage limitation at 1 kV/ $\mu$ s	Core-Core / Core-Ground	$\leq 10$ V	$\leq 18$ V	$\leq 40$ V
Cut-off frequency $f_g$ (3 dB)	Symmetrical/asymmetrical in the 50 $\Omega$ system	Typ. 1 MHz / -	Typ. 3 MHz / -	Typ. 6 MHz / -
Resistance per path		2.2 $\Omega$	2.2 $\Omega$	2.2 $\Omega$
General data		17.7 mm / 90 mm / 65.5 mm		
Dimensions W / H / D		0.2 ... 4 mm <sup>2</sup> / 0.2 ... 2.5 mm <sup>2</sup> / 24 - 12		
Connection data solid / stranded / AWG		-40 °C ... 85 °C		
Temperature range		IP20		
Degree of protection in acc. with IEC 60529/ EN 60529		V0		
Inflammability class in acc. with UL 94		IEC 61643-21		
Test standards				

Technical data			
... 5DC	... 12DC	... 24DC	
C1 / C2 / C3 / D1	C1 / C2 / C3 / D1	C1 / C2 / C3 / D1	
Maximum continuous operating voltage $U_c$	DC/AC	28 V DC / 20 V AC	
Lightning test curr. $I_{imp}$ (10/350) $\mu$ s	Per path	2.5 kA	
Nominal current $I_n$		450 mA (45°C)	
Nominal discharge surge current $I_n$ (8/20) $\mu$ s	Core-Core / Core-Ground	10 kA / 10 kA	
Total surge current (8/20) $\mu$ s		20 kA	
Output voltage limitation at 1 kV/ $\mu$ s	Core-Core / Core-Ground	$\leq 18$ V	
Cut-off frequency $f_g$ (3 dB)	Symmetrical/asymmetrical in the 50 $\Omega$ system	Typ. 3 MHz / -	
Resistance per path		2.2 $\Omega$	
General data			
Dimensions W / H / D		17.7 mm / 90 mm / 65.5 mm	
Connection data solid / stranded / AWG		0.2 ... 4 mm <sup>2</sup> / 0.2 ... 2.5 mm <sup>2</sup> / 24 - 12	
Temperature range		-40 °C ... 85 °C	
Degree of protection in acc. with IEC 60529/ EN 60529		IP20	
Inflammability class in acc. with UL 94		V0	
Test standards		IEC 61643-21	

Description	Voltage $U_N$
<b>PLUGTRAB plug</b> , with protection circuit for plugging into base element PT	5 V DC 12 V DC 24 V DC 48 V DC 12 V AC 24 V AC 48 V AC
<b>PLUGTRAB base element</b> , for mounting on NS 35	
Bridge between 3/4 ( $\frac{1}{2}$ ) and 9/10	
Gas-filled surge arrester between 3/4 ( $\frac{1}{2}$ ) and 9/10	

Ordering data		
Type	Order No.	Pcs. / Pkt.
<b>PT 2X2- 5DC-ST</b>	2838241	10
<b>PT 2X2-12DC-ST</b>	2838254	10
<b>PT 2X2-24DC-ST</b>	2838228	10
<b>PT 2X2-BE</b>	2839208	10
<b>PT 2X2+F-BE</b>	2839224	10

Shield fast connection
For $\varnothing$ 3-6 mm
For $\varnothing$ 5-10 mm
Labeling material

Accessories		
SSA 3-6	2839295	10
SSA 5-10	2839512	10
ZBF ..., see page 111		



2 double wires (loops), floating



4-wire, with common reference potential



4-wire, with common reference potential

Total width 17.7 mm

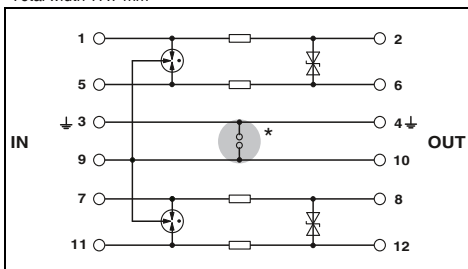

Total width 17.7 mm

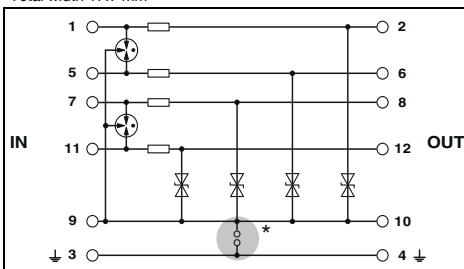

Total width 17.7 mm

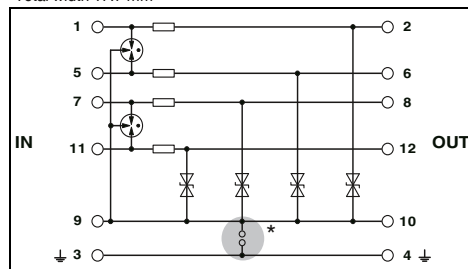

### Technical data

... 12AC	... 24AC
C1 / C2 / C3 / D1	C1 / C2 / C3 / D1
18 V DC / 13 V AC	40 V DC / 28 V AC
2.5 kA 450 mA (45°C)	2.5 kA 450 mA (45°C)
10 kA / 10 kA 20 kA	10 kA / 10 kA 20 kA
≤ 25 V -	≤ 55 V -
Typ. 4 MHz / - 2.2 Ω	Typ. 8 MHz / - 2.2 Ω

17.7 mm / 90 mm / 65.5 mm  
0.2 ... 4 mm<sup>2</sup> / 0.2 ... 2.5 mm<sup>2</sup> / 24 - 12  
-40 °C ... 85 °C  
IP20  
V0  
IEC 61643-21

### Technical data

... 5DC	... 12DC	... 24DC	... 48DC
C1 / C2 / C3 / D1	C1 / C2 / C3 / D1	C1 / C2 / C3 / D1	C1 / C2 / C3 / D1
6 V DC / 4 V AC	13 V DC / 9 V AC	28 V DC / 20 V AC	53 V DC / 37 V AC
2.5 kA 300 mA (45°C)	2.5 kA 300 mA (45°C)	2.5 kA 300 mA (45°C)	2.5 kA 300 mA (45°C)
- / 10 kA 20 kA	- / 10 kA 20 kA	- / 10 kA 20 kA	- / 10 kA 20 kA
- ≤ 10 V	- ≤ 18 V	- ≤ 40 V	- ≤ 70 V
- / Typ. 1 MHz 4.7 Ω	- / Typ. 3 MHz 4.7 Ω	- / Typ. 6 MHz 4.7 Ω	- / Typ. 9 MHz 4.7 Ω

17.7 mm / 90 mm / 65.5 mm  
0.2 ... 4 mm<sup>2</sup> / 0.2 ... 2.5 mm<sup>2</sup> / 24 - 12  
-40 °C ... 85 °C  
IP20  
V0  
IEC 61643-21

### Technical data

... 12AC	... 24AC	... 48AC
C1 / C2 / C3 / D1	C1 / C2 / C3 / D1	C1 / C2 / C3 / D1
18 V DC / 13 V AC	40 V DC / 13 V AC	77 V DC / 55 V AC
2.5 kA 300 mA (45°C)	2.5 kA 300 mA (45°C)	2.5 kA 300 mA (45°C)
- / 10 kA 20 kA	- / 10 kA 20 kA	- / 10 kA 20 kA
- ≤ 25 V	- ≤ 55 V	- ≤ 110 V (BE: 4x1)
- / Typ. 4 MHz 4.7 Ω	- / Typ. 8 MHz 4.7 Ω	- / Typ. 10 MHz 4.7 Ω

17.7 mm / 90 mm / 65.5 mm  
0.2 ... 4 mm<sup>2</sup> / 0.2 ... 2.5 mm<sup>2</sup> / 24 - 12  
-40 °C ... 85 °C  
IP20  
V0  
IEC 61643-21

### Ordering data

Type	Order No.	Pcs. / Pkt.
PT 2X2-12AC-ST	2838270	10
PT 2X2-24AC-ST	2838283	10
PT 2X2-BE	2839208	10
PT 2X2+F-BE	2839224	10

### Accessories

SSA 3-6	2839295	10
SSA 5-10	2839512	10

ZBF ..., see page 111

### Ordering data

Type	Order No.	Pcs. / Pkt.
PT 4X1-5DC-ST	2838306	10
PT 4X1-12DC-ST	2838319	10
PT 4X1-24DC-ST	2838322	10
PT 4X1-48DC-ST	2858014	10
PT 4X1-BE	2839363	10
PT 4X1+F-BE	2839376	10

### Accessories

SSA 3-6	2839295	10
SSA 5-10	2839512	10

ZBF ..., see page 111

### Ordering data

Type	Order No.	Pcs. / Pkt.
PT 4X1-12AC-ST	2838348	10
PT 4X1-24AC-ST	2838351	10
PT 4X1-48AC-ST	2804856	10
PT 4X1-BE	2839363	10
PT 4X1+F-BE	2839376	10

### Accessories

SSA 3-6	2839295	10
SSA 5-10	2839512	10

ZBF ..., see page 111

# Surge protection and interference filters

## Surge protection for measurement and control technology

### MCR-PLUGTRAB PT

**Notes:**  
For certifications, see page 154

- Seamless plug-in signal circuit protection
- Maximum ease of maintenance thanks to the two-piece design
- Base element remains an integral part of the installation
- Impedance-neutral disconnection of connector for test and maintenance purposes
- Connectors can be checked with CHECKMASTER



Double wire (loop), floating

#### PT 1x2...

- Protection for a floating signal circuit
- Installed in conjunction with the PT 1x2...-BE base element

Total width 17.7 mm

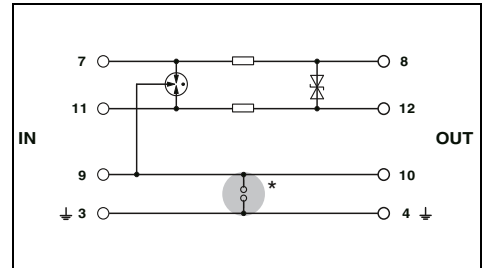

#### PT 2x1...

- Protection for two wires with common reference potential
- Installed in conjunction with the PT 2x1...-BE base element

#### \* Note:

Various grounding options for the base elements:

**PT .x.-BE** connections 9/10 (GND) directly connected to the mounting foot.

**PT .x.+F-BE** connection 9/10 (GND) connected to the mounting foot via a gas-filled surge arrester.

Electrical data		... 5DC	... 12DC	... 24DC	... 48DC
IEC category / EN type		C1 / C2 / C3 / D1	C1 / C2 / C3 / D1	C1 / C2 / C3 / D1	C1 / C2 / C3 / D1
Maximum continuous operating voltage $U_c$	DC/AC	6 V DC / 4 V AC	13 V DC / 9 V AC	28 V DC / 20 V AC	53 V DC / 37 V AC
Lightning test curr. $I_{imp}$ (10/350) $\mu$ s	Per path	2.5 kA	2.5 kA	2.5 kA	2.5 kA
Nominal current $I_n$		450 mA (45°C)	450 mA (45°C)	450 mA (45°C)	450 mA (45°C)
Nominal discharge surge current $I_n$ (8/20) $\mu$ s	Core-Core / Core-Ground	10 kA / 10 kA	10 kA / 10 kA	10 kA / 10 kA	10 kA / 10 kA
Total surge current (8/20) $\mu$ s		20 kA	20 kA	20 kA	20 kA
Output voltage limitation at 1 kV/ $\mu$ s	Core-Core / Core-Ground	$\leq$ 10 V / -	$\leq$ 18 V / -	$\leq$ 40 V / -	$\leq$ 70 V / -
Cut-off frequency fg (3 dB)	Symmetrical/asymmetrical in the 50 $\Omega$ system	Typ. 1 MHz / -	Typ. 3 MHz / -	Typ. 6 MHz / -	Typ. 10 MHz / -
Resistance per path		2.2 $\Omega$	2.2 $\Omega$	2.2 $\Omega$	2.2 $\Omega$

Technical data			
Total width 17.7 mm			
Dimensions W / H / D			
17.7 mm / 90 mm / 65.5 mm			
Connection data solid / stranded / AWG			
0.2 ... 4 mm <sup>2</sup> / 0.2 ... 2.5 mm <sup>2</sup> / 24 - 12			
Temperature range			
-40 °C ... 85 °C			
Degree of protection in acc. with IEC 60529 / EN 60529			
IP20			
Inflammability class in acc. with UL 94			
V0			
Test standards			
IEC 61643-21			

Description	Voltage $U_N$
<b>PLUGTRAB plug</b> , with protection circuit for plugging into base element PT	
	5 V DC
	12 V DC
	24 V DC
	12 V AC
	24 V AC
	48 V DC
<b>PLUGTRAB base element</b> , for mounting on NS 35	
Bridge between 3/4 ( $\frac{1}{2}$ ) and 9/10	
Gas-filled surge arrester between 3/4 ( $\frac{1}{2}$ ) and 9/10	

Ordering data		
Type	Order No.	Pcs. / Pkt.
<b>PT 1X2- 5DC-ST</b>	2856016	10
<b>PT 1X2-12DC-ST</b>	2856029	10
<b>PT 1X2-24DC-ST</b>	2856032	10
<b>PT 1X2-48DC-ST</b>	2803658	10
<b>PT 1X2-BE</b>	2856113	10
<b>PT 1X2+F-BE</b>	2856126	10

Shield fast connection	
For $\varnothing$ 3-6 mm	
For $\varnothing$ 5-10 mm	
Labeling material	

Accessories		
SSA 3-6	2839295	10
SSA 5-10	2839512	10
ZBF ..., see page 111		



Double wire (loop), floating



2-wire, with common reference potential



2-wire, with common reference potential

Total width 17.7 mm

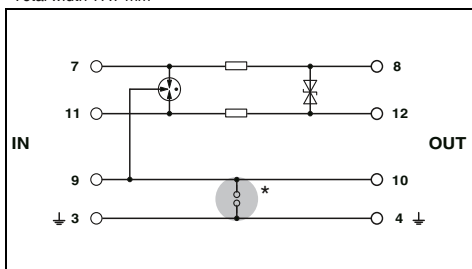

Total width 17.7 mm

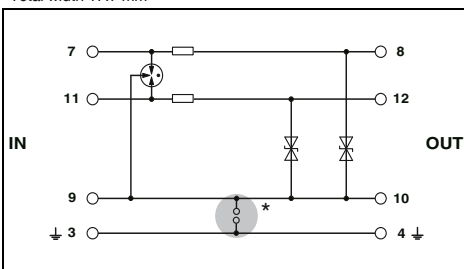

Total width 17.7 mm

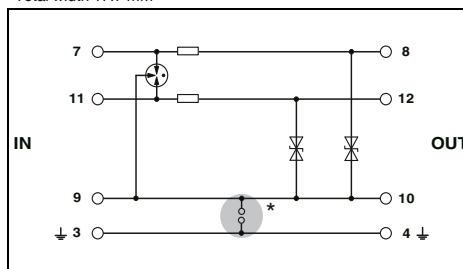

### Technical data

... 12AC	... 24AC
C1 / C2 / C3 / D1	C1 / C2 / C3 / D1
18 V DC / 13 V AC	40 V DC / 28 V AC
2.5 kA 450 mA (45°C)	2.5 kA 450 mA (45°C)
10 kA / 10 kA 20 kA	10 kA / 10 kA 20 kA
≤ 25 V -	≤ 55 V -
Typ. 4 MHz / - 2.2 Ω	Typ. 8 MHz / - 2.2 Ω

17.7 mm / 90 mm / 65.5 mm  
0.2 ... 4 mm<sup>2</sup> / 0.2 ... 2.5 mm<sup>2</sup> / 24 - 12  
-40 °C ... 85 °C  
IP20  
V0  
IEC 61643-21

### Technical data

... 5DC	... 12DC	... 24DC
C1 / C2 / C3 / D1	C1 / C2 / C3 / D1	C1 / C2 / C3 / D1
6 V DC / 4 V AC	13 V DC / 9 V AC	28 V DC / 20 V AC
2.5 kA 300 mA (45°C)	2.5 kA 300 mA (45°C)	2.5 kA 300 mA (45°C)
- / 10 kA 20 kA	- / 10 kA 20 kA	- / 10 kA 20 kA
- ≤ 10 V	- ≤ 18 V	- ≤ 40 V
- / Typ. 1 MHz 4.7 Ω	- / Typ. 3 MHz 4.7 Ω	- / Typ. 6 MHz 4.7 Ω

17.7 mm / 90 mm / 65.5 mm  
0.2 ... 4 mm<sup>2</sup> / 0.2 ... 2.5 mm<sup>2</sup> / 24 - 12  
-40 °C ... 85 °C  
IP20  
V0  
IEC 61643-21

### Technical data

... 12AC	... 24AC
C1 / C2 / C3 / D1	C1 / C2 / C3 / D1
18 V DC / 13 V AC	40 V DC / 28 V AC
2.5 kA 300 mA (45°C)	2.5 kA 300 mA (45°C)
- / 10 kA 20 kA	- / 10 kA 20 kA
- ≤ 25 V	- ≤ 55 V
- / Typ. 4 MHz 4.7 Ω	- / Typ. 8 MHz 4.7 Ω

17.7 mm / 90 mm / 65.5 mm  
0.2 ... 4 mm<sup>2</sup> / 0.2 ... 2.5 mm<sup>2</sup> / 24 - 12  
-40 °C ... 85 °C  
IP20  
V0  
IEC 61643-21

### Ordering data

Type	Order No.	Pcs. / Pkt.
PT 1X2-12AC-ST	2856045	10
PT 1X2-24AC-ST	2856058	10
PT 1X2-BE	2856113	10
PT 1X2+F-BE	2856126	10

### Accessories

SSA 3-6	2839295	10
SSA 5-10	2839512	10

ZBF ..., see page 111

### Ordering data

Type	Order No.	Pcs. / Pkt.
PT 2X1- 5DC-ST	2856061	10
PT 2X1-12DC-ST	2856074	10
PT 2X1-24DC-ST	2856087	10
PT 2X1-BE	2856139	10
PT 2X1+F-BE	2856142	10

### Accessories

SSA 3-6	2839295	10
SSA 5-10	2839512	10

ZBF ..., see page 111

### Ordering data

Type	Order No.	Pcs. / Pkt.
PT 2X1-12AC-ST	2856090	10
PT 2X1-24AC-ST	2856100	10
PT 2X1-BE	2856139	10
PT 2X1+F-BE	2856142	10

### Accessories

SSA 3-6	2839295	10
SSA 5-10	2839512	10

ZBF ..., see page 111

# Surge protection and interference filters

## Surge protection for measurement and control technology

### MCR-PLUGTRAB PT

- Seamless plug-in signal circuit protection
- Maximum ease of maintenance thanks to the two-piece design
- Base element remains an integral part of the installation
- Impedance-neutral disconnection of connector for test and maintenance purposes
- Connectors can be checked with CHECKMASTER

#### \* Note:

Various grounding options for the base elements:

**PT .x.-BE** connections 9/10 (GND) directly connected to the mounting foot.

**PT .x.+F-BE** connection 9/10 (GND) connected to the mounting foot via a gas-filled surge arrester.

**Notes:**  
For certifications, see page 154



4-wire, floating, impedance-free



Combination of double wire protection (floating) and single-phase power supply

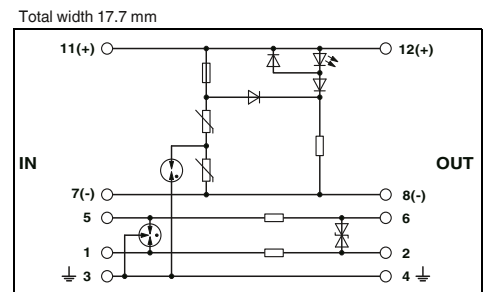
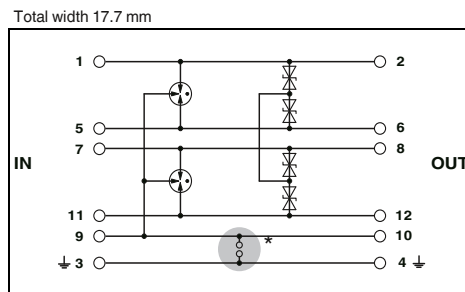

#### Technical data

Electrical data	... 5DC	... 12DC	... 24DC	... 24AC
	IEC category / EN type	C1 / C2 / C3 / D1	C1 / C2 / C3 / D1	C1 / C2 / C3 / D1
Maximum continuous operating voltage $U_c$	6 V DC / 4 V AC	12.8 V DC / 9 V AC	27 V DC / 19 V AC	40 V DC / 28 V AC
Lightning test curr. $I_{imp}$ (10/350) $\mu$ s	2.5 kA	2.5 kA	2.5 kA	2.5 kA
Nominal current $I_N$	2 A (80 °C)	2 A (80 °C)	2 A (80 °C)	2 A AC (80 °C)
Nominal discharge surge current $I_n$ (8/20) $\mu$ s	720 A / 10 kA	690 A / 10 kA	365 A / 10 kA	187 A / 10 kA
Total surge current (8/20) $\mu$ s	20 kA	20 kA	20 kA	20 kA
Max. discharge surge current $I_{max}$ (8/20) $\mu$ s	10 kA	10 kA	10 kA	10 kA
Output voltage limitation at 1 kV/ $\mu$ s				
	Core-Core	Core-Core	Core-Core	Core-Core
	≤ 10 V	≤ 18 V	≤ 40 V	≤ 75 V
	Core-Ground	Core-Ground	Core-Ground	Core-Ground
	≤ 450 V	≤ 450 V	≤ 450 V (PT 4-BE)	≤ 450 V (PT 4-BE)

#### Technical data

Mains protection	Data protection
III / T3	C1 / C2 / C3 / D1
44 V DC / 34 V AC	40 V DC / 28 V AC
-	2.5 kA
6 A (30 °C)	450 mA (45 °C)
700 A / 700 A	10 kA / 10 kA
-	20 kA
2 kA	10 kA
-	≤ 55 V
-	450 V

General data	
Dimensions W / H / D	17.7 mm / 90 mm / 65.5 mm
Connection data solid / stranded / AWG	0.2 ... 4 mm <sup>2</sup> / 0.2 ... 2.5 mm <sup>2</sup> / 24 - 12
Temperature range	-40 °C ... 85 °C
Degree of protection in acc. with IEC 60529 / EN 60529	IP20
Inflammability class in acc. with UL 94	V0
Test standards	IEC 61643-21 / DIN EN 61643-21 / UL 497B

General data	
Dimensions W / H / D	17.7 mm / 90 mm / 65.5 mm
Connection data solid / stranded / AWG	0.2 ... 4 mm <sup>2</sup> / 0.2 ... 2.5 mm <sup>2</sup> / 24 - 12
Temperature range	-40 °C ... 85 °C
Degree of protection in acc. with IEC 60529 / EN 60529	IP20
Inflammability class in acc. with UL 94	V0
Test standards	IEC 61643-1 / EN 61643-11 IEC 61643-21

#### Ordering data

Description	Voltage $U_N$	Type	Order No.	Pcs. / Pkt.
<b>PLUGTRAB plug</b> , with protection circuit for plugging into base element PT	5 V DC	PT 4- 5DC-ST	2839211	10
	12 V DC	PT 4-12DC-ST	2839237	10
	24 V DC	PT 4-24DC-ST	2839240	10
	24 V AC	PT 4-24AC-ST	2800078	1
<b>PLUGTRAB base element</b> , for mounting on NS 35	Bridge between 3/4 (±) and 9/10	PT 4-BE	2839402	10
	Gas-filled surge arrester between 3/4 (±) and 9/10	PT 4+F-BE	2839415	10
<b>PLUGTRAB base element</b> , for mounting on NS 35				

#### Ordering data

Type	Order No.	Pcs. / Pkt.
PT PE/S+1X2-24-ST	2819008	10
PT PE/S+1X2-BE	2856265	10

#### Accessories

Shield fast connection	Order No.	Pcs. / Pkt.
For Ø 3-6 mm	2839295	10
For Ø 5-10 mm	2839512	10

Labeling material ZBF ..., see page 111

#### Accessories

Shield fast connection	Order No.	Pcs. / Pkt.
SSA 3-6	2839295	10
SSA 5-10	2839512	10

ZBF ..., see page 111

### MCR-PLUGTRAB PT

- Protective devices for use in telecommu- nications and signaling networks accord- ing to IEC 61643-21
- Seamless plug-in signal circuit protection
- Maximum ease of maintenance thanks to the two-piece design
- Base element remains an integral part of the installation
- Impedance-neutral disconnection of con- nector for test and maintenance purposes
- Connectors can be checked with CHECKMASTER



2-wire, floating, free of leakage current



2-wire, with common reference potential, remote signaling

**Notes:**

For certifications, see page 154

Total width 17.7 mm

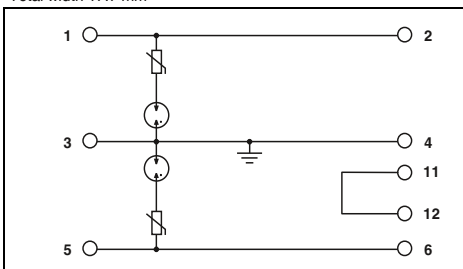

Total width 17.7 mm

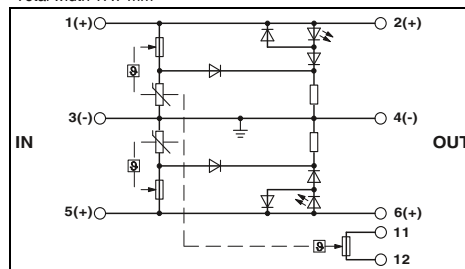

**Technical data**

Electrical data	... 120AC	... 230AC
IEC category / EN type	C1 / C2 / C3	C1 / C2 / C3 / D1
Maximum continuous operating voltage $U_C$	DC/AC -/ 175 V AC	- / 250 V AC
Lightning test curr. $I_{imp}$ (10/350) $\mu$ s	Per path 300 A	500 A
Nominal current $I_N$	6 A	6 A
Nominal discharge surge current $I_n$ (8/20) $\mu$ s	Core-Ground 3 kA	3 kA
Total surge current (8/20) $\mu$ s	8 kA	8 kA
Output voltage limitation at 1 kV/ $\mu$ s	Core-Ground $\leq$ 800 V	$\leq$ 1.4 kV
General data	EN 61643-21	
Dimensions W / H / D	17.7 mm / 90 mm / 65.5 mm	
Connection data solid / stranded / AWG	0.2 ... 4 mm <sup>2</sup> / 0.2 ... 2.5 mm <sup>2</sup> / 24 - 12	
Temperature range	-40 °C ... 80 °C	
Degree of protection in acc. with IEC 60529/ EN 60529	IP20	
Inflammability class in acc. with UL 94	V0	
Test standards	IEC 61643-1 / DIN EN 61643-21	

... 60AC	... 120AC	... 230AC
C2	C2	C2
100 V DC / 75 V AC	200 V DC / 150 V AC	350 V DC / 275 V AC
-	-	-
26 A (30 °C)	26 A (30 °C)	26 A (30 °C)
2 kA (C2 - 4 kV/2 kA)	2.5 kA (C2 - 5 kV/2.5 kA)	2.5 kA (C2 - 5 kV/2.5 kA)
4 kA	5 kA	5 kA
$\leq$ 200 V	$\leq$ 380 V	$\leq$ 650 V
General data	IEC 61643-1 / DIN EN 61643-21	
Dimensions W / H / D	17.7 mm / 90 mm / 65.5 mm	
Connection data solid / stranded / AWG	0.2 ... 4 mm <sup>2</sup> / 0.2 ... 2.5 mm <sup>2</sup> / 24 - 12	
Temperature range	-40 °C ... 85 °C	
Degree of protection in acc. with IEC 60529/ EN 60529	IP20	
Inflammability class in acc. with UL 94	V0	
Test standards	IEC 61643-1 / DIN EN 61643-21	

**Ordering data**

Description	Voltage $U_N$	Type	Order No.	Pcs. / Pkt.
<b>MAINS-PLUGTRAB</b> , consisting of a connector and a base element	120 V AC	PT 2X1-VF-120AC	2859327	10
	230 V AC	PT 2X1-VF-230AC	2805460	10
<b>PLUGTRAB plug</b> , with protection circuit for plugging into base element PT	60 V AC	PT 2X1VA- 60AC-ST	2839172	10
	120 V AC	PT 2X1VA-120AC-ST	2839185	10
	230 V AC	PT 2X1VA-230AC-ST	2839198	10
<b>PLUGTRAB base element</b> , for mounting on NS 35		PT-BE/FM	2839282	10

Type	Order No.	Pcs. / Pkt.
PT 2X1VA- 60AC-ST	2839172	10
PT 2X1VA-120AC-ST	2839185	10
PT 2X1VA-230AC-ST	2839198	10
PT-BE/FM	2839282	10

**Ordering data**

Type	Order No.	Pcs. / Pkt.
PT 2X1VA- 60AC-ST	2839172	10
PT 2X1VA-120AC-ST	2839185	10
PT 2X1VA-230AC-ST	2839198	10
PT-BE/FM	2839282	10

**Accessories**

<b>Shield fast connection</b> For $\varnothing$ 3-6 mm	SSA 3-6	2839295	10
For $\varnothing$ 5-10 mm	SSA 5-10	2839512	10
<b>Labeling material</b>	ZBF ..., see page 111		

SSA 3-6	2839295	10
SSA 5-10	2839512	10
ZBF ..., see page 111		

**Accessories**

SSA 3-6	2839295	10
SSA 5-10	2839512	10
ZBF ..., see page 111		

# Surge protection and interference filters

## Surge protection for measurement and control technology

### MCR-PLUGTRAB PT Coarse surge protection

- For systems with high dielectric strength or fine protection installed
- Installation location - directly where the MCR cable enters the building
- Seamless plug-in signal circuit protection
- Maximum ease of maintenance thanks to the two-piece design
- Base element remains an integral part of the installation
- Impedance-neutral disconnection of connector for test and maintenance purposes
- Connectors can be checked with CHECKMASTER



2-wire, coarse protection



4-wire, coarse protection

**Notes:**  
For certifications, see page 154

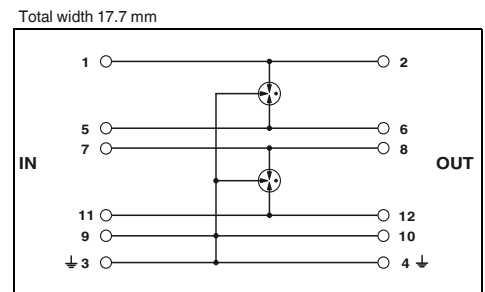
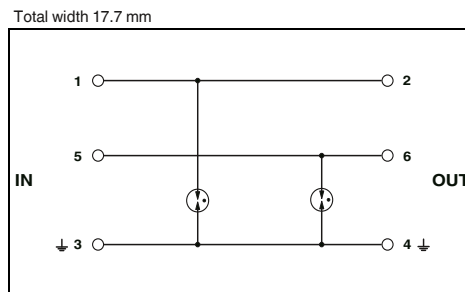

Electrical data	
IEC category / EN type	
Maximum continuous operating voltage $U_C$	DC/AC
Lightning test curr. $I_{imp}$ (10/350) $\mu s$	Per path
Nominal current $I_N$	
Nominal discharge surge current $I_n$ (8/20) $\mu s$	
	Core-Core / Core-Ground
Total surge current (8/20) $\mu s$	
Protection level $U_p$	
	Core-Ground
Output voltage limitation at 1 kV/ $\mu s$	
	Core-Ground
General data	
Dimensions W / H / D	
Connection data solid / stranded / AWG	
Temperature range	
Degree of protection in acc. with IEC 60529/ EN 60529	
Inflammability class in acc. with UL 94	
Test standards	

Technical data	
C1 / C2 / C3 / D1	
68 V DC / 48 V AC	
5 kA	
2 A (80 °C)	
	- / 20 kA
	40 kA
	$\leq 600$ V
	$\leq 600$ V
17.7 mm / 90 mm / 65.5 mm	
0.2 ... 4 mm <sup>2</sup> / 0.2 ... 2.5 mm <sup>2</sup> / 24 - 12	
-40 °C ... 85 °C	
IP20	
V0	
IEC 61643-21	

Technical data	
C1 / C2 / C3 / D1	
170 V DC / 120 V AC	
2.5 kA	
2 A (80 °C)	
	10 kA / 10 kA
	20 kA
	$\leq 450$ V
	$\leq 450$ V
17.7 mm / 90 mm / 65.5 mm	
0.2 ... 4 mm <sup>2</sup> / 0.2 ... 2.5 mm <sup>2</sup> / 24 - 12	
-40 °C ... 85 °C	
IP20	
V0	
IEC 61643-21	

Ordering data	
Description	Voltage $U_N$
<b>PLUGTRAB plug</b> , with protection circuit for plugging into base element PT	
	48 V AC
	110 V AC
<b>PLUGTRAB base element</b> , for mounting on NS 35	
Bridge between 3/4 ( $\frac{1}{2}$ ) and 9/10	

Ordering data		
Type	Order No.	Pcs. / Pkt.
PT 2-F-ST	2859000	10
PT-BE/FM	2839282	10

Ordering data		
Type	Order No.	Pcs. / Pkt.
PT 4-F-ST	2858441	10
PT 4-BE	2839402	10

Accessories	
Shield fast connection	
For $\varnothing$ 3-6 mm	
For $\varnothing$ 5-10 mm	
Labeling material	

Accessories		
	Order No.	Pcs. / Pkt.
SSA 3-6	2839295	10
SSA 5-10	2839512	10
ZBF ..., see page 111		

Accessories		
	Order No.	Pcs. / Pkt.
SSA 3-6	2839295	10
SSA 5-10	2839512	10
ZBF ..., see page 111		



**MCR-PLUGTRAB PT**

For Ex-i circuits

- Tailored to the special requirements of intrinsically safe circuits
- Seamless plug-in signal circuit protection
- Maximum ease of maintenance thanks to the two-piece design
- Base element remains an integral part of the installation
- Impedance-neutral disconnection of connector for test and maintenance purposes
- Connectors can be checked with CHECKMASTER



2 double wires (loops), intrinsically safe



4-wire, intrinsically safe, impedance-free

**Notes:**  
For certifications, see page 154

Total width 17.7 mm

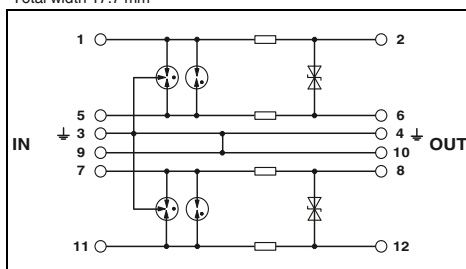

**Technical data**

<b>Electrical data</b>	
IEC category / EN type	
Maximum continuous operating voltage $U_C$	DC/AC
Lightning test curr. $I_{imp}$ (10/350) $\mu$ s	Per path
Nominal current $I_N$	
Nominal discharge surge current $I_n$ (8/20) $\mu$ s	Core-Core / Core-Ground
Total surge current (8/20) $\mu$ s	
Protection level $U_p$	Core-Core / Core-Ground
Output voltage limitation at 1 kV/ $\mu$ s	Core-Core / Core-Ground
Cut-off frequency $f_g$ (3 dB)	Core-Core / Core-Ground
Resistance per path	Symmetrical in the 50 $\Omega$ system
<b>General data</b>	
Dimensions W / H / D	
Connection data solid / stranded / AWG	
Temperature range	
Degree of protection in acc. with IEC 60529/ EN 60529	
Inflammability class in acc. with UL 94	
Test standards	
<b>Safety data</b>	
EC-type examination certificate according to ATEX	
Identification according to ATEX	
Maximum inner capacity $C_i$	
Maximum inner inductance $L_i$	
Maximum input current $I_i$	
Maximum input voltage $U_i$	
Maximum input power $P_i$	

C1 / C2 / C3 / D1	30 V DC / 21 V AC
Per path	1 kA
	325 mA (40°C)
Core-Core / Core-Ground	10 kA / 10 kA
	20 kA
Core-Core / Core-Ground	$\leq 50$ V (C3 - 25 A)
	$\leq 1$ kV (C2 - 10 kV / 5 kA)
Core-Core / Core-Ground	$\leq 45$ V / $\leq 1$ kV
Symmetrical in the 50 $\Omega$ system	Typ. 4.5 MHz
	2.2 $\Omega$
Dimensions W / H / D	
17.7 mm / 90 mm / 65.5 mm	
Connection data solid / stranded / AWG	
0.2 ... 4 mm <sup>2</sup> / 0.2 ... 2.5 mm <sup>2</sup> / 24 - 12	
Temperature range	
-40 °C ... 85 °C	
Degree of protection in acc. with IEC 60529/ EN 60529	
IP20	
Inflammability class in acc. with UL 94	
V0	
Test standards	
EN 61643-21 / EN 60079-0 / EN 60079-11 / EN 60079-26 / EN 61241-0 / EN 61241-11	
KEMA 00ATEX1099 X	
II 1G Ex ia IIC T4...T6 Ga	
II 1D Ex ia IIC T135°C...T85°C Da	
1.3 nF	
1 $\mu$ H	
325 mA (T4 / $\leq 80^\circ$ C)	
30 V DC	
3 W	

Total width 17.7 mm

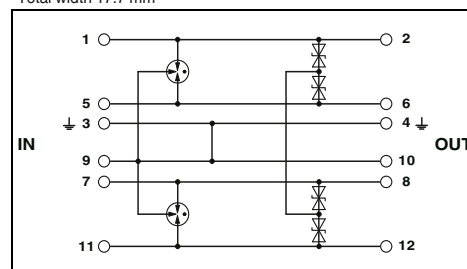

**Technical data**

<b>Electrical data</b>	
IEC category / EN type	
Maximum continuous operating voltage $U_C$	DC/AC
Lightning test curr. $I_{imp}$ (10/350) $\mu$ s	Per path
Nominal current $I_N$	
Nominal discharge surge current $I_n$ (8/20) $\mu$ s	Core-Core / Core-Ground
Total surge current (8/20) $\mu$ s	
Protection level $U_p$	Core-Core / Core-Ground
Output voltage limitation at 1 kV/ $\mu$ s	Core-Core / Core-Ground
Cut-off frequency $f_g$ (3 dB)	Core-Core / Core-Ground
Resistance per path	Symmetrical in the 50 $\Omega$ system
<b>General data</b>	
Dimensions W / H / D	
17.7 mm / 90 mm / 65.5 mm	
Connection data solid / stranded / AWG	
0.2 ... 4 mm <sup>2</sup> / 0.2 ... 2.5 mm <sup>2</sup> / 24 - 12	
Temperature range	
-40 °C ... 85 °C	
Degree of protection in acc. with IEC 60529/ EN 60529	
IP20	
Inflammability class in acc. with UL 94	
V0	
Test standards	
EN 61643-21 / EN 60079-0 / EN 60079-11 / EN 60079-26 / EN 61241-0 / EN 61241-11	
KEMA 00ATEX1099 X	
II 1G Ex ia IIC T4...T6 Ga	
II 1D Ex ia IIC T135°C...T85°C Da	
1.1 nF	
1 $\mu$ H	
500 mA (T4 / $\leq 80^\circ$ C)	
30 V DC	
850 mW (T4 / $\leq 80^\circ$ C)	

Description	Voltage $U_N$
<b>PLUGTRAB plug</b> , with protection circuit for plugging into base element PT	24 V DC
<b>PLUGTRAB base element</b> , for mounting on NS 35	

Ordering data			
Type	Order No.	Pcs. / Pkt.	
PT 2XEX(I)-24DC-ST	2838225	10	
PT 2XEX(I)-BE	2839279	10	

Ordering data			
Type	Order No.	Pcs. / Pkt.	
PT 4-EX(I)-24DC-ST	2839253	10	
PT 4-EX(I)-BE	2839486	10	

Shield fast connection	
For $\varnothing$ 3-6 mm	
For $\varnothing$ 5-10 mm	

Accessories			
SSA 3-6	2839295	10	
SSA 5-10	2839512	10	

Accessories			
SSA 3-6	2839295	10	
SSA 5-10	2839512	10	

**Labeling material**

ZBF ..., see page 111

ZBF ..., see page 111

### MCR-PLUGTRAB PT

- Protection for fieldbus systems, PROFIBUS, and signal circuits with 3 to 5-wire technology
- Cable shield connection using SSA... shield fast connection
- Grounding plug (PT MCR-EST) to short circuit and ground the potentials in PLUGTRAB-PT base elements
- Seamless plug-in signal circuit protection
- Maximum ease of maintenance thanks to the two-piece design
- Base element remains an integral part of the installation
- Impedance-neutral disconnection of connector for test and maintenance purposes
- Connectors can be checked with CHECKMASTER

**\* Note:**

Various grounding options for the base elements:

**PT .x.-BE** connections 9/10 (GND) directly connected to the mounting foot.

**PT .x.+F-BE** connection 9/10 (GND) connected to the mounting foot via a gas-filled surge arrester.

<b>Notes:</b>
For certifications, see page 154
Attenuation characteristics at <a href="http://www.phoenixcontact.net/products">www.phoenixcontact.net/products</a>



5-wire, with common reference potential

Total width 17.7 mm

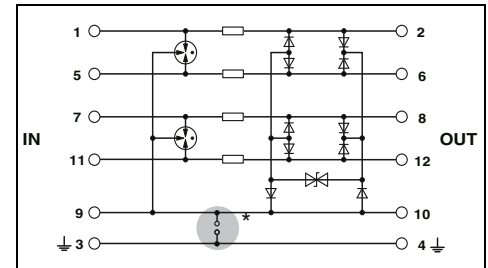

**Technical data**

Electrical data	... 5DC	... 12DC
IEC category / EN type	C1 / C2 / C3 / D1	C1 / C2 / C3 / D1
Maximum continuous operating voltage $U_c$	DC/AC 5.2 V DC / 3.6 V AC	14 V DC / 9.8 V AC
Lightning test curr. $I_{imp}$ (10/350) $\mu$ s	Per path 2.5 kA	2.5 kA
Nominal current $I_n$	450 mA (45°C)	450 mA (45°C)
Nominal discharge surge current $I_n$ (8/20) $\mu$ s	Core-Core / Core-Ground 10 kA / 10 kA	10 kA / 10 kA
Total surge current (8/20) $\mu$ s	20 kA	20 kA
Output voltage limitation at 1 kV/ $\mu$ s	Core-Core $\leq 15$ V	$\leq 25$ V
	Core-Ground $\leq 15$ V	$\leq 25$ V
Cut-off frequency fg (3 dB)	Symmetrical in the 100 $\Omega$ system	Typ. 70 MHz
Resistance per path		Typ. 70 MHz
General data		2.2 $\Omega$
Dimensions W / H / D		17.7 mm / 90 mm / 65.5 mm
Connection data solid / stranded / AWG		0.2 ... 4 mm <sup>2</sup> / 0.2 ... 2.5 mm <sup>2</sup> / 24 - 12
Temperature range		-40 °C ... 85 °C
Degree of protection in acc. with IEC 60529/ EN 60529		IP20
Inflammability class in acc. with UL 94		V0
Test standards		IEC 61643-21/A1 / EN 61643-21/A1

**Ordering data**

Description	Voltage $U_N$	Type	Order No.	Pcs. / Pkt.
<b>PLUGTRAB plug</b> , with protection circuit for plugging into base element PT				
	5 V DC	<b>PT 5-HF- 5 DC-ST</b>	<b>2838762</b>	10
Protection for 2 signal conductors	12 V DC	<b>PT 5-HF-12 DC-ST</b>	<b>2838775</b>	10
	24 V DC			
<b>Grounding plug</b> , for MCR-PLUGTRAB base elements				
<b>PLUGTRAB base element</b> , for mounting on NS 35				
Bridge between 3/4 ( $\pm$ ) and 9/10		<b>PT 2X2-BE</b>	<b>2839208</b>	10
Gas-filled surge arrester between 3/4 ( $\pm$ ) and 9/10		<b>PT 2X2+F-BE</b>	<b>2839224</b>	10

**Accessories**

Shield fast connection	SSA 3-6	2839295	10
For $\varnothing$ 3-6 mm			
For $\varnothing$ 5-10 mm	<b>SSA 5-10</b>	<b>2839512</b>	10
<b>Labeling material</b>	ZBF ..., see page 111		



2 x 2 conductor, floating



3-wire, PROFIBUS (up to 12 MHz)



Grounding plug for MCR-PLUGTRAB

Total width 17.7 mm

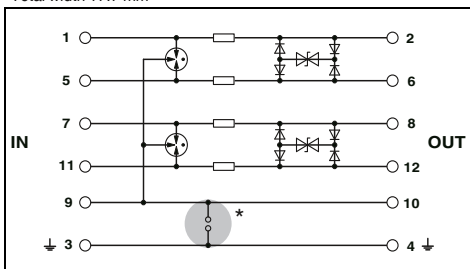

Total width 17.7 mm

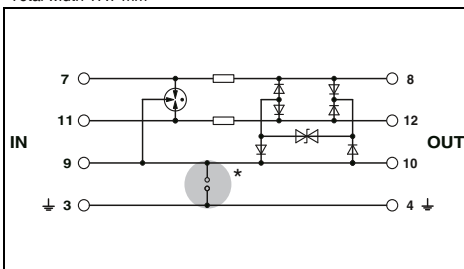

Total width 17.7 mm

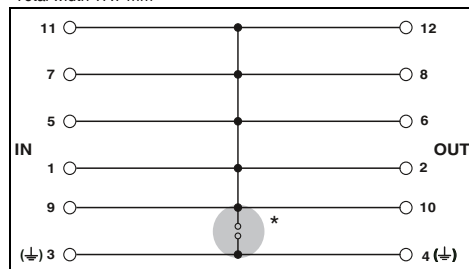

### Technical data

... 5DC	... 12DC	... 24DC
C1 / C2 / C3 / D1	C1 / C2 / C3 / D1	C1 / C2 / C3 / D1
5.2 V DC / 3.6 V AC	13 V DC / 9 V AC	28 V DC / 19.8 V AC
2.5 kA	2.5 kA	2.5 kA
450 mA (45°C)	450 mA (45°C)	450 mA (45°C)
10 kA / 10 kA	10 kA / 10 kA	10 kA / 10 kA
20 kA	20 kA	20 kA
≤ 15 V	≤ 25 V	≤ 45 V
-	-	-
Typ. 70 MHz	Typ. 70 MHz	Typ. 70 MHz
2.2 Ω	2.2 Ω	2.2 Ω

17.7 mm / 45 mm / 52 mm  
 0.2 ... 4 mm<sup>2</sup> / 0.2 ... 2.5 mm<sup>2</sup> / 24 - 12  
 -40 °C ... 85 °C  
 IP20  
 V0  
 IEC 61643-21

### Technical data

... 3-PB	... 3-HF
C1 / C2 / C3 / D1	C1 / C2 / C3 / D1
5.2 V DC / 3.6 V AC	14 V DC / 9.8 V AC
2.5 kA	2.5 kA
450 mA (45°C)	450 mA (45°C)
10 kA / 10 kA	10 kA / 10 kA
20 kA	20 kA
≤ 15 V	≤ 25 V
≤ 15 V	≤ 25 V
Typ. 70 MHz	Typ. 70 MHz
2.2 Ω	2.2 Ω

17.7 mm / 90 mm / 65.5 mm  
 0.2 ... 4 mm<sup>2</sup> / 0.2 ... 2.5 mm<sup>2</sup> / 24 - 12  
 -40 °C ... 85 °C  
 IP20  
 V0  
 IEC 61643-21/A1 / EN 61643-21/A1

### Technical data

-
-
2 A (at 40 °C)
-
-
-
-
-
-

17.7 mm / 90 mm / 65.5 mm  
 -  
 -40 °C ... 85 °C  
 IP20  
 V0  
 -

### Ordering data

Type	Order No.	Pcs. / Pkt.
PT 2X2-HF- 5 DC-ST	2839567	10
PT 2X2-HF-12 DC-ST	2839570	10
PT 2X2-HF-24 DC-ST	2839729	10
PT 2X2-BE	2839208	10
PT 2X2+F-BE	2839224	10

### Accessories

SSA 3-6	2839295	10
SSA 5-10	2839512	10

ZBF ..., see page 111

### Ordering data

Type	Order No.	Pcs. / Pkt.
PT 3-PB-ST	2858030	10
PT 3-HF-12DC-ST	2858043	10
PT 1X2-BE	2856113	10
PT 1X2+F-BE	2856126	10

### Accessories

SSA 3-6	2839295	10
SSA 5-10	2839512	10

ZBF ..., see page 111

### Ordering data

Type	Order No.	Pcs. / Pkt.
PT MCR-EST	2880749	10

### Accessories

--	--	--

ZBF ..., see page 111

# Surge protection and interference filters

## Surge protection for measurement and control technology

### LINETRAB LIT

- Protection of up to four signal wires with a design width of 6.2 mm
- Can be used in binary, analog, and intrinsically safe circuits

The latest information on approvals and use in intrinsically safe circuits can be found at [www.phoenixcontact.net/products](http://www.phoenixcontact.net/products).

<b>Notes:</b>
For certifications, see page 154
For additional safety data, visit <a href="http://www.phoenixcontact.com">www.phoenixcontact.com</a>

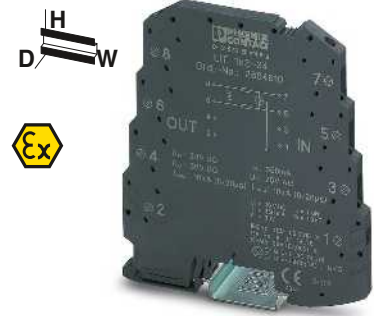

Double wire (loop), floating

Total width 6.2 mm

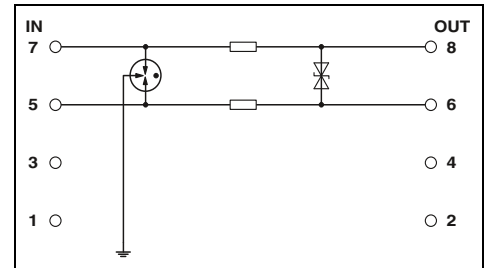

#### Technical data

<b>Electrical data</b>			C1 / C2 / C3 / D1
IEC category / EN type			36 V DC / 25 V AC
Maximum continuous operating voltage $U_c$	DC/AC		500 A
Lightning test curr. $I_{imp}$ (10/350) $\mu$ s	Per path		350 mA (40°C)
Nominal current $I_N$			
Nominal discharge surge current $I_n$ (8/20) $\mu$ s	Core-Core / Core-Ground	5 kA / 5 kA	
Total surge current (8/20) $\mu$ s		20 kA	
Protection level $U_p$	Core-Core / Core-Ground	$\leq 50$ V (C3 - 10 A) / $\leq 650$ V (C1 - 500 V / 250 A)	
Cut-off frequency $f_g$ (3 dB)	Symmetrical in the 50 $\Omega$ system	Typ. 6 MHz	
Resistance per path		3.3 $\Omega$	
<b>General data</b>			
Dimensions W / H / D		6.2 mm / 93 mm / 102.5 mm	
Connection data solid / stranded / AWG		0.14 ... 2.5 mm <sup>2</sup> / 0.2 ... 2.5 mm <sup>2</sup> / 26 - 12	
Temperature range		-40 °C ... 80 °C	
Degree of protection in acc. with IEC 60529/ EN 60529		IP20	
Inflammability class in acc. with UL 94		V0	
Test standards		IEC 61643-21 / DIN EN 61643-21 / EN 60079-0 / EN 60079-11 / EN 60079-26 / EN 61241-0	
<b>Safety data</b>			
EC-type examination certificate according to ATEX		KEMA 09ATEX0051 X	
Identification according to ATEX		Ex II 1 G Ex ia IIC T4...T6 Ex II 1 D Ex iaD 20 T85°C...135°C	
Maximum inner capacity $C_i$		1.3 nF	
Maximum inner inductance $L_i$		< 1 $\mu$ H	
Maximum input current $I_i$		350 mA (T4 / $\leq 80$ °C)	
Maximum input voltage $U_i$		36 V DC	
Maximum input power $P_i$		3 W	

#### Ordering data

Description	Voltage $U_N$	Type	Order No.	Pcs. / Pkt.
LINETRAB	24 V DC	LIT 1X2-24	2804610	10

#### Accessories

System adapter, for MINI Analog modules with screw connection	MINI MCR-SL-V8-FLK 16-A	2811268	1
VARIOFACE system cable for connecting LIT and MINI Analog via system adapter	VIP-CAB-FLK16/FR/FR/0,14/2,0M	2900156	1
Cable length: 2 m	VIP-CAB-FLK16/FR/FR/0,14/1,0M	2900155	1
Cable length: 1 m	VIP-CAB-FLK16/FR/FR/0,14/0,5M	2900154	1
Cable length: 0.5 m			
UniCard sheets, for marker groove	UC-TM 6 (see page 111)		

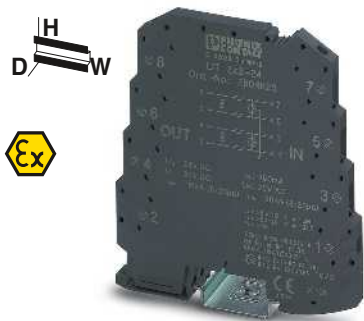

2 double wires (loops), floating



2-wire, with common reference potential



4-wire, with common reference potential

Total width 6.2 mm

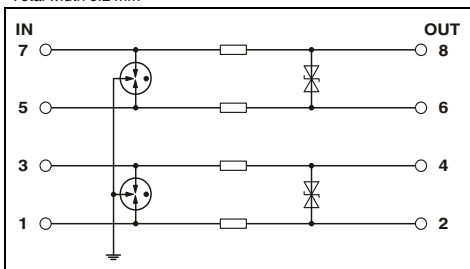

### Technical data

C1 / C2 / C3 / D1  
36 V DC / 25 V AC  
500 A  
350 mA (40°C)

5 kA / 5 kA  
20 kA

≤ 50 V (C3 - 10 A) / ≤ 650 V (C1 - 500 V / 250 A)

Typ. 6 MHz  
3.3 Ω

6.2 mm / 93 mm / 102.5 mm  
0.14 ... 2.5 mm<sup>2</sup> / 0.2 ... 2.5 mm<sup>2</sup> / 26 - 12  
-40 °C ... 80 °C  
IP20  
V0  
IEC 61643-21 / DIN EN 61643-21 / EN 60079-0 /  
EN 60079-11 / EN 60079-26 / EN 61241-0

KEMA 09ATEX0051 X  
Ex II 1 G Ex ia IIC T4...T6  
Ex II 1 D Ex iaD 20 T85°C...135°C  
1.3 nF  
< 1 μH  
350 mA (T4 / ≤ 80°C)  
36 V DC  
3 W

### Ordering data

Type	Order No.	Pcs. / Pkt.
LIT 2X2-24	2804623	10

### Accessories

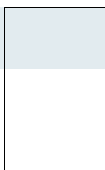

UC-TM 6 (see page 111)

Total width 6.2 mm

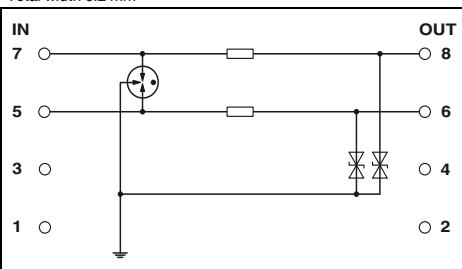

### Technical data

C1 / C2 / C3 / D1  
36 V DC / 25 V AC  
500 A  
350 mA (40°C)

- / 5 kA  
20 kA

- / ≤ 60 V (C1 - 500 V / 250 A)

-  
3.3 Ω

6.2 mm / 93 mm / 102.5 mm  
0.14 ... 2.5 mm<sup>2</sup> / 0.2 ... 2.5 mm<sup>2</sup> / 26 - 12  
-40 °C ... 80 °C  
IP20  
V0  
IEC 61643-21 / DIN EN 61643-21  
-

-  
-  
-  
-  
-  
-  
-

### Ordering data

Type	Order No.	Pcs. / Pkt.
LIT 2X1-24	2804636	10

### Accessories

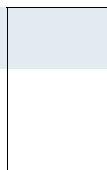

UC-TM 6 (see page 111)

Total width 6.2 mm

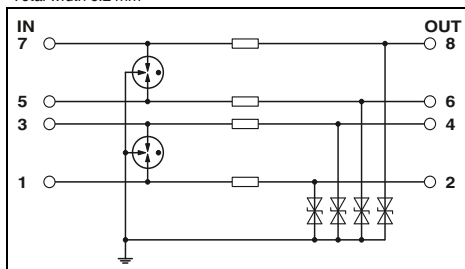

### Technical data

C1 / C2 / C3 / D1  
36 V DC / 25 V AC  
500 A  
350 mA (40°C)

- / 5 kA  
20 kA

- / ≤ 60 V (C1 - 500 V / 250 A)

-  
3.3 Ω

6.2 mm / 93 mm / 102.5 mm  
0.14 ... 2.5 mm<sup>2</sup> / 0.2 ... 2.5 mm<sup>2</sup> / 26 - 12  
-40 °C ... 80 °C  
IP20  
V0  
IEC 61643-21 / DIN EN 61643-21  
-

-  
-  
-  
-  
-  
-  
-

### Ordering data

Type	Order No.	Pcs. / Pkt.
LIT 4X1-24	2804649	10

### Accessories

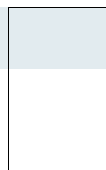

UC-TM 6 (see page 111)

# Surge protection and interference filters

## Surge protection for measurement and control technology

### LINETRAB LIT

- Protection for up to four signal wires
- Cross-arrester bridging of the reference potential with ME 6,2 TBUS
- Protection of up to four signal wires with a design width of 6.2 mm
- Complete normal mode voltage protection between all wires

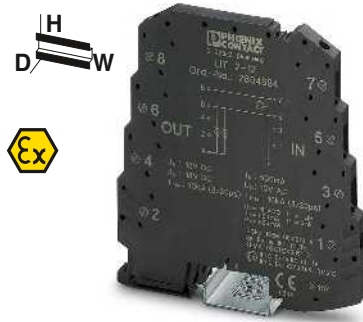

2-wire, floating, impedance-free

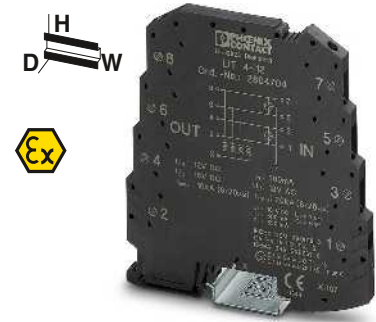

4-wire, floating, impedance-free

<b>Notes:</b>
For certifications, see page 154
For additional safety data, visit <a href="http://www.phoenixcontact.com">www.phoenixcontact.com</a>

Total width 6.2 mm

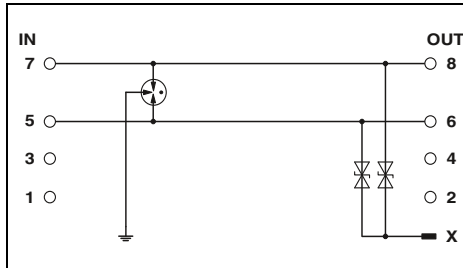

#### Technical data

Electrical data	... 12	... 24
IEC category / EN type	C1 / C2 / C3 / D1	C1 / C2 / C3 / D1
Maximum continuous operating voltage $U_C$	18 V DC / 13 V AC	36 V DC / 25 V AC
Lightning test curr. $I_{imp}$ (10/350) $\mu$ s	500 A	500 A
Nominal current $I_N$	500 mA (40°C)	500 mA (40°C)
Nominal discharge surge current $I_n$ (8/20) $\mu$ s	350 A / 5 kA	250 A / 5 kA
	20 kA	20 kA
Total surge current (8/20) $\mu$ s	350 A / 5 kA	250 A / 5 kA
Protection level $U_p$	20 kA	20 kA
	Core-Core / Core-Ground	Core-Core / Core-Ground
	$\leq 50$ V (C3 - 10 A)	$\leq 60$ V (C3 - 10 A)
	$\leq 650$ V (C2 - 10 kV / 5 kA)	$\leq 650$ V (C2 - 10 kV / 5 kA)
Cut-off frequency $f_g$ (3 dB)	Asymmetrical in the 50 $\Omega$ system	Asymmetrical in the 50 $\Omega$ system
	Typ. 5 MHz	Typ. 7.5 MHz
Resistance per path	0 $\Omega$	0 $\Omega$
General data		
Dimensions W / H / D	6.2 mm / 93 mm / 102.5 mm	6.2 mm / 93 mm / 102.5 mm
Connection data solid / stranded / AWG	0.14 ... 2.5 mm <sup>2</sup> / 0.2 ... 2.5 mm <sup>2</sup> / 26 - 12	0.14 ... 2.5 mm <sup>2</sup> / 0.2 ... 2.5 mm <sup>2</sup> / 26 - 12
Temperature range	-40 °C ... 80 °C	-40 °C ... 80 °C
Degree of protection in acc. with IEC 60529/ EN 60529	IP20	IP20
Inflammability class in acc. with UL 94	V0	V0
Test standards	IEC 61643-21 / DIN EN 61643-21 / EN 60079-0 /	IEC 61643-21 / DIN EN 61643-21 / EN 60079-0 /
Safety data		
EC-type examination certificate according to ATEX	KEMA 09ATEX0051 X	KEMA 09ATEX0051 X
Identification according to ATEX	$\text{Ex}$ II 1 G Ex ia IIC T4...T6 $\text{Ex}$ II 1 D Ex ia D 20 T85°C...135°C	$\text{Ex}$ II 1 G Ex ia IIC T4...T6 $\text{Ex}$ II 1 D Ex ia D 20 T85°C...135°C
Maximum inner capacity $C_i$	3 nF	6 nF
Maximum inner inductance $L_i$	< 1 $\mu$ H	< 1 $\mu$ H
Maximum input current $I_i$	500 mA (T4 / -40...+80°C)	500 mA (T4 / -40...+80°C)
Maximum input voltage $U_i$	18 V DC	18 V DC
Maximum input power $P_i$	635 mW	635 mW

Total width 6.2 mm

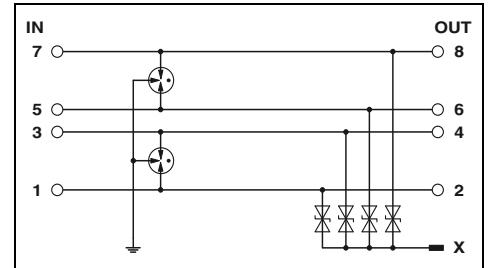

#### Technical data

Electrical data	... 12	... 24
IEC category / EN type	C1 / C2 / C3 / D1	C1 / C2 / C3 / D1
Maximum continuous operating voltage $U_C$	18 V DC / 13 V AC	36 V DC / 25 V AC
Lightning test curr. $I_{imp}$ (10/350) $\mu$ s	500 A	500 A
Nominal current $I_N$	500 mA (40°C)	500 mA (40°C)
Nominal discharge surge current $I_n$ (8/20) $\mu$ s	350 A / 5 kA	250 A / 5 kA
	20 kA	20 kA
Total surge current (8/20) $\mu$ s	350 A / 5 kA	250 A / 5 kA
Protection level $U_p$	20 kA	20 kA
	Core-Core / Core-Ground	Core-Core / Core-Ground
	$\leq 50$ V (C3 - 10 A)	$\leq 60$ V (C3 - 10 A)
	$\leq 650$ V (C2 - 10 kV / 5 kA)	$\leq 650$ V (C2 - 10 kV / 5 kA)
Cut-off frequency $f_g$ (3 dB)	Asymmetrical in the 50 $\Omega$ system	Asymmetrical in the 50 $\Omega$ system
	Typ. 5 MHz	Typ. 7.5 MHz
Resistance per path	0 $\Omega$	0 $\Omega$
General data		
Dimensions W / H / D	6.2 mm / 93 mm / 102.5 mm	6.2 mm / 93 mm / 102.5 mm
Connection data solid / stranded / AWG	0.14 ... 2.5 mm <sup>2</sup> / 0.2 ... 2.5 mm <sup>2</sup> / 26 - 12	0.14 ... 2.5 mm <sup>2</sup> / 0.2 ... 2.5 mm <sup>2</sup> / 26 - 12
Temperature range	-40 °C ... 80 °C	-40 °C ... 80 °C
Degree of protection in acc. with IEC 60529/ EN 60529	IP20	IP20
Inflammability class in acc. with UL 94	V0	V0
Test standards	IEC 61643-21 / DIN EN 61643-21 / EN 60079-0 /	IEC 61643-21 / DIN EN 61643-21 / EN 60079-0 /
Safety data		
EC-type examination certificate according to ATEX	KEMA 09ATEX0051 X	KEMA 09ATEX0051 X
Identification according to ATEX	$\text{Ex}$ II 1 G Ex ia IIC T4...T6 $\text{Ex}$ II 1 D Ex ia D 20 T85°C...135°C	$\text{Ex}$ II 1 G Ex ia IIC T4...T6 $\text{Ex}$ II 1 D Ex ia D 20 T85°C...135°C
Maximum inner capacity $C_i$	6 nF	2.5 nF
Maximum inner inductance $L_i$	< 1 $\mu$ H	< 1 $\mu$ H
Maximum input current $I_i$	500 mA (T4 / -40...+80°C)	500 mA (T4 / -40...+80°C)
Maximum input voltage $U_i$	18 V DC	36 V DC
Maximum input power $P_i$	550 mW	550 mW

#### Ordering data

Description	Voltage $U_N$
LINETRAB, with integrated surge protection, for mounting on NS 35	12 V DC
	24 V DC

Type	Order No.	Pcs. / Pkt.
LIT 2-12	2804694	10
LIT 2-24	2804665	10

#### Ordering data

Description	Voltage $U_N$
LINETRAB, with integrated surge protection, for mounting on NS 35	12 V DC
	24 V DC

Type	Order No.	Pcs. / Pkt.
LIT 4-12	2804704	10
LIT 4-24	2804678	10

#### Accessories

System adapter, for MINI Analog modules with screw connection		
DIN rail connector		
UniCard sheets, for marker groove		

MINI MCR-SL-V8-FLK 16-A	2811268	1
ME 6,2 TBUS-2 1,5/5-ST-3,81KMGY	2969401	10
UC-TM 6 (see page 111)		

#### Accessories

MINI MCR-SL-V8-FLK 16-A	2811268	1
ME 6,2 TBUS-2 1,5/5-ST-3,81KMGY	2969401	10
UC-TM 6 (see page 111)		

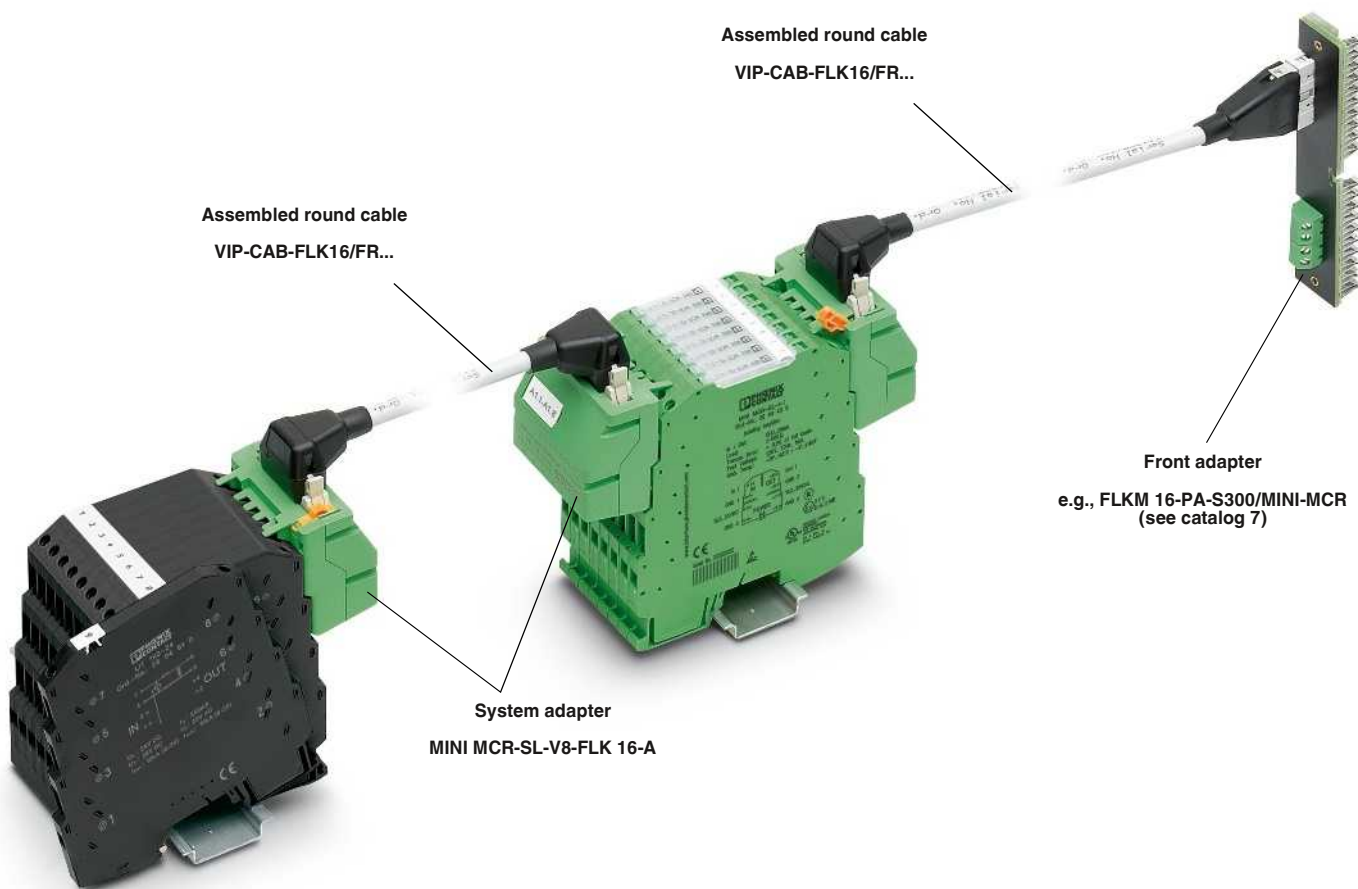

**Configuration aid for LINETRAB - MINI Analog**

Since LINETRAB and MINI Analog housing is the same shape, the advantages of system cabling can be utilized. You can create a perfectly coordinated, protected signal string from the sensor through to the controller. The table below lists possible combinations with the system adapter (8 modules each). The complete configuration aid is available in the Download Center under LINETRAB. More detailed information about MINI Analog can be found in the catalog 7.

TRABTECH - LINETRAB	
Order No.	Type
2804610	LIT 1X2-24

INTERFACE - MINI Analog	
Order No.	Type
2864383	MINI MCR-SL-UI-UI
2864150	MINI MCR-SL-UI-UI-NC
2865007	MINI MCR-SL-U-UI-NC
2813512	MINI MCR-SL-U-I-0
2813525	MINI MCR-SL-U-I-4
2813541	MINI MCR-SL-I-U-0
2813538	MINI MCR-SL-I-U-4
2864406	MINI MCR-SL-I-I
2864684	MINI MCR-SL-U-U
2864794	MINI MCR-SL-UI-2I
2864176	MINI MCR-SL-UI-2I-NC
2864419	MINI MCR-SL-1CP-I-I
2864082	MINI MCR-SL-UI-F
2864105	MINI MCR-SL-NAM-2RNO
2864480	MINI MCR-SL-UI-REL
2810780	MINI MCR-SL-SHUNT-UI-NC
2810858	MINI MCR-SL-SHUNT-UI

# Surge protection and interference filters

## Surge protection for measurement and control technology

### Modular terminal blocks with multiple stage surge protection **TERMITRAB**

- Multi-stage modular terminal blocks with screw connection method
- Versions with and without disconnect knife
- Disconnection of signal circuits by disconnect knife

#### TT-2-PE-...

- Protection of a floating double wire
- E.g., 0 - 20 mA or 0 - 10 V signals

#### TT-2-PE/S1...

- Protection of a floating double wire in which the introduction of additional resistors for decoupling the protection stages leads to problems
- E.g., for two-wire temperature measurement, PT 100

#### TT-2/2...

- Protection of two signal wires with common reference potential
- E.g., binary signals of position encoders

#### TT-EX(I)-...

- Protection of a floating double wire in intrinsically safe circuits
- Use in Ex protection zones 1 and 2
- Wires can be led through to Ex protection zone 0
- To terminate a row of TERMITRAB TT... devices, covers are available in the corresponding colors
- Other voltage levels available on request

**Notes:**  
For certifications, see page 154

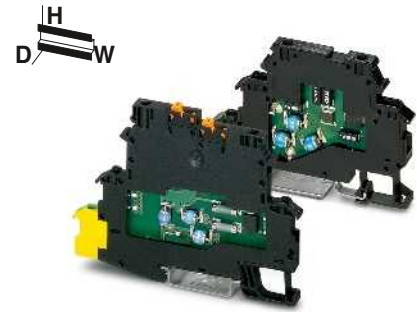

Double wire (loop), floating

Total width 6.2 mm

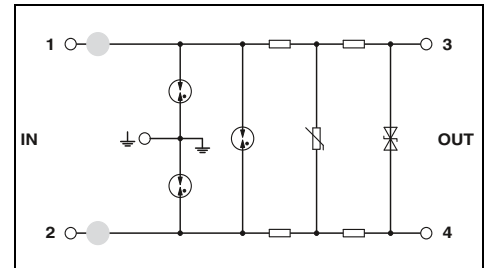

#### Technical data

	... M-24DC			... 24DC			... 110AC		
	C1 / C2 / C3 / D1	C1 / C2 / C3 / D1	C1 / C2 / C3 / D1	C1 / C2 / C3 / D1	C1 / C2 / C3 / D1	C1 / C2 / C3 / D1	C1 / C2 / C3 / D1	C1 / C2 / C3 / D1	C1 / C2 / C3 / D1
IEC category / EN type	DC/AC								
Maximum continuous operating voltage $U_c$	30 V DC / 21 V AC			30 V DC / -			- / 120 V AC		
Lightning test curr. $I_{imp}$ (10/350) $\mu$ s	500 A			500 A			500 A		
Nominal load current $I_n$	300 mA (40°C)			300 mA (40°C)			300 mA (30 °C)		
Nominal discharge surge current $I_n$ (8/20) $\mu$ s	Core-Core / Core-Ground			5 kA / 5 kA			5 kA / 5 kA		
Total surge current (8/20) $\mu$ s	10 kA			10 kA			10 kA		
Output voltage limitation at 1 kV/ $\mu$ s	Core-Core / Core-Ground			$\leq 45$ V / $\leq 650$ V			$\leq 45$ V / $\leq 650$ V		
Core-Core / Core-Ground	$\leq 45$ V / $\leq 650$ V			$\leq 45$ V / $\leq 650$ V			$\leq 250$ V / $\leq 650$ V		
Cut-off frequency $f_g$ (3 dB)	Symmetrical/asymmetrical in the 50 $\Omega$ system			Typ. 6 MHz / - 3.3 $\Omega$			Typ. 3.2 MHz / - 3.7 $\Omega$		
Resistance per path				Typ. 15 MHz / - 9.4 $\Omega$					
<b>General data</b>									
Dimensions W/H/D (with disconnect knife)				6.2 mm / 92 mm / 66.45 mm					
Dimensions W/H/D (without disconnect knife)				6.2 mm / 79.6 mm / 54.6 mm					
Connection data solid / stranded / AWG				0.2 ... 2.5 mm <sup>2</sup> / 0.2 ... 2.5 mm <sup>2</sup> / 24 - 14					
Temperature range				-40 °C ... 80 °C					
Degree of protection in acc. with IEC 60529/ EN 60529				IP20					
Inflammability class in acc. with UL 94				V2					
Test standards				-					
<b>Safety data</b>									
EC-type examination certificate according to ATEX	-			-			-		
Identification according to ATEX	-			-			-		
Approvals according to IECEx	-			-			-		
Maximum inner capacity $C_i$	-			-			-		
Maximum inner inductance $L_i$	-			-			-		
Maximum input current $I_i$	-			-			-		
Maximum input voltage $U_i$	-			-			-		
Maximum input power $P_i$	-			-			-		

#### Ordering data

Description	Voltage $U_N$	Type	Order No.	Pcs. / Pkt.
<b>TERMITRAB</b> , modular terminal block with integrated surge protection, for mounting on NS 35				
With disconnect knife	24 V DC	TT-2-PE-M-24DC	2920641	14
Without disconnect knife	24 V DC	TT-2-PE- 24DC	2838186	10
Without disconnect knife	110 V AC	TT-2-PE-110AC	2858483	10

#### Accessories

<b>Cover</b> , for terminating a row of terminal blocks				
For terminal blocks with disconnect knife		TT-D-2-PE-M-BK	2920654	50
For terminal blocks without disconnect knife		D-DEK 1,5 BK	2838995	50

**Labeling material**  
ZB 6, see page 111





Double wire (loop), floating



2-wire, with common reference potential

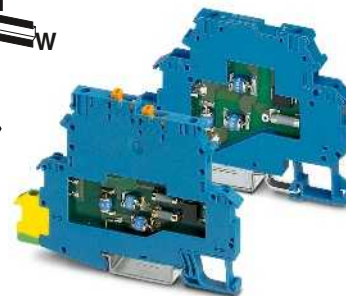

Double wire (loop), intrinsically safe

Total width 6.2 mm

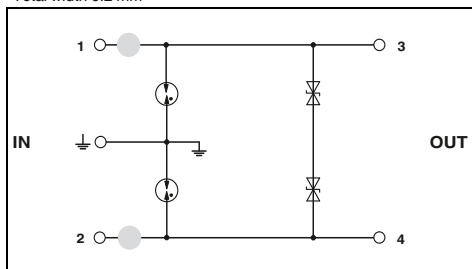

### Technical data

... M-24DC	... 24DC
C1 / C2 / C3 / D1	C1 / C2 / C3 / D1
30 V DC / 21 V AC	30 V DC / 21 V AC
500 A	500 A
10 A (40°C)	10 A (40°C)
300 A / 5 kA	300 A / 5 kA
10 kA	10 kA
≤ 45 V / ≤ 650 V	≤ 45 V / ≤ 700 V
Typ. 7 MHz / -	Typ. 6 MHz / -
-	-

6.2 mm / 92 mm / 66.45 mm  
 6.2 mm / 79.6 mm / 54.6 mm  
 0.2 ... 2.5 mm<sup>2</sup> / 0.2 ... 2.5 mm<sup>2</sup> / 24 - 14  
 -40 °C ... 80 °C  
 IP20  
 V2  
 DIN EN 61643-21

Total width 6.2 mm

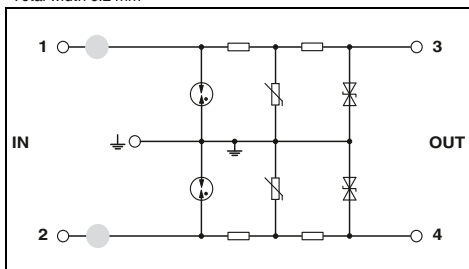

### Technical data

... M-24DC	... 24DC
C1 / C2 / C3 / D1	C1 / C2 / C3 / D1
30 V DC / 21 V AC	30 V DC / -
500 A	500 A
300 mA (40°C)	300 mA (40°C)
5 kA / 5 kA	- / 5 kA
10 kA	10 kA
- / ≤ 45 V	- / ≤ 50 V
- / Typ. 6 MHz	- / Typ. 1.5 MHz
4.7 Ω	6.6 Ω

6.2 mm / 92 mm / 66.45 mm  
 6.2 mm / 79.6 mm / 54.6 mm  
 0.2 ... 2.5 mm<sup>2</sup> / 0.2 ... 2.5 mm<sup>2</sup> / 24 - 14  
 -40 °C ... 80 °C  
 IP20  
 V2  
 IEC 61643-21

Total width 6.2 mm

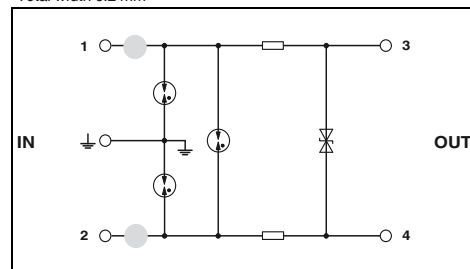

### Technical data

... M-24DC	... 24DC
C1 / C2 / C3 / D1	C1 / C2 / C3 / D1
30 V DC / 21 V AC	30 V DC / -
500 A	500 A
250 mA (T <sub>A</sub> < 40 °C)	250 mA (40°C)
5 kA / 5 kA	5 kA / 5 kA
10 kA	10 kA
≤ 44 V / ≤ 1.5 kV	≤ 50 V / ≤ 1.7 kV
Typ. 6 MHz / -	Typ. 6 MHz / -
4.7 Ω	4.7 Ω

6.2 mm / 92 mm / 66.45 mm  
 6.2 mm / 79.6 mm / 54.6 mm  
 0.2 ... 2.5 mm<sup>2</sup> / 0.2 ... 2.5 mm<sup>2</sup> / 24 - 14  
 -40 °C ... 80 °C  
 IP20  
 V2  
 IEC 61643-21 / EN 60079-0 / EN 60079-11 /

KEMA 99ATEX5687 X	KEMA 99ATEX5687 X
Ex II 1G Ex ia IIC T4...T6 Ga	Ex II 1G Ex ia IIC T4...T6 Ga
Ex II 1D Ex ia II CT135°C...T85°C Da	Ex II 1D Ex ia II CT135°C...T85°C Da
Ex ia IIC T4...T6 Ga	Ex ia IIC T4...T6 Ga
Ex ia IIIC T135°C...T85°C Da	Ex ia IIIC T135°C...T85°C Da
2 nF	2 nF
1 μH	1 μH
250 mA	250 mA (T <sub>A</sub> < 40 °C)
30 V	30 V
0.75 W	0.75 W

### Ordering data

Type	Order No.	Pcs. / Pkt.
TT-2-PE/S1-M-24DC	2920638	14
TT-2-PE/S1- 24DC	2839538	10

### Accessories

TT-D-2-PE-M-BK	2920654	50
D-DEK 1,5 BK	2838995	50

### Ordering data

Type	Order No.	Pcs. / Pkt.
TT-2/2-M-24DC	2920722	14
TT-2/2- 24DC	2838173	10

### Accessories

TT-D-2-PE-M-BK	2920654	50
D-DEK 1,5 BK	2838995	50

### Ordering data

Type	Order No.	Pcs. / Pkt.
TT-EX(I)-M-24DC	2803865	14
TT-EX(I)- 24DC	2832124	10

### Accessories

TT-D-2-PE-M-BU	2803878	50
D-DEK 1,5 BU	2838982	50

ZB 6, see page 111

ZB 6, see page 111

ZB 6, see page 111

# Surge protection and interference filters

## Surge protection for measurement and control technology

### Modular terminal blocks with multiple stage surge protection **TERMITRAB**

- Multi-stage modular terminal blocks with spring-cage connection
- Versions with and without disconnect knife
- Disconnection of signal circuits by disconnect knife

#### TT-ST-M-EX(I)-24D

- Can be used in Ex protection zones 1 and 2
- Wires can be led through to Ex protection zone 0

**Notes:**  
For certifications, see page 154

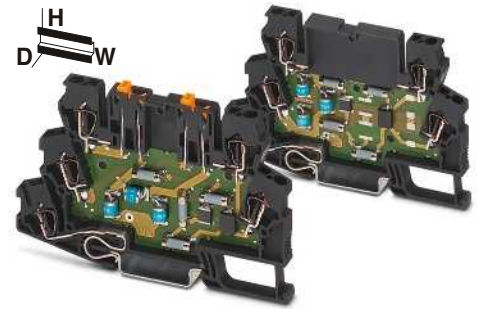

Double wire (loop), floating

Total width 6.2 mm

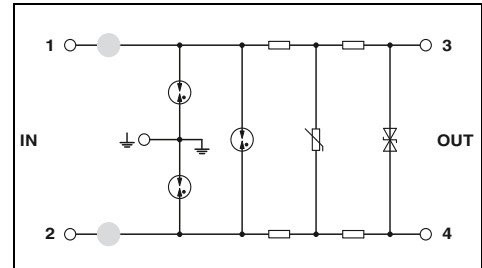

#### Technical data

	... M...24AC	... M...24DC	... 24DC
	C1 / C2 / C3 / D1	C1 / C2 / C3 / D1	C1 / C2 / C3 / D1
Maximum continuous operating voltage $U_c$	DC/AC 45 V DC / 31 V AC	30 V DC / 21 V AC	30 V DC / 21 V AC
Lightning test curr. $I_{imp}$ (10/350) $\mu$ s	Per path 1 kA	1 kA	1 kA
Nominal load current $I_n$	350 mA (45°C)	350 mA (45°C)	350 mA (45°C)
Nominal discharge surge current $I_n$ (8/20) $\mu$ s	Core-Core / Core-Ground 5 kA / 5 kA 10 kA	5 kA / 5 kA 10 kA	5 kA / 5 kA 10 kA
Total surge current (8/20) $\mu$ s			
Output voltage limitation at 1 kV/ $\mu$ s	Core-Core / Core-Ground $\leq 55$ V / $\leq 600$ V	$\leq 40$ V / $\leq 600$ V	$\leq 40$ V / $\leq 600$ V
Cut-off frequency $f_g$ (3 dB)	Symmetrical/asymmetrical in the 50 $\Omega$ system 3.5 MHz / - 6.6 $\Omega$	Typ. 3 MHz / - 6.6 $\Omega$	3 MHz / - 6.6 $\Omega$
Resistance per path	6.6 $\Omega$	6.6 $\Omega$	6.6 $\Omega$
Capacity per path	2 pF	2 pF	2 pF
<b>General data</b>			
Dimensions W/H/D (with disconnect knife)	6.2 mm / 100 mm / 63.5 mm		
Dimensions W/H/D (without disconnect knife)	6.2 mm / 100 mm / 63.5 mm		
Connection data solid / stranded / AWG	0.2 ... 4 mm <sup>2</sup> / 0.2 ... 2.5 mm <sup>2</sup> / 24 - 12		
Temperature range	-40 °C ... 85 °C		
Degree of protection in acc. with IEC 60529/ EN 60529	IP20		
Inflammability class in acc. with UL 94	V2		
Test standards	IEC 61643-21/A1 / EN 61643-21/A1		
<b>Safety data</b>			
EC-type examination certificate according to ATEX	-	-	-
Identification according to ATEX	-	-	-
Approvals according to IECEx	-	-	-
Maximum inner capacity $C_i$	-	-	-
Maximum inner inductance $L_i$	-	-	-
Maximum input current $I_i$	-	-	-
Maximum input voltage $U_i$	-	-	-
Maximum input power $P_i$	-	-	-

#### Ordering data

Description	Voltage $U_N$	Type	Order No.	Pcs. / Pkt.
<b>TERMITRAB</b> , spring-cage modular terminal block with integrated surge protection disconnect knives, for mounting on NS 35				
With disconnect knife	24 V AC	<b>TT-ST-M-2-PE-24AC</b>	<b>2858920</b>	10
With disconnect knife	24 V DC	<b>TT-ST-M-2-PE-24DC</b>	<b>2858904</b>	10
Without disconnect knife	24 V DC	<b>TT-ST-2-PE-24DC</b>	<b>2858878</b>	10

#### Accessories

<b>Cover</b> , for terminating a row of terminal blocks	<b>TT-D-STTCO-BK</b>	2858894	50
<b>Labeling material</b>	ZB 6, see page 111		

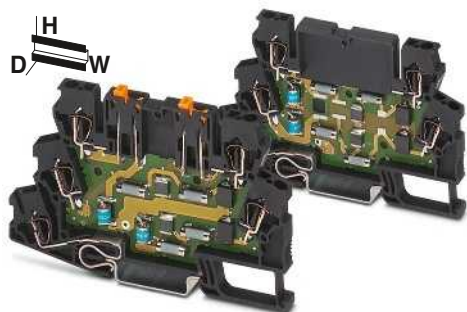

2-wire, with common reference potential

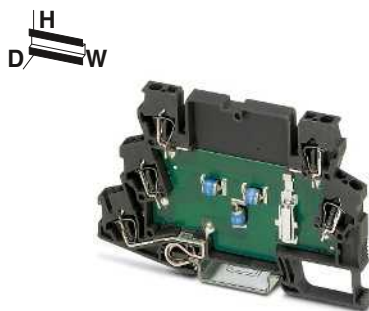

Double wire (loop), floating

N

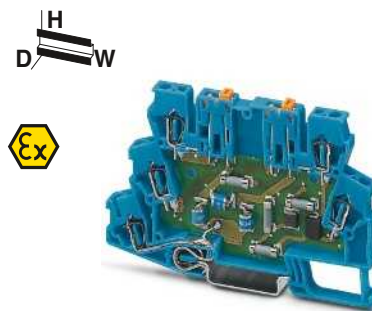

Double wire (loop), intrinsically safe

Total width 6.2 mm

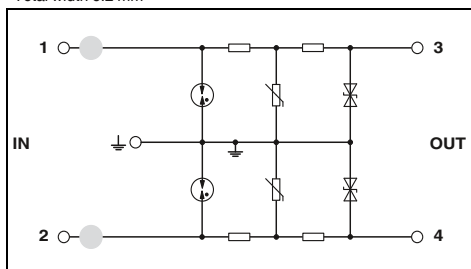

### Technical data

... M...24AC	... M...24DC	... 24DC
C1 / C2 / C3 / D1	C1 / C2 / C3 / D1	C1 / C2 / C3 / D1
45 V DC / 31 V AC	30 V DC / 21 V AC	30 V DC / 21 V AC
1 kA	1 kA	1 kA
300 mA (45°C)	300 mA (45°C)	300 mA (45°C)

- / 5 kA	- / 5 kA	- / 5 kA
10 kA	10 kA	10 kA

- / ≤ 55 V	- / ≤ 40 V	- / ≤ 40 V
------------	------------	------------

- / Typ. 3.5 MHz	- / Typ. 3 MHz	- / Typ. 3 MHz
9.4 Ω	9.4 Ω	9.4 Ω
2 nF	2 nF	2 nF

6.2 mm / 100 mm / 63.5 mm
6.2 mm / 100 mm / 63.5 mm
0.2 ... 4 mm <sup>2</sup> / 0.2 ... 2.5 mm <sup>2</sup> / 24 - 12
-40 °C ... 85 °C

IP20
V2
IEC 61643-21/A1 / EN 61643-21/A1

-
-
-
-
-
-
-
-
-
-

### Ordering data

Type	Order No.	Pcs. / Pkt.
TT-ST-M-2/2-24AC	2858933	10
TT-ST-M-2/2-24DC	2858917	10
TT-ST-2/2-24DC	2858881	10

### Accessories

TT-D-STTCO-BK	2858894	50
---------------	---------	----

ZB 6, see page 111

Total width 6.2 mm

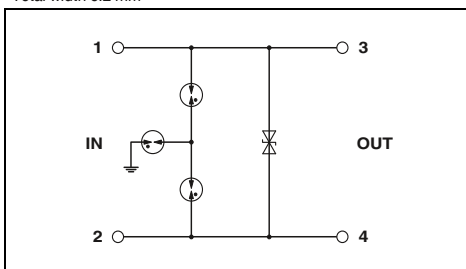

### Technical data

C1 / C2 / C3 / D1
30 V DC / 21 V AC

500 A
6 A (40°C)

300 A / 5 kA
5 kA

≤ 45 V / ≤ 800 V
------------------

Typ. 3.3 MHz / -
-
-

-
6.2 mm / 100 mm / 63.5 mm
0.2 ... 4 mm <sup>2</sup> / 0.2 ... 2.5 mm <sup>2</sup> / 24 - 12
-40 °C ... 80 °C

IP20
V0
IEC 61643-21/A1 / EN 61643-21/A1

-
-
-
-
-
-
-
-
-
-

### Ordering data

Type	Order No.	Pcs. / Pkt.
TT-ST-2-PE/S2-24DC	2801458	10

### Accessories

TT-D-STTCO-BK	2858894	50
---------------	---------	----

ZB 6, see page 111

Total width 6.2 mm

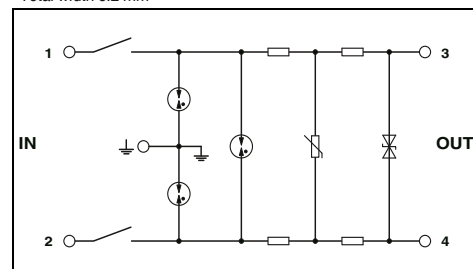

### Technical data

C1 / C2 / C3 / D1
-------------------

30 V DC / -
-------------

1 kA
200 mA (T <sub>A</sub> < 40 °C)

5 kA / 5 kA
10 kA

≤ 40 V / ≤ 1.5 kV
-------------------

Typ. 3 MHz / -
6.6 Ω
-

6.2 mm / 100 mm / 63.5 mm
-
0.5 ... 4 mm <sup>2</sup> / 0.5 ... 2.5 mm <sup>2</sup> / 24 - 12
-40 °C ... 80 °C

IP20
V2
DIN EN 61643-21 / EN 60079-0 / EN 60079-11 /

KEMA 04ATEX1059 X
Ex II 1G Ex ia IIC T4...T6 Ga
Ex II 1D Ex ia IIC T135°C...T85°C Da
Ex ia IIC T4...T6 Ga
Ex ia IIC T135°C...T85°C Da
4 nF
1 μH
200 mA (T <sub>A</sub> ≤ 85°C)
30 V
1.6 W

### Ordering data

Type	Order No.	Pcs. / Pkt.
TT-ST-M-EX(I)-24DC	2859424	10

### Accessories

TT-D-ST-BU	2856773	10
------------	---------	----

ZB 6, see page 111

# Surge protection and interference filters

## Surge protection for measurement and control technology

### TERMITRAB modular terminal block with single-level surge protection

- Modular terminal blocks with screw connection method
- Can be used as fine protection/medium protection in the signal circuits of electronic controllers

**Notes:**  
For certifications, see page 154

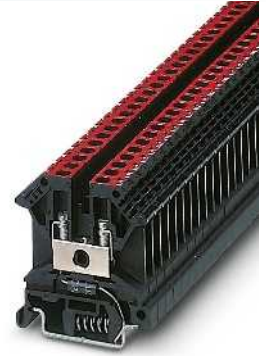

With suppressor diode, direction of action: core-ground

Total width 6.2 mm

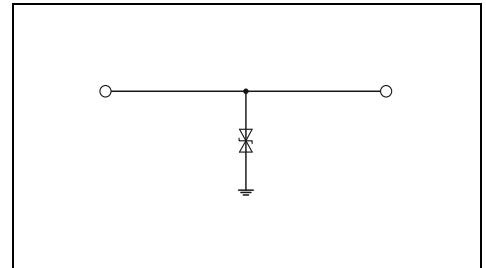

Electrical data	
IEC category / EN type	DC/AC
Maximum continuous operating voltage $U_c$	DC/AC
Nominal current $I_N$	
Nominal discharge surge current $I_n$ (8/20) $\mu$ s	Core-Core / Core-Ground
Total surge current (8/20) $\mu$ s	Core-Core / Core-Ground
Output voltage limitation at 1 kV/ $\mu$ s	Core-Core / Core-Ground
General data	
Dimensions W / H / D	
Connection data solid / stranded / AWG	
Temperature range	
Degree of protection in acc. with IEC 60529/ EN 60529	
Inflammability class in acc. with UL 94	
Test standards	

Technical data		
... 12DC	... 24DC	... 48DC
C1 / C3	C3	C3
13 V DC / 9 V AC	28 V DC / 20 V AC	53 V DC / 37 V AC
32 A (50°C)	32 A (50°C)	32 A (50°C)
- / 346 A	- / 169 A	- / 90 A
346 A	169 A	90 A
- / $\leq$ 19 V	- / $\leq$ 40 V	- / $\leq$ 80 V
6.2 mm / 42.5 mm / 47 mm		
0.2 ... 4 mm <sup>2</sup> / 0.2 ... 4 mm <sup>2</sup> / 24 - 12		
-40 °C ... 85 °C		
IP20		
V2		
IEC 61643-21		

Description	Voltage $U_N$
TERMITRAB, modular terminal block with integrated surge protection, for mounting on NS 35	12 V DC 24 V DC 48 V DC 60 V DC

Ordering data		
Type	Order No.	Pcs. / Pkt.
TT-UK5/ 12DC	2794686	50
TT-UK5/ 24DC	2794699	50
TT-UK5/ 48DC	2794709	50

<b>Spacer plate</b> , compensates for level offsets when normal terminal blocks are aligned, 2.5 mm thick		
Black		
<b>Cover</b> , for terminating a row of terminal blocks		
Black		
<b>Labeling material</b>		

Accessories		
Type	Order No.	Pcs. / Pkt.
D-TERMITRAB-UK 5	2794990	50

ZB 6, see page 111

## Surge protection for measurement and control technology

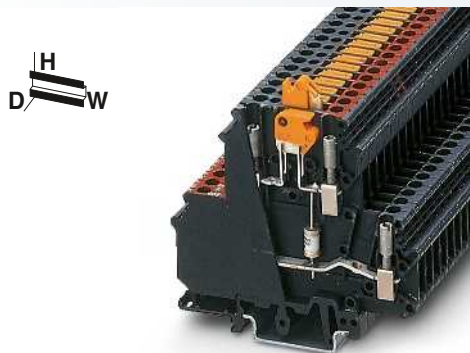

With suppressor diode, disconnect knife, direction of action: core-core

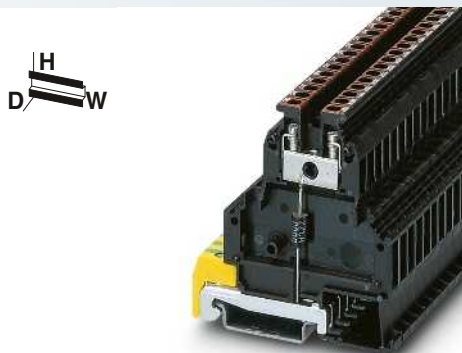

With suppressor diode, direction of action: core-ground

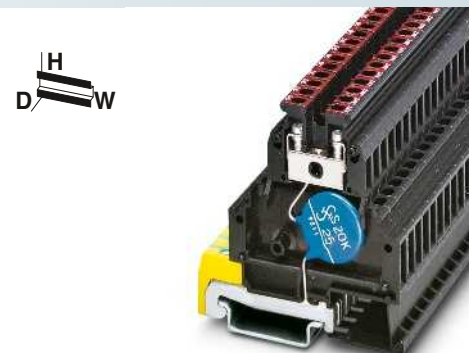

With varistor, direction of action: core-ground

Total width 6.2 mm

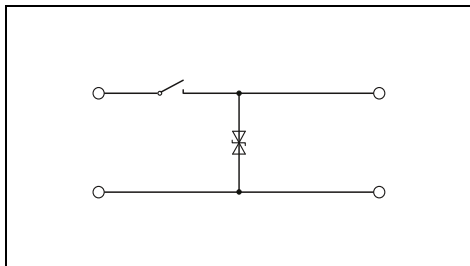

Total width 6.2 mm

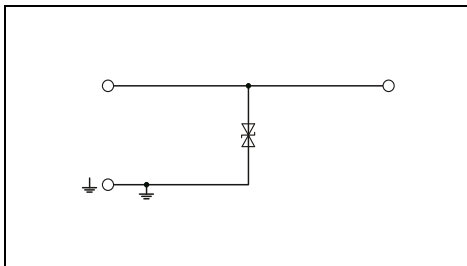

Total width 6.2 mm

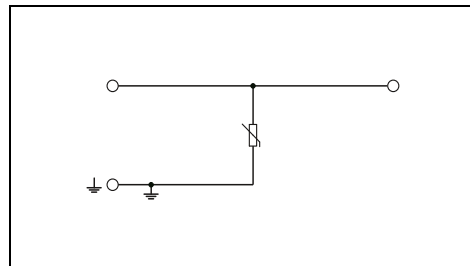

Technical data		
... 24DC	... 48DC	... 60DC
C3	C3	C3
28 V DC / 20 V AC	53 V DC / 37 V AC	70 V DC / 49 V AC
12 A (45°C)	12 A (45°C)	12 A (45°C)
169 A / - 169 A	90 A / - 90 A	69 A / - 69 A
≤ 40 V / -	≤ 80 V / -	≤ 100 V / -
6.2 mm / 80 mm / 68 mm		
0.2 ... 4 mm <sup>2</sup> / 0.2 ... 4 mm <sup>2</sup> / 24 - 12		
-40 °C ... 85 °C		
IP20		
V2		
IEC 61643-21 / DIN EN 61643-21		

Technical data		
... 12DC	... 24DC	... 48DC
C1 / C3	C3	C3
13.6 V DC / 9.5 V AC	28.2 V DC / 20 V AC	53 V DC / 37 V AC
32 A (50°C)	32 A (50°C)	32 A (50°C)
- / 346 A	- / 169 A	- / 90 A
346 A	169 A	90 A
- / ≤ 19 V	- / ≤ 41 V	- / ≤ 79 V
6.2 mm / 66.5 mm / 69.5 mm		
0.2 ... 4 mm <sup>2</sup> / 0.2 ... 4 mm <sup>2</sup> / 24 - 12		
-40 °C ... 85 °C		
IP20		
V2		
IEC 61643-21		

Technical data		
... 12DC	... 24DC	... 48DC
C1 / C2 / C3	C1 / C2 / C3	C1 / C2 / C3
14 V DC / 11 V AC	31 V DC / 11 V AC	65 V DC / 50 V AC
32 A (50°C)	32 A (50°C)	32 A (50°C)
- / 700 A	- / 700 A	- / 2 kA
2 kA	2 kA	6.5 kA
- / ≤ 45 V	- / ≤ 80 V	- / ≤ 125 V
6.2 mm / 66.5 mm / 69.5 mm		
0.2 ... 4 mm <sup>2</sup> / 0.2 ... 4 mm <sup>2</sup> / 24 - 12		
-40 °C ... 85 °C		
IP20		
V2		
IEC 61643-21		

Ordering data		
Type	Order No.	Pcs. / Pkt.
TT-UKK5-M/ 24DC	2795960	50
TT-UKK5-M/ 48DC	2795973	50
TT-UKK5-M/ 60DC	2795986	50

Ordering data		
Type	Order No.	Pcs. / Pkt.
TT-SLKK5-S- 12DC	2809597	50
TT-SLKK5-S- 24DC	2809607	50
TT-SLKK5-S- 48DC	2809610	50

Ordering data		
Type	Order No.	Pcs. / Pkt.
TT-SLKK5/ 12DC	2794893	50
TT-SLKK5/ 24DC	2794903	50
TT-SLKK5/ 48DC	2794916	50

Accessories		

Accessories		
DP-UKK 3/5 BK	2770833	50
D-UKK 3/5 BK	2770228	50

Accessories		
DP-UKK 3/5 BK	2770833	50
D-UKK 3/5 BK	2770228	50

ZB 6, see page 111

ZB 6, see page 111

ZB 6, see page 111

# Surge protection and interference filters

## Surge protection for measurement and control technology

### Surge protection direct at the sensor head

#### SURGETRAB

- Arresters in hexagonal tube with various outer threads
- **S-PT-1x2...** and **S-PT-EX(I)...** installation in signal path feed-through
- **S-PT-EX**, **S-PT-2xEX...**, and **S-PT-4-EX** installation in a separate cable gland parallel to the signal cables
- S-PT-EX... devices are approved for Ex-i and Ex-d measuring probes



Double wire (loop), floating



Double wire (loop), intrinsically safe

<b>Notes:</b>
For certifications, see page 154
For more information about EX approvals, visit <a href="http://www.phoenixcontact.com">www.phoenixcontact.com</a>
For additional safety data, visit <a href="http://www.phoenixcontact.com">www.phoenixcontact.com</a>

Total width 34 mm

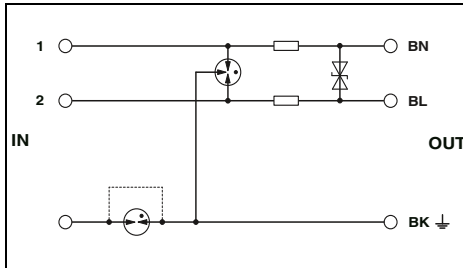

#### Technical data

Electrical data		
Maximum continuous operating voltage $U_c$	DC/AC	40 V DC / 28 V AC
Lightning test curr. $I_{imp}$ (10/350) $\mu$ s	Per path	1 kA
Nominal current $I_N$		450 mA (55°C)
Nominal discharge surge current $I_n$ (8/20) $\mu$ s		
Maximum permitted short-circuit current at installation location	Core-Core / Core-Ground	10 kA / 10 kA
		1 A
Total surge current (8/20) $\mu$ s		20 kA
Protection level $U_p$		
	Core-Core	$\leq 80$ V (C2 - 5 kA)
	Core-Ground	
Output voltage limitation at 1 kV/ $\mu$ s	Core-Core / Core-Ground	$\leq 55$ V / $\leq 450$ V (Direct grounding)
Resistance per path		2.2 $\Omega$

General data	
Dimensions W / H / D	34 mm / 34 mm / 137 mm
Temperature range	-40 °C ... 85 °C
Degree of protection in acc. with IEC 60529 / EN 60529	IP67
Test standards	IEC 61643-21

<b>Safety data</b>	
EC-type examination certificate according to ATEX	-
Identification according to ATEX	-
Maximum inner capacity $C_i$	-
Maximum inner inductance $L_i$	-
Maximum input current $I_i$	-
Maximum input voltage $U_i$	-
Maximum input power $P_i$	-

Total width 34 mm

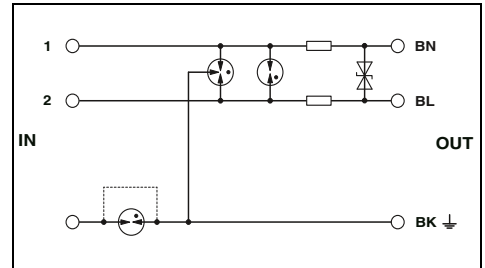

#### Technical data

Electrical data		
Maximum continuous operating voltage $U_c$	DC/AC	30 V DC / 21 V AC
Lightning test curr. $I_{imp}$ (10/350) $\mu$ s	Per path	1 kA
Nominal current $I_N$		350 mA (50°C)
Nominal discharge surge current $I_n$ (8/20) $\mu$ s		
Maximum permitted short-circuit current at installation location	Core-Core / Core-Ground	10 kA / 10 kA
		350 mA
Total surge current (8/20) $\mu$ s		
Protection level $U_p$		
	Core-Core	$\leq 50$ V (C3 - 25 A)
	Core-Ground	$\leq 1.4$ kV (C3 - 100 A)
Output voltage limitation at 1 kV/ $\mu$ s	Core-Core / Core-Ground	$\leq 50$ V / $\leq 1.4$ kV (Direct grounding)
Resistance per path		2.2 $\Omega$

General data	
Dimensions W / H / D	34 mm / 34 mm / 137 mm
Temperature range	-40 °C ... 50 °C
Degree of protection in acc. with IEC 60529 / EN 60529	IP67
Test standards	DIN EN 61643-21 / EN 60079-0 / EN 60079-11 / EN 60079-26

<b>Safety data</b>	
EC-type examination certificate according to ATEX	KEMA 06ATEX0002
Identification according to ATEX	Ex II 1G Ex ia IIC T4...T6 Ga
Maximum inner capacity $C_i$	2 nF
Maximum inner inductance $L_i$	1 $\mu$ H
Maximum input current $I_i$	350 mA (T4, T5, T6 $\leq 50$ °C)
Maximum input voltage $U_i$	30 V
Maximum input power $P_i$	3 W

#### Ordering data

Description	Voltage $U_N$
<b>SURGETRAB</b> , protective adapter for installation on measuring sensors	
Outer thread: M20 x 1.5	24 V DC
Outer thread: 1/2" 14 NPT	24 V DC
Outer thread: 3/4" 14 NPT	24 V DC
<b>SURGETRAB</b> protective adapter for installation on measuring sensors for Ex protection zones	
Outer thread: M20 x 1.5	24 V DC
Outer thread: 1/2" 14 NPT	24 V DC
Outer thread: 3/4" 14 NPT	24 V DC
Outer thread: M20 x 1.5	48 V DC
Outer thread: 1/2" 14 NPT	48 V DC

Type	Order No.	Pcs. / Pkt.
S-PT-1X2-24DC	2880668	1
S-PT-1X2-24DC-1/2"	2882569	1
S-PT-1X2-24DC-3/4"	2882598	1

#### Ordering data

Type	Order No.	Pcs. / Pkt.
S-PT-EX(I)-24DC	2880671	1
S-PT-EX(I)-24DC-1/2"	2882572	1
S-PT-EX(I)-24DC-3/4"	2882585	1



Double conductor (loop), floating, intrinsically safe, encapsulated, without decoupling resistance



2 double conductors (loops), floating, intrinsically safe, encapsulated, without decoupling resistance



4-wire with common reference potential, intrinsically safe, encapsulated, without decoupling resistance

Total width 28 mm

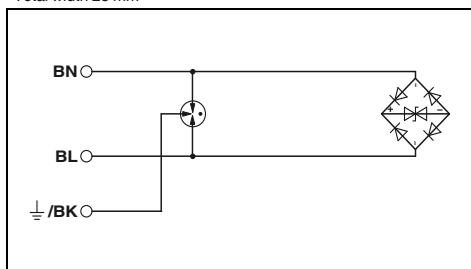

### Technical data

... 24DC	... 48DC
36 V DC / 25 V AC	53 V DC / 37 V AC
1 kA	1 kA
-	-
260 A / 10 kA	170 A / 10 kA
1 A (non-EX)	1 A (non-EX)
20 kA	20 kA
$\leq 65$ V (C3 - 10 A)	$\leq 90$ V (C3 - 10 A)
$\leq 1.1$ kV (C3 - 100 A)	$\leq 1.1$ kV (C3 - 100 A)
$\leq 60$ V / -	$\leq 80$ V / -
-	-

28 mm / 28 mm / 79 mm  
-25 °C ... 80 °C (non-EX)  
IP67

EN 61643-21 / EN 60079-0 / EN 60079-1 / EN 60079-11 / EN 60079-26 / EN 61241-0

KEMA 09ATEX0028 X	KEMA 09ATEX0028 X
II 1 G Ex ia IIC T4...T6	II 1 G Ex ia IIC T4...T6
II 2 G Ex d IIC T4...T6	II 2 G Ex d IIC T4...T6
1.65 nF	1.14 nF
1 $\mu$ H	1 $\mu$ H
500 mA	500 mA
36 V DC	53 V DC
3 W	3 W

### Ordering data

Type	Order No.	Pcs. / Pkt.
S-PT-EX-24DC	2800034	1
S-PT-EX-24DC-1/2"	2800035	1
S-PT-EX-48DC	2800053	1
S-PT-EX-48DC-1/2"	2800054	1

Total width 28 mm

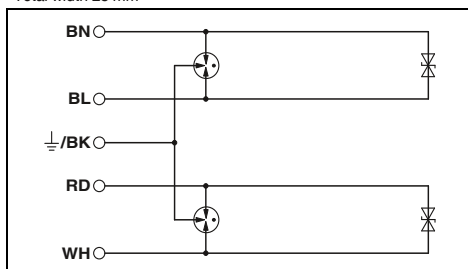

### Technical data

... 24DC	... 48DC
36 V DC / 25 V AC	53 V DC / 37 V AC
1 kA	1 kA
-	-
260 A / 10 kA	170 A / 10 kA
1 A (non-EX)	1 A (non-EX)
20 kA	20 kA
$\leq 50$ V (C3 - 10 A)	$\leq 80$ V (C3 - 10 A)
$\leq 1.1$ kV (C3 - 100 A)	$\leq 1.1$ kV (C3 - 100 A)
$\leq 50$ V / -	$\leq 80$ V / -
-	-

28 mm / 28 mm / 79 mm  
-25 °C ... 80 °C (non-EX)  
IP67

EN 61643-21 / EN 60079-0 / EN 60079-1 / EN 60079-11 / EN 60079-26 / EN 61241-0

KEMA 09ATEX0028 X	KEMA 09ATEX0028 X
II 1 G Ex ia IIC T4...T6	II 1 G Ex ia IIC T4...T6
II 2 G Ex d IIC T4...T6	II 2 G Ex d IIC T4...T6
1.65 nF	1.14 nF
1 $\mu$ H	1 $\mu$ H
500 mA	500 mA
36 V DC	53 V DC
3 W	3 W

### Ordering data

Type	Order No.	Pcs. / Pkt.
S-PT-2XEX-24DC	2800040	1
S-PT-2XEX-24DC-1/2"	2800041	1
S-PT-2XEX-48DC	2800038	1
S-PT-2XEX-48DC-1/2"	2800039	1

Total width 28 mm

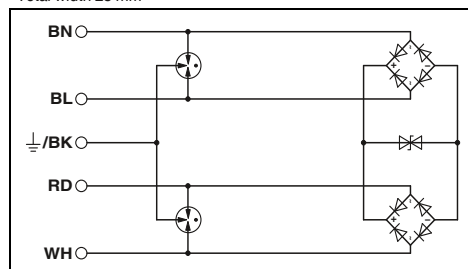

### Technical data

36 V DC / 25 V AC
1 kA
-
260 A / 10 kA
1 A (non-EX)
20 kA
$\leq 65$ V (C3 - 10 A)
$\leq 1.1$ kV (C3 - 100 A)
$\leq 60$ V / -
-

28 mm / 28 mm / 79 mm  
-25 °C ... 80 °C (non-EX)  
IP67

EN 61643-21 / EN 60079-0 / EN 60079-1 / EN 60079-11 / EN 60079-26 / EN 61241-0

KEMA 09ATEX0028 X
II 1 G Ex ia IIC T4...T6
II 2 G Ex d IIC T4...T6
1.65 nF
1 $\mu$ H
500 mA
36 V DC
3 W

### Ordering data

Type	Order No.	Pcs. / Pkt.
S-PT-4-EX-24DC	2800036	1
S-PT-4-EX-24DC-1/2"	2800037	1

# Surge protection and interference filters

## Surge protection for measurement and control technology

### COMTRAB modular

- Modular compact protection for high-density networks
- Space-saving LSA-PLUS connection technology
- Surge protection connectors for 1 - 10 double wires or 2 - 20 individual wires
- Typical installation locations include marshalling distributors
- Can be used in LSA-PLUS disconnect and control strips or CT-TERMIBLOCK
- The CTM 10-MAG surge protection card cage can be mounted with any of the different protective connectors



Double wire (loop), floating



2-wire, with common reference potential

**Notes:**  
For certifications, see page 154

Total width 9.5 mm

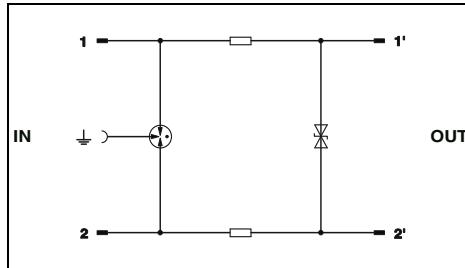

Total width 9.5 mm

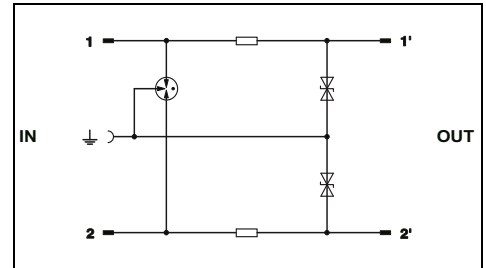

#### Technical data

Electrical data	... 12DC	... 24DC	... 60DC	... 110AC
	IEC category / EN type	B2 / C1 / C2 / C3 / D1	B2 / C1 / C2 / C3 / D1	B2 / C1 / C2 / C3 / D1
Maximum continuous operating voltage $U_c$	DC/AC ± 15 V DC / 10 V AC	DC/AC ± 30 V DC / 21 V AC	DC/AC ± 65 V DC / 50 V AC	DC/AC ± 180 V DC / -
Lightning test curr. $I_{imp}$ (10/350) $\mu$ s	1 kA	1 kA	1 kA	1 kA
Nominal current $I_N$	380 mA (25°C)	380 mA (25°C)	380 mA (25°C)	380 mA (25°C)
Nominal discharge surge current $I_n$ (8/20) $\mu$ s				
Total surge current (8/20) $\mu$ s	Core-Core / Core-Ground	5 kA / 5 kA	5 kA / 5 kA	5 kA / 5 kA
	Core-Ground	10 kA	10 kA	10 kA
Output voltage limitation at 1 kV/ $\mu$ s	Core-Core	≤ 25 V	≤ 70 V	≤ 160 V
	Core-Ground	≤ 700 V	≤ 700 V	≤ 800 V
Cut-off frequency $f_g$ (3 dB)	Symmetrical/asymmetrical in the 100 $\Omega$ system	1.2 MHz / -	2.7 MHz / -	2 MHz / -
		3.3 $\Omega$	3.3 $\Omega$	3.3 $\Omega$
Resistance per path				
General data				
Dimensions W / H / D		9.5 mm / 21 mm / 53.5 mm		
Temperature range		-25 °C ... 75 °C		
Degree of protection in acc. with IEC 60529/ EN 60529		IP20		
Inflammability class in acc. with UL 94		V0		
Test standards		IEC 61643-21		

#### Technical data

Electrical data	... 5DC	... 12DC	... 24DC	... 60DC
	IEC category / EN type	B2 / C1 / C2 / C3 / D1	B2 / C1 / C2 / C3 / D1	B2 / C1 / C2 / C3 / D1
Maximum continuous operating voltage $U_c$	DC/AC ± 6 V DC / 5 V AC	DC/AC ± 15 V DC / 10 V AC	DC/AC ± 30 V DC / 21 V AC	DC/AC ± 65 V DC / 50 V AC
Lightning test curr. $I_{imp}$ (10/350) $\mu$ s	1 kA	1 kA	1 kA	1 kA
Nominal current $I_N$	380 mA (25°C)	380 mA (25°C)	380 mA (25°C)	380 mA (25°C)
Nominal discharge surge current $I_n$ (8/20) $\mu$ s				
Total surge current (8/20) $\mu$ s	Core-Core / Core-Ground	- / 5 kA	- / 5 kA	- / 5 kA
	Core-Ground	10 kA	10 kA	10 kA
Output voltage limitation at 1 kV/ $\mu$ s	Core-Core	-	-	-
	Core-Ground	≤ 12 V	≤ 22 V	≤ 45 V
Cut-off frequency $f_g$ (3 dB)	Symmetrical/asymmetrical in the 100 $\Omega$ system	- / 700 kHz	- / 1.5 MHz	- / 2.7 MHz
		3.3 $\Omega$	3.3 $\Omega$	3.3 $\Omega$
Resistance per path				
General data				
Dimensions W / H / D		9.5 mm / 21 mm / 53.5 mm		
Temperature range		-25 °C ... 75 °C		
Degree of protection in acc. with IEC 60529/ EN 60529		IP20		
Inflammability class in acc. with UL 94		V0		
Test standards		IEC 61643-21		

#### Ordering data

Description	Voltage $U_N$	Type	Order No.	Pcs. / Pkt.
<b>COMTRAB modular</b> , surge protection for a double wire with coarse and fine protection and ohmic decoupling, DSL-compatible				
	5 V DC	CTM 1X2- 5DC	2838571	10
	12 V DC	CTM 1X2- 12DC	2838584	10
	24 V DC	CTM 1X2- 24DC	2838500	10
	60 V DC	CTM 1X2- 60DC	2838542	10
	110 V AC	CTM 1X2-110AC		
	180 V DC			

#### Ordering data

Description	Voltage $U_N$	Type	Order No.	Pcs. / Pkt.
<b>COMTRAB modular</b> , surge protection for a double wire with coarse and fine protection and ohmic decoupling, DSL-compatible				
	5 V DC	CTM 2X1- 5DC	2838571	10
	12 V DC	CTM 2X1- 12DC	2838584	10
	24 V DC	CTM 2X1- 24DC	2838500	10
	60 V DC	CTM 2X1- 60DC	2838542	10
	110 V AC			
	180 V DC			

#### Accessories

Description	Order No.	Pcs. / Pkt.
<b>Magazine</b> , with grounding rail for accommodating up to 10 LSA-PLUS protective connectors (CTM...), for insertion in CT-TERMIBLOCK or LSA-PLUS disconnect strip	2838610	5

#### Accessories

Description	Order No.	Pcs. / Pkt.
<b>Magazine</b> , with grounding rail for accommodating up to 10 LSA-PLUS protective connectors (CTM...), for insertion in CT-TERMIBLOCK or LSA-PLUS disconnect strip	2838610	5





2-wire, with common reference potential



2-wire, coarse protection, with failsafe contact



2-wire, coarse protection, with failsafe contact and current protection (Powercross)

Total width 9.5 mm

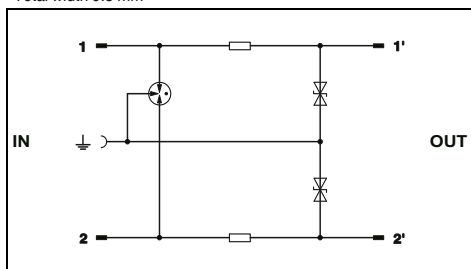

### Technical data

B2 / C1 / C2 / C3 / D1

± 180 V DC / -

1 kA  
380 mA (25 °C)

- / 5 kA  
10 kA

-  
≤ 15 V

- / Typ. 20 MHz  
3.3 Ω

9.5 mm / 21 mm / 53.5 mm

-25 °C ... 75 °C

IP20

V0

IEC 61643-21

### Ordering data

Type	Order No.	Pcs. / Pkt.
CTM 2X1-110AC	2838526	10

### Accessories

CTM 10-MAG	2838610	5
------------	---------	---

Total width 9.5 mm

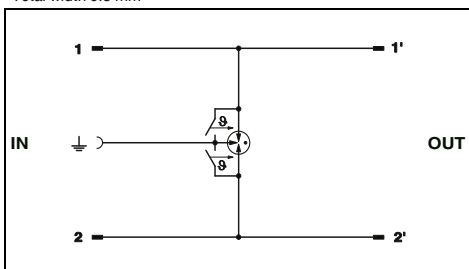

### Technical data

A2 / B1 / B2 / B3 / C1 / C2 / C3 / D1 / D2

± 180 V DC / -

1 kA  
1.5 A (25 °C)

- / 5 kA  
10 kA

-  
≤ 800 V

- / > 100 MHz

-

9.5 mm / 21 mm / 53.5 mm

-40 °C ... 85 °C

IP20

V0

IEC 61643-21

### Ordering data

Type	Order No.	Pcs. / Pkt.
CTM 2X1-180DC-GS	2838636	10

### Accessories

CTM 10-MAG	2838610	5
------------	---------	---

Total width 9.5 mm

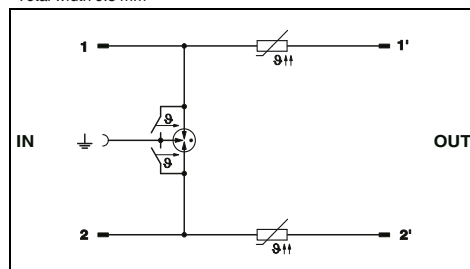

### Technical data

A2 / B1 / B2 / B3 / C1 / C2 / C3 / D1 / D2

± 180 V DC / -

1 kA  
120 mA (25 °C)

- / 5 kA  
10 kA

-  
≤ 800 V

- / > 100 MHz  
5.5 Ω

9.5 mm / 21 mm / 53.5 mm

-40 °C ... 85 °C

IP20

V0

IEC 61643-21

### Ordering data

Type	Order No.	Pcs. / Pkt.
CTM 2X1-180DC-GS-P	2838623	10

### Accessories

CTM 10-MAG	2838610	5
------------	---------	---

# Surge protection and interference filters

## Surge protection for measurement and control technology

### COMTRAB modular



#### CTM ISDN

- Tailored to the ISDN bus with basic and primary multiplex connections
- Two protective connectors are required to protect the ISDN bus

#### CTM EST

- Grounding plug to short circuit and ground the wires

Double wire (loop), ISDN S<sub>0</sub>  
(2 connectors are required for one bus)

LSA-PLUS grounding plug

<b>Notes:</b>
For certifications, see page 154
Attenuation characteristics at <a href="http://www.phoenixcontact.net/products">www.phoenixcontact.net/products</a>

Total width 9.5 mm

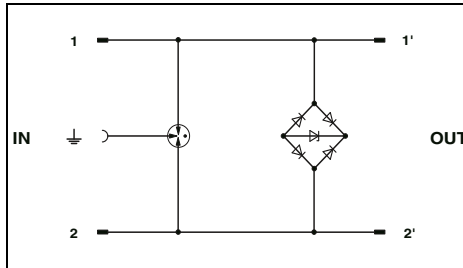

Total width 9.5 mm

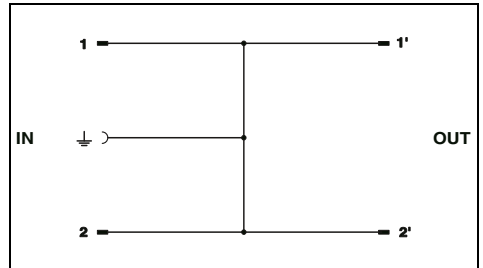

#### Technical data

<b>Electrical data</b>	
IEC category / EN type	B2 / C2 / C3 / D1 / C1
Maximum continuous operating voltage U <sub>C</sub>	± 6 V DC
Lightning test curr. I <sub>imp</sub> (10/350) μs	1 kA
Nominal current I <sub>N</sub>	1.5 A (25 °C)
Nominal discharge surge current I <sub>n</sub> (8/20) μs	
Core-Core / Core-Ground	350 A / 5 kA
Total surge current (8/20) μs	10 kA
Output voltage limitation at 1 kV/μs	
Core-Core / Core-Ground	≤ 15 V / ≤ 700 V
Cut-off frequency f <sub>g</sub> (3 dB)	
Symmetrical in the 100 Ω system	≥ 100 MHz
<b>General data</b>	
Dimensions W / H / D	9.5 mm / 21 mm / 53.5 mm
Temperature range	-25 °C ... 75 °C
Degree of protection in acc. with IEC 60529/ EN 60529	IP20
Inflammability class in acc. with UL 94	V0
Test standards	IEC 61643-21

#### Technical data

<b>Electrical data</b>	
IEC category / EN type	B2 / C2 / C3 / D1 / C1
Maximum continuous operating voltage U <sub>C</sub>	± 6 V DC
Lightning test curr. I <sub>imp</sub> (10/350) μs	1 kA
Nominal current I <sub>N</sub>	1.5 A (25 °C)
Nominal discharge surge current I <sub>n</sub> (8/20) μs	
Core-Core / Core-Ground	350 A / 5 kA
Total surge current (8/20) μs	10 kA
Output voltage limitation at 1 kV/μs	
Core-Core / Core-Ground	≤ 15 V / ≤ 700 V
Cut-off frequency f <sub>g</sub> (3 dB)	
Symmetrical in the 100 Ω system	≥ 100 MHz
<b>General data</b>	
Dimensions W / H / D	9.5 mm / 21 mm / 53.5 mm
Temperature range	-25 °C ... 75 °C
Degree of protection in acc. with IEC 60529/ EN 60529	IP20
Inflammability class in acc. with UL 94	V0
Test standards	IEC 61643-21

#### Ordering data

Description	Voltage U <sub>N</sub>
<b>COMTRAB modular</b> , surge protection for the ISDN-S <sub>0</sub> interface	
	6 V DC
<b>COMTRAB modular</b> , LSA-PLUS grounding plug to short-circuit and ground potentials in CT-TERMIblock... and disconnect strip CT 10...	

Type	Order No.	Pcs. / Pkt.
CTM ISDN	2838555	10

#### Ordering data

Type	Order No.	Pcs. / Pkt.
CTM EST	2838649	10

**COMTRAB**



For 9 wires with common reference potential

- Multi-position, plug-in modular design
- For use with CT-TERMIBLOCK and with LSA-PLUS and LSA-PROFIL disconnect and control strips
- Specially designed for higher signal voltages of 120 V and 230 V
- For controllers with a large number of signal inputs and outputs, such as those used in remote control technology or traffic light systems
- Protection modules must be inserted in the correct direction

**Notes:**  
For certifications, see page 154

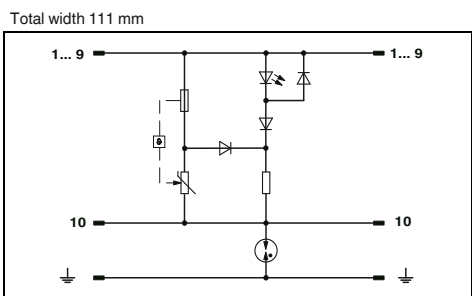

**Technical data**

<b>Electrical data</b>	
IEC category / EN type	
Maximum continuous operating voltage $U_c$	DC/AC
Nominal current $I_n$	1.5 A
Nominal discharge surge current $I_n$ (8/20) $\mu$ s	GND-Ground / Core-GND
Total surge current (8/20) $\mu$ s	5 kA / 1.5 kA
<b>General data</b>	
Dimensions W / H / D	111 mm / 22 mm / 68.5 mm
Temperature range	-40 °C ... 85 °C
Degree of protection in acc. with IEC 60529/ EN 60529	IP20
Inflammability class in acc. with UL 94	V2

C1 / C3	275 V DC / 275 V AC
5 kA / 1.5 kA	5 kA
111 mm / 22 mm / 68.5 mm	
-40 °C ... 85 °C	
IP20	
V2	

**Ordering data**

Description	Voltage $U_n$
<b>COMTRAB</b> , LSA-PLUS plug with surge protection incl. optical fault warning for nine signal circuits	230 V AC

Type	Order No.	Pcs. / Pkt.
CT 10-9VA-230AC	2830498	1

**Accessories**

**Screw terminal block**, with disconnect contacts for accommodating the CT and CTM protective connectors, design: 10 double wires

CT-TERMIBLOCK 10 DA	0441711	10
---------------------	---------	----

# Surge protection and interference filters

## Surge protection for measurement and control technology

### COMTRAB

**Notes:**  
For certifications, see page 154



For 10 double conductors, floating, without decoupling resistance

- Multi-position, plug-in modular design
- For use with CT-TERMIBLOCK and with LSA-PLUS and LSA-PROFIL disconnect and control strips
- Applications include systems with higher signal voltages
- Combined protective circuits
- Protection modules must be inserted in the correct direction

Total width 111 mm

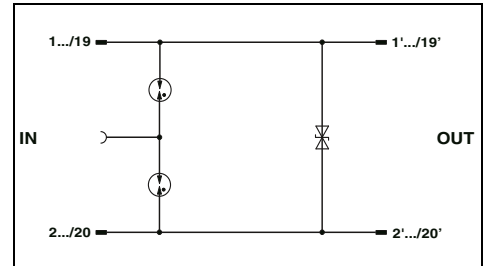

#### Technical data

Electrical data	
IEC category / EN type	C1 / C2 / C3 / D1
Maximum continuous operating voltage $U_c$	DC/AC 40 V DC / 28 V AC
Nominal current $I_n$	1.5 A (75°C)
Nominal discharge surge current $I_n$ (8/20) $\mu$ s	Core-Core / Core-Ground 119 A (25°C) / 5 kA
Total surge current (8/20) $\mu$ s	10 kA
Output voltage limitation at 1 kV/ $\mu$ s	Core-Core / Core-Ground $\leq 60$ V / $\leq 650$ V
Resistance per path	-
General data	
Dimensions W / H / D	111 mm / 22 mm / 68.5 mm
Temperature range	-25 °C ... 75 °C
Degree of protection in acc. with IEC 60529/ EN 60529	IP20
Inflammability class in acc. with UL 94	V0
Test standards	IEC 61643-21

Ordering data		
Type	Order No.	Pcs. / Pkt.
CT 10-2PE/FS-24	2807955	1

#### Accessories

<b>Screw terminal block</b> , with disconnect contacts for accommodating the CT and CTM protective connectors, design: 10 double wires		
--	--	--

CT-TERMIBLOCK 10 DA	0441711	10
---------------------	---------	----



For 10 double wires, floating, with decoupling



For 18 conductors with common reference potential, without decoupling resistance



For 18 conductors with common reference potential, with decoupling

Total width 111 mm

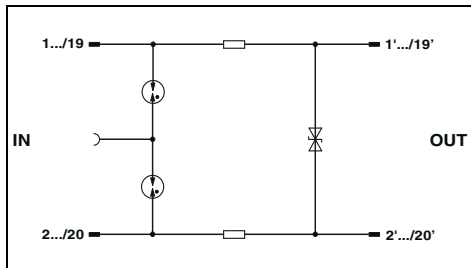

### Technical data

C1 / C2 / C3 / D1  
40 V DC / 28 V AC  
200 mA (25°C)

5 kA / 5 kA  
10 kA

≤ 60 V / ≤ 650 V  
10 Ω

111 mm / 22 mm / 68.5 mm

-25 °C ... 75 °C

IP20

V0

IEC 61643-21

Total width 111 mm

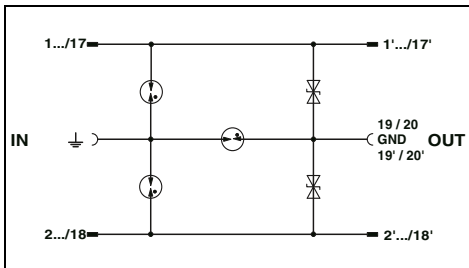

### Technical data

C1 / C2 / C3 / D1  
40 V DC / 28 V AC  
1.5 A (75°C)

214 A (25°C) / 5 kA  
10 kA

- / ≤ 650 V  
-

111 mm / 22 mm / 68.5 mm

-25 °C ... 75 °C

IP20

V0

IEC 61643-21

Total width 111 mm

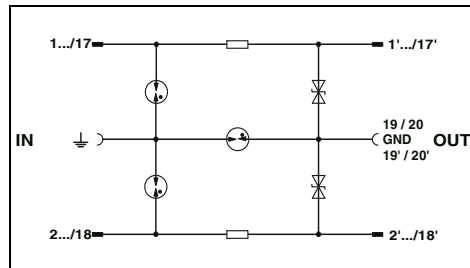

### Technical data

C1 / C2 / C3 / D1  
40 V DC / 28 V AC  
140 mA (25°C)

5 kA / 5 kA  
10 kA

- / ≤ 650 V  
22 Ω

111 mm / 22 mm / 68.5 mm

-25 °C ... 75 °C

IP20

V0

IEC 61643-21

### Ordering data

Type	Order No.	Pcs. / Pkt.
CT 10-2PE/FSR-24	2807968	1

### Accessories

CT-TERMIBLOCK 10 DA	0441711	10
---------------------	---------	----

### Ordering data

Type	Order No.	Pcs. / Pkt.
CT 10-18FS+F/PE-24	2807926	1

### Accessories

CT-TERMIBLOCK 10 DA	0441711	10
---------------------	---------	----

### Ordering data

Type	Order No.	Pcs. / Pkt.
CT 10-18FSR+F/PE-24	2807939	1

### Accessories

CT-TERMIBLOCK 10 DA	0441711	10
---------------------	---------	----

# Surge protection and interference filters

## Surge protection for measurement and control technology

### LSA-PLUS coarse protection magazine

- For use in CT-TERMIBLOCK or in LSA-PLUS and LSA-PROFIL disconnect and terminal strips

#### CT 10-2/2-GS

- For fitting with 20 two-electrode arresters filled with inert gas
- Common mode voltage coarse protection for 20 signal wires

#### CT ...-2/2-GS/3E

- Fitted with up to 10 three-electrode arresters filled with inert gas
- When the gas-filled arrester is triggered, the potentials of the three connections a-b $\frac{1}{2}$  are equalized
- Coarse protection both in the normal mode voltage branch and the common mode voltage branch for 10 double wires

#### Notes:

For dimensional drawings, see [www.phoenixcontact.net/products](http://www.phoenixcontact.net/products)



For 10 double wires (loops) and 20 two-electrode GDTs



For 10 double wires (loops) and 10 three-electrode GDTs

Total width 113 mm

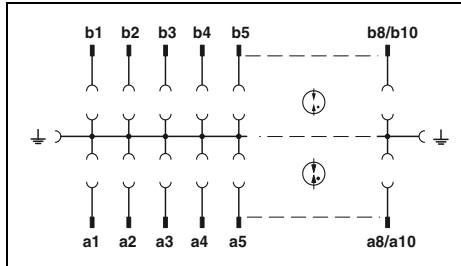

Total width 113.3 mm

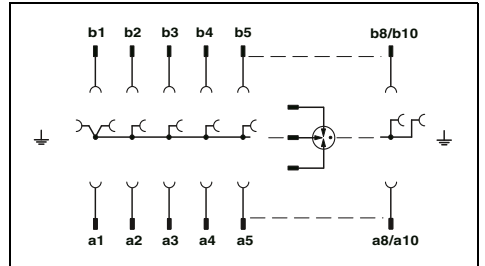

#### Ordering data

Type	Order No.	Pcs. / Pkt.
CT 10-2/2-GS	2765398	5

#### Ordering data

Type	Order No.	Pcs. / Pkt.
CT 10-2/2-GS/3E	2765408	5
CT 10-2/2-GS/3E-110AC	2920829	10

#### Accessories

Type	Order No.	Pcs. / Pkt.
SVP 2E- 48AC	2788919	10
SVP 2E-110AC	2765534	10

#### Accessories

Type	Order No.	Pcs. / Pkt.
SVP 3E-110AC	2765521	10

Description	Voltage U <sub>N</sub>
<b>Coarse protection magazine</b> , to accommodate 20 two-electrode gas-filled surge arresters, design H, bare, model: 10 double conductors	
<b>Coarse protection card cage</b> , for 10 double conductors <b>unassembled</b> , for accommodating 10 three-electrode gas-filled surge arresters	
<b>assembled</b> , with 10 three-electrode gas-filled surge arresters	110 V AC
<b>2-electrode gas-filled surge arrester filled with inert gas</b> , type H, for use in CT 10-2/2-GS coarse protection magazine	48 V AC 110 V AC
<b>3-electrode gas-filled surge arrester filled with inert gas</b> , for use in CT 10-2/2-GS/3E coarse protection magazine	110 V AC

### CT-TERMIBLOCK

**Notes:**  
For dimensional drawings, see [www.phoenixcontact.net/products](http://www.phoenixcontact.net/products)



- Screw terminal block
- For COMTRAB protective connectors
- Automatically closing feed-through/disconnect contacts
- Ground terminal blocks on both sides with plug-in connection for the protective connectors used
- Mounting on DIN rails according to EN 60715

For accommodating the CT and CTM protective connectors, with screw connection

**General data**  
Dimensions W / H / D  
Connection data solid / stranded / AWG  
Temperature range  
Degree of protection in acc. with IEC 60529/ EN 60529  
Inflammability class in acc. with UL 94

Technical data	
Dimensions W / H / D	118 mm / 43 mm / 40.9 mm
Connection data solid / stranded / AWG	0.2 ... 2.5 mm <sup>2</sup> / 0.2 ... 2.5 mm <sup>2</sup> / 24 - 14
Temperature range	-40 °C ... 85 °C
Degree of protection in acc. with IEC 60529/ EN 60529	IP20
Inflammability class in acc. with UL 94	V2

**Description**  
**Screw termination block** with disconnect contacts for accommodating the protective plugs CT and CTM, model: 10 double conductors

Ordering data		
Type	Order No.	Pcs. / Pkt.
CT-TERMIBLOCK 10 DA	0441711	10

**Marker strips**, self-adhesive, color: white, can be labeled according to customer specifications

Accessories		
Type	Order No.	Pcs. / Pkt.
SK CUS	0828492	1

### COMTRAB modular magazine

**Notes:**  
For dimensional drawings, see [www.phoenixcontact.net/products](http://www.phoenixcontact.net/products)

- For accommodating up to 10 protective connectors
- Integrated grounded rail for connecting the CTM connectors to equipotential bonding



Magazine for 10 CTM

**General data**  
Dimensions W / H / D  
Temperature range  
Degree of protection in acc. with IEC 60529/ EN 60529  
Inflammability class in acc. with UL 94

Technical data	
Dimensions W / H / D	112.5 mm / 21.8 mm / 44 mm
Temperature range	-25 °C ... 75 °C
Degree of protection in acc. with IEC 60529/ EN 60529	IP20
Inflammability class in acc. with UL 94	V0

**Description**  
**Magazine**, with a grounding rail to accommodate up to 10 LSA-PLUS protective plugs (CTM...), to insert in CT-TERMIBLOCK or LSA-PLUS disconnect strip

Ordering data		
Type	Order No.	Pcs. / Pkt.
CTM 10-MAG	2838610	5

# Surge protection and interference filters

## Surge protection for measurement and control technology

### COMTRAB disconnect strip

**Notes:**  
For dimensional drawings, see [www.phoenixcontact.net/products](http://www.phoenixcontact.net/products)

- LSA-PLUS disconnect strip
- For COMTRAB protective connectors
- For up to 10 CTM connectors

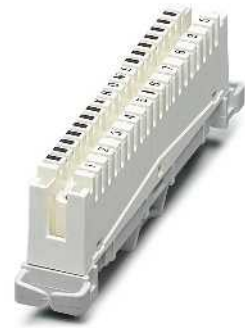

For accommodating the CT and CTM protective connectors, with LSA-PLUS connection

**Description**  
**LSA-PLUS disconnect strip** to hold the CTM and CT 10 protection modules, model: 10 double conductors

Ordering data		
Type	Order No.	Pcs. / Pkt.
CT 10-TL	2765356	5

### COMTRAB grounding rails and mounting clips

**Notes:**  
For dimensional drawings, see [www.phoenixcontact.net/products](http://www.phoenixcontact.net/products)

#### CT 1-10-ES

- For grounding up to 10 x 1DA CTM protective connectors

#### CT 10-MB...

- For accommodating 3 or 10 x LSA-PLUS disconnect or ground wire strips



Grounded rail/mounting clip

**Description**  
**Ground rail** for CTM protective plug when used in combination with LSA-PLUS disconnect strip, model: 10 double conductors

**Mounting clip**, for holding 3 disconnect or ground wire strips, model: 10 double conductors

**Mounting clip**, for holding 10 disconnect or ground wire strips, model: 10 double conductors

**Cable feed-through sleeve** for assembly troughs, for protection of the lines guided through the laminated frame

Ordering data		
Type	Order No.	Pcs. / Pkt.
CT 1-10-ES	2765547	10
CT 10-MB/ 3	2765372	2
CT 10-MB/10	2765385	2
CT-KDT	2765518	10



**Shield fast connection and labeling material**

**SSA**

- For connecting cable shielding to cable terminal points
- Can be connected to PLUGTRAB PT
- Easy assembly

**ZB...**

- For clear and logical identification
- The multi-section ZB strips can be easily separated
- Individual labeling of unlabeled ZB strips



Shield fast connection

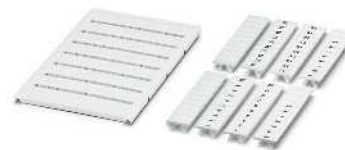

Labeling material

Total width 6 mm

Description	Ordering data			Ordering data		
	Type	Order No.	Pcs. / Pkt.	Type	Order No.	Pcs. / Pkt.
<b>Shield fast connection</b> For Ø 3 - 6 mm For Ø 5 - 10 mm	<b>SSA 3-6</b> <b>SSA 5-10</b>	<b>2839295</b> <b>2839512</b>	10 10			
<b>UniCard sheets</b> , for 6,2 mm terminal block width, 80-section, can be labeled with BLUEMARK White Orange Yellow Blue Red Green				<b>UC-TM 6</b> <b>UC-TM 6 OG</b> <b>UC-TM 6 YE</b> <b>UC-TM 6 BU</b> <b>UC-TM 6 RD</b> <b>UC-TM 6 GN</b>	<b>0818085</b> <b>0818328</b> <b>0818331</b> <b>0818344</b> <b>0818357</b> <b>0818360</b>	10 10 10 10 10 10
<b>UniCard sheets</b> , for 12 mm terminal block width, 40-section, can be labeled with BLUEMARK White Orange Yellow Blue Red Green				<b>UC-TM 12</b> <b>UC-TM 12 OG</b> <b>UC-TM 12 YE</b> <b>UC-TM 12 BU</b> <b>UC-TM 12 RD</b> <b>UC-TM 12 GN</b>	<b>0819194</b> <b>0817691</b> <b>0819204</b> <b>0817785</b> <b>0817701</b> <b>0817808</b>	10 10 10 10 10 10
<b>Zack marker strip, 10-section, unprinted</b> White White White				<b>ZB 5:UNBEDRUCKT</b> <b>ZB 6:UNBEDRUCKT</b> <b>ZB 12:UNPRINTED</b>	<b>1050004</b> <b>1051003</b> <b>0812120</b>	10 10 10
<b>Zack marker strip, printed horizontally, 10-section</b> , with consecutive numbers, e.g. 1-10, 11-20, etc. up to 91-100 White White				<b>ZB 5,LGS:FORTL.ZAHLEN</b> <b>ZB 6,LGS:FORTL.ZAHLEN</b>	<b>1050017</b> <b>1051016</b>	10 10
<b>Zack marker strip, 10-section, printed horizontally: With L1, L2, L3, N, PE</b> White White White				<b>ZB 5,LGS:L1-N,PE</b> <b>ZB 6,LGS:L1-N,PE</b> <b>ZB 12,LGS:L1-N,PE</b>	<b>1050415</b> <b>1051414</b> <b>0812146</b>	10 10 10
<b>Zack marker strip, flat, 10-section, without color print</b> White White White White				<b>ZBF 5:UNBEDRUCKT</b> <b>ZBF 6:UNBEDRUCKT</b> <b>ZBF 12:UNBEDRUCKT</b> <b>ZBF 15:UNBEDRUCKT</b>	<b>0808642</b> <b>0808710</b> <b>0809735</b> <b>0811202</b>	10 10 10 10
<b>Zack marker strip, 10-section, printed horizontally: with consecutive numbers, e.g., 1 - 10, 11 - 20 and so on up to 91 - 100</b> White White				<b>ZBF 5,LGS:FORTL.ZAHLEN</b> <b>ZBF 6,LGS:FORTL.ZAHLEN</b>	<b>0808671</b> <b>0808749</b>	10 10



Low signal levels at high frequencies require special protective circuits in data processing and telecommunications. The arresters must guarantee short reaction times to quickly limit the surge voltages to safe values, without impairing signal quality. In addition, the protective devices support system-specific connections, such as RJ45 or D-SUB connectors, and all types of network topology.

#### **DATATRAB DT - The all-round solution for protecting data interfaces**

DATATRAB DT reliably protects high-speed networks against damage caused by surge voltages. DT-LAN-CAT.6+ supports various data protocols at very high transmission speeds, such as Ethernet, Power over Ethernet (PoE), ISDN, token ring, and DS1, in a single device.

The housing has a ground connection snap-on foot into which the ground connection cover with equipotential bonding cable is inserted. DATATRAB can be therefore used either as an adapter or a DIN rail module after removing the ground connection cover.

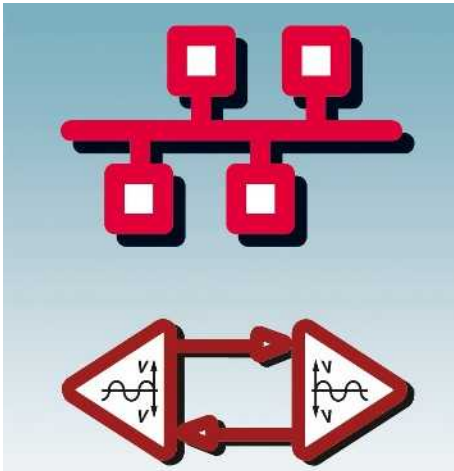

### Use

Protective devices suitable for all common applications including Ethernet, token ring, CDDI, ISDN, DS1, DSL, analog telecommunications, RS-485, RS-232, V.11, etc. are available.

The circuit breakers also support Power over Ethernet (PoE) in Mode A and B versions.



### Speed

Used in EDP systems with a transmission speed of up to 10 Gbps (CAT.6/CLASS E<sub>a</sub>) and in telecommunications networks with 16 Mbps (ADSL2+).



### Versatile

The DATATRAB product range can offer a suitable protective device for many and varied applications. The protective devices are simply installed between the signal paths with interfaces for RJ11/12, RJ45, D-SUB, or screw connection.



### Other designs

Other application-specific protective devices include:

- Two-part plug-in protective devices in the PLUGTRAB product range
- Combined adapters for the power supply and MAINTRAB interfaces
- Narrow plug-in arresters for COMTRAB modular marshalling distributors

# Surge protection and interference filters

## Surge protection for information technology and telecommunications

### Surge protection for Ethernet/ PROFINET networks with twisted pair cabling

#### DT-LAN-CAT.6+

- Suitable for category 6 high-speed data networks
- Reliable transmission rates up to 10 Gbps
- Protective adapter for eight signal paths via RJ45 connector
- Can be installed in a control cabinet by removing a ground connection adapter

#### D-LAN-CAT.5-FP

- Suitable for category 5 data networks
- Reliable transmission speeds up to 1 Gbps
- Protective adapter for eight signal paths via RJ45 connector

#### D-LAN-19"

- 19" rack for installation in storey distributors
- Up to 24 ports with RJ45 connection
- Reliable transmission speeds up to 1 Gbps
- Protection of all eight signal wires of the data cable
- Indirect grounding via a gas-filled surge arrester in the housing
- Direct grounding via a connection on the housing

#### DATA-PLUGTRAB PT 5-HF

- Protection for up to five signal wires
- For high transmission speeds
- High discharge capacity
- Connectors can be checked with CHECKMASTER

\* **Note:** PT .x.-BE connections 9/10 (GND) are linked directly to the mounting foot.

**Notes:**  
For certifications, see page 154



For LAN interfaces (Class E<sub>A</sub>/CAT 6) including PoE and ISDN S0 protection

Total width 25 mm

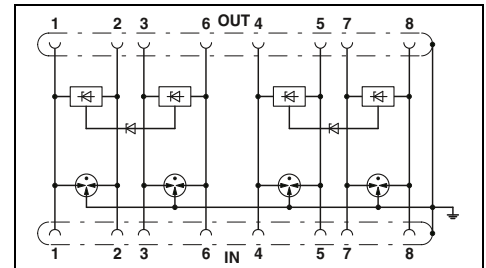

#### Technical data

Electrical data		General data	
IEC category / EN type	B2 / C1 / C2 / C3 / D1	Dimensions W / H / D	25 mm / 103 mm / 63 mm
Maximum continuous operating voltage U <sub>C</sub>	≤ 3.3 V DC (± 60 V DC/PoE+)	Temperature range	-40 °C ... 70 °C
Nominal current I <sub>N</sub>	≤ 1.5 A (25°C)	Degree of protection in acc. with IEC 60529/ EN 60529	IP20
Nominal discharge surge current I <sub>N</sub> (8/20) μs	100 A / 2 kA (per signal pair)	Inflammability class in acc. with UL 94	-
Total surge current (8/20) μs	10 kA	Connection method	RJ45
Protection level U <sub>p</sub>	Core-Core / Core-Ground	Core-Core / Core-Ground	≤ 9 V (B2 - 1 kV/25 A) / ≤ 700 V (C2 - 4 kV/2 kA)
Output voltage limitation at 1 kV/μs	Core-Core / Core-Ground	Core-Core / Core-Ground	≤ 9 V / ≤ 700 V
Cut-off frequency f <sub>g</sub> (3 dB)	Symmetrical	In a 100 Ω system	> 500 MHz
Test standards		IEC 61643-21 / EN 50173-1 / ISO/IEC 11801-Am.1	

#### Ordering data

Description	Type	Order No.	Pcs. / Pkt.
<b>DATATRAB adapter</b> , protective adapter to be inserted into the data line	<b>DT-LAN-CAT.6+</b>	<b>2881007</b>	<b>1</b>
<b>DATATRAB</b> , for use in Ethernet, token ring, FDDI/CDDI in acc. with Cat.D/CAT5e EN 50173 (1000Base-T)			
24 ports			
20 ports			
16 ports			
12 ports			
8 ports			
4 ports			
<b>Surge protection PCB</b> as replacement or for retrofitting in D-LAN-19"... products incl. RJ45 sockets			
4 ports			
<b>Patch cable</b> , CAT6, preassembled	<b>FL CAT6 PATCH 1,0</b>	<b>2891385</b>	<b>10</b>
<b>PLUGTRAB plug</b> , with protection circuit for plugging into base element PT			
<b>PLUGTRAB base element</b> , for mounting on NS 35			
Bridge between 3/4 (±) and 9/10			



For LAN interfaces (Class D/CAT 5) including PoE and ISDN S0 protection



For data interfaces, with RJ45 connection Class D/CAT5e



Plug-in arrester with screw connection, for five conductors, with common reference potential

Total width 28 mm

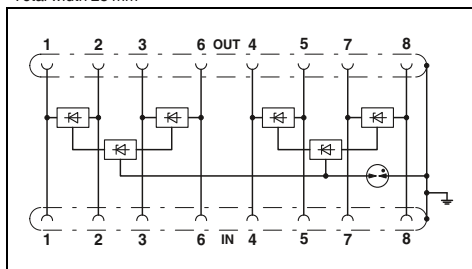

### Technical data

B2 / C1  
 $\leq 5 \text{ V DC}$  ( $\pm 57 \text{ V DC/PoE}$ )  
 $\leq 1.5 \text{ A}$  ( $25^\circ\text{C}$ )

350 A / 350 A

$\leq 35 \text{ V}$  (C1 - 700 V/350 A)  $\leq 110 \text{ V}$  (C1 - 700 V/350 A - PoE) / -

$\leq 25 \text{ V}$  /  $\leq 750 \text{ V}$

> 100 MHz

28 mm / 110 mm / 60 mm  
 $-40^\circ\text{C} \dots 85^\circ\text{C}$   
 IP20  
 V0  
 RJ45

IEC 61643-21/A1 / GB/T 18802.21 / EN 61643-21/A1

Total width 483 mm

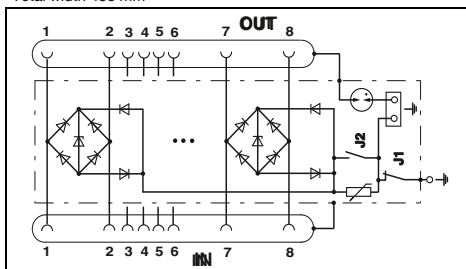

### Technical data

C1 / C2 / C3 / B3  
 $6 \text{ V DC}$   
 $1.5 \text{ A}$  ( $25^\circ\text{C}$ )

350 A / 350 A  
 10 kA

$\leq 50 \text{ V}$  (C1, 500 V/250 A) /  $\leq 40 \text{ V}$  (C1, 500 V/250 A (J2 ON))

$\leq 20 \text{ V}$  /  $\leq 30 \text{ V}$  (J2 plugged)

> 100 MHz

483 mm / 44 mm / 160 mm  
 $-40^\circ\text{C} \dots 80^\circ\text{C}$   
 IP20  
 -  
 RJ45

IEC 61643-21

Total width 17.7 mm

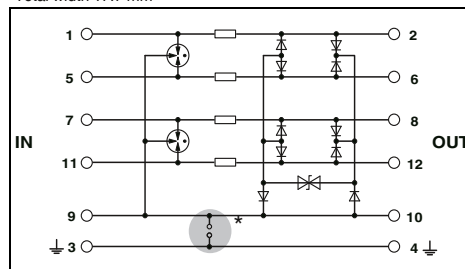

### Technical data

C1 / C2 / C3 / D1  
 $5.2 \text{ V DC}$  /  $3.6 \text{ V AC}$   
 $450 \text{ mA}$  ( $45^\circ\text{C}$ )

10 kA / 10 kA  
 20 kA

$\leq 34 \text{ V}$  (C3 - 25 A) /  $\leq 34 \text{ V}$  (C3 - 25 A)

$\leq 15 \text{ V}$  /  $\leq 15 \text{ V}$

Typ. 70 MHz

17.7 mm / 90 mm / 65.5 mm  
 $-40^\circ\text{C} \dots 85^\circ\text{C}$   
 IP20  
 V0  
 Screw connection (in connection with the base element)

IEC 61643-21/A1 / EN 61643-21/A1

### Ordering data

Type	Order No.	Pcs. / Pkt.
D-LAN-CAT.5-FP	2800723	1
FL CAT6 PATCH 1,0	2891385	10

### Ordering data

Type	Order No.	Pcs. / Pkt.
D-LAN-19"-24	2838791	1
D-LAN-19"-20	2880134	1
D-LAN-19"-16	2880147	1
D-LAN-19"-12	2880150	1
D-LAN-19"-8	2880163	1
D-LAN-19"-4	2880176	1
D-LAN-19"-D-P	2880192	1

### Ordering data

Type	Order No.	Pcs. / Pkt.
PT 5-HF-5 DC-ST	2838762	10
PT 2X2-BE	2839208	10

# Surge protection and interference filters

## Surge protection for information technology and telecommunications

### Protection for RS-232 interfaces

#### DT-UFB-V24/S

- Connection: 9-pos. D-SUB and 25-pos. D-SUB
- For data and handshake cables

#### PLUGTRAB PT 3-HF-12DC

- Connection: Screw terminal blocks
- For high transmission speeds
- High discharge capacity
- Connectors can be checked with CHECKMASTER

#### Pin assignment DT-UFB-V24/S-9-SB

- 1,2,3,4,6,7,8,9 Data lines
- 5 Signal ground (Ground)

#### Pin assignment

#### DT-UFB-V24/S-SB-SET

- 2,3,4,5,6,8,20,22 data lines
- 7 Signal ground (Ground)

#### Pin assignment PT 3-HF-12DC:

- 7,11 Data lines
- 9 Signal ground (Ground)
- 3  $\perp$

\* **Note:** PT .x.+F-BE connections 9/10 (GND) are linked to the mounting foot via a gas-filled surge arrester.

<b>Notes:</b>
For certifications, see page 154



Protective adapter with 9-pos. D-SUB

Total width 25 mm

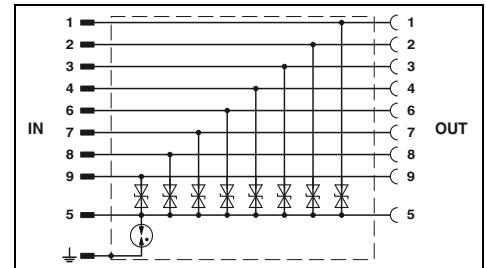

#### Technical data

<b>Electrical data</b>	
IEC category / EN type	B2 / C1 / C2 / C3
Maximum continuous operating voltage $U_c$	15 V DC / 10 V AC
Nominal current $I_n$	$\leq 1$ A (25°C)
Nominal discharge surge current $I_n$ (8/20) $\mu$ s	
Core-Earth/Core-GND	$\leq 250$ A / $\leq 250$ A
Total surge current (8/20) $\mu$ s	5 kA
Protection level $U_p$	
Core-Core / Core-Ground	$\leq 55$ V (C1 - 250 A) / $\leq 450$ V (C1 - 250 A)
Cut-off frequency fg (3 dB)	
In a 100 $\Omega$ system	Symmetrical / Asymmetrical
	Typ. 2.5 MHz / Typ. 1.3 MHz
<b>General data</b>	
Dimensions W / H / D	25 mm / 110 mm / 63 mm
Temperature range	-40 °C ... 85 °C
Degree of protection in acc. with IEC 60529/ EN 60529	IP20
Inflammability class in acc. with UL 94	-
Connection method	D-SUB-9
<b>Test standards</b>	DIN EN 61643-21 / IEC 61643-21

#### Ordering data

Description	Type	Order No.	Pcs. / Pkt.
<b>DATATRAB-Adapter</b> , protective adapter for inserting into the data line for protecting the RS-232 interface with D-SUB-9 connector			
<b>DATATRAB-Adapter</b> , protective adapter for inserting into the data line for protecting the RS-232 interface with D-SUB-25 adapter cable			
<b>PLUGTRAB plug</b> , with protection circuit for plugging into base element PT			
<b>PLUGTRAB base element</b> , for mounting on NS 35			
with a gas-filled surge arrester between the 3/4 ( $\perp$ ) and the 9/10 connections			
	<b>DT-UFB-V24/S-9-SB</b>	<b>2803069</b>	<b>1</b>

#### Accessories

<b>Labeling material</b>
--------------------------



Protective adapter with 9-pos. D-SUB and adapter cable with 25-pos. D-SUB



Plug-in arrester with screw connection, for three conductors, with common reference potential

Total width 25 mm

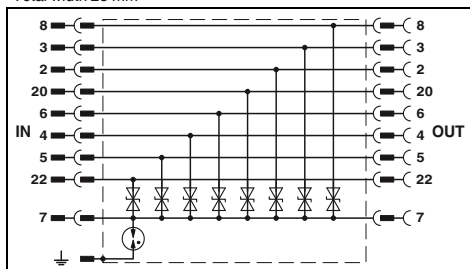

Technical data

B2 / C1 / C2 / C3  
15 V DC / 10 V AC  
≤ 1 A (25°C)

≤ 250 A / ≤ 250 A  
5 kA

≤ 55 V (C1 - 250 A) / ≤ 450 V (C1 - 250 A)

Typ. 2.5 MHz / Typ. 1.3 MHz

25 mm / 110 mm / 63 mm  
-40 °C ... 85 °C  
IP20  
-  
D-SUB-25

DIN EN 61643-21 / IEC 61643-21

Total width 17.7 mm

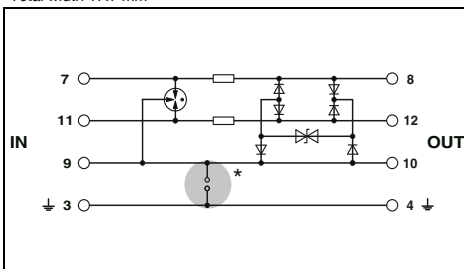

Technical data

C1 / C2 / C3 / D1  
14 V DC / 9.8 V AC  
450 mA (45°C)

10 kA / 10 kA  
20 kA

≤ 45 V (C3 - 25 A) / ≤ 45 V (C3 - 25 A)

Typ. 70 MHz / -

17.7 mm / 90 mm / 65.5 mm  
-40 °C ... 85 °C  
IP20  
V0  
Screw connection (in connection with the base element)

IEC 61643-21/A1 / EN 61643-21/A1

Ordering data

Type	Order No.	Pcs. / Pkt.
DT-UFB-V24/S-SB-SET	2803072	1

Accessories

Ordering data

Type	Order No.	Pcs. / Pkt.
PT 3-HF-12DC-ST	2858043	10
PT 1X2+F-BE	2856126	10

Accessories

ZBF ..., see page 111

# Surge protection and interference filters

## Surge protection for information technology and telecommunications

### Surge protection for V.11/RS-422 interfaces

- For floating signal circuits or signal cables
- For high data transmission rates
- Connectors can be checked with CHECKMASTER

#### Pin assignment PT 5-HF-12DC:

- 1,5 Data line pair 1: T(A), T(B)
- 7,11 Data line pair 2: R(A), R(B)
- 9 Signal ground (Ground)
- 3  $\perp$

\* **Note:** PT .x.+F-BE connections 9/10 (GND) are linked to the mounting foot via a gas-filled surge arrester.

<b>Notes:</b>
For certifications, see page 154
Attenuation characteristics at <a href="http://www.phoenixcontact.net/products">www.phoenixcontact.net/products</a>



Plug-in arrester with screw connection, for five conductors, with common reference potential

Total width 17.7 mm

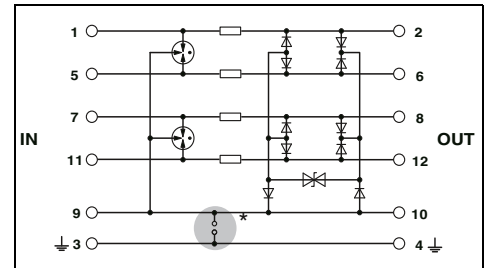

#### Technical data

<b>Electrical data</b>	
IEC category / EN type	C1 / C2 / C3 / D1
Maximum continuous operating voltage $U_c$	14 V DC / 9.8 V AC
Nominal current $I_n$	450 mA (45°C)
Nominal discharge surge current $I_n$ (8/20) $\mu$ s	
	Core-Core / Core-Ground
Total surge current (8/20) $\mu$ s	10 kA / 10 kA
Protection level $U_p$	20 kA
	Core-Core / Core-Ground
Cut-off frequency fg (3 dB)	$\leq 45$ V (C3 - 25 A) / $\leq 45$ V (C3 - 25 A)
In a 100 $\Omega$ system	Symmetrical
<b>General data</b>	
Dimensions W / H / D	17.7 mm / 90 mm / 65.5 mm
Temperature range	-40 °C ... 85 °C
Degree of protection in acc. with IEC 60529/ EN 60529	IP20
Inflammability class in acc. with UL 94	V0
Test standards	IEC 61643-21/A1 / EN 61643-21/A1

<b>Technical data</b>		
C1 / C2 / C3 / D1		
14 V DC / 9.8 V AC		
450 mA (45°C)		
Core-Core / Core-Ground		
10 kA / 10 kA		
20 kA		
Core-Core / Core-Ground		
$\leq 45$ V (C3 - 25 A) / $\leq 45$ V (C3 - 25 A)		
Symmetrical		
Typ. 70 MHz		
<b>General data</b>		
17.7 mm / 90 mm / 65.5 mm		
-40 °C ... 85 °C		
IP20		
V0		
IEC 61643-21/A1 / EN 61643-21/A1		

#### Ordering data

Description	Nominal voltage $U_N$
<b>PLUGTRAB connector</b> , with protective circuit for inserting in PT base element	12 V DC
<b>PLUGTRAB base element</b> , for mounting on NS 35	
Gas-filled surge arrester between 3/4 ( $\perp$ ) and 9/10	

Type	Order No.	Pcs. / Pkt.
<b>PT 5-HF-12 DC-ST</b>	2838775	10
<b>PT 2X2+F-BE</b>	2839224	10

#### Accessories

<b>Labeling material</b>
--------------------------

ZBF ..., see page 111
-----------------------



### Surge protection for TTY interfaces

<b>Notes:</b>
For certifications, see page 154
Attenuation characteristics at <a href="http://www.phoenixcontact.net/products">www.phoenixcontact.net/products</a>

- For floating signal circuits or signal cables
- Low voltage limitation
- Fast response
- High discharge capacity
- Connectors can be checked with CHECKMASTER

#### Pin configuration PT 2x2-24DC...:

- 1/5 data line pair A
- 7/11 data line pair B
- 3  $\perp$

#### \* Note:

Various grounding options for the base elements:

**PT .x.-BE** connections 9/10 (GND) directly connected to the mounting foot.

**PT .x.+F-BE** connection 9/10 (GND) connected to the mounting foot via a gas-filled surge arrester.



Two double wires (loops), floating, for 20 mA current loops

Total width 17.7 mm

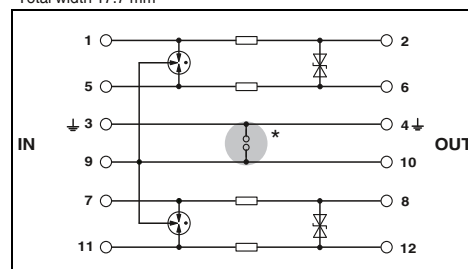

#### Technical data

<b>Electrical data</b>		
IEC category / EN type		C1 / C2 / C3 / D1
Maximum continuous operating voltage $U_c$		28 V DC / 20 V AC
Nominal current $I_N$		450 mA (45°C)
Nominal discharge surge current $I_n$ (8/20) $\mu$ s	Core-Core / Core-Ground	10 kA / 10 kA
Total surge current (8/20) $\mu$ s		20 kA
Protection level $U_p$	Core-Core / Core-Ground	$\leq 50$ V (C3 - 25 A) / -
Cut-off frequency fg (3 dB)		Typ. 6 MHz
In a 50 $\Omega$ system	Symmetrical	
<b>General data</b>		
Dimensions W / H / D		17.7 mm / 90 mm / 65.5 mm
Temperature range		-40 °C ... 85 °C
Degree of protection in acc. with IEC 60529/ EN 60529		IP20
Inflammability class in acc. with UL 94		V0
Test standards		IEC 61643-21 / DIN EN 61643-21 / UL 497B

#### Ordering data

Description	Nominal voltage $U_N$	Type	Order No.	Pcs. / Pkt.
<b>PLUGTRAB connector</b> , with protective circuit for inserting in PT base element	24 V DC	<b>PT 2X2-24DC-ST</b>	2838228	10
<b>PLUGTRAB base element</b> , for mounting on NS 35		<b>PT 2X2-BE</b>	2839208	10
		<b>PT 2X2+F-BE</b>	2839224	10

#### Accessories

<b>Shield fast connection</b>				
For $\varnothing$ 3-6 mm		<b>SSA 3-6</b>	2839295	10
For $\varnothing$ 5-10 mm		<b>SSA 5-10</b>	2839512	10
<b>Labeling material</b>		ZBF ...	see page 111	

# Surge protection and interference filters

## Surge protection for information technology and telecommunications

### Surge protection for RS-485 interfaces

#### PLUGTRAB PT 5-HF

- High transmission speed
- Fast response time
- High discharge capacity
- Connectors can be checked with CHECKMASTER

#### PLUGTRAB PT-IQ 5-HF

- Surge protection system
- Collective message about supply and remote module
- Multi-level, floating remote signaling
- System supplied via DIN rail bus
- PT-IQ...-UT base element with screw connection technology
- PT-IQ...-PT base element with push-in connection technology

#### Pin assignment PT 5-HF...:

- 1,5 Data line pair 1 T(A)/T(B)
- 7,11 Data line pair 2 R(A)/R(B)
- 9 Signal ground (Ground)
- 3  $\perp$

#### DATATRAB DT-UFB-485

- Adapter type
- 9-pos. D-SUB connection
- DIN rail mounting possible by removing the cap

#### Pin assignment DT-UFB-485:

- 3,8 Data line pair 1 T(A)/T(B)
- 4,9 Data line pair 2 R(A)/R(B)
- 2,7 Signal ground (Ground)
- $\perp$   $\perp$

#### \* Note:

Various grounding options for the base elements:

**PT .x.-BE** connections 9/10 (GND) directly connected to the mounting foot.

**PT .x.+F-BE** connection 9/10 (GND) connected to the mounting foot via a gas-filled surge arrester.

<b>Notes:</b>
For certifications, see page 154
Attenuation characteristics at <a href="http://www.phoenixcontact.net/products">www.phoenixcontact.net/products</a>



Plug-in arrester with screw connection, for five conductors, with common reference potential

Total width 17.7 mm

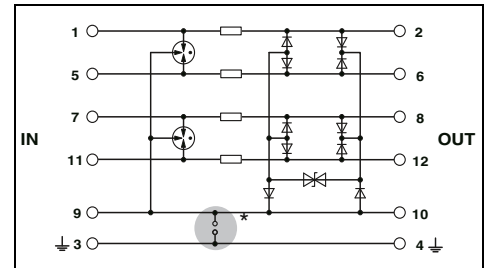

#### Technical data

Electrical data	Core-Core / Core-Ground	Core-Core / Core-Ground
IEC category / EN type	Core-Core / Core-Ground	Core-Core / Core-Ground
Maximum continuous operating voltage $U_c$	10 kA / 10 kA	10 kA / 10 kA
Nominal current $I_n$	20 kA	20 kA
Nominal discharge surge current $I_n$ (8/20) $\mu$ s	$\leq 34$ V (C3 - 25 A) / -	$\leq 45$ V (C3 - 25 A) / $\leq 45$ V (C3 - 25 A)
Total surge current (8/20) $\mu$ s	Typ. 70 MHz	Typ. 70 MHz
Protection level $U_p$	-	-
Cut-off frequency $f_g$ (3 dB)	17.7 mm / 90 mm / 65.5 mm	
In a 100 $\Omega$ system	-40 °C ... 85 °C	
In a 150 $\Omega$ system	IP20	
General data	V0	
Dimensions W / H / D	Screw connection (in connection with the base element)	
PT-IQ...UT dimensions W/H/D	IEC 61643-21/A1 / EN 61643-21/A1	
PT-IQ...PT dimensions W/H/D		
Temperature range		
Degree of protection in acc. with IEC 60529/ EN 60529		
Inflammability class in acc. with UL 94		
Connection method		
Test standards		

#### Ordering data

Description	Nominal voltage $U_N$	Type	Order No.	Pcs. / Pkt.
<b>PLUGTRAB connector</b> , with protective circuit for inserting in PT base element	5 V DC 12 V DC	<b>PT 5-HF- 5 DC-ST</b> <b>PT 5-HF-12 DC-ST</b>	<b>2838762</b> <b>2838775</b>	10 10
<b>PLUGTRAB base element</b> , for mounting on NS 35		<b>PT 2X2-BE</b> <b>PT 2X2+F-BE</b>	<b>2839208</b> <b>2839224</b>	10 10
Bridge between 3/4 ( $\perp$ ) and 9/10 Gas-filled surge arrester between 3/4 ( $\perp$ ) and 9/10 <b>MCR-PLUGTRAB</b> , consisting of a plug, base element, and DIN rail bus, with screw connection technology				
Bridge between 3/4 ( $\perp$ ) and 9/10 Bridge between 3/4 ( $\perp$ ) and 9/10 <b>MCR-PLUGTRAB</b> , consisting of a plug, base element, and DIN rail bus, with push-in connection technology				
Bridge between 3/4 ( $\perp$ ) and 9/10 Bridge between 3/4 ( $\perp$ ) and 9/10 <b>DATATRAB-Adapter</b> , Protective adapter to be inserted in the data line for the protection of the RS-485 interfaces				

#### Accessories

#### Marking material

ZBF ..., see page 111

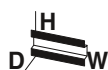

5-wire with common reference potential,  
9/10 connection grounded directly



5-wire with common reference potential,  
9/10 connection grounded via gas-filled surge  
arrester



Protective adapter with 9-pos. D-SUB

Total width 17.7 mm

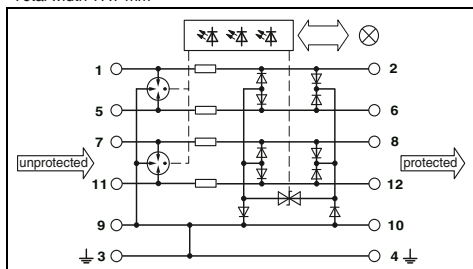

Total width 17.7 mm

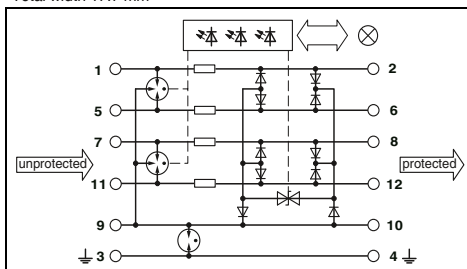

Total width 25 mm

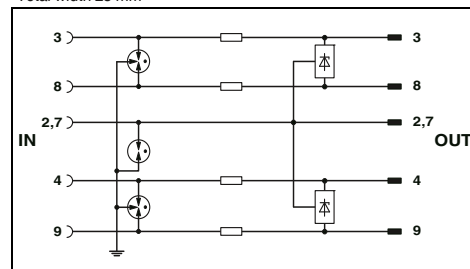

### Technical data

... 5DC	... 12DC
C1 / C2 / C3 / D1	C1 / C2 / C3 / D1
6 V DC / 4 V AC	15 V DC / 10 V AC
600 mA (up to 40 °C)	600 mA (up to 40 °C)
10 kA / 10 kA	10 kA / 10 kA
20 kA	20 kA
≤ 30 V (C3 - 25 A) / -	≤ 40 V (C3 - 25 A) / -
-	-
> 60 MHz	> 60 MHz

17.7 mm / 91 mm / 77.5 mm  
17.7 mm / 91 mm / 77.5 mm  
17.7 mm / 109.3 mm / 77.5 mm  
-40 °C ... 70 °C  
IP20  
V0

Screw connection / Push-in connection

EN 61643-21/A1 / IEC 61643-21/A2 / EN 61000-6-2/A1 /

### Technical data

... 5DC	... 12DC
C1 / C2 / C3 / D1	C1 / C2 / C3 / D1
6 V DC / 4 V AC	15 V DC / 10 V AC
600 mA (up to 40 °C)	600 mA (up to 40 °C)
10 kA / 10 kA	10 kA / 10 kA
20 kA	20 kA
≤ 30 V (C3 - 25 A) / -	≤ 40 V (C3 - 25 A) / -
-	-
> 60 MHz	> 60 MHz

17.7 mm / 91 mm / 77.5 mm  
17.7 mm / 91 mm / 77.5 mm  
17.7 mm / 109.3 mm / 77.5 mm  
-40 °C ... 70 °C  
IP20  
V0

Screw connection / Push-in connection

EN 61643-21/A1 / IEC 61643-21/A2 / EN 61000-6-2/A1 /

### Technical data

B2 / C1 / C2 / C3 / D1
12 V DC / -
≤ 380 mA (25 °C)
≤ 5 kA / ≤ 5 kA
10 kA
≤ 30 V (C1 - 500 A) / ≤ 700 V (C1 - 500 A)
Typ. 50 MHz
-

25 mm / 110 mm / 63 mm

-40 °C ... 85 °C

IP20

-

D-SUB-9

DIN EN 61643-21

### Ordering data

Type	Order No.	Pcs. / Pkt.
PT-IQ-5-HF-5DC-UT	2800797	1
PT-IQ-5-HF-12DC-UT	2800799	1
PT-IQ-5-HF-5DC-PT	2801291	1
PT-IQ-5-HF-12DC-PT	2801293	1

### Ordering data

Type	Order No.	Pcs. / Pkt.
PT-IQ-5-HF+F-5DC-UT	2800798	1
PT-IQ-5-HF+F-12DC-UT	2800801	1
PT-IQ-5-HF+F-5DC-PT	2801292	1
PT-IQ-5-HF+F-12DC-PT	2801295	1

### Ordering data

Type	Order No.	Pcs. / Pkt.
DT-UFB-485/BS	2920612	1

### Accessories

ZBF ..., see page 111

### Accessories

ZBF ..., see page 111

### Accessories

# Surge protection and interference filters

## Surge protection for information technology and telecommunications

### Surge protection for the INTERBUS remote bus

#### DATATRABDT-UFB-IB-RBI/ -RBO

- Adapter type
- 9-pos. D-SUB connection
- For remote bus modules
- DIN rail mounting possible by removing the cap
- D-SUB cable included

#### PLUGTRAB PT 5-HF

- High transmission speed
- Fast response time
- High discharge capacity
- Connectors can be checked with CHECKMASTER

\* **Note:** PT .x.+F-BE connections 9/10 (GND) are linked to the mounting foot via a gas-filled surge arrester.

#### PLUGTRAB PT-IQ 5-HF

- Surge protection system
- Collective message about supply and remote module
- Multi-level, floating remote signaling
- System supplied via DIN rail bus
- Base element with screw connection technology

<b>Notes:</b>
For certifications, see page 154
Attenuation characteristics at <a href="http://www.phoenixcontact.net/products">www.phoenixcontact.net/products</a>



Protective adapters for 5-wire remote bus input

Total width 25 mm

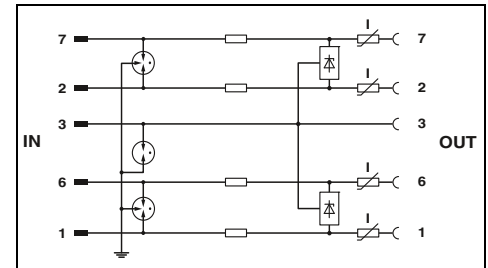

#### Technical data

<b>Electrical data</b>		
IEC category / EN type		B2 / C1 / C2 / C3 / D1
Maximum continuous operating voltage $U_c$		5.8 V DC / -
Nominal current $I_n$		≤ 180 mA (25°C)
Nominal discharge surge current $I_n$ (8/20) μs		
	Core-Core / Core-Ground	≤ 5 kA / ≤ 5 kA
Total surge current (8/20) μs		10 kA
Protection level $U_p$		
	Core-Core / Core-Ground	≤ 20 V (C1 - 500 A) / ≤ 700 V (C1 - 500 A)
Cut-off frequency fg (3 dB)		
In a 100 Ω system	Symmetrical	≥ 100 MHz
In a 150 Ω system	Symmetrical	≥ 100 MHz
<b>General data</b>		
Dimensions W / H / D		25 mm / 110 mm / 63 mm
Temperature range		-40 °C ... 85 °C
Degree of protection in acc. with IEC 60529/ EN 60529		IP20
Inflammability class in acc. with UL 94		-
Connection method		D-SUB-9
<b>Test standards</b>		DIN EN 61643-21 / IEC 61643-21

#### Ordering data

Description	Nominal voltage $U_N$	Type	Order No.	Pcs. / Pkt.
<b>PLUGTRAB connector</b> , with protective circuit for inserting in PT base element	5 V DC			
<b>PLUGTRAB base element</b> , for mounting on NS 35				
Gas-filled surge arrester between 3/4 (±) and 9/10				
<b>DATATRAB adapter</b> , protective adapters for inserting into the data line		<b>DT-UFB-IB-RBI</b>	<b>2800055</b>	<b>1</b>
<b>MCR-PLUGTRAB</b> , consisting of a plug, base element, and DIN rail bus				
Gas-filled surge arrester between 3/4 (±) and 9/10				
<b>TERMITRAB</b> , modular terminal block with integrated surge protection, for mounting on NS 35				



Protective adapters for 5-wire remote bus output



Plug-in arrester with screw connection, for five conductors, with common reference potential



Plug-in arrester with screw connection, for five conductors, with common reference potential

Total width 25 mm

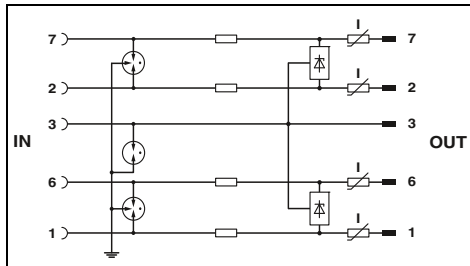

**Technical data**

B2 / C1 / C2 / C3 / D1  
 5.8 V DC / -  
 ≤ 180 mA (25°C)

≤ 5 kA / ≤ 5 kA  
 10 kA

≤ 20 V (C1 - 500 A) / ≤ 700 V (C1 - 500 A)

≥ 100 MHz  
 ≥ 100 MHz

25 mm / 110 mm / 63 mm  
 -40 °C ... 85 °C  
 IP20  
 -  
 D-SUB-9

DIN EN 61643-21 / IEC 61643-21

**Ordering data**

Type	Order No.	Pcs. / Pkt.
DT-UFB-IB-RB0	2800056	1

Total width 17.7 mm

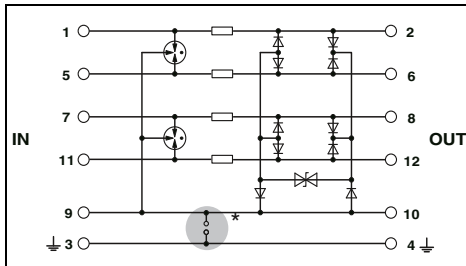

**Technical data**

C1 / C2 / C3 / D1  
 5.2 V DC / 3.6 V AC  
 450 mA (45°C)

10 kA / 10 kA  
 20 kA

≤ 34 V (C3 - 25 A) / ≤ 34 V (C3 - 25 A)

Typ. 70 MHz  
 -

17.7 mm / 90 mm / 65.5 mm  
 -40 °C ... 85 °C  
 IP20  
 V0  
 Screw connection (in connection with the base element)

IEC 61643-21/A1 / EN 61643-21/A1

**Ordering data**

Type	Order No.	Pcs. / Pkt.
PT 5-HF- 5 DC-ST	2838762	10
PT 2X2+F-BE	2839224	10
TT-SLKK5-F/110AC	2765602	50

Total width 17.7 mm

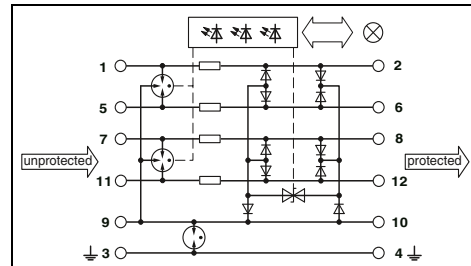

**Technical data**

C1 / C2 / C3 / D1  
 6 V DC / 4 V AC  
 600 mA (up to 40 °C)

10 kA / 10 kA  
 20 kA

≤ 30 V (C3 - 25 A) / ≤ 900 V (C3 - 25 A)

-  
 > 60 MHz

17.7 mm / 91 mm / 77.5 mm  
 -40 °C ... 70 °C  
 IP20  
 V0  
 Screw connection

EN 61643-21/A1 / IEC 61643-21/A2 / EN 61000-6-2/A1 /

**Ordering data**

Type	Order No.	Pcs. / Pkt.
PT-IQ-5-HF+F-5DC-UT	2800798	1

# Surge protection and interference filters

## Surge protection for information technology and telecommunications

### Surge protection for PROFIBUS

<b>Notes:</b>
For certifications, see page 154
Attenuation characteristics at <a href="http://www.phoenixcontact.net/products">www.phoenixcontact.net/products</a>



Plug-in arrester with screw connection, for five conductors, with common reference potential

Total width 17.7 mm

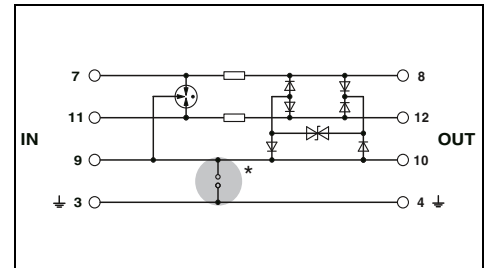

#### PT 3-PB

- Protection for two signal wires with common reference potential
- Data transmission rate up to 12 Mbps
- For INTERBUS/PROFIBUS systems
- For field multiplexers
- Connectors can be checked with CHECKMASTER

#### Pin assignment PT 3-PB:

- 7,11 data cable pair
- 9 Signal ground (Ground)

#### D-UFB-PB

- Direct use at the interface
- Data transmission rate up to 12 Mbps
- Integrated termination resistor

\* **Note:** PT .x.-BE connections 9/10 (GND) are linked directly to the mounting foot.

<b>Electrical data</b>	
IEC category / EN type	C1 / C2 / C3 / D1
Maximum continuous operating voltage $U_c$	5.2 V DC / 3.6 V AC
Nominal current $I_n$	450 mA (45°C)
Nominal discharge surge current $I_n$ (8/20) $\mu$ s	
Total surge current (8/20) $\mu$ s	Core-Core / Core-Ground 10 kA / 10 kA
Protection level $U_p$	Core-Core / Core-Ground 20 kA
Output voltage limitation at 1 kV/ $\mu$ s	Core-Core / Core-Ground $\leq 34$ V (C3 - 25 A) / $\leq 34$ V (C3 - 25 A)
Cut-off frequency $f_g$ (3 dB)	Core-Core / Core-Ground $\leq 15$ V / $\leq 15$ V
In a 100 $\Omega$ system	Symmetrical Typ. 70 MHz
<b>General data</b>	
Dimensions W / H / D	17.7 mm / 90 mm / 65.5 mm
Temperature range	-40 °C ... 85 °C
Degree of protection in acc. with IEC 60529/ EN 60529	IP20
Inflammability class in acc. with UL 94	V0
Connection method	Screw connection (in connection with the base element)
<b>Test standards</b>	
IEC 61643-21/A1 / EN 61643-21/A1	

#### Technical data

<b>Technical data</b>		
C1 / C2 / C3 / D1		
5.2 V DC / 3.6 V AC		
450 mA (45°C)		
Core-Core / Core-Ground 10 kA / 10 kA		
20 kA		
Core-Core / Core-Ground $\leq 34$ V (C3 - 25 A) / $\leq 34$ V (C3 - 25 A)		
Core-Core / Core-Ground $\leq 15$ V / $\leq 15$ V		
Symmetrical Typ. 70 MHz		
17.7 mm / 90 mm / 65.5 mm		
-40 °C ... 85 °C		
IP20		
V0		
Screw connection (in connection with the base element)		
IEC 61643-21/A1 / EN 61643-21/A1		

Description	Nominal voltage $U_N$
<b>PLUGTRAB connector</b> , with protective circuit for inserting in PT base element	5 V DC
<b>PLUGTRAB base element</b> , for mounting on NS 35	Bridge between 3/4 ( $\downarrow$ ) and 9/10
<b>DATATRAB</b> , Protective device for PROFIBUS-DP applications with up to 12 Mbps	

#### Ordering data

Type	Order No.	Pcs. / Pkt.
PT 3-PB-ST	2858030	10
PT 1X2-BE	2856113	10

<b>Shield fast connection</b>	
For $\varnothing$ 3-6 mm	
For $\varnothing$ 5-10 mm	
<b>Labeling material</b>	

#### Accessories

SSA 3-6	2839295	10
SSA 5-10	2839512	10
ZBF ..., see page 111		



Fine protection with 9-pos. D-SUB

Total width 44.5 mm

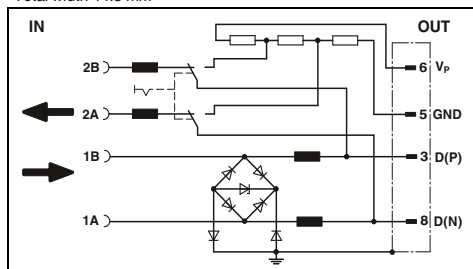

**Technical data**

C1 / C3 / B2  
5.2 V DC / -  
250 mA (25°C)

350 A / 350 A  
350 A

≤ 25 V (C1 (500 V/250 A)) / ≤ 25 V (C1 (500 V/250 A))

≤ 14 V / ≤ 14 V

Typ. 70 MHz

44.5 mm / 58 mm / 16.6 mm

-20 °C ... 75 °C

IP40

Screw connection & D-SUB-9

IEC 61643-21

**Ordering data**

Type	Order No.	Pcs. / Pkt.
D-UBB-PB	2880642	1

**Accessories**

--	--	--

# Surge protection and interference filters

## Surge protection for information technology and telecommunications

### For power supply and ISDN-S<sub>0</sub> interface

<b>Notes:</b>
For certifications, see page 154



For network and ISDN/RDSI systems/termination devices, with RJ45 connection

#### MNT-ISDN

- Compact protection for termination devices
- Easy operation
- Combined power supply and ISDN protection
- Connection to telecommunications socket using separate cable
- Thermal monitoring of the protective circuit
- Green LED - operating indicator for the power supply

#### DT-LAN-CAT.6+

- Protective adapter for eight signal paths via RJ45 connector
- Can be installed in a control cabinet by removing a ground connection adapter

#### WT-RJ 45-S/ISDN 1/K AP

- Surface-mounted socket
- With RJ45 socket as IAE
- Optimum in-house protection for sensitive interfaces

Total width 63 mm

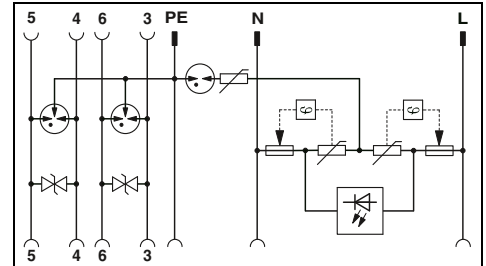

#### Technical data

Electrical data	Mains protection	Data protection
IEC category / EN type	III / T3	C2 / C3 / D1 / C1
Nominal voltage U <sub>N</sub>	230 V AC	-
Maximum continuous operating voltage U <sub>C</sub>	360 V AC (L/N-PE)	6 V DC
Nominal current I <sub>N</sub>	16 A (30 °C)	1.5 A (25 °C)
Nominal discharge surge current I <sub>n</sub> (8/20) μs		
	Core-Core / Core-Ground	3 kA / 3 kA
Combined surge U <sub>OC</sub>		4 kV
Protection level U <sub>p</sub>		
	Core-Core / Core-Ground	≤ 1.2 kV / ≤ 1.5 kV
Total surge current (8/20) μs		-
Output voltage limitation at 1 kV/μs		≤ 65 V (C1 - 1 kV/500 A) / ≤ 900 V (C2 - 4 kV/2 kA)
	Core-Core / Core-Ground	10 kA
Cut-off frequency f <sub>g</sub> (3 dB)		
In a 100 Ω system	Core-Core	-
		≤ 10 V / ≤ 900 V
<b>General data</b>		
Dimensions W / H / D	63 mm / 79 mm / 103.5 mm	
Temperature range	-25 °C ... 75 °C	
Degree of protection in acc. with IEC 60529/ EN 60529	IP20 (child-proof)	
Inflammability class in acc. with UL 94	V0/HB	
Connection method	RJ45	
Test standards	IEC 61643-1	IEC 61643-21

#### Ordering data

Description	Can be used as typical for the country	Type	Order No.	Pcs. / Pkt.
<b>MAINTRAB</b> , surge protection attachment plug for plugging into a socket for equipment and data interface protection, incl. 1.5 m coaxial cable.				
Black	D, A, NL	<b>MNT-ISDN D</b>	<b>2882336</b>	1
White	D, A, NL	<b>MNT-ISDN D/WH</b>	<b>2882349</b>	1
White	S, FIN, N	<b>MNT-ISDN S/WH</b>	<b>2880891</b>	1
<b>DATATRAB adapter</b> , protective adapters for inserting into the data line				
<b>WESTERNTRAB</b> , RJ45 outlet box, surface-type with surge protection for ISDN S <sub>0</sub> bus interface				

#### Accessories

<b>Patch cable</b> , CAT6, pre-assembled		
--	--	--





For LAN interfaces (Class E<sub>A</sub>/CAT 6) including PoE and ISDN S0 protection

Surface-mounted flush-type socket with RJ45 connection

Total width 25 mm

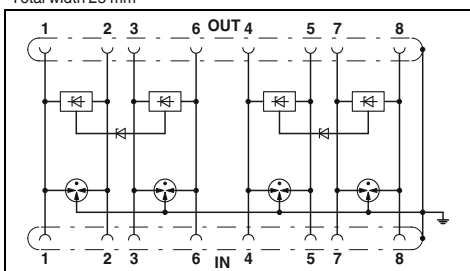

Total width 65 mm

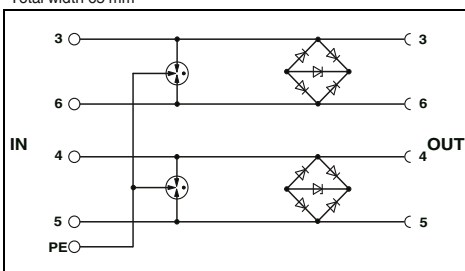

Technical data

B2 / C1 / C2 / C3 / D1  
-  
≤ 3.3 V DC (± 60 V DC/PoE+)  
≤ 1.5 A (25°C)

100 A / 2 kA (per signal pair)

≤ 9 V (B2 - 1 kV/25 A) / ≤ 700 V (C2 - 4 kV/2 kA)

10 kA

≤ 9 V / ≤ 700 V

> 500 MHz

25 mm / 103 mm / 63 mm

-40 °C ... 70 °C

IP20

-

RJ45

IEC 61643-21

Technical data

C2 / C3 / D1  
50 V DC (S<sub>0</sub> phantom power supply)  
6.2 V DC  
1.5 A (25°C)

350 A / 5 kA

≤ 70 V (C1 - 1 kV/500 A) / ≤ 460 V (C1 - 1 kV/500 A)

10 kA

≤ 12 V / ≤ 460 V

Typ. 80 MHz

65 mm / 30 mm / 80 mm

-40 °C ... 60 °C

IP20

-

Screw connection & RJ45

IEC 61643-21

Ordering data

Type	Order No.	Pcs. / Pkt.
DT-LAN-CAT.6+	2881007	1

Ordering data

Type	Order No.	Pcs. / Pkt.
WT-RJ 45-S/ISDN1/K AP	2809830	1

Accessories

FL CAT6 PATCH 1,5	2891482	10
-------------------	---------	----

Accessories

--	--	--

# Surge protection and interference filters

## Surge protection for information technology and telecommunications

### Surge protection for the ISDN-S<sub>0</sub> interface

#### COMTRAB modular

- Plug-in module
- Can be used in LSA-PLUS disconnect and control strips or CT-TERMIBLOCK
- High transmission bandwidth
- Use of two CTM ISDN for one ISDN connection
- Connectors can be checked with CHECKMASTER

Notes:
For certifications, see page 154
Attenuation characteristics at <a href="http://www.phoenixcontact.net/products">www.phoenixcontact.net/products</a>



For a double wire

Total width 9.5 mm

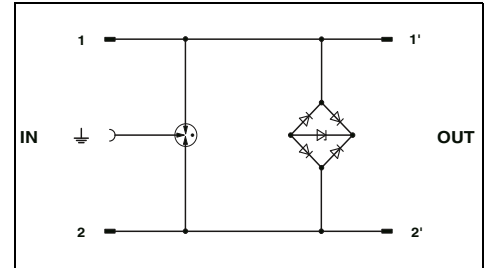

#### Technical data

Electrical data		
IEC category / EN type		B2 / C2 / C3 / D1 / C1
Maximum continuous operating voltage U <sub>c</sub>		± 6 V DC
Nominal current I <sub>N</sub>		1.5 A (25 °C)
Nominal discharge surge current I <sub>n</sub> (8/20) μs	Core-Core / Core-Ground	350 A / 5 kA
Total surge current (8/20) μs		10 kA
Protection level U <sub>p</sub>	Core-Core / Core-Ground	≤ 35 V (C1, 700 V/350 A) / ≤ 700 V (C3, 7.5 kV/100 A, spike)
Output voltage limitation at 1 kV/μs	Core-Core / Core-Ground	≤ 15 V / ≤ 700 V
Cut-off frequency f <sub>g</sub> (3 dB)		≥ 100 MHz
In a 100 Ω system	Symmetrical	
General data		
Dimensions W / H / D		9.5 mm / 21 mm / 53.5 mm
Temperature range		-25 °C ... 75 °C
Degree of protection in acc. with IEC 60529/ EN 60529		IP20
Inflammability class in acc. with UL 94		V0
Connection method		can be plugged into COMTRAB-TERMIBLOCK and LSA-PLUS disconnect and switching strips
Test standards		IEC 61643-21

#### Ordering data

Description	Type	Order No.	Pcs. / Pkt.
<b>COMTRAB modular</b> , surge protection for the ISDN S <sub>0</sub> interface	<b>CTM ISDN</b>	<b>2838555</b>	<b>10</b>

#### Accessories

<b>Magazine</b> , with grounding rail for accommodating up to 10 LSA-PLUS protective connectors (CTM...), for insertion in CT-TERMIBLOCK or LSA-PLUS disconnect strip	<b>CTM 10-MAG</b>	<b>2838610</b>	<b>5</b>
<b>Screw terminal block</b> , with disconnect contacts for accommodating the CT and CTM protective connectors, design: 10 double wires	<b>CT-TERMIBLOCK 10 DA</b>	<b>0441711</b>	<b>10</b>

**Surge protection for ISDN-U<sub>k0</sub> interfaces and T1/DS1 systems**

**PT 2-TELE**

- For ISDN U<sub>k0</sub> and DSL applications
- Broadband protection for telecommunications lines
- Connection: 7.11 for a/b wire pair

**D-DS1-A/RJ45-BB**

- For applications with T1 (DS1) or E1 data transmission protocol
- Connection via a keyed RJ45 (RJ48) female connector
- High transmission bandwidth



**Plug-in arrester with screw connection, for three conductors, with common reference potential**



**RJ45 attachment plug for two double wires**

**Notes:**  
 For certifications, see page 154  
 Attenuation characteristics at [www.phoenixcontact.net/products](http://www.phoenixcontact.net/products)

Total width 17.7 mm

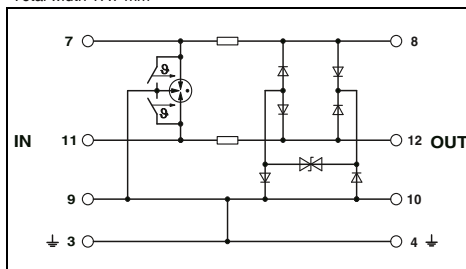

**Technical data**

<b>Electrical data</b>	
IEC category / EN type	C1 / C2 / C3 / D1 / B2
Maximum continuous operating voltage U <sub>c</sub>	185 V DC / 130 V AC
Nominal current I <sub>n</sub>	450 mA (45°C)
Nominal discharge surge current I <sub>n</sub> (8/20) μs	Core-Core / Core-Ground 10 kA / 10 kA
Total surge current (8/20) μs	20 kA
Protection level U <sub>p</sub>	Core-Core / Core-Ground ≤ 270 V (C1 - 1 kV/500 A) / ≤ 300 V (C2 - 2 kV / 1 kA)
Output voltage limitation at 1 kV/μs	Core-Core / Core-Ground ≤ 300 V / ≤ 300 V
Cut-off frequency f <sub>g</sub> (3 dB)	≥ 100 MHz
In a 100 Ω system	Symmetrical
<b>General data</b>	
Dimensions W / H / D	17.7 mm / 90 mm / 65.5 mm
Temperature range	-40 °C ... 85 °C
Degree of protection in acc. with IEC 60529/ EN 60529	IP20
Inflammability class in acc. with UL 94	V0
Connection method	Screw connection
Connection data solid / stranded / AWG	0.2 mm <sup>2</sup> - 4 mm <sup>2</sup> / 0.2 mm <sup>2</sup> - 2.5 mm <sup>2</sup> / 24 - 12
Test standards	IEC 61643-21 / DIN EN 61643-21

Total width 25.4 mm

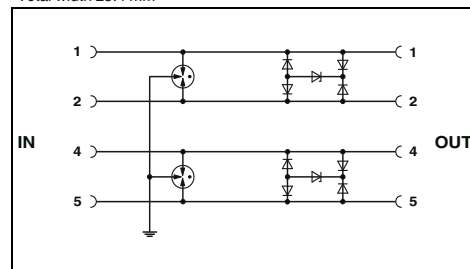

**Technical data**

<b>Electrical data</b>	
IEC category / EN type	C2 / C3 / D1
Maximum continuous operating voltage U <sub>c</sub>	7 V DC / -
Nominal current I <sub>n</sub>	1.5 A (25°C)
Nominal discharge surge current I <sub>n</sub> (8/20) μs	Core-Core / Core-Ground 350 A / 2.5 kA
Total surge current (8/20) μs	10 kA
Protection level U <sub>p</sub>	Core-Core / Core-Ground ≤ 50 V / ≤ 600 V
Output voltage limitation at 1 kV/μs	Core-Core / Core-Ground ≤ 20 V / ≤ 450 V
Cut-off frequency f <sub>g</sub> (3 dB)	≥ 100 MHz
In a 100 Ω system	Symmetrical
<b>General data</b>	
Dimensions W / H / D	25.4 mm / 25.4 mm / 102 mm
Temperature range	-40 °C ... 80 °C
Degree of protection in acc. with IEC 60529/ EN 60529	IP20
Inflammability class in acc. with UL 94	-
Connection method	RJ45
Connection data solid / stranded / AWG	-
Test standards	IEC 61643-21

**Ordering data**

Type	Order No.	Pcs. / Pkt.
PT 2-TELE	2882828	10

**Accessories**

PT 2-TELE-ST	2838733	10
--------------	---------	----

**Ordering data**

Type	Order No.	Pcs. / Pkt.
D-DS1-A/RJ45-BB	2838050	1

**Accessories**

FL CAT6 PATCH 1,0	2891385	10
-------------------	---------	----

<b>DATA-PLUGTRAB</b> , consisting of plug and base element
<b>DATATRAB</b> , attachment connector with surge protection for T1/E1 systems.

<b>Replacement plug</b>
Patch cable, CAT6, pre-assembled

**Labeling material**

ZBF ... see page 111

# Surge protection and interference filters

## Surge protection for information technology and telecommunications

### For analog and DSL telecommunications systems

#### MNT ...

- Compact protection for termination devices
- Easy operation
- Thermal monitoring of the protective circuit
- Green LED - operating indicator for the power supply
- MNT-TAE, with TAE connection for DSL (ADSL2+) and in the ISDN network before the NTBA
- MNT-TELE, with RJ12/RJ45 sockets, for telephone, modem, and answering machine with a max. operating voltage of 185 V

#### TAE-TRAB FM-NFN

- For surface mounting
- Three TAE6 slots
- For two N-encoded and one F-encoded termination device
- Suitable for DSL (ADSL2+)
- Main areas of application: phone terminals, answering machines, modems, and fax machines

#### WT-RJ12

- Surface-mounted socket
- With 6-pos. RJ12 Western socket
- Also accommodates RJ11 plug
- Angled RJ12 take-up

<b>Notes:</b>
For certifications, see page 154
Attenuation characteristics at <a href="http://www.phoenixcontact.net/products">www.phoenixcontact.net/products</a>



### For telecommunications systems with TAE connection

Total width 63 mm

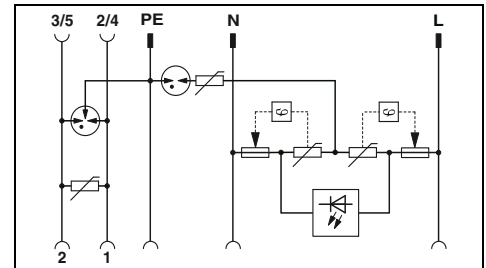

#### Technical data

Electrical data	Mains protection	Data protection
IEC category / EN type	III / T3	C1 / C2 / C3 / D1
Nominal voltage $U_N$	230 V AC	-
Maximum continuous operating voltage $U_C$	360 V AC (L/N-PE)	200 V DC
Nominal current $I_N$	16 A (30 °C)	1.5 A (25 °C)
Nominal discharge surge current $I_n$ (8/20) $\mu$ s		
	Core-Core / Core-Ground	3 kA / 3 kA
Combined surge $U_{OC}$		4 kV
Protection level $U_p$		
	Core-Core / Core-Ground	$\leq 1.2$ kV / $\leq 1.5$ kV
Total surge current (8/20) $\mu$ s	-	$\leq 460$ V (C2 - 1 kA) / $\leq 900$ V (C2 - 2 kA)
Output voltage limitation at 1 kV/ $\mu$ s	-	5 kA
	Core-Core / Core-Ground	- / -
Core-Core / Core-Ground	- / -	$\leq 360$ V / -
Cut-off frequency $f_g$ (3 dB)		
In a 600 $\Omega$ system	Core-Core	-
<b>General data</b>		
Dimensions W / H / D	63 mm / 79 mm / 103.5 mm	
Temperature range	-25 °C ... 75 °C	
Degree of protection in acc. with IEC 60529/ EN 60529	IP20 (child-proof)	
Inflammability class in acc. with UL 94	V0/HB	
Connection method	RJ12/TAE 6	
Test standards	IEC 61643-1	IEC 61643-21

#### Ordering data

Description	Can be used as typical for the country	Type	Order No.	Pcs. / Pkt.
<b>MAINTRAB</b> , combination surge protection adapter for plugging into a socket, for equipment and TAE protection				
Black	D	<b>MNT-TAE D</b>	<b>2882381</b>	1
White	D	<b>MNT-TAE D/WH</b>	<b>2882394</b>	1
<b>TAE outlet box (NFN)</b> with surge protection for analog telecommunications interfaces				
Surface-mounted socket	D			
<b>MAINTRAB</b> , combined surge protection adapter for plugging into a socket, for device and TEL/TELE protection.				
Black	B, F, CZ, SVK, PL			
Black	E, P, I, NL, LUX			
White	S, FIN			
White	N			
<b>WESTERNTRAB</b> , RJ12 connection socket with surge protection for analog telecommunication interfaces				
Surface-mounted socket, 1 socket				



TAE outlet box (NFN)



For telecommunications systems with RJ12/RJ45 connection



Surface-mounted socket with RJ12 connection

Total width 65 mm

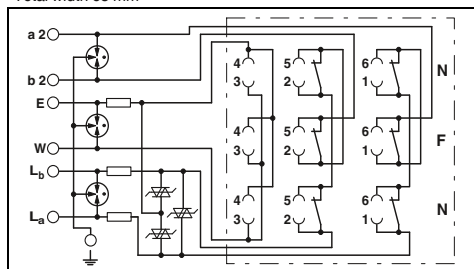

### Technical data

B2 / C1 / C2 / C3 / D1  
60 V DC  
185 V DC  
450 mA ( $\leq 40^\circ\text{C}$ )

5 kA / 5 kA  
-

$\leq 250 \text{ V (C2 - 10 kV / 5 kA) / } \leq 500 \text{ V (C2 - 10 kV / 5 kA)}$

10 kA

$\leq 250 \text{ V / } \leq 450 \text{ V}$

Typ. 2 MHz

65 mm / 27 mm / 80 mm  
-40 °C ... 80 °C  
IP20  
-

Screw connection & TAE 6  
DIN EN 61643-21

### Ordering data

Type	Order No.	Pcs. / Pkt.
TAE-TRAB FM-NFN-AP	2749628	1

Total width 63 mm

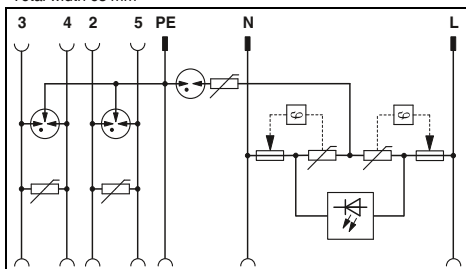

### Technical data

Mains protection	Data protection
III / T3	C1 / C2 / C3 / D1
230 V AC	-
360 V AC (L/N-PE)	200 V DC
16 A (30 °C)	1.5 A (25°C)
3 kA / 3 kA	1 kA / 2.5 kA
4 kV	-
$\leq 1.2 \text{ kV / } \leq 1.5 \text{ kV}$	$\leq 460 \text{ V (C2 - 1 kA) / } \leq 900 \text{ V (C2 - 2 kA)}$
-	10 kA
- / -	$\leq 360 \text{ V / -}$
-	-

63 mm / 79 mm / 103.5 mm  
-25 °C ... 75 °C  
IP20 (child-proof)  
V0/HB  
RJ12

EN 61643-11/A11      EN 61643-11/A11

### Ordering data

Type	Order No.	Pcs. / Pkt.
MNT-TEL B/F	2882404	1
MNT-TELE E	2882417	1
MNT-TELE S/WH	2880901	1
MNT-TELE N/WH	2881764	1

Total width 65 mm

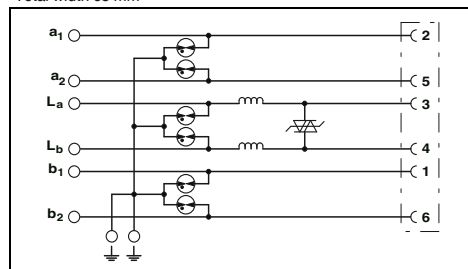

### Technical data

C1 / C2 / C3 / D1  
-

185 V DC  
150 mA (25°C)

2.5 kA / 2.5 kA  
-

$\leq 240 \text{ V / } \leq 700 \text{ V}$

10 kA

$\leq 220 \text{ V / } \leq 700 \text{ V}$

Typ. 1.7 MHz

65 mm / 39 mm / 80 mm  
-40 °C ... 80 °C  
IP20  
-

Screw connection & RJ12  
IEC 61643-21

### Ordering data

Type	Order No.	Pcs. / Pkt.
WT-RJ 12-S/FM A/K AP	2809186	1

# Surge protection and interference filters

## Surge protection for information technology and telecommunications

### Surge protection for analog and DSL telecommunication systems

#### PT 2-TELE

- For analog telecommunications
- Two-piece, plug-in
- Universal use
- High discharge capacity
- Connectors can be checked with CHECKMASTER

#### DT-TELE-RJ45

- For analog and digital (DSL) telecommunications interface
- Connection: RJ45 socket and/or plug-in screw terminal blocks
- The adapter included enables conversion from RJ45 to RJ11 and RJ12 (for contacting, see circuit diagram)
- International use thanks to multiple assignment
- DIN rail mounting possible by removing the cap

#### CTM...

- For analog telecommunications
- Plug-in module
- Can be used in LSA-PLUS disconnect/control strips or CT-TERMIBLOCK
- Connectors can be checked with CHECKMASTER

<b>Notes:</b>
For certifications, see page 154
Attenuation characteristics at <a href="http://www.phoenixcontact.net/products">www.phoenixcontact.net/products</a>



Plug-in arrester with screw connection, for three conductors, with common reference potential

Total width 17.7 mm

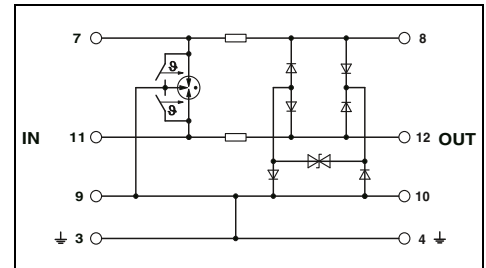

#### Technical data

<b>Electrical data</b>		
IEC category / EN type		C1 / C2 / C3 / D1 / B2
Maximum continuous operating voltage $U_c$		185 V DC / 130 V AC
Nominal current $I_n$		450 mA (45°C)
Nominal discharge surge current $I_n$ (8/20) $\mu$ s		
	Core-Core / Core-Ground	10 kA / 10 kA
Total surge current (8/20) $\mu$ s		20 kA
Output voltage limitation at 1 kV/ $\mu$ s		
	Core-Core / Core-Ground	$\leq 300$ V / $\leq 300$ V
Cut-off frequency fg (3 dB)		Typ. 20 MHz / -
In a 100 $\Omega$ system	Symmetrical / Asymmetrical	
<b>General data</b>		
Dimensions W / H / D		17.7 mm / 90 mm / 65.5 mm
Temperature range		-40 °C ... 85 °C
Degree of protection in acc. with IEC 60529/ EN 60529		IP20
Inflammability class in acc. with UL 94		V0
Connection method		Screw connection
Connection data solid / stranded / AWG		0.2 mm <sup>2</sup> - 4 mm <sup>2</sup> / 0.2 mm <sup>2</sup> - 2.5 mm <sup>2</sup> / 24 - 12
Test standards		IEC 61643-21 / DIN EN 61643-21

#### Ordering data

Type	Order No.	Pcs. / Pkt.
PT 2-TELE	2882828	10

#### Accessories

PT 2-TELE-ST	2838733	10
--------------	---------	----

<b>Description</b>
<b>DATA-PLUGTRAB</b> , consisting of plug and base element
<b>DATATRAB</b> , surge protection for two signal pairs of the analog and digital (DSL) telecommunication interface
<b>COMTRAB modular</b>
<b>Replacement connector</b>
<b>Magazine</b> , with grounding rail for accommodating up to 10 LSA-PLUS protective connectors (CTM...), for insertion in CT-TERMIBLOCK or LSA-PLUS disconnect strip
<b>Screw terminal block</b> , with disconnect contacts for accommodating the CT and CTM protective connectors, design: 10 double wires
<b>Labeling material</b>

ZBF ..., see page 111



RJ45 attachment plug for two double wires



2-wire coarse protection, with failsafe contact



Double wire (loop), floating

Total width 25 mm

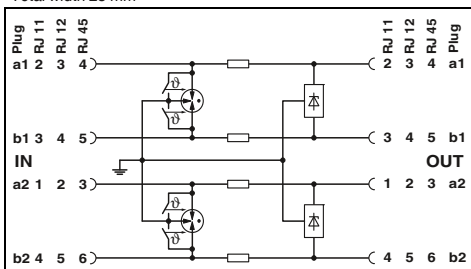

### Technical data

B2 / C1 / C2 / C3 / D1  
185 V DC / 130 V AC  
≤ 380 mA (25°C)

≤ 5 kA / ≤ 5 kA  
10 kA

≤ 250 V / ≤ 250 V

Typ. 50 MHz / -

25 mm / 103 mm / 63 mm

-40 °C ... 85 °C

IP20

-  
RJ45 / Combicon

-  
IEC 61643-21

### Ordering data

Type	Order No.	Pcs. / Pkt.
DT-TELE-RJ45	2882925	1

### Accessories

Total width 9.5 mm

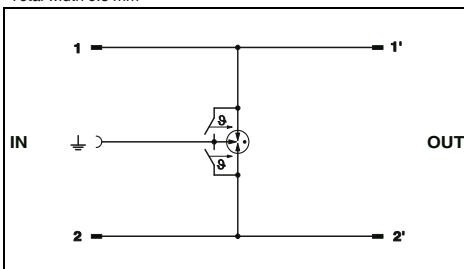

### Technical data

A2 / B1 / B2 / B3 / C1 / C2 / C3 / D1 / D2  
± 180 V DC / -  
1.5 A (25°C)

- / 5 kA  
10 kA

- / ≤ 800 V

- / > 100 MHz

9.5 mm / 21 mm / 53.5 mm

-40 °C ... 85 °C

IP20

V0

can be plugged into COMTRAB-TERMIBLOCK and LSA-PLUS disconnect and switching strips

-  
IEC 61643-21

### Ordering data

Type	Order No.	Pcs. / Pkt.
CTM 2X1-180DC-GS	2838636	10

### Accessories

CTM 10-MAG	2838610	5
CT-TERMIBLOCK 10 DA	0441711	10

Total width 9.5 mm

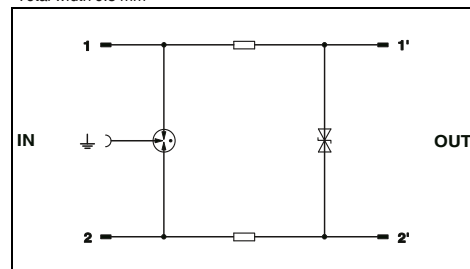

### Technical data

B2 / C1 / C2 / C3 / D1  
± 180 V DC / -  
380 mA (25°C)

5 kA / 5 kA  
10 kA

≤ 260 V / ≤ 800 V

20 MHz / -

9.5 mm / 21 mm / 53.5 mm

-25 °C ... 75 °C

IP20

V0

can be plugged into COMTRAB-TERMIBLOCK and LSA-PLUS disconnect and switching strips

-  
IEC 61643-21

### Ordering data

Type	Order No.	Pcs. / Pkt.
CTM 1X2-110AC	2838539	10

### Accessories

CTM 10-MAG	2838610	5
CT-TERMIBLOCK 10 DA	0441711	10



#### **You won't lose reception with COAX-TRAB**

Transceiver systems are generally considered to be particularly susceptible to surge voltages. Antenna cables which extend beyond a building and are usually very long, plus the antennas themselves, are directly exposed to atmospheric discharge.

Cables with a coaxial structure and therefore favorable EMC properties are primarily used in antenna systems. However, the risk of surge voltage coupling in antenna cables and potential transfer through to the sensitive interfaces of transceiver systems is not eliminated.

Thanks to interface-optimized surge protective devices, the COAXTRAB product range significantly increases safety for transceiver equipment. The aim of such safety measures is to increase the availability and operability of the devices affected.





### Shielding

Good shielding properties are vital for a clean transmission. The rugged metal housings provide ideal shielding properties and are also suitable for use in harsh industrial environments.

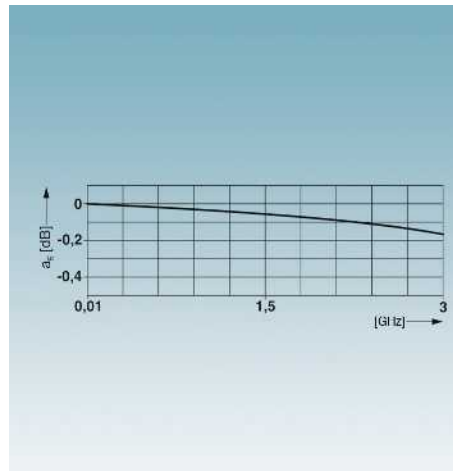

### Customized products

Appropriate protective devices are available for all applications including SAT receiver systems, mobile phones, and video monitoring.

The very low attenuation values ensure that data transmission is clean.



### Performance classes

The protective devices conform to standards in all performance classes. This applies for coarse protection in accordance with Category D1, 10/350  $\mu$ s and for fine protection in accordance with Category C1, 8/20  $\mu$ s.



### Connection technology

The right connection technology to suit the application: F connector, TV connector, type N, 7/16, UHF, BNC, SMA.

# Surge protection and interference filters

## Surge protection for transceiver systems

### Protective adapters with coaxial connection **COAXTRAB**

- For antennas with N and BNC connection
- High transmission capacities even for frequencies up to 6 GHz
- Mounting plate enables fixed mounting, e.g., in a control cabinet
- The protective adapters can also be used in a 75 Ω system with 50 Ω BNC connectors

Notes:
For certifications, see page 154
Attenuation characteristics at <a href="http://www.phoenixcontact.net/products">www.phoenixcontact.net/products</a>



For GSM systems (3 GHz), grounded shield, connection: N type

Total width 31 mm

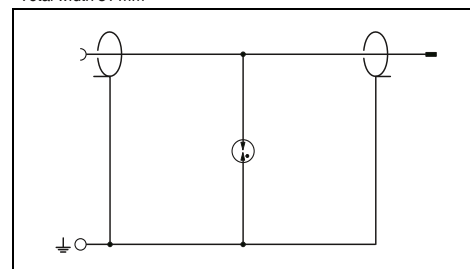

Electrical data	
IEC category / EN type	C2 / C3 / D1
Maximum continuous operating voltage $U_c$	280 V DC / -
Nominal current $I_n$	5 A (25°C)
Nominal discharge surge current $I_n$ (8/20) μs	20 kA / 20 kA
Total surge current (8/20) μs	20 kA
Protection level $U_p$	≤ 900 V (C1 - 1 kV/500 A) / ≤ 900 V (C1 - 1 kV/500 A)
Frequency range	0 Hz ... 3 GHz
Standing wave ratio SWR in a 50 Ω system	Typ. 1.15 (≤ 3 GHz)
Permissible RF power $P_{max}$	700 W (VSWR = 1.1)
General data	
Dimensions W / H / D	31 mm / 57.8 mm / 33.5 mm
Temperature range	-40 °C ... 80 °C
Degree of protection in acc. with IEC 60529/ EN 60529	IP55
Connection method	N connector 50 Ω
Test standards	IEC 61643-21/A1 / EN 61643-21/A1

### Technical data

C2 / C3 / D1		
280 V DC / -		
5 A (25°C)		
Core-Shield / Core-Ground	20 kA / 20 kA	
Core-Shield / Core-Ground	20 kA	
Core-Shield / Core-Ground	≤ 900 V (C1 - 1 kV/500 A) / ≤ 900 V (C1 - 1 kV/500 A)	
0 Hz ... 3 GHz		
Typ. 1.15 (≤ 3 GHz)		
700 W (VSWR = 1.1)		
31 mm / 57.8 mm / 33.5 mm		
-40 °C ... 80 °C		
IP55		
N connector 50 Ω		
IEC 61643-21/A1 / EN 61643-21/A1		

Description
<b>COAXTRAB</b> , protective adapter for antenna connections
Female/female
Male/female

### Ordering data

Type	Order No.	Pcs. / Pkt.
<b>CN-UB-280DC-3-BB</b>	2801050	1
<b>CN-UB-280DC-3-SB</b>	2801051	1

Mounting plate, for individual attachment to housing panels	
straight	
angled	
<b>BNC connector</b> , single-level, for mounting on NS 32 or NS 35/7.5	
50 Ω wave impedance	
<b>Adapter</b> , insertion loss <0.3 dB at 2.4 GHz	
N (male) -> SMA (female)	
<b>Adapter cable</b> , pigtail, insertion loss 1.5 dB at 2.4 GHz; impedance 50 Ω;	
50 cm long, MCX (male) -> N (male)	

### Accessories

<b>CN-UB/MP</b>	2818135	10
<b>CN-UB/MP-90DEG-50</b>	2803137	1



With N connector (0 - 6 GHz), grounded shield



With N connector, floating shield



With BNC connector, floating shield

Total width 24 mm

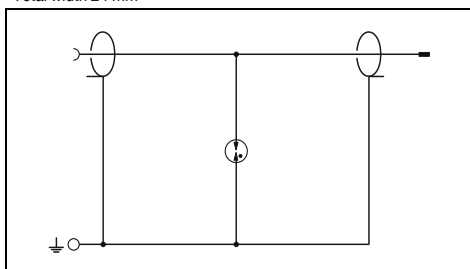

### Technical data

C2 / C3 / D1  
70 V DC / 50 V AC  
10 A

5 kA / 5 kA  
5 kA

- / ≤ 800 V (C2 (4 kV/2 kA))

0 Hz ... 6 GHz  
Typ. 1.15 (6 GHz)  
30 W (VSWR = 1.15)

24 mm / 24 mm / 50 mm  
-40 °C ... 90 °C  
IP68  
N connector 50 Ω  
IEC 61643-21

Total width 25.4 mm

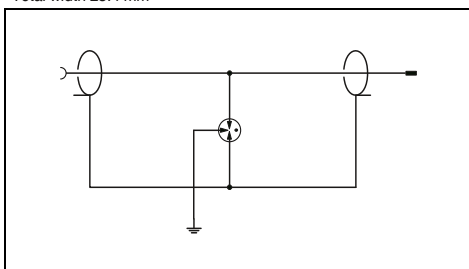

### Technical data

C2 / C3 / D1  
180 V DC / 130 V AC  
5 A (25°C)

5 kA / 5 kA  
10 kA

- / ≤ 500 V (C2, 10 kV/5 kA)

-  
≤ 1.2 (≤ 200 MHz)  
300 W (VSWR = 1.1)

25.4 mm / 83 mm / 25.4 mm  
-40 °C ... 80 °C  
IP20  
N connector 50 Ω  
-

Total width 25.4 mm

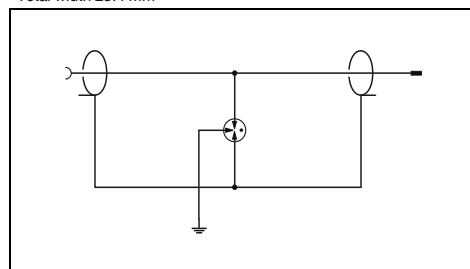

### Technical data

C2 / C3 / D1  
180 V DC / 130 V AC  
3.5 A (25°C)

5 kA / 5 kA  
10 kA

- / ≤ 500 V (C2 - 10 kV / 5 kA)

-  
Typ. 1.3 (≤ 150 MHz)  
300 W (VSWR = 1.1)

25.4 mm / 2.54 mm / 80 mm  
-40 °C ... 80 °C  
IP20  
BNC 50 Ω  
IEC 61643-21 / DIN EN 61643-21

### Ordering data

Type	Order No.	Pcs. / Pkt.
CN-UB-70DC-6-BB	2803166	1
CN-UB-70DC-6-SB	2803153	1

### Accessories

CN-UB/MP	2818135	10
CN-UB/MP-90DEG-50	2803137	1
RAD-ADP-N/M-SMA/F	2917036	1
RAD-PIG-EF316-MCX-N	2867681	1

### Ordering data

Type	Order No.	Pcs. / Pkt.
CN-UB/E-BB	2817686	1
CN-UB/E	2763691	1

### Accessories

BNC-V 50	2805041	10
----------	---------	----

### Ordering data

Type	Order No.	Pcs. / Pkt.
C-UB/E	2763701	10

### Accessories

BNC-V 50	2805041	10
----------	---------	----

# Surge protection and interference filters

## Surge protection for transceiver systems

### Protection for mobile phone antennas

- For antennas with N, 7/16, and SMA connection
- High transmission capacities even for frequencies up to 6 GHz
- Maintenance-free surge protection with Lambda/4 technology
- Low protection level

<b>Notes:</b>
For certifications, see page 154
Attenuation characteristics at <a href="http://www.phoenixcontact.net/products">www.phoenixcontact.net/products</a>



For TETRA systems (380 MHz - 470 MHz), grounded shield



For GSM systems (0.8 GHz-2.25 GHz), grounded shield, connection: N type

Total width 32 mm

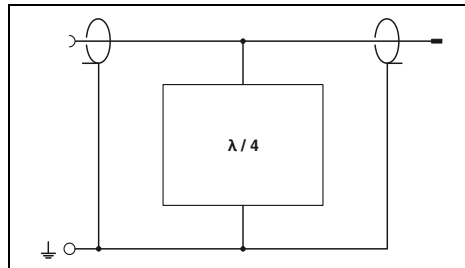

#### Technical data

Electrical data	
IEC category / EN type	C2 / C3 / D1
Nominal current $I_N$	5 A (25 °C)
Nominal discharge surge current $I_n$ (8/20) $\mu$ s	20 kA / 20 kA
Total surge current (8/20) $\mu$ s	30 kA
Protection level $U_p$	$\leq 95$ V (C2 - 10 kV / 5 kA) / $\leq 95$ V (C2 - 10 kV / 5 kA)
Frequency range	380 MHz ... 470 MHz
Standing wave ratio SWR in a 50 $\Omega$ system	Typ. 1.05 ( $\leq 1,15$ )
Permissible. RF power $P_{max}$	$\leq 800$ W
General data	
Dimensions W / H / D	32 mm / 32 mm / 83 mm
Temperature range	-40 °C ... 90 °C
Degree of protection in acc. with IEC 60529/ EN 60529	IP68
Connection method	N connector
Test standards	IEC 61643-21

Total width 25 mm

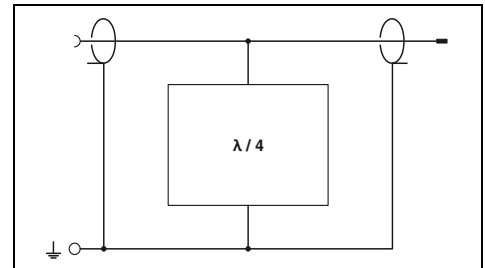

#### Technical data

Electrical data	
IEC category / EN type	C2 / C3 / D1
Nominal current $I_N$	5 A (25 °C)
Nominal discharge surge current $I_n$ (8/20) $\mu$ s	50 kA / 50 kA
Total surge current (8/20) $\mu$ s	60 kA
Protection level $U_p$	- / $\leq 5$ V (C1 - 1 kV/500 A)
Frequency range	0.8 GHz ... 2.25 GHz
Standing wave ratio SWR in a 50 $\Omega$ system	Typ. 1.2
Permissible. RF power $P_{max}$	$\leq 500$ W
General data	
Dimensions W / H / D	25 mm / 78.7 mm / 77.5 mm
Temperature range	-40 °C ... 85 °C
Degree of protection in acc. with IEC 60529/ EN 60529	IP68
Connection method	N connector 50 $\Omega$
Test standards	IEC 61643-21/A1 / EN 61643-21/A1

#### Ordering data

Description	
COAXTRAB, protective adapter for antenna connections with Lambda/4 technology	
Female/female	CN-LAMBDA/4-0.47-BB
Male/female	CN-LAMBDA/4-0.47-SB
Surge protection for UMTS and quad-band GSM antenna, with SMA connector and SMA coupling	

Type	Order No.	Pcs. / Pkt.
CN-LAMBDA/4-0.47-BB	2800021	1
CN-LAMBDA/4-0.47-SB	2800022	1

#### Ordering data

Type	Order No.	Pcs. / Pkt.
CN-LAMBDA/4-2.25-BB	2801057	1
CN-LAMBDA/4-2.25-SB	2801056	1

#### Accessories

Mounting plate, for individual attachment to housing panels	
straight	CN-UB/MP-90DEG-50
angled	CN-UB/MP-90DEG-50
Adapter, insertion loss <0.3 dB at 2.4 GHz	
N (male) -> SMA (female)	RAD-ADP-N/M-SMA/F
Adapter cable, pigtail, insertion loss 1.5 dB at 2.4 GHz; impedance 50 $\Omega$ ;	
50 cm long, MCX (male) -> N (male)	RAD-PIG-EF316-MCX-N

Type	Order No.	Pcs. / Pkt.
CN-UB/MP-90DEG-50	2803137	1
RAD-ADP-N/M-SMA/F	2917036	1
RAD-PIG-EF316-MCX-N	2867681	1

#### Accessories

Type	Order No.	Pcs. / Pkt.
CN-UB/MP	2818135	10
CN-UB/MP-90DEG-50	2803137	1



For GSM systems (0.8 GHz-2.25 GHz), grounded shield, connection: 7/16



Protective adapter set with SMA connection, grounded shield



For GSM and WiMAX systems (2.4 GHz - 5.9 GHz), grounded shield

Total width 39 mm

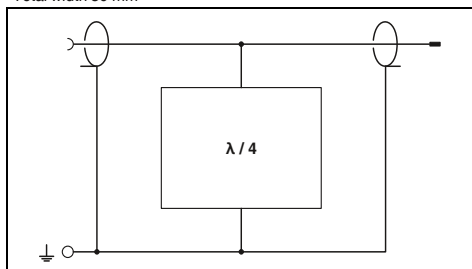

### Technical data

C2 / C3 / D1  
5 A (25 °C)  
  
50 kA / 50 kA  
60 kA  
  
- / ≤ 5 V (C1 - 1 kV/500 A)  
  
0.8 GHz ... 2.25 GHz  
Typ. 1.2  
≤ 500 W

39 mm / 83.5 mm / 82 mm  
-40 °C ... 85 °C  
IP68  
7/16 connector  
IEC 61643-21/A1 / EN 61643-21/A1

### Ordering data

Type	Order No.	Pcs. / Pkt.
C7/16-LAMBDA/4-2.25-BB	2801060	1
C7/16-LAMBDA/4-2.25-SB	2801059	1

### Accessories

Type	Order No.	Pcs. / Pkt.
CN-UB/MP	2818135	10
CN-UB/MP-90DEG-50	2803137	1

Total width 46.5 mm

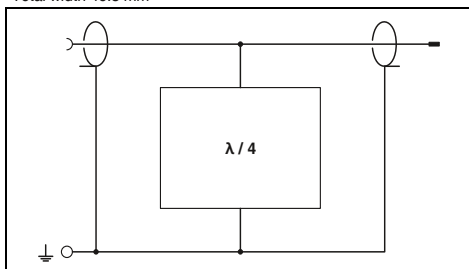

### Technical data

C2 / C3 / D1  
2 A (25 °C)  
  
6 kA / 6 kA  
6 kA  
  
- / ≤ 5 V (C1 (1 kV/500 A))  
  
0.8 GHz ... 2.25 GHz  
≤ 1.2 (0.8 GHz ... 2.25 GHz)  
≤ 110 W (VSWR = 1.0)

46.5 mm / 25 mm / 70 mm  
-40 °C ... 70 °C  
IP55  
SMA connector  
IEC 61643-21/A1 / EN 61643-21/A1

### Ordering data

Type	Order No.	Pcs. / Pkt.
CSMA-LAMBDA/4-2.0-BS-SET	2800491	1

### Accessories

Type	Order No.	Pcs. / Pkt.
CN-UB/MP	2818135	10
CN-UB/MP-90DEG-50	2803137	1

Total width 26.1 mm

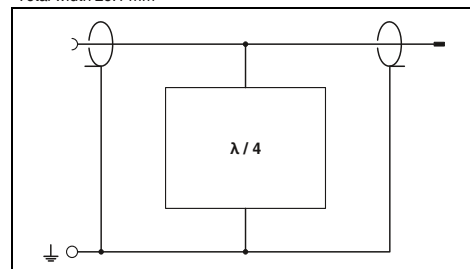

### Technical data

C2 / C3 / D1  
5 A (25 °C)  
  
50 kA / 50 kA  
60 kA  
  
- / ≤ 11 V (6 kV/3 kA)  
  
2.4 GHz ... 5.9 GHz  
Typ. 1.1 (≤ 1.20 (2.4 GHz...5.9 GHz))  
≤ 500 W

26.1 mm / 38 mm / 60 mm  
-40 °C ... 90 °C  
IP68  
N connector  
IEC 61643-21

### Ordering data

Type	Order No.	Pcs. / Pkt.
CN-LAMBDA/4-5.9-BB	2838490	1
CN-LAMBDA/4-5.9-SB	2800023	1

### Accessories

Type	Order No.	Pcs. / Pkt.
CN-UB/MP-90DEG-50	2803137	1
RAD-ADP-N/M-SMA/F	2917036	1
RAD-PIG-EF316-MCX-N	2867681	1

# Surge protection and interference filters

## Surge protection for transceiver systems

### Protective adapters with BNC connection COAXTRAB

- For insertion in the cable
- Ground connection via separately led cable

<b>Notes:</b>
For certifications, see page 154
Attenuation characteristics at <a href="http://www.phoenixcontact.net/products">www.phoenixcontact.net/products</a>



For floating communication systems



For non-floating communication systems

Total width 25.4 mm

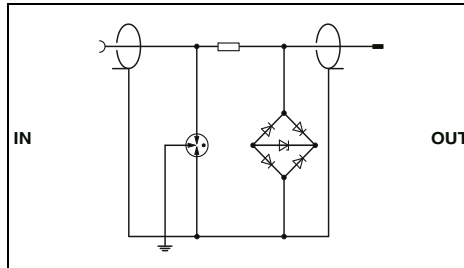

Total width 25.4 mm

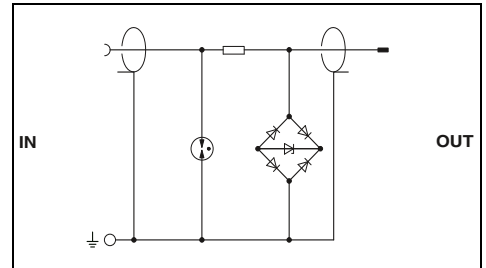

<b>Electrical data</b>	
IEC category / EN type	... 5DC/E ... 24DC/E ... 5DC/E 75
Maximum continuous operating voltage $U_C$	C2 / C3 / D1 C2 / C3 / D1 C2 / C3 / D1
Nominal current $I_N$	5 V DC 30 V DC 5 V DC
Nominal discharge surge current $I_n$ (8/20) $\mu$ s	185 mA (25°C) 185 mA (25°C) -
Total surge current (8/20) $\mu$ s	Core-Shield / Core-Ground 10 kA / 10 kA 10 kA / 10 kA 10 kA / 10 kA
Output voltage limitation at 1 kV/ $\mu$ s	20 kA 20 kA 20 kA
Cut-off frequency $f_g$ (3 dB)	Core-Shield / Core-Ground $\leq 15$ V / - $\leq 45$ V / - $\leq 15$ V / -
In a 50 $\Omega$ system	Asymmetrical Typ. 90 MHz Typ. 90 MHz Typ. 80 MHz
<b>General data</b>	
Temperature range	-40 °C ... 80 °C
Degree of protection in acc. with IEC 60529/ EN 60529	IP20
Connection method	BNC 50 $\Omega$ BNC 50 $\Omega$ BNC 75 $\Omega$
Test standards	IEC 61643-21

<b>Technical data</b>	
... 5DC	... 24DC
C2 / C3 / D1	C2 / C3 / D1
5 V DC	30 V DC
185 mA (25°C)	185 mA (25°C)
10 kA / 10 kA	10 kA / 10 kA
10 kA	10 kA
$\leq 15$ V / $\leq 15$ V	$\leq 45$ V / $\leq 45$ V
Typ. 90 MHz	Typ. 90 MHz
<b>General data</b>	
-40 °C ... 80 °C	
IP20	
BNC 50 $\Omega$	BNC 50 $\Omega$
IEC 61643-21	

<b>Technical data</b>	
... 5DC	... 24DC
C2 / C3 / D1	C2 / C3 / D1
5 V DC	30 V DC
185 mA (25°C)	185 mA (25°C)
10 kA / 10 kA	10 kA / 10 kA
10 kA	10 kA
$\leq 15$ V / $\leq 15$ V	$\leq 45$ V / $\leq 45$ V
Typ. 90 MHz	Typ. 90 MHz
<b>General data</b>	
-40 °C ... 80 °C	
IP20	
BNC 50 $\Omega$	BNC 50 $\Omega$
IEC 61643-21	

<b>Ordering data</b>	
Description	Type
COAXTRAB, as surge protection for coaxial cables, connection via plug and socket	
BNC 50 $\Omega$	C-UFB- 5DC/E
BNC 50 $\Omega$	C-UFB-24DC/E
BNC 75 $\Omega$	C-UFB- 5DC/E 75

<b>Ordering data</b>	
Type	Order No.
C-UFB- 5DC/E	2782300
C-UFB-24DC/E	2782313
C-UFB- 5DC/E 75	2763604

<b>Ordering data</b>	
Type	Order No.
C-UFB- 5DC	2797858
C-UFB-24DC	2797861

<b>Accessories</b>	
BNC connector, single-level, for mounting on NS 32 or NS 35/7.5	BNC-V 50
50 $\Omega$ wave impedance	2805041
75 $\Omega$ wave impedance	BNC-V 75
BNC connector, double-level, for mounting on NS 32 or NS 35/7.5	BNC-DV 50
50 $\Omega$ wave impedance	2805038
75 $\Omega$ wave impedance	BNC-DV 75
	2805083

<b>Accessories</b>	
BNC-V 50	2805041
BNC-DV 50	2805038
BNC-DV 75	2805083

<b>Accessories</b>	
BNC-V 50	2805041
BNC-DV 50	2805038

**BNC connectors**

- For coaxial cables
- DIN rail-mountable and can be aligned
- Single or double-level
- Can be labeled individually
- With isolated structure on the DIN rail



**BNC connector, single-level**



**BNC connector, double-level**

Total width 22 mm

**Technical data**

General data	BNC-V 50	BNC-V 75
Temperature range	125 °C	
Degree of protection in acc. with IEC 60529/ EN 60529	IP20	
Connection method	BNC 50 Ω	BNC 75 Ω

**Ordering data**

Description	Type	Order No.	Pcs. / Pkt.	
<b>BNC connector</b> , single-level, for mounting on NS 32 or NS 35/7.5	50 Ω wave impedance	<b>BNC-V 50</b>	2805041	10
	75 Ω wave impedance	<b>BNC-V 75</b>	2805070	10
<b>BNC connector</b> , double-level, for mounting on NS 32 or NS 35/7.5	50 Ω wave impedance			
	75 Ω wave impedance			

**Accessories**

<b>Terminal marking</b> , can be labeled according to customer specifications			
4-section	<b>ZB 22 CUS</b>	0824949	1

Total width 22 mm

**Technical data**

BNC-DV 50	BNC-DV 75
125 °C	
IP20	
BNC 50 Ω	BNC 75 Ω

**Ordering data**

Type	Order No.	Pcs. / Pkt.
<b>BNC-DV 50</b>	2805038	10
	2805083	10
<b>BNC-DV 75</b>		

**Accessories**

<b>ZB 22 CUS</b>	0824949	1
------------------	---------	---

# Surge protection and interference filters

## Surge protection for transceiver systems

### Protection for antenna inputs of radio and television equipment

#### C-SAT-BOX

- Protection for antenna inputs in satellite receiver technology
- Use before antenna distributor or multi-switch
- Analog and digital SAT signals
- Terrestrial antenna signals
- Direct wall mounting supported

#### C-TV-SAT and C-TV/HIFI

- Protective adapter for antenna connections
- Use on broadband cable or SAT connection
- TV or F connector

<b>Notes:</b>
For certifications, see page 154
Attenuation characteristics at <a href="http://www.phoenixcontact.net/products">www.phoenixcontact.net/products</a>



For antenna distributor or multi-switch



Adapter with F and IEC connector

Total width 140 mm

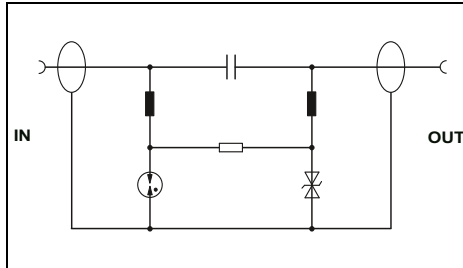

#### Technical data

<b>Electrical data</b>	
IEC category / EN type	B2 / C2 / C3 / D1 / C1
Maximum continuous operating voltage $U_C$	20 V DC / -
Nominal current $I_N$	400 mA (25°C)
Nominal discharge surge current $I_n$ (8/20) $\mu$ s	Core-Shield / Core-Ground 2.5 kA / 2.5 kA
Total surge current (8/20) $\mu$ s	10 kA
Output voltage limitation at 1 kV/ $\mu$ s	Core-Shield / Core-Ground $\leq 70$ V / $\leq 70$ V
Cut-off frequency $f_g$ (3 dB)	Symmetrical / Asymmetrical - / > 2.5 GHz
In a 75 $\Omega$ system	
<b>General data</b>	
Dimensions W / H / D	140 mm / 74 mm / 35 mm
Temperature range	-40 °C ... 80 °C
Degree of protection in acc. with IEC 60529/ EN 60529	IP40
Inflammability class in acc. with UL 94	-
Connection method	F connector
Test standards	IEC 61643-21 / EN 50083 - CLASS A

Total width 28 mm

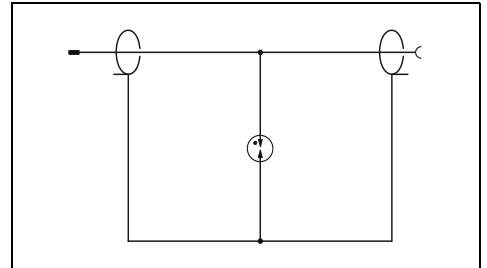

#### Technical data

<b>Electrical data</b>	
F-connector	TV connector
C1 / C2 / C3 / D1	C1 / C2 / C3 / D1
180 V DC / 130 V AC	180 V DC / 130 V AC
1.5 A (25°C)	1.5 A (25°C)
2.5 kA / -	2.5 kA / -
2.5 kA	2.5 kA
$\leq 600$ V / -	$\leq 600$ V / -
- / > 3 GHz	- / > 1 GHz
<b>General data</b>	
Dimensions W / H / D	28 mm / 66 mm / 44 mm
Temperature range	-25 °C ... 75 °C
Degree of protection in acc. with IEC 60529/ EN 60529	IP20
Inflammability class in acc. with UL 94	V0
Connection method	F connector PAL-TV (IEC 169-2)
Test standards	IEC 61643-21 / EN 50083 - CLASS A

#### Ordering data

<b>Description</b>
<b>COAXTRAB</b> , protective device for antenna distributors/multi-switches for insertion in the antenna line
<b>COAXTRAB</b> , surge protection adapter
F connector TV connector

Type	Order No.	Pcs. / Pkt.
C-SAT-BOX	2880561	1

#### Ordering data

Type	Order No.	Pcs. / Pkt.
C-TV-SAT	2856993	1
C-TV/HIFI	2857002	1

#### Accessories

<b>Adapter</b> , to connect the C-SAT-BOX with antenna distributors with a pitch of 20 mm (e.g. ASTRO, SPAUN)
<b>Connection cable</b> , to connect the C-SAT-BOX with the antenna distributor, length: 0.2 m

Type	Order No.	Pcs. / Pkt.
ADAPTER KOAX TYP F	2880972	5
KBL-SAT/20	2880985	5

#### Accessories

Type	Order No.	Pcs. / Pkt.



### For power supply and antenna inputs

<b>Notes:</b>
For certifications, see page 154
Attenuation characteristics at <a href="http://www.phoenixcontact.net/products">www.phoenixcontact.net/products</a>

- For termination devices
- Easy operation
- Connection to antenna junction box using separate cable
- Thermal monitoring of the protective circuit
- Green LED - operating indicator for the power supply



### For network and TV antennas/cables and SAT systems, with F connector and IEC adapter

Total width 63 mm

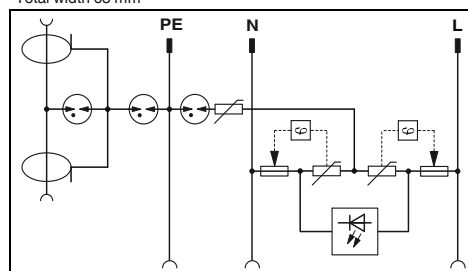

#### Technical data

Electrical data	Mains protection	Data protection
IEC category / EN type	III / T3	C2 / C3 / D1
Nominal voltage $U_N$	230 V AC	-
Maximum continuous operating voltage $U_C$	360 V AC (L/N-PE)	50 V AC / 72 V DC
Nominal current $I_N$	16 A (30 °C)	1.5 A (25 °C)
Nominal discharge surge current $I_n$ (8/20) $\mu$ s		
Combined surge $U_{oc}$	Core-Shield / Core-Ground 3 kA / 3 kA 4 kV	2.5 kA / 2.5 kA -
Protection level $U_p$		
Output voltage limitation at 1 kV/ $\mu$ s	Core-Shield / Core-Ground $\leq 1.2$ kV / $\leq 1.5$ kV	$\leq 700$ V (C2 - 2 kA) / -
Cut-off frequency $f_g$ (3 dB)	Core-Ground / Core-Shield / Shield-Ground - / -	- / $\leq 700$ V / $\leq 1$ kV
In a 75 $\Omega$ system	Core/Shield	> 2.5 GHz
General data		
Dimensions W / H / D	63 mm / 79 mm / 106.5 mm	
Temperature range	-25 °C ... 75 °C	
Degree of protection in acc. with IEC 60529/ EN 60529	IP20 (child-proof)	
Inflammability class in acc. with UL 94	V0/HB	
Connection method	F connector	
Test standards	IEC 61643-1	IEC 61643-21

#### Ordering data

Description	Can be used as typical for the country	Type	Order No.	Pcs. / Pkt.
<b>MAINTRAB</b> , surge protection attachment plug for plugging into a socket for equipment and data interface protection, incl. 1.5 m coaxial cable.				
Black	D, A, NL	<b>MNT-TV-SAT D</b>	<b>2882284</b>	1
White	D, A, NL	<b>MNT-TV-SAT D/WH</b>	<b>2882297</b>	1
Black	B, F, CZ, SVK, PL	<b>MNT-TV-SAT B/F</b>	<b>2882307</b>	1
White	S, FIN, N	<b>MNT-TV-SAT S/WH</b>	<b>2880888</b>	1

### SFP-TRAB



#### Reliable signals with mains interference filter

Switching operations triggered mechanically or electronically generate pulse-like and high-frequency interference voltages. These voltages spread in an unimpeded manner across the cable network. All the devices within this cable network are affected. Data errors, uncontrolled functions, and system crashes can result, with data processing devices at particular risk.

#### Interference voltage filters for power supply units

Interference filters limit conducted high-frequency interference voltages. Devices used in data processing or automation particularly benefit from a clean power supply. The end result is safe operation and reliable measured results.

#### Interference filters with type 3 surge protection

Interference filters with integrated type 3 surge protection have two tasks: they absorb surge voltages and also limit high-frequency interference voltages.

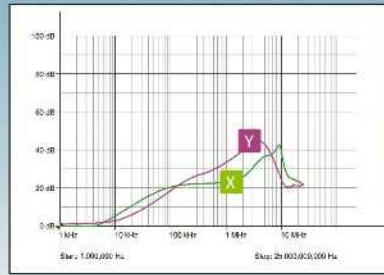
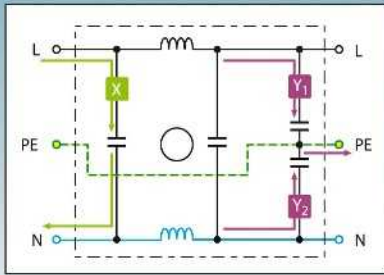

### Mains interference filters - operating principle and range

#### Filtering of symmetrical disturbance variables

**X** - Interference voltages between the phase and neutral conductor are filtered.

#### Filtering of asymmetrical disturbance variables

**Y<sub>1</sub>, Y<sub>2</sub>** - The opposite grounded interference voltages from phase to PE and from the neutral conductor to PE are filtered.

### Operating range of filters

An attenuation curve diagram illustrates the effective operating range of mains interference filters. The relevant frequency-dependent attenuation can be read according to the symmetrical or asymmetrical filter circuit.

### DIN-rail-mountable device protection with SFP-TRAB interference filter

- Combined protective circuit for absorbing transient surge voltages and high-frequency interference voltages
- Thermal monitoring of the protective circuit
- Disconnection status signaled via floating remote indication contact
- Can be installed in industrial environments

Notes:
For certifications, see page 154
Attenuation characteristics at <a href="http://www.phoenixcontact.net/products">www.phoenixcontact.net/products</a>



20 A nominal current

Total width 112 mm

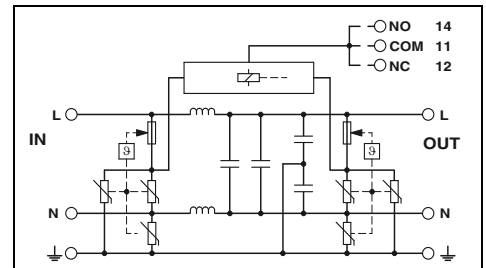

#### Technical data

Electrical data	... 230AC	... 120AC
IEC category / EN type	III / T3	III / T3
Nominal voltage $U_N$	230 V AC	120 V AC
Maximum continuous operating voltage $U_C$	DC/AC - / 264 V AC	- / 150 V AC
Nominal load current $I_L$	20 A (40°C)	20 A (40°C)
Nominal discharge surge current $I_n$ (8/20) $\mu$ s	L-N / L-PE 5 kA / 5 kA	3 kA / 3 kA
Max. discharge surge current $I_{max}$ (8/20) $\mu$ s	L-N / L-PE 10 kA / 10 kA	10 kA / 10 kA
Combined surge $U_{OC}$	10 kV	6 kV (3 kA)
Protection level $U_p$	L-N/L(N)-PE $\leq 1$ kV / $\leq 1$ kV	$\leq 450$ V / $\leq 450$ V
Response time $t_A$	L-N/L(N)-PE $\leq 25$ ns / $\leq 25$ ns	$\leq 25$ ns / $\leq 25$ ns
Backup fuse max. in acc. with IEC	20 A (gL / gG)	20 A (gL / gG)
Inductivity	Symmetrical 20 dB ( $\geq 100$ kHz / 50 $\Omega$ ) Asymmetrical 30 dB ( $\geq 1$ MHz / 50 $\Omega$ ) 2x 1 mH $\pm 30$ % (with current compensation)	Typ. 40 dB ( $\geq 500$ kHz / 50 $\Omega$ ) Typ. 30 dB ( $\geq 1$ MHz / 50 $\Omega$ ) 2x 1 mH $\pm 30$ % (with current compensation)
General data	112 mm / 93 mm / 79 mm	
Dimensions W / H / D	4 ... 6 mm <sup>2</sup> / 4 ... 4 mm <sup>2</sup> / 12 - 10	
Connection data solid / stranded / AWG	-40 °C ... 70 °C	
Temperature range	-25 °C ... 40 °C	
Inflammability class in acc. with UL 94	V0	
Test standards	IEC 61643-1 / DIN EN 61643-11 / EN 61643-11/A11 / UL 1449 / UL 1283	
Remote indication contact	PDT, 1-pos.	
Connection data solid / stranded / AWG	0.14 ... 1.5 mm <sup>2</sup> / 0.14 ... 1.5 mm <sup>2</sup> / 28 - 16	
Max. operating voltage	250 V AC / -	
Max. operating current	1 A (250 V AC) / 0.25 A (250 V DC) / 1 A (48 V DC)	

#### Ordering data

Description	Voltage $U_N$	Type	Order No.	Pcs. / Pkt.
<b>SFP-TRAB</b> , DIN rail-mountable device protection with integrated mains interference filter and optical signaling				
Nominal current: 20 A	230 V AC	<b>SFP 1-20/230AC</b>	<b>2859987</b>	1
Nominal current: 20 A	120 V AC	<b>SFP 1-20/120AC</b>	<b>2856702</b>	1
<b>SFP-TRAB</b> , DIN rail-mountable device protection with integrated mains interference filter and optical signaling				
Nominal current: 5 A	120 V AC			
Nominal current: 10 A	120 V AC			
Nominal current: 15 A	120 V AC			



5 A nominal current



10 A nominal current

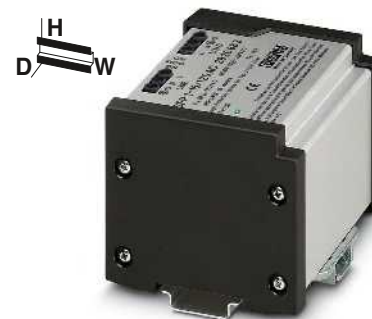

15 A nominal current

Total width 112 mm

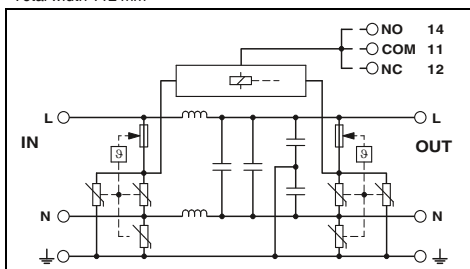

Technical data

III / T3  
 120 V AC  
 - / 150 V AC  
 5 A (72°C)  
 3 kA / 3 kA  
 10 kA / 10 kA  
 6 kV (3 kA)  
 ≤ 450 V / ≤ 450 V  
 ≤ 25 ns / ≤ 25 ns  
 20 A (gL / gG)

Typ. 40 dB (≥ 500 kHz / 50 Ω)  
 Typ. 30 dB (≥ 1 MHz / 50 Ω)  
 2x 1 mH ±30 % (with current compensation)

112 mm / 93 mm / 79 mm  
 4 ... 6 mm<sup>2</sup> / 4 ... 4 mm<sup>2</sup> / 12 - 10  
 -25 °C ... 70 °C  
 V0  
 IEC 61643-1 / EN 61643-11/A11 / UL 1449 /  
 UL 1283  
 PDT, 1-pos.  
 0.14 ... 1.5 mm<sup>2</sup> / 0.14 ... 1.5 mm<sup>2</sup> / 28 - 16  
 250 V AC / -  
 1 A (250 V AC) / 0.25 A (250 V DC) / 1 A (48 V DC)

Ordering data

Type	Order No.	Pcs. / Pkt.
SFP 1-5/120AC	2920667	1

Total width 112 mm

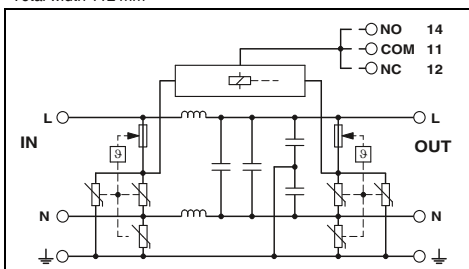

Technical data

III / T3  
 120 V AC  
 - / 150 V AC  
 10 A (62°C)  
 3 kA / 3 kA  
 10 kA / 10 kA  
 6 kV (3 kA)  
 ≤ 450 V / ≤ 450 V  
 ≤ 25 ns / ≤ 25 ns  
 20 A (gL / gG)

Typ. 40 dB (≥ 500 kHz / 50 Ω)  
 Typ. 30 dB (≥ 1 MHz / 50 Ω)  
 2x 1 mH ±30 % (with current compensation)

112 mm / 93 mm / 79 mm  
 4 ... 6 mm<sup>2</sup> / 4 ... 4 mm<sup>2</sup> / 12 - 10  
 -25 °C ... 60 °C  
 V0  
 IEC 61643-1 / EN 61643-11/A11 / UL 1449 /  
 UL 1283  
 PDT  
 0.14 ... 1.5 mm<sup>2</sup> / 0.14 ... 1.5 mm<sup>2</sup> / 28 - 16  
 250 V AC / -  
 1 A (250 V AC) / 0.25 A (250 V DC) / 1 A (48 V DC)

Ordering data

Type	Order No.	Pcs. / Pkt.
SFP 1-10/120AC	2920670	1

Total width 112 mm

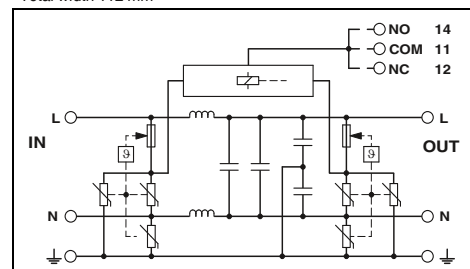

Technical data

III / T3  
 120 V AC  
 - / 150 V AC  
 15 A (52 °C)  
 3 kA / 3 kA  
 10 kA / 10 kA  
 6 kV (3 kA)  
 ≤ 450 V / ≤ 450 V  
 ≤ 25 ns / ≤ 25 ns  
 20 A (gL / gG)

Typ. 40 dB (≥ 500 kHz / 50 Ω)  
 Typ. 30 dB (≥ 1 MHz / 50 Ω)  
 2x 1 mH ±30 % (with current compensation)

112 mm / 93 mm / 79 mm  
 4 ... 6 mm<sup>2</sup> / 4 ... 4 mm<sup>2</sup> / 12 - 10  
 -25 °C ... 50 °C  
 V0  
 IEC 61643-1 / EN 61643-11/A11 / UL 1449 /  
 UL 1283  
 PDT  
 0.14 ... 1.5 mm<sup>2</sup> / 0.14 ... 1.5 mm<sup>2</sup> / 28 - 16  
 250 V AC / -  
 1 A (250 V AC) / 0.25 A (250 V DC) / 1 A (48 V DC)

Ordering data

Type	Order No.	Pcs. / Pkt.
SFP 1-15/120AC	2920683	1

# Surge protection and interference filters

## EMC solutions

### TERMITRAB

- Combined protective circuit for absorbing transient surge voltages and high-frequency interference voltages
- With spring-cage connection
- Disconnection of signal circuits by disconnect knife

<b>Notes:</b>
For certifications, see page 154
Attenuation characteristics at <a href="http://www.phoenixcontact.net/products">www.phoenixcontact.net/products</a>



Protection for two conductors with a common reference potential

Total width 6.2 mm

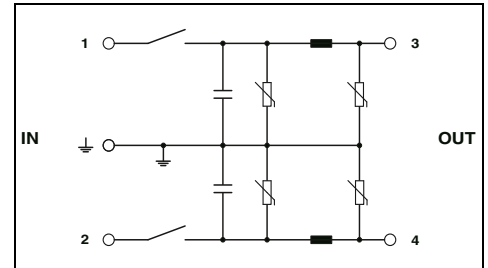

#### Technical data

<b>Electrical data</b>	
IEC category / EN type	C1 / C3
Maximum continuous operating voltage $U_c$	DC/AC 38 V DC / 30 V AC
Nominal load current $I_n$	0.5 A (55°C)
Nominal discharge surge current $I_n$ (8/20) $\mu$ s	
Total surge current (8/20) $\mu$ s	Core-Ground 350 A
Output voltage limitation at 1 kV/ $\mu$ s	700 A
Core-Ground	
Output voltage limitation at 1 kV/ $\mu$ s	Core-Ground $\leq 70$ V
Core-Ground	
Cut-off frequency fg (3 dB)	Typ. 60 kHz
Asymmetrical in the 50 $\Omega$ system	
Resistance per path	0.5 $\Omega$
Inductance per path	100 $\mu$ H (per path)
Capacitance per path	130 nF
<b>General data</b>	
Connection data solid / stranded / AWG	0.2 ... 4 mm <sup>2</sup> / 0.2 ... 2.5 mm <sup>2</sup> / 24 - 12
Temperature range	-40 °C ... 85 °C
Degree of protection in acc. with IEC 60529/ EN 60529	IP20
Inflammability class in acc. with UL 94	V2
Test standards	IEC 61643-21/A1 / EN 61643-21/A1

#### Ordering data

Description	Voltage $U_N$
<b>TERMITRAB</b> , spring-cage modular terminal block with integrated surge protection as a filter circuit and disconnect knives, for mounting on NS 35	24 V AC

Type	Order No.	Pcs. / Pkt.
<b>TT-ST-M-SFP-24AC</b>	2858946	10

#### Accessories

<b>Cover</b> , for terminating a row of terminal blocks
<b>Zack marker strip</b> , 10-section, white

<b>TT-D-STTCO-BK</b>	2858894	50
ZB 6, see page 111		

**FILTRAB**

- Low pass filters for nominal currents of 1 to 10 A
- For single-phase circuits
- Rail-mountable module

<b>Notes:</b>
For certifications, see page 154
Attenuation characteristics at <a href="http://www.phoenixcontact.net/products">www.phoenixcontact.net/products</a>



1 A / 3 A nominal current

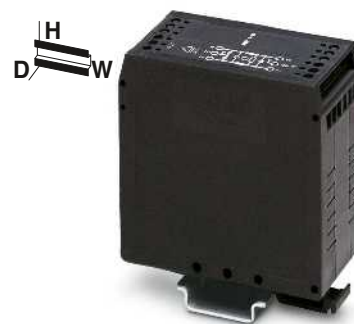

6 A / 10 A nominal current

Total width 25 mm

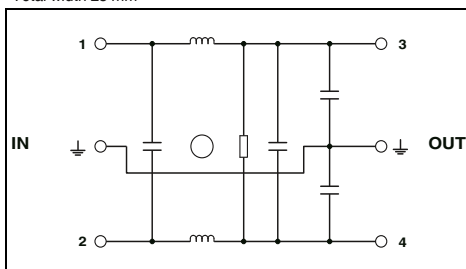

Total width 40 mm

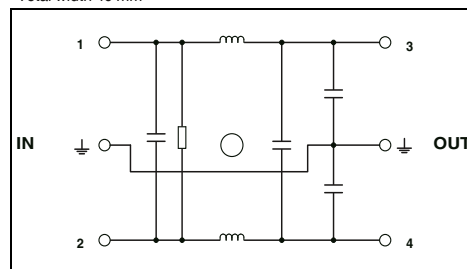

<b>Electrical data</b>	
Nominal voltage $U_N$	240 V AC
Maximum continuous operating voltage $U_C$	264 V AC
Nominal load current $I_L$	1 A (40°C)
Backup fuse max. in acc. with IEC	1 A (gL)
Inductivity	2x 10 mH
Input attenuation $a_i$	Symmetrical $\geq 65$ dB (50 $\Omega$ / 1 MHz) Asymmetrical $\geq 45$ dB (50 $\Omega$ / 1 MHz)
<b>General data</b>	
Dimensions W / H / D	25 mm / 79.4 mm / 84.15 mm
Connection data solid / stranded / AWG	0.2 ... 4 mm <sup>2</sup> / 0.2 ... 2.5 mm <sup>2</sup> / 24 - 12
Temperature range	-25 °C ... 100 °C (HMF)
Inflammability class in acc. with UL 94	V2
Test standards	IEC 60939-2 / DIN EN 60939-2

Technical data	
NEF 1- 1	NEF 1- 3
240 V AC	240 V AC
264 V AC	264 V AC
1 A (40°C)	3 A (40°C)
1 A (gL)	3 A (gL)
2x 10 mH	2x 2.7 mH
Symmetrical	$\geq 55$ dB (50 $\Omega$ / 1 MHz)
Asymmetrical	$\geq 35$ dB (50 $\Omega$ / 1 MHz)
25 mm / 79.4 mm / 84.15 mm	
0.2 ... 4 mm <sup>2</sup> / 0.2 ... 2.5 mm <sup>2</sup> / 24 - 12	
-25 °C ... 100 °C (HMF)	
V2	
IEC 60939-2 / DIN EN 60939-2	

Technical data	
NEF 1- 6	NEF 1-10
240 V AC	240 V AC
264 V AC	264 V AC
6 A (40°C)	10 A (40°C)
6.3 A (gL/C)	10 A (gL)
2x 2.7 mH	2x 1.8 mH
> 80 dB (50 $\Omega$ / 1 MHz)	> 80 dB (50 $\Omega$ / 1 MHz)
> 40 dB (50 $\Omega$ / 1 MHz)	> 40 dB (50 $\Omega$ / 1 MHz)
40 mm / 79.4 mm / 84.1 mm	
0.2 ... 4 mm <sup>2</sup> / 0.2 ... 2.5 mm <sup>2</sup> / 24 - 12	
-25 °C ... 100 °C (HMF)	
V2	
IEC 60939-2 / DIN EN 60939-2	

Description	Nominal load current $I_L$
<b>FILTRAB</b> , interference filter for single-phase current circuits, for mounting on NS 32 or NS 35...	
	1 A
	3 A
	6 A
	10 A

Ordering data		
Type	Order No.	Pcs. / Pkt.
NEF 1- 1	2794123	10
NEF 1- 3	2794110	10

Ordering data		
Type	Order No.	Pcs. / Pkt.
NEF 1- 6	2783082	5
NEF 1-10	2788977	5

<b>Labeling material</b>
--------------------------

Accessories	
For ZB 5..., see page 111	

Accessories	
For ZB 5..., see page 111	

# Surge protection and interference filters

## Test device

### CHECKMASTER – the arrester test system

Lightning protection systems must be regularly tested in accordance with the requirements of IEC 62305-3 and official regulations. A basic visual check is not enough to identify surge protective devices that were previously damaged. Only an electrical check using the CHECKMASTER produces meaningful results. The test device checks all the relevant components of an arrester. The nominal data of protective elements, such as spark gaps, varistors, gas-filled surge arresters, and suppressor diodes, is tested in a single test cycle.

The CHECKMASTER offers real advantages for safety in all sectors where a high level of system availability is crucial.





## User-friendly and reliable testing of plug-in arresters in just four steps

### 1. Easy selection

The CHECKMASTER has a modular design. Various test sockets are compatible with the various plugs. Further information about the test sockets required can be found on the next page.



### 2. User-friendly scanning

The barcodes on the surge protective devices present a fast and error-free solution for entering items. System-specific abbreviations or user-defined IDs can be entered via the operator interface or read in from the individually created barcode labels.



### 3. Safe testing

When started, an automatic test process is run which checks the arresters with regard to their specific electrical properties. The results are visualized via the display and via two signal lamps.



The protective plug is OK and can be used.

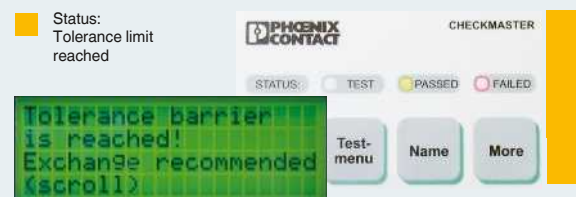

The protective plug has been damaged – replacement is recommended.



The protective plug is faulty and must be replaced.

### 4. Fast logging

The tests are documented according to IEC 62305-3. In addition to the immediate processing of all test values, the CHECKMASTER also allows the contents of the internal memory to be exported directly to an Excel worksheet, for example.



# Surge protection and interference filters

## Test device

### CHECKMASTER

- Modular test device for virtually all plug-in surge arresters from Phoenix Contact
- Corresponding test sockets are available for the arrester connectors
- Test sockets can be easily changed
- Easy operation thanks to barcode scanner or keypad
- Optional entry of system-specific name for protective devices
- Documentation of test results

**The test socket for PLUGTRAB PT is included in the scope of supply of the CHECKMASTER.**

### Case for transporting test sockets PA-CASE

- Six padded compartments
- Sufficient space for all connecting cables
- The test adapters are not supplied as standard with the PA-CASE.

### CM-KBL-RS232/USB

- Adapter cable
- For connection of the test device to a laptop/PC

### CM-KBL-PROG

- Necessary for updating CHECKMASTER firmware

Free software for updating CHECKMASTER can be found at the Download Center on Phoenix Contact's homepage.

The operation of the CHECKMASTER and that of the CM-PA sockets do not meet the general protection requirements for residential areas. Please take the appropriate precautions.

Notes:
Dimensional drawing at: <a href="http://www.phoenixcontact.net/products">www.phoenixcontact.net/products</a>
The programming cable has a special pin assignment. It can be used only to update the CHECKMASTER software!
1) EMC: Class A product, see page 287



Arrester test device

Total width 450 mm

#### Technical data

230 V AC (100 V AC ... 240 V AC)  
 5 °C ... 35 °C  
 IP20  
 RS-232

#### Ordering data

Description	Type	Order No.	Pcs. / Pkt.
<b>Test device</b> , for the function test of TRABTECH protective devices, incl. CM-PA-PT for PLUGTRAB PT	CHECKMASTER <sup>1)</sup>	2838924	1
<b>Transport case</b> , to accommodate 6 TRABTECH test adapters CM-PA...			
<b>TRABTECH test adapter</b> , for testing the function of:  FLASHTRAB compact and VALVETRAB compact COMTRAB CTM COMTRAB CT 10 PLUGTRAB PT PLUGTRAB UFBK, UAK TF-TRAB VALVETRAB			
<b>USB RS232 converter</b> , D-SUB, 9-pos. to USB, type A, 4-pos. D-SUB adapter, 25-pos. to D-SUB, 9-pos.			
<b>Update cable</b> , for CHECKMASTER firmware updates			



Transport case for test sockets



Test sockets



Data cable

Ordering data			Ordering data			Ordering data		
Type	Order No.	Pcs. / Pkt.	Type	Order No.	Pcs. / Pkt.	Type	Order No.	Pcs. / Pkt.
PA-CASE	2858988	1						
			CM-PA-FLT/VAL-CP <sup>1)</sup>	2880392	1			
			CM-PA-CTM <sup>1)</sup>	2816962	1			
			CM-PA-CT10 <sup>1)</sup>	2816959	1			
			CM-PA-PT <sup>1)</sup>	2882844	1			
			CM-PA-PT/A <sup>1)</sup>	2816933	1			
			CM-PA-TF <sup>1)</sup>	2816975	1			
			CM-PA-VAL-MS <sup>1)</sup>	2800104	1			
						CM-KBL-RS232/USB	2881078	1
						CM-KBL-PROG	2881557	1

## Approvals

Type	Order No.	Certification	Type	Order No.	Certification
<b>B</b>			<b>D</b>		
BNC-DV 50	2805038		CTM 2X1-180DC-GS-P	2838623	
BNC-DV 75	2805083		CTM EST	2838649	
BNC-V 50	2805041		CTM ISDN	2838555	
BNC-V 75	2805070		CT-TERMILOCK 10 DA	0441711	
BT-1S-230AC/A	2803409		C-TV/HIFI	2857002	
BT-1S-230AC/O	2800625		C-TV-SAT	2856993	
BT-SKT 230/A	2859343		C-UB/E	2763701	
<b>C</b>			C-UBF- 5DC	2797858	
CHECKMASTER	2838924		C-UBF- 5DC/E	2782300	
CM-KBL-PROG	2881557		C-UBF- 5DC/E 75	2763604	
CM-KBL-RS232/USB	2881078		C-UBF-24DC	2797861	
CM-PA-CT10	2816959		C-UBF-24DC/E	2782313	
CM-PA-CTM	2816962		<b>D</b>		
CM-PA-FLT/VAL-CP	2880392		D-DEK 1,5 BK	2838995	
CM-PA-PT	2882844		D-DEK 1,5 BU	2838982	
CM-PA-PT/A	2816933		D-DS1-A/RJ45-BB	2838050	
CM-PA-TF	2816975		DK-BIC-35	2749880	
CN-LAMBDA/4-0.47-BB	2800021		D-LAN-19"-12	2880150	
CN-LAMBDA/4-0.47-SB	2800022		D-LAN-19"-16	2880147	
CN-LAMBDA/4-5.9-BB	2838490		D-LAN-19"-20	2880134	
CN-LAMBDA/4-5.9-SB	2800023		D-LAN-19"-24	2838791	
CN-UB/E	2763691		D-LAN-19"-4	2880176	
CN-UB/E-BB	2817686		D-LAN-19"-8	2880163	
CN-UB/MP	2818135		D-LAN-19"-D-P	2880192	
CN-UB/MP-90DEG-50	2803137		D-LAN-CAT.5-FP	2800723	
CN-UB-70DC-6-BB	2803166		DP-UKK 3/5 BK	2770833	
CN-UB-70DC-6-SB	2803153		D-TERMITRAB-UK 5	2794990	
C-SAT-BOX	2880561		DT-LAN-CAT.6+	2881007	
CT 1-10-ES	2765547		DT-TELE-RJ45	2882925	
CT 10-18FS+F/PE-24	2807926		DT-UBF-485/BS	2920612	
CT 10-18FSR+F/PE-24	2807939		DT-UBF-IB-RB0	2800056	
CT 10-2/2-GS	2765398		DT-UBF-IB-RBI	2800055	
CT 10-2/2-GS/3E	2765408		DT-UBF-V24/S-9-SB	2803069	
CT 10-2/2-GS/3E-110AC	2920829		DT-UBF-V24/S-SB-SET	2803072	
CT 10-2PE/FS-24	2807955		D-UBF-PB	2880642	
CT 10-2PE/FSR-24	2807968		D-UKK 3/5 BK	2770228	
CT 10-9VA-230AC	2830498		<b>F</b>		
CT 10-MB/ 3	2765372		FLT 100 N/PE-1.5	2800303	
CT 10-MB/10	2765385		FLT 100 N/PE-1.5	2800303	
CT 10-TL	2765356		FLT-CP-1C-350	2859741	
CTM 10-MAG	2838610		FLT-CP-1S-350	2859738	
CTM 1X2- 12DC	2838597		FLT-CP-2C-350	2859770	
CTM 1X2- 24DC	2838513		FLT-CP-2S-350	2859767	
CTM 1X2- 60DC	2838568		FLT-CP-350-ST	2881887	
CTM 1X2-110AC	2838539		FLT-CP-3C-350	2859725	
CTM 2X1- 12DC	2838584		FLT-CP-3S-350	2859712	
CTM 2X1- 24DC	2838500		FLT-CP-N/PE-350	2859754	
CTM 2X1- 5DC	2838571		FLT-CP-N/PE-350-ST	2859686	
CTM 2X1- 60DC	2838542		FLT-CP-PLUS-1C-350	2882695	
CTM 2X1-110AC	2838526		FLT-CP-PLUS-1S-350	2882682	
CTM 2X1-180DC-GS	2838636		FLT-CP-PLUS-2C-350	2882679	
			FLT-CP-PLUS-2S-350	2882666	
			FLT-CP-PLUS-350-ST	2859913	

Type	Order No.	Certification	Type	Order No.	Certification
FLT-CP-PLUS-3C-350	2882653		PRT-CD-AD1	2749673	
FLT-CP-PLUS-3S-350	2882640		PT 1X2- 5DC-ST	2856016	
FLT-PLUS CTRL-2.5	2800121		PT 1X2+F-BE	2856126	
FLT-PLUS CTRL-2.5/I	2800122		PT 1X2-12AC-ST	2856045	
FLT-PLUS CTRL-3.0	2800168		PT 1X2-12DC-ST	2856029	
FLT-PLUS CTRL-3.0/I	2800170		PT 1X2-24AC-ST	2856058	
F-MS 12	2817987		PT 1X2-24DC-ST	2856032	
F-MS 12 ST	2817990		PT 1X2-48DC-ST	2803658	
F-MS 12/FM	2817974		PT 1X2-BE	2856113	
F-MS 2200/30 ST	2805392		PT 2+1-S-48DC/FM	2817958	
F-MS 80 ST	2921307		PT 2+1-S-48DC-ST	2839648	
F-MS-T1/T2 50 ST	2800191		PT 2-F-ST	2859000	
<b>K</b>			PT 2-IT-230AC/FM	2805130	
KBL-SAT/20	2880985		PT 2-IT-230AC-ST	2805127	
<b>L</b>			PT 2-PE/S- 24AC-ST	2839318	
LIT 1X2-24	2804610		PT 2-PE/S- 60AC-ST	2839321	
LIT 2-12	2804694		PT 2-PE/S-120AC/FM	2856812	
LIT 2-24	2804665		PT 2-PE/S-120AC-ST	2839334	
LIT 2X1-24	2804636		PT 2-PE/S-230AC/FM	2858357	
LIT 2X2-24	2804623		PT 2-PE/S-230AC-ST	2839347	
LIT 4-12	2804704		PT 2-PE/S-24AC/FM	2800457	
LIT 4-24	2804678		PT 2-TELE	2882828	
LIT 4X1-24	2804649		PT 2-TELE-ST	2838733	
<b>M</b>			PT 2X1- 5DC-ST	2856061	
ME 6,2 TBUS-2 1,5/5-ST-3,81KMGY	2969401		PT 2X1+F-BE	2856142	
MINI MCR-SL-V8-FLK 16-A	2811268		PT 2X1-12AC-ST	2856090	
MNT-1 CH II	2882255		PT 2X1-12DC-ST	2856074	
MNT-1 D	2882200		PT 2X1-24AC-ST	2856100	
MNT-1 D/WH	2882213		PT 2X1-24DC-ST	2856087	
MNT-1 E	2882239		PT 2X1-BE	2856139	
MNT-1 S/WH	2880862		PT 2X1VA- 60AC-ST	2839172	
MNT-ISDN D	2882336		PT 2X1VA-120AC-ST	2839185	
MNT-ISDN D/WH	2882349		PT 2X1VA-230AC-ST	2839198	
MNT-ISDN S/WH	2880891		PT 2X1-VF-120AC	2859327	
MNT-NET B/F	2882226		PT 2X1-VF-120AC-ST	2856799	
MNT-POWERLINE	2858001		PT 2X1-VF-230AC	2805460	
MNT-TAE D	2882381		PT 2X1-VF-230AC-ST	2921365	
MNT-TAE D/WH	2882394		PT 2X2- 5DC-ST	2838241	
MNT-TEL B/F	2882404		PT 2X2+F-BE	2839224	
MNT-TELE E	2882417		PT 2X2-12AC-ST	2838270	
MNT-TELE N/WH	2881764		PT 2X2-12DC-ST	2838254	
MNT-TELE S/WH	2880901		PT 2X2-24AC-ST	2838283	
MNT-TV-SAT B/F	2882307		PT 2X2-24DC-ST	2838228	
MNT-TV-SAT D	2882284		PT 2X2-BE	2839208	
MNT-TV-SAT D/WH	2882297		PT 2X2-HF- 5 DC-ST	2839567	
MNT-TV-SAT S/WH	2880888		PT 2X2-HF-12 DC-ST	2839570	
<b>N</b>			PT 2X2-HF-24 DC-ST	2839729	
NEF 1- 1	2794123		PT 2XEX(I)-24DC-ST	2838225	
NEF 1- 3	2794110		PT 2XEX(I)-BE	2839279	
NEF 1- 6	2783082		PT 3-HF-12DC-ST	2858043	
NEF 1-10	2788977		PT 3-PB-ST	2858030	
<b>P</b>			PT 4- 5DC-ST	2839211	
PAS-1	2765615		PT 4+F-BE	2839415	
			PT 4-12DC-ST	2839237	

## Approvals

Type	Order No.	Certification	Type	Order No.	Certification
PT 4-12DC-ST	2839237		T		
PT 4-24DC-ST	2839240		TAE-TRAB FM-NFN-AP	2749628	
PT 4-BE	2839402		TT-2/2- 24DC	2838173	
PT 4-EX(I)-24DC-ST	2839253		TT-2/2-M-24DC	2920722	
PT 4-EX(I)-BE	2839486		TT-2-PE- 24DC	2838186	
PT 4-F-ST	2858441		TT-2-PE/S1- 24DC	2839538	
PT 4-PE/S-230AC/FM	2882459		TT-2-PE/S1-M-24DC	2920638	
PT 4-PE/S-230AC-ST	2882462		TT-2-PE-110AC	2858483	
PT 4X1- 5DC-ST	2838306		TT-2-PE-M-24DC	2920641	
PT 4X1+F-BE	2839376		TT-D-2-PE-M-BK	2920654	
PT 4X1-12AC-ST	2838348		TT-D-2-PE-M-BU	2803878	
PT 4X1-12DC-ST	2838319		TT-D-ST-BU	2856773	
PT 4X1-24AC-ST	2838351		TT-D-STTCO-BK	2858894	
PT 4X1-24DC-ST	2838322		TT-EX(I)- 24DC	2832124	
PT 4X1-48AC-ST	2804856		TT-EX(I)-M-24DC	2803865	
PT 4X1-48DC-ST	2858014		TT-SLKK5/ 12DC	2794893	
PT 4X1-BE	2839363		TT-SLKK5/ 24DC	2794903	
PT 5-HF- 5 DC-ST	2838762		TT-SLKK5/ 48DC	2794916	
PT 5-HF-12 DC-ST	2838775		TT-SLKK5-F/110AC	2765602	
PT MAIN-EST	2880736		TT-SLKK5-S- 12DC	2809597	
PT MCR-EST	2880749		TT-SLKK5-S- 24DC	2809607	
PT PE/S+1X2-24-ST	2819008		TT-SLKK5-S- 48DC	2809610	
PT PE/S+1X2-BE	2856265		TT-ST-2/2-24DC	2858881	
PT-BE/FM	2839282		TT-ST-2-PE-24DC	2858878	
S			TT-ST-M-2/2-24AC	2858933	
SFP 1-10/120AC	2920670		TT-ST-M-2/2-24DC	2858917	
SFP 1-15/120AC	2920683		TT-ST-M-2-PE-24AC	2858920	
SFP 1-20/120AC	2856702		TT-ST-M-2-PE-24DC	2858904	
SFP 1-20/230AC	2859987		TT-ST-M-EX(I)-24DC	2859424	
SFP 1-5/120AC	2920667		TT-ST-M-SFP-24AC	2858946	
S-PT-1X2-24DC	2880668		TT-UK5/ 12DC	2794686	
S-PT-1X2-24DC-1/2"	2882569		TT-UK5/ 24DC	2794699	
S-PT-1X2-24DC-3/4"	2882598		TT-UK5/ 48DC	2794709	
S-PT-2XEX-24DC	2800040		TT-UKK5-M/ 24DC	2795960	
S-PT-2XEX-48DC	2800038		TT-UKK5-M/ 48DC	2795973	
S-PT-4-EX-24DC	2800036		TT-UKK5-M/ 60DC	2795986	
S-PT-EX(I)-24DC	2880671		V		
S-PT-EX(I)-24DC-1/2"	2882572		VAL-CP-175-ST	2859628	
S-PT-EX(I)-24DC-3/4"	2882585		VAL-CP-1S-175	2859479	
S-PT-EX-24DC	2800034		VAL-CP-1S-350	2859563	
S-PT-EX-48DC	2800053		VAL-CP-1S-350/O	2881036	
SVP 2E- 48AC	2788919		VAL-CP-2C-175	2859482	
SVP 2E-110AC	2765534		VAL-CP-2C-350	2859589	
SVP 3E-110AC	2765521		VAL-CP-2C-350/O	2881052	
SYS N4 120/208Y	2800704		VAL-CP-2S-175	2859495	
SYS N4 120/240HLD	2800706		VAL-CP-2S-350	2859505	
SYS N4 120/240S	2800705		VAL-CP-2S-350/O	2881049	
SYS N4 277/480Y	2800703		VAL-CP-350-ST	2859602	
SYS N4 480D	2800707		VAL-CP-350-ST-GY	2882718	
SYS N4X 120/240HLD	2800716		VAL-CP-3C-175	2859466	
SYS N4X 120/240S	2800715		VAL-CP-3C-350	2859547	
SYS N4X 277/480Y	2800713		VAL-CP-3C-350/O	2881023	
			VAL-CP-3S-175	2859453	

Type	Order No.	Certification
VAL-CP-3S-350	2859521	
VAL-CP-3S-350/O	2881010	
VAL-CP-MCB-1S-350/40/FM	2882763	
VAL-CP-MCB-3C-350/40/FM	2882776	
VAL-CP-MCB-3S-350/40/FM	2882750	
VAL-CP-MOSO 60-3C-FM	2804416	
VAL-CP-MOSO 60-3S-FM	2804403	
VAL-CP-N/PE-350-ST	2859699	
VAL-CP-N/PE-350-ST-GY	2882734	
VAL-CP-RCD-3S/40/0.03	2882802	
VAL-CP-RCD-3S/40/0.3/SEL	2808001	
VAL-MS 60 ST	2807573	
VAL-MS 1000PV ST	2805185	
VAL-MS 120 ST	2807586	
VAL-MS 230	2839127	
VAL-MS 230 IT ST	2807599	
VAL-MS 230 ST	2798844	
VAL-MS 230/1+1	2804429	
VAL-MS 230/1+1-FM	2804432	
VAL-MS 230/2+0	2800103	
VAL-MS 230/2+0-FM	2800102	
VAL-MS 230/3+1	2838209	
VAL-MS 230/3+1 FM	2838199	
VAL-MS 230/FM	2839130	
VAL-MS 320 ST	2838843	
VAL-MS 320/1+1	2804380	
VAL-MS 320/1+1-FM	2804393	
VAL-MS 320/3+0	2920230	
VAL-MS 320/3+0-FM	2920243	
VAL-MS 320/3+1	2859178	
VAL-MS 320/3+1/FM	2859181	
VAL-MS 320/3+1/FM-UD	2856689	
VAL-MS 320-UD ST	2858315	
VAL-MS 350 VF ST	2856595	
VAL-MS 350 VF/FM	2856579	
VAL-MS 350VF	2856582	
VAL-MS 385/65 ST	2920308	
VAL-MS 385/65/1+1	2921255	
VAL-MS 385/65/1+1-FM	2921242	
VAL-MS 385/65/3+0	2921019	
VAL-MS 385/65/3+0-FM	2921006	
VAL-MS 385/65/3+1	2920890	
VAL-MS 385/65/3+1-FM	2920887	
VAL-MS 385/80 ST	2920353	
VAL-MS 385/80/1+1	2921297	
VAL-MS 385/80/1+1-FM	2921284	
VAL-MS 385/80/3+0	2921093	
VAL-MS 385/80/3+0-FM	2921080	
VAL-MS 385/80/3+1	2920971	
VAL-MS 385/80/3+1-FM	2920968	
VAL-MS 400 ST	2816399	
VAL-MS 500 ST	2807609	
VAL-MS 580/3+0	2920450	

Type	Order No.	Certification
VAL-MS 580/3+0-FM	2920447	
VAL-MS 580-ST	2920434	
VAL-MS 60	2868020	
VAL-MS 60/FM	2868033	
VAL-MS 75 VF ST	2805318	
VAL-MS 750/30/3+0	2920269	
VAL-MS 750/30/3+0-FM	2920272	
VAL-MS 750/30-ST	2920256	
VAL-MS 800/30 VF/FM	2805402	
VAL-MS BE	2817741	
VAL-MS BE/FM	2817738	
VAL-MS/2+0-BE	2804584	
VAL-MS/2+0-BE/FM	2805321	
VAL-MS/3+0-BE	2881816	
VAL-MS/3+0-BE/FM	2881803	
VAL-MS-T1/T2 175/12.5 ST	2800676	
VAL-MS-T1/T2 175/12.5/1+1	2800675	
VAL-MS-T1/T2 175/12.5/1+1-FM	2800674	
VAL-MS-T1/T2 175/12.5/3+0	2800673	
VAL-MS-T1/T2 175/12.5/3+0-FM	2800672	
VAL-MS-T1/T2 175/12.5/3+1	2800671	
VAL-MS-T1/T2 175/12.5/3+1-FM	2800670	
VAL-MS-T1/T2 335/12.5 ST	2800190	
VAL-MS-T1/T2 335/12.5/1+1	2800187	
VAL-MS-T1/T2 335/12.5/1+1-FM	2800186	
VAL-MS-T1/T2 335/12.5/3+0	2800189	
VAL-MS-T1/T2 335/12.5/3+0-FM	2800188	
VAL-MS-T1/T2 335/12.5/3+1	2800184	
VAL-MS-T1/T2 335/12.5/3+1-FM	2800183	
VAL-MS-T1/T2 335/12.5/4+0	2800645	
VAL-MS-T1/T2 335/12.5/4+0-FM	2800644	
VAL-US 120 ST	2800739	
VAL-US 240 ST	2800740	
VAL-US 277 ST	2800741	
VAL-US 347 ST	2800742	
VAL-US 480 ST	2800743	
VAL-US 60 ST	2800738	

W

WT-RJ 12-S/FM A/K AP	2809186	
WT-RJ 45-S/SDN1/K AP	2809830	





# Power supply units and UPS

## For maximum system availability

### Power supply units

Thanks to high-quality products featuring leading technology, our QUINT, TRIO, MINI, UNO, and STEP POWER product ranges optimally equip you for international competition.

### DC/DC converter

Change the voltage level, regenerate the voltage at the end of long cables or enable the creation of independent supply systems with the QUINT and MINI DC/DC converters.

### Redundancy modules

A redundant power supply system is the result of the parallel connection of two power supply units. Optimize this solution with the QUINT ORING redundancy modules and the QUINT, TRIO, and STEP diodes for maximum system availability.

### Uninterruptible power supply (UPS) units for control cabinets

IQ technology is the key to an intelligent power supply solution. The UPS monitors and optimizes the power storage device. Avoid interruptions when working with the intelligent UPS for non-stop power.

### Uninterruptible power supply (UPS) for 19" racks/towers

Protect all connected loads against any faults on the mains side with the single-phase VFI-SS-111 UPS devices.





## Power supply units and UPS

<b>Selection guide</b>	<b>160</b>
<b>Power supply units</b>	<b>164</b>
QUINT POWER	166
TRIO POWER	174
MINI POWER	180
UNO POWER	184
STEP POWER	186
QUINT POWER, dip-coated	194
<b>DC/DC converters</b>	<b>196</b>
QUINT DC/DC converters	198
DC/DC converter, dip-coated	200
MINI DC/DC converter	202
<b>Redundancy modules</b>	<b>204</b>
QUINT ORING	206
TRIO DIODE	208
QUINT DIODE	210
STEP DIODE	210
<b>Accessories</b>	<b>212</b>
<b>Uninterruptible power supply units for the control cabinet</b>	<b>214</b>
Selection guide	216
QUINT UPS-IQ	218
Power storage device for QUINT UPS-IQ	222
Accessories	228
UPS module with integrated power storage	230
UPS module with integrated power supply unit	234
Power storage devices for TRIO UPS and MINI UPS	236
<b>Uninterruptible power supply units for 19" racks/towers</b>	<b>240</b>
Selection guide	242
UPS devices	244
Power storage	246
Accessories	248





# Power supply units and UPS

## Selection guide





### QUINT POWER 1~

				
<b>24 DC / 3.5 A</b> Page 166	<b>24 DC / 5 A</b> Page 166	<b>24 DC / 10 A</b> Page 166 <b>12 DC / 15 A</b> Page 170 <b>48 DC / 5 A</b> Page 170	<b>24 DC / 20 A</b> Page 166 <b>12 DC / 20 A</b> Page 170 <b>48 DC / 10 A</b> Page 170	<b>24 DC / 40 A</b> Page 166 <b>48 DC / 20 A</b> Page 170





### QUINT POWER 3~

			
<b>24 DC / 5 A</b> Page 168	<b>24 DC / 10 A</b> Page 168	<b>24 DC / 20 A</b> Page 168	<b>24 DC / 40 A</b> Page 168 <b>48 DC / 20 A</b> Page 172





### TRIO POWER 1~

			
<b>24 DC / 2.5 A</b> Page 174 <b>12 DC / 5 A</b> Page 178	<b>24 DC / 5 A</b> Page 174 <b>12 DC / 10 A</b> Page 178	<b>24 DC / 10 A</b> Page 174 <b>48 DC / 5 A</b> Page 178	<b>24 DC / 20 A</b> Page 174 <b>48 DC / 10 A</b> Page 178



### TRIO POWER 3~

			
<b>24 DC / 5 A</b> Page 176	<b>24 DC / 10 A</b> Page 176	<b>24 DC / 20 A</b> Page 176	<b>24 DC / 40 A</b> Page 176







### MINI POWER 1~

				
<b>24 DC / 1.3 A</b> Page 180 <b>5 DC / 3 A</b> Page 182	<b>24 DC / 1.5 A</b> Page 180	<b>24 DC / 2 A</b> Page 180 <b>10 - 15 DC / 2 A</b> Page 182 <b>±15 DC / 1 A</b> Page 182	<b>24 DC / 4 A</b> Page 180 <b>24 DC / 100 W</b> Page 180 <b>10 - 15 DC / 8 A</b> Page 182	<b>1 AC / 24 DC / 1.5 A EX</b> Page 194





UNO POWER 1~

		
24 DC / 30 W Page 184 12 DC / 30 W Page 184	24 DC / 60 W Page 184 12 DC / 55 W Page 184	24 DC / 100 W Page 184

STEP POWER 1~

					
24 DC / 0.5 A Page 186 48 AC / 24 DC / 0.5 A Page 186 12 DC / 1 A Page 192 5 DC / 2 A Page 190	24 DC / 0.75 A / FL Page 186 12 DC / 1.5 A / FL Page 192	24 DC / 0.75 A Page 186 12 DC / 1.5 A Page 192	24 DC / 1.75 A Page 188 12 DC / 3 A Page 192	24 DC / 2.5 A Page 188 5 DC / 6.5 A Page 190 12 DC / 5 A Page 192 15 DC / 4 A Page 190	24 DC / 4.2 A Page 188 24 DC / 100 W Page 2868667 48 DC / 2 A Page 190



QUINT POWER, dip-coated 1~, 3~ power supply units

			
1 AC / 24 DC / 5 A CO Page 194	1 AC / 24 DC / 10 A CO Page 194	1 AC / 24 DC / 20 A CO Page 194	3 AC / 24 DC / 20 A CO Page 194



QUINT DC/DC converters

		
24 DC / 24 DC / 5 A / Page 200	24 DC / 24 DC / 10 A / Page 200	24 DC / 24 DC / 20 A / Page 200

QUINT DC/DC converters

		
24 DC / 24 DC / 5 A Page 198 24 DC / 12 DC / 8 A Page 198 48 DC / 24 DC / 5 A Page 200 12 DC / 24 DC / 5 A Page 200	24 DC / 24 DC / 10 A Page 198 24 DC / 48 DC / 5 A Page 198	24 DC / 24 DC / 20 A Page 198





MINI DC/DC converters

	
12 - 24 DC / 24 DC / 1 A Page 202 48 - 60 DC / 24 DC / 1 A Page 202 12 - 24 DC / 5 - 15 DC / 2 A Page 202 12 - 24 D / 48 DC / 0.7 A Page 202	AC power module Page 202

TRIO POWER 600 V

600 DC / 24 DC / 20 A Page 178

Redundancy modules - QUINT

			
24 DC / 2x10 A Page 206	24 DC / 2x20 A Page 206	24 DC / 2x40 Page 206	12 - 24 DC / 2x20 A Page 210 48 DC / 2x20 A Page 210

- TRIO

12 - 24 DC / 2x10 A Page 208 48 DC / 2x10 A Page 208







- STEP

5 - 24 DC / 2x5 A Page 210

# Power supply units and UPS

## Selection guide

### QUINT DC-UPS

					
<b>24 DC / 5 A</b> Page 218	<b>24 DC / 10 A</b> Page 218	<b>24 DC / 20 A</b> Page 218	<b>24 DC / 40 A</b> Page 218	<b>12 DC / 5 / 24 DC / 10</b> Page 220	<b>1 AC / 1 AC / 500 VA</b> Page 221



### UPS-CAP

	
<b>24 DC / 10 A / 10 KJ</b> Page 222	<b>24 DC / 20 A / 20 KJ</b> Page 222

### UPS-BAT/LI-ION

<b>24 DC / 120 WH</b> Page 223





### UPS-BAT/VRLA-WTR

	
<b>24 DC / 13 AH</b> Page 226	<b>24 DC / 26 AH</b> Page 226

### UPS-BAT/VRLA

				
<b>24DC / 1.3AH</b> Page 224	<b>24DC / 3.4AH</b> Page 224	<b>24 DC / 7.2 AH</b> Page 224	<b>24 DC / 12 AH</b> Page 224	<b>24 DC / 38 AH</b> Page 224







### UPS with integrated QUINT, STEP power storage

				
<b>24DC / 5 / 1.3AH</b> Page 230	<b>24DC / 10 / 3.4AH</b> Page 230	<b>24 DC / 3</b> Page 232	<b>12 DC / 4</b> Page 232	<b>24 DC / 40</b> Page 231

### UPS with integrated power supply unit

		
<b>1AC / 24 DC / 2</b> Page 235	<b>1AC / 12 DC / 4</b> Page 235	<b>1 AC / 24 DC / 5</b> Page 234

Power storage for TRIO UPS

					
<b>24 DC / 1.3 AH</b> Page 236	<b>24 DC / 3.4 AH</b> Page 236	<b>24 DC / 7.2 AH</b> Page 236	<b>24 DC / 12 AH</b> Page 236	<b>24 DC / 1.3 AH</b> Page 238 <b>12 DC / 2.6 AH</b> Page 238	<b>24 DC / 0.8 AH</b> Page 238 <b>12 DC / 1.6 AH</b> Page 238

USV-CP

				
<b>1 kVA / 240 AC</b> Page 244	<b>2 kVA / 240 AC</b> Page 244	<b>3 kVA / 240 AC</b> Page 244	<b>4.5 kVA / 240 AC</b> Page 244	<b>6 kVA / 240 AC</b> Page 244

Power storage for USV-CP

				
<b>1 kVA / 19 minutes</b> Page 246 For UPS-CP-1KVA	<b>1 kVA / 36 minutes</b> Page 246 For UPS-CP-1KVA	<b>2/3 kVA / 8 minutes</b> Page 246 For UPS-CP-2KVA <b>2/3 kVA / 5 minutes</b> Page 246 For UPS-CP-3KVA	<b>2/3 kVA / 19 minutes</b> Page 246 For UPS-CP-2KVA <b>2/3 kVA / 12 minutes</b> Page 246 For UPS-CP-3KVA	<b>4.5/6 kVA / 10 minutes</b> Page 246 For UPS-CP-4.5KVA <b>2/3 kVA / 8 minutes</b> Page 246 For UPS-CP-6KVA



### Leading technology and high quality - power supply units ensure your system is always reliably supplied with power.

Thanks to high-quality products featuring leading technology, with our power supply solutions from the QUINT, TRIO, MINI, and STEP product ranges, you are optimally equipped to handle competitors on an international scale.

Functionality, performance class, and design are tailored to the demands of various different sectors and always offer the ideal solution. Choose from our wide range of power supply units and DC/DC converters.

### QUINT POWER for maximum system availability

Cost-effective selective fuse protection with SFB technology:

In order to trip standard circuit breakers magnetically and quickly, power supply units must be able to supply several times the nominal current for a short period. With SFB (Selective Fuse Breaking) technology, which supplies up to 6 times the nominal current for 12 ms, a dynamic power reserve is available. Faulty current paths are selectively switched off, the fault is isolated, and important system components remain operational.

#### Preventive function monitoring:

Comprehensive diagnostics are provided through constant monitoring of the output voltage and output current. This preventive function monitoring visualizes critical operating states, before errors can occur. The remote monitoring takes place by means of active switching outputs and floating relay contacts.

#### POWER BOOST power reserve:

The static power reserve offers up to 1.5 times the nominal current permanently. At ambient temperatures of up to +40°C the POWER BOOST is continuously available and at higher temperatures, it is available for a few minutes. This ensures that both high inrush currents of capacitive loads, as well as loads with DC/DC converters in the primary circuit, can be reliably supplied.



**Power supply units - a comparison of the advantages**

Choose the range of power supply units that best suits your requirements based on ① functionality and ② power.



**QUINT POWER – power supply units for maximum system availability**

The unique SFB technology and preventive function monitoring maximize the availability of your application.

- Quick tripping of the standard power circuit breakers
- Preventive function monitoring
- Reliable starting of heavy loads



**TRIO POWER - basic functionality at the highest level**

Basic functionality combined with high quality and reliability - this makes the power supply units ideal for use in standard machine production.

- Robust design
- Minimize installation costs
- High operational reliability



**UNO POWER - compact basic functionality**

The UNO POWER power supply units offer extremely compact basic functionality.

- Save energy thanks to high efficiency and low idling losses
- Wide-range input
- Wide temperature range



**MINI POWER - for measurement and control technology**

The MINI POWER comes into its own in fields where modular electronics housing has become the standard.

- Service-friendly connection technology: encoded COMBICON plug-in connectors
- Active function monitoring with switching output for remote monitoring of the output voltage



**STEP POWER - for installation distributors and flat control panels**

The low idling losses and high efficiency make the STEP POWER the most energy efficient in its class.

- Flexible: snap onto the DIN rail or screw onto a level surface
- Energy savings: maximum energy efficiency and incredibly low idling losses

# Power supply units and UPS

## Power supply units

### QUINT POWER power supply units – for maximum system availability

- Quick tripping of standard circuit breakers thanks to the dynamic power reserve SFB (selective fuse breaking) technology with up to 6x the nominal current for 12 ms
- Reliable starting of heavy loads with the static POWER BOOST power reserve with permanently up to 1.5 times the nominal current
- Preventive function monitoring warns against critical operating states before errors occur
- Approved according to SEMI F47: all 24 V DC

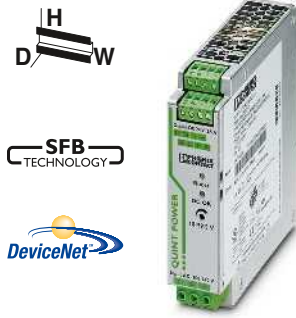

Power supply,  
1 AC, 24 V DC, 3.5 A

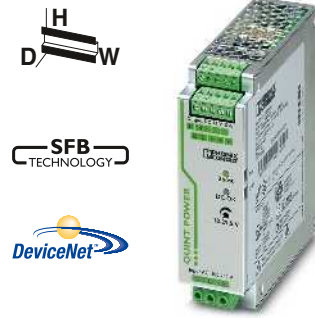

Power supply,  
1 AC, 24 V DC, 5 A

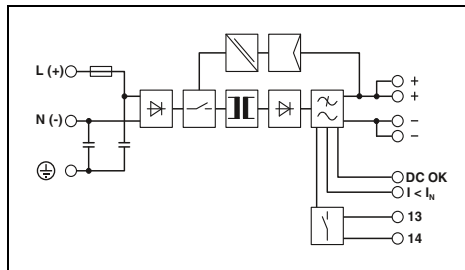

#### Technical data

Input data	100 V AC ... 240 V AC 85 V AC ... 264 V AC / 90 V DC ... 350 V DC 45 Hz ... 65 Hz / 0 Hz 1.4 A (120 V AC) / 0.8 A (230 V AC) < 20 A / < 2 A <sup>2</sup> s > 20 ms (120 V AC) / > 80 ms (230 V AC)
Output data	24 V DC ±1% 18 V DC ... 29.5 V DC (> 24 V constant capacity)
Output current / POWER BOOST / SFB (12 ms) Magnetic fuse tripping	3.5 A / 4 A / 15 A B2
Can be connected in parallel / series	Yes / Yes
Max. power dissipation (no load / nominal load)	3.5 W / 11 W
Efficiency (typ.)	> 88 % (for 230 V AC and nominal values)
Residual ripple	< 50 mV <sub>pp</sub>
Signaling	LED, active switching output, relay contact
Signaling DC OK	LED, active switching output
Boost signaling	
General data	
Weight / Dimensions W x H x D	0.5 kg / 32 x 130 x 125 mm
Spacing when mounting	Alignable: 5 mm horizontally, 15 mm next to active components, 50 mm vertically
Connection method	Plug-in screw connection
Input connection data (solid/stranded/AWG)	0.2 - 2.5 mm <sup>2</sup> / 0.2 - 2.5 mm <sup>2</sup> / 20 - 12
Output connection data (solid/stranded/AWG)	0.2 - 2.5 mm <sup>2</sup> / 0.2 - 2.5 mm <sup>2</sup> / 20 - 12
Signal connection data (solid/stranded/AWG)	0.2 - 2.5 mm <sup>2</sup> / 0.2 - 2.5 mm <sup>2</sup> / 20 - 12
Degree of protection / Protection class	IP20 / I
MTBF (EN 29500, 40°C)	> 820000 h
Ambient temperature (operation)	-25 °C ... 70 °C (> 60 °C derating)
Standards/regulations	
Insulation voltage input/output	2 kV AC (routine test) / 4 kV AC (type test)
Electromagnetic compatibility	Conformance with EMC Directive 2004/108/EC
Electrical safety	IEC 60950-1/VDE 0805 (SELV)
Electronic equipm. for electrical power installations	EN 50178/VDE 0160 (PELV)
Safe isolation	DIN VDE 0100-410, DIN VDE 0106-1010
Medical standard	IEC 60601
UL approvals	UL Listed UL 508, UL/C-UL Recognized UL 60950, UL ANSI/ISA-12.12.01 Class I, Division 2, Groups A, B, C, D (Hazardous Location)
Limitation of harmonic line currents	EN 61000-3-2

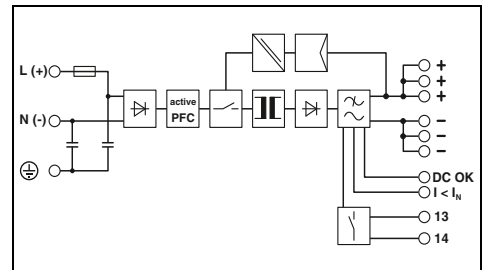

#### Technical data

Input data	100 V AC ... 240 V AC 85 V AC ... 264 V AC / 90 V DC ... 350 V DC 45 Hz ... 65 Hz / 0 Hz 1.2 A (120 V AC) / 0.6 A (230 V AC) < 15 A / < 1 A <sup>2</sup> s > 30 ms (120 V AC) / > 30 ms (230 V AC)
Output data	24 V DC ±1% 18 V DC ... 29.5 V DC (> 24 V constant capacity)
Output current / POWER BOOST / SFB (12 ms) Magnetic fuse tripping	5 A / 7.5 A / 30 A B2, B4, C2
Can be connected in parallel / series	Yes / Yes
Max. power dissipation (no load / nominal load)	3 W / 15 W
Efficiency (typ.)	> 90 % (for 230 V AC and nominal values)
Residual ripple	< 40 mV <sub>pp</sub>
Signaling	LED, active switching output, relay contact
Signaling DC OK	LED, active switching output
Boost signaling	
General data	
Weight / Dimensions W x H x D	0.7 kg / 40 x 130 x 125 mm
Spacing when mounting	Alignable: 5 mm horizontally, 15 mm next to active components, 50 mm vertically
Connection method	Plug-in screw connection
Input connection data (solid/stranded/AWG)	0.2 - 2.5 mm <sup>2</sup> / 0.2 - 2.5 mm <sup>2</sup> / 20 - 12
Output connection data (solid/stranded/AWG)	0.2 - 2.5 mm <sup>2</sup> / 0.2 - 2.5 mm <sup>2</sup> / 20 - 12
Signal connection data (solid/stranded/AWG)	0.2 - 2.5 mm <sup>2</sup> / 0.2 - 2.5 mm <sup>2</sup> / 20 - 12
Degree of protection / Protection class	IP20 / I
MTBF (EN 29500, 40°C)	> 635000 h
Ambient temperature (operation)	-25 °C ... 70 °C (> 60 °C derating, startup at -40 °C type-tested)
Standards/regulations	
Insulation voltage input/output	2 kV AC (routine test) / 4 kV AC (type test)
Electromagnetic compatibility	Conformance with EMC Directive 2004/108/EC
Electrical safety	IEC 60950-1/VDE 0805 (SELV)
Electronic equipm. for electrical power installations	EN 50178/VDE 0160 (PELV)
Safe isolation	DIN VDE 0100-410, DIN VDE 0106-1010
Medical standard	IEC 60601
UL approvals	UL Listed UL 508, UL/C-UL Recognized UL 60950, UL ANSI/ISA-12.12.01 Class I, Division 2, Groups A, B, C, D (Hazardous Location)
Limitation of harmonic line currents	EN 61000-3-2

#### Ordering data

Description	Type	Order No.	Pcs. / Pkt.
Power supply unit, primary-switched	QUINT-PS/ 1AC/24DC/ 3.5	2866747	1

#### Ordering data

Description	Type	Order No.	Pcs. / Pkt.
Power supply unit, primary-switched	QUINT-PS/ 1AC/24DC/ 5	2866750	1



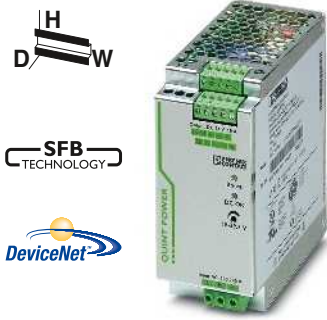

Power supply,  
1 AC, 24 V DC, 10 A



Power supply,  
1 AC, 24 V DC, 20 A



Power supply,  
1 AC, 24 V DC, 40 A

UL, ABS, BSH, ClassNK, CB, Ex

UL, ABS, BSH, ClassNK, CB, Ex

UL, ABS, BSH, ClassNK, BV-CPS, CB, Ex

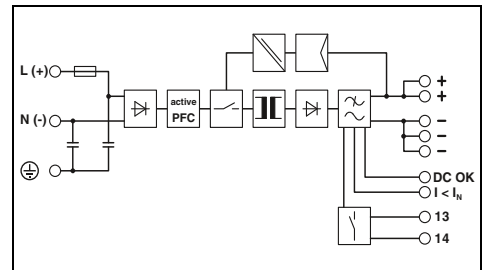
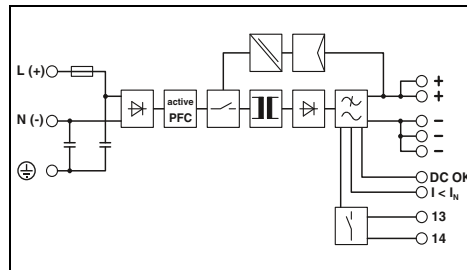
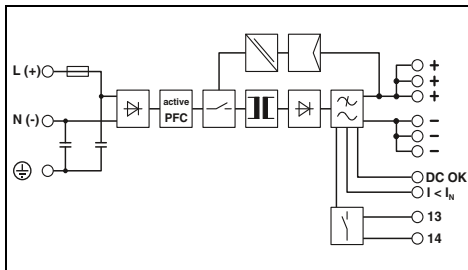

Technical data

100 V AC ... 240 V AC  
85 V AC ... 264 V AC / 90 V DC ... 350 V DC  
45 Hz ... 65 Hz / 0 Hz  
2.24 A (120 V AC) / 1.33 A (230 V AC)  
< 15 A / < 1.5 A<sup>2</sup>s  
> 32 ms (120 V AC) / > 36 ms (230 V AC)

24 V DC ±1%  
18 V DC ... 29.5 V DC (> 24 V constant capacity)

10 A / 15 A / 60 A  
B2, B4, B6, C2, C4

Yes / Yes  
9.1 W / 22 W  
> 92.5 % (for 230 V AC and nominal values)  
< 50 mV<sub>pp</sub>

LED, active switching output, relay contact  
LED, active switching output

1.1 kg / 60 x 130 x 125 mm  
Alignable: 5 mm horizontally, 15 mm next to active components, 50 mm vertically  
Plug-in screw connection  
0.2 - 2.5 mm<sup>2</sup> / 0.2 - 2.5 mm<sup>2</sup> / 16 - 12  
0.2 - 2.5 mm<sup>2</sup> / 0.2 - 2.5 mm<sup>2</sup> / 16 - 12  
0.2 - 2.5 mm<sup>2</sup> / 0.2 - 2.5 mm<sup>2</sup> / 16 - 12  
IP20 / I  
> 535000 h  
> 25 °C ... 70 °C (> 60 °C derating, startup at -40 °C type-tested)

2 kV AC (routine test) / 4 kV AC (type test)  
Conformance with EMC Directive 2004/108/EC  
IEC 60950-1/VDE 0805 (SELV)  
EN 50178/VDE 0160 (PELV)  
DIN VDE 0100-410, DIN VDE 0106-1010  
IEC 60601  
UL Listed UL 508, UL/C-UL Recognized UL 60950, UL ANSI/ISA-12.12.01 Class I, Division 2, Groups A, B, C, D (Hazardous Location)  
EN 61000-3-2

Technical data

100 V AC ... 240 V AC  
85 V AC ... 264 V AC / 90 V DC ... 350 V DC  
45 Hz ... 65 Hz / 0 Hz  
5.1 A (120 V AC) / 2.3 A (230 V AC)  
< 20 A / < 3.2 A<sup>2</sup>s  
> 20 ms (120 V AC) / > 20 ms (230 V AC)

24 V DC ±1%  
18 V DC ... 29.5 V DC (> 24 V constant capacity)

20 A / 26 A / 120 A  
B2, B4, B6, B10, B16, C2, C4, C6

Yes / Yes  
8 W / 40 W  
> 93 % (for 230 V AC and nominal values)  
< 30 mV<sub>pp</sub>

LED, active switching output, relay contact  
LED, active switching output

1.7 kg / 90 x 130 x 125 mm  
Alignable: 5 mm horizontally, 15 mm next to active components, 50 mm vertically  
Screw connection  
0.2 - 6 mm<sup>2</sup> / 0.2 - 4 mm<sup>2</sup> / 18 - 10  
0.2 - 6 mm<sup>2</sup> / 0.2 - 4 mm<sup>2</sup> / 12 - 10  
0.2 - 6 mm<sup>2</sup> / 0.2 - 4 mm<sup>2</sup> / 18 - 10  
IP20 / I  
> 520000 h  
> 25 °C ... 70 °C (> 60 °C derating, startup at -40 °C type-tested)

2 kV AC (routine test) / 4 kV AC (type test)  
Conformance with EMC Directive 2004/108/EC  
IEC 60950-1/VDE 0805 (SELV)  
EN 50178/VDE 0160 (PELV)  
DIN VDE 0100-410, DIN VDE 0106-1010  
IEC 60601  
UL Listed UL 508, UL/C-UL Recognized UL 60950, UL ANSI/ISA-12.12.01 Class I, Division 2, Groups A, B, C, D (Hazardous Location)  
EN 61000-3-2

Technical data

100 V AC ... 240 V AC  
85 V AC ... 264 V AC / 90 V DC ... 300 V DC  
45 Hz ... 65 Hz / 0 Hz  
8.8 A (120 V AC) / 4.6 A (230 V AC)  
< 15 A / < 1.7 A<sup>2</sup>s  
> 20 ms (120 V AC) / > 20 ms (230 V AC)

24 V DC ±1%  
18 V DC ... 29.5 V DC (> 24 V constant capacity)

40 A / 45 A / 215 A  
B2, B4, B6, B10, B16, B25, C2, C4, C6, C13

Yes / Yes  
14 W / 80 W  
> 92 % (for 230 V AC and nominal values)  
< 30 mV<sub>pp</sub>

LED, active switching output, relay contact  
LED, active switching output

3.3 kg / 180 x 130 x 125 mm  
Alignable: 5 mm horizontally, 15 mm next to active components, 50 mm vertically  
Screw connection  
0.2 - 6 mm<sup>2</sup> / 0.2 - 4 mm<sup>2</sup> / 14 - 10  
0.5 - 16 mm<sup>2</sup> / 0.5 - 16 mm<sup>2</sup> / 8 - 6  
0.2 - 6 mm<sup>2</sup> / 0.2 - 4 mm<sup>2</sup> / 24 - 10  
IP20 / I  
> 530000 h  
> 25 °C ... 70 °C (> 60 °C derating, startup at -40 °C type-tested)

2 kV AC (routine test) / 4 kV AC (type test)  
Conformance with EMC Directive 2004/108/EC  
IEC 60950-1/VDE 0805 (SELV)  
EN 50178/VDE 0160 (PELV)  
DIN VDE 0100-410, DIN VDE 0106-1010  
-  
UL Listed UL 508, UL/C-UL Recognized UL 60950, UL ANSI/ISA-12.12.01 Class I, Division 2, Groups A, B, C, D (Hazardous Location)  
EN 61000-3-2

Ordering data

Type	Order No.	Pcs. / Pkt.
QUINT-PS/ 1AC/24DC/10	2866763	1

Ordering data

Type	Order No.	Pcs. / Pkt.
QUINT-PS/ 1AC/24DC/20	2866776	1

Ordering data

Type	Order No.	Pcs. / Pkt.
QUINT-PS/ 1AC/24DC/40	2866789	1

# Power supply units and UPS

## Power supply units

### QUINT POWER power supply units – for maximum system availability

#### QUINT POWER, 3 AC, 24 V DC

- High system availability even in the event of a permanent phase failure
- High surge strength of up to 6 kV thanks to integrated gas-filled arresters
- Quick tripping of standard circuit breakers thanks to the dynamic power reserve SFB (selective fuse breaking) technology with up to 6x the nominal current for 12 ms
- Reliable starting of heavy loads with the static POWER BOOST power reserve with permanently up to 1.5 times the nominal current
- Preventive function monitoring warns against critical operating states before errors occur
- Approved according to SEMI F47: all 24 V DC



Power supply,  
3 AC, 24 V DC, 5 A

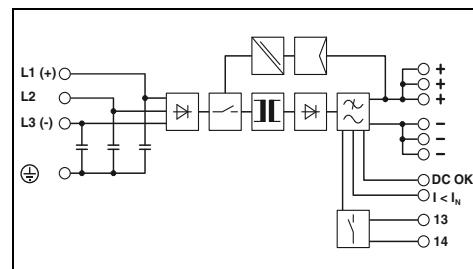

#### Technical data

<b>Input data</b>	Nominal input voltage range Input voltage range AC/DC Frequency range Current consumption (nominal load) Inrush current limitation at 25°C (typ.) / I <sup>2</sup> t Mains buffering (I <sub>N</sub> , typ.)	3x 400 V AC ... 500 V AC 320 V AC ... 575 V AC / 450 V DC ... 800 V DC 45 Hz ... 65 Hz / 0 Hz 3x 0.8 A (400 V AC) / 3x 0.7 A (500 V AC) < 15 A / < 1 A <sup>2</sup> s > 20 ms (400 V AC) / > 30 ms (500 V AC)
<b>Output data</b>	Nominal output voltage Setting range of the output voltage  Output current / POWER BOOST / SFB (12 ms) Magnetic fuse tripping	24 V DC ±1% 18 V DC ... 29.5 V DC (> 24 V constant capacity)  5 A / 7.5 A / 30 A B2, B4, C2
Can be connected in parallel / series Max. power dissipation (no load / nominal load) Efficiency (typ.) Residual ripple	Yes / Yes 4 W / 14 W > 89 % (at 400 V AC and nominal values) < 20 mV <sub>PP</sub>	
<b>Signaling</b>	Signaling DC OK Boost signaling	LED, active switching output, relay contact LED, active switching output
<b>General data</b>	Weight / Dimensions W x H x D Spacing when mounting  Connection method Input connection data (solid/stranded/AWG) Output connection data (solid/stranded/AWG) Signal connection data (solid/stranded/AWG) Degree of protection / Protection class MTBF (EN 29500, 40°C) Ambient temperature (operation)	0.7 kg / 40 x 130 x 125 mm Alignable: 5 mm horizontally, 15 mm next to active components, 50 mm vertically Plug-in screw connection 0.2 - 2.5 mm <sup>2</sup> / 0.2 - 2.5 mm <sup>2</sup> / 20 - 12 0.2 - 2.5 mm <sup>2</sup> / 0.2 - 2.5 mm <sup>2</sup> / 20 - 12 0.2 - 2.5 mm <sup>2</sup> / 0.2 - 2.5 mm <sup>2</sup> / 20 - 12 IP20 / I > 635000 h -25 °C ... 70 °C (> 60°C derating, startup at -40°C type-tested)
<b>Standards/regulations</b>	Insulation voltage input/output Electromagnetic compatibility Electrical safety Electronic equipm. for electrical power installations Safe isolation UL approvals	2 kV AC (routine test) / 4 kV AC (type test) Conformance with EMC Directive 2004/108/EC IEC 60950-1/VDE 0805 (SELV) EN 50178/VDE 0160 (PELV) DIN VDE 0100-410, DIN VDE 0106-1010 UL Listed UL 508, UL/C-UL Recognized UL 60950 (3-wire + PE, star net), UL ANSI/ISA-12.12.01 Class I, Division 2, Groups A, B, C, D (Hazardous Location)
Limitation of harmonic line currents	EN 61000-3-2	

#### Ordering data

Description	Type	Order No.	Pcs. / Pkt.
Power supply unit, primary-switched	QUINT-PS/3AC/24DC/5	2866734	1

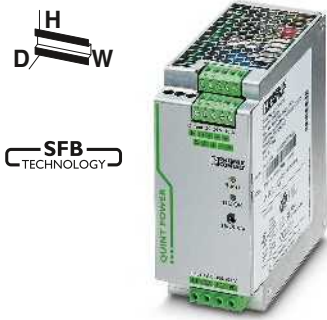

**Power supply,  
3 AC, 24 V DC, 10 A**



**Power supply,  
3 AC, 24 V DC, 20 A**



**Power supply,  
3 AC, 24 V DC, 40 A**

UL US PC UL ABS BSH B R ClassNK CB Ex: (U)

UL US PC UL ABS BSH B R ClassNK CB Ex: (U)

UL US PC UL ABS BSH B R ClassNK CB Ex: (U)

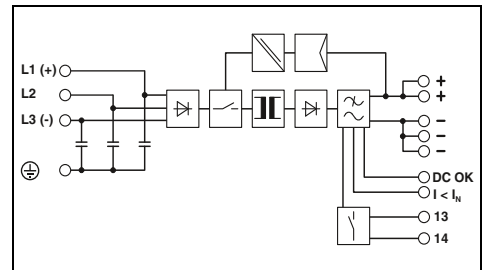
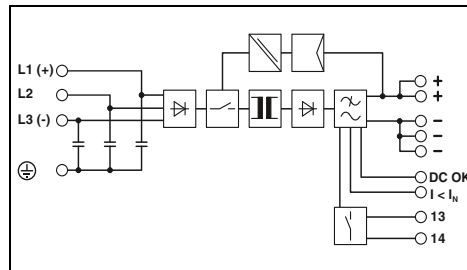
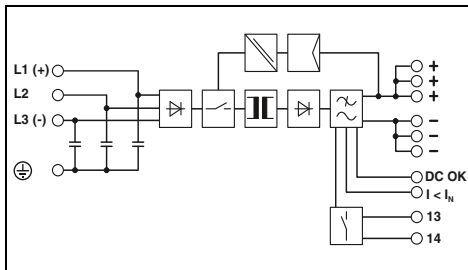

### Technical data

3x 400 V AC ... 500 V AC  
320 V AC ... 575 V AC / 450 V DC ... 800 V DC  
45 Hz ... 65 Hz / 0 Hz  
3x 1.2 A (400 V AC) / 3x 1 A (500 V AC)  
< 15 A / < 1.5 A<sup>2</sup>s  
> 20 ms (400 V AC) / > 30 ms (500 V AC)

24 V DC ±1%  
18 V DC ... 29.5 V DC (> 24 V constant capacity)

10 A / 15 A / 60 A  
B2, B4, B6, C2, C4

Yes / Yes  
7 W / 19 W  
> 93 % (at 400 V AC and nominal values)  
< 20 mV<sub>pp</sub>

LED, active switching output, relay contact  
LED, active switching output

1.1 kg / 60 x 130 x 125 mm  
Alignable: 5 mm horizontally, 15 mm next to active components, 50 mm vertically  
Plug-in screw connection  
0.2 - 2.5 mm<sup>2</sup> / 0.2 - 2.5 mm<sup>2</sup> / 16 - 12  
0.2 - 2.5 mm<sup>2</sup> / 0.2 - 2.5 mm<sup>2</sup> / 16 - 12  
0.2 - 2.5 mm<sup>2</sup> / 0.2 - 2.5 mm<sup>2</sup> / 16 - 12  
IP20 / I  
> 633000 h  
> 25 °C ... 70 °C (> 60 °C derating, startup at -40 °C type-tested)

2 kV AC (routine test) / 4 kV AC (type test)  
Conformance with EMC Directive 2004/108/EC  
IEC 60950-1/VDE 0805 (SELV)  
EN 50178/VDE 0160 (PELV)  
DIN VDE 0100-410, DIN VDE 0106-1010  
UL Listed UL 508, UL/C-UL Recognized UL 60950 (3-wire + PE, star net), UL ANSI/ISA-12.12.01 Class I, Division 2, Groups A, B, C, D (Hazardous Location)

EN 61000-3-2

### Ordering data

Type	Order No.	Pcs. / Pkt.
QUINT-PS/ 3AC/24DC/10	2866705	1

### Technical data

3x 400 V AC ... 500 V AC  
320 V AC ... 575 V AC / 450 V DC ... 800 V DC  
45 Hz ... 65 Hz / 0 Hz  
3x 1.6 A (400 V AC) / 3x 1.3 A (500 V AC)  
< 20 A / < 3.2 A<sup>2</sup>s  
> 20 ms (400 V AC) / > 30 ms (500 V AC)

24 V DC ±1%  
18 V DC ... 29.5 V DC (> 24 V constant capacity)

20 A / 26 A / 120 A  
B2, B4, B6, B10, B16, C2, C4, C6

Yes / Yes  
11 W / 40 W  
> 93 % (at 400 V AC and nominal values)  
< 40 mV<sub>pp</sub>

LED, active switching output, relay contact  
LED, active switching output

1.5 kg / 69 x 130 x 125 mm  
Alignable: 5 mm horizontally, 15 mm next to active components, 50 mm vertically  
Screw connection  
0.2 - 6 mm<sup>2</sup> / 0.2 - 4 mm<sup>2</sup> / 18 - 10  
0.2 - 6 mm<sup>2</sup> / 0.2 - 4 mm<sup>2</sup> / 12 - 10  
0.2 - 6 mm<sup>2</sup> / 0.2 - 4 mm<sup>2</sup> / 18 - 10  
IP20 / I  
> 534000 h  
> 25 °C ... 70 °C (> 60 °C derating, startup at -40 °C type-tested)

2 kV AC (routine test) / 4 kV AC (type test)  
Conformance with EMC Directive 2004/108/EC  
IEC 60950-1/VDE 0805 (SELV)  
EN 50178/VDE 0160 (PELV)  
DIN VDE 0100-410, DIN VDE 0106-1010  
UL Listed UL 508, UL/C-UL Recognized UL 60950 (3-wire + PE, star net), UL ANSI/ISA-12.12.01 Class I, Division 2, Groups A, B, C, D (Hazardous Location)

EN 61000-3-2

### Ordering data

Type	Order No.	Pcs. / Pkt.
QUINT-PS/ 3AC/24DC/20	2866792	1

### Technical data

3x 400 V AC ... 500 V AC  
320 V AC ... 575 V AC / 450 V DC ... 800 V DC  
45 Hz ... 65 Hz / 0 Hz  
3x 2.1 A (400 V AC) / 3x 1.7 A (500 V AC)  
< 20 A / < 1 A<sup>2</sup>s  
> 25 ms (400 V AC) / > 35 ms (500 V AC)

24 V DC ±1%  
18 V DC ... 29.5 V DC (> 24 V constant capacity)

40 A / 45 A / 215 A  
B2, B4, B6, B10, B16, B25, C2, C4, C6, C13

Yes / Yes  
18 W / 63 W  
> 94 % (at 400 V AC and nominal values)  
< 40 mV<sub>pp</sub>

LED, active switching output, relay contact  
LED, active switching output

2.5 kg / 96 x 130 x 176 mm  
Alignable: 5 mm horizontally, 15 mm next to active components, 50 mm vertically  
Screw connection  
0.2 - 6 mm<sup>2</sup> / 0.2 - 4 mm<sup>2</sup> / 18 - 10  
0.5 - 16 mm<sup>2</sup> / 0.5 - 16 mm<sup>2</sup> / 8 - 6  
0.2 - 6 mm<sup>2</sup> / 0.2 - 4 mm<sup>2</sup> / 18 - 10  
IP20 / I  
> 501000 h  
> 25 °C ... 70 °C (> 60 °C derating, startup at -40 °C type-tested)

2 kV AC (routine test) / 4 kV AC (type test)  
Conformance with EMC Directive 2004/108/EC  
IEC 60950-1/VDE 0805 (SELV)  
EN 50178/VDE 0160 (PELV)  
DIN VDE 0100-410, DIN VDE 0106-1010  
UL Listed UL 508, UL/C-UL Recognized UL 60950 (3-wire + PE, star net), UL ANSI/ISA-12.12.01 Class I, Division 2, Groups A, B, C, D (Hazardous Location)

EN 61000-3-2

### Ordering data

Type	Order No.	Pcs. / Pkt.
QUINT-PS/ 3AC/24DC/40	2866802	1

# Power supply units and UPS

## Power supply units

### QUINT POWER power supply units – for maximum system availability

#### QUINT POWER, 1 AC, 12 and 48 V DC

- Quick tripping of the standard power circuit breakers
- Reliable starting of heavy loads
- Preventive function monitoring
- Approved according to SEMI F47: 12 V DC, 15 A A and 20 A, 48 V DC, 5 A and 10 A
- Adjustable output voltage of 5 to 18 V DC, or 30 to 56 V DC

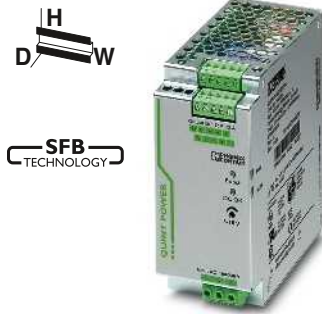

Power supply,  
1 AC, 12 V DC, 15 A

SF c UL15 PFC UL CB CB0000 POK  
Ex: (UL)

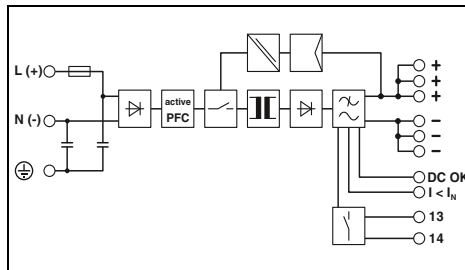

#### Technical data

Input data	
Nominal input voltage range	100 V AC ... 240 V AC
Input voltage range AC/DC	85 V AC ... 264 V AC / 90 V DC ... 350 V DC
Frequency range	45 Hz ... 65 Hz / 0 Hz
Current consumption (nominal load)	1.9 A (120 V AC) / 0.9 A (230 V AC)
Inrush current limitation at 25°C (typ.) / I <sup>2</sup> t	< 15 A / < 1.5 A <sup>2</sup> s
Mains buffering (I <sub>N</sub> , typ.)	> 65 ms (120 V AC) / > 65 ms (230 V AC)
Output data	
Nominal output voltage	12 V DC ±1%
Setting range of the output voltage	5 V DC ... 18 V DC (> 12 V constant capacity)
Output current / POWER BOOST / SFB (12 ms)	15 A / 16 A / 60 A
Magnetic fuse tripping	B2, B4, B6, C2, C4
Can be connected in parallel / series	Yes / Yes
Max. power dissipation (no load / nominal load)	5 W / 21 W
Efficiency (typ.)	> 89 % (for 230 V AC and nominal values)
Residual ripple	< 10 mV <sub>pp</sub>
Signaling	
Signaling DC OK	LED, active switching output, relay contact
Boost signaling	LED, active switching output
General data	
Weight / Dimensions W x H x D	1.1 kg / 60 x 130 x 125 mm
Spacing when mounting	Alignable: 5 mm horizontally, 15 mm next to active components, 50 mm vertically
Connection method	Plug-in screw connection
Input connection data (solid/stranded/AWG)	0.2 - 2.5 mm <sup>2</sup> / 0.2 - 2.5 mm <sup>2</sup> / 16 - 12
Output connection data (solid/stranded/AWG)	0.2 - 2.5 mm <sup>2</sup> / 0.2 - 2.5 mm <sup>2</sup> / 16 - 12
Signal connection data (solid/stranded/AWG)	0.2 - 2.5 mm <sup>2</sup> / 0.2 - 2.5 mm <sup>2</sup> / 16 - 12
Degree of protection / Protection class	IP20 / I
MTBF (EN 29500, 40°C)	> 570000 h
Ambient temperature (operation)	-25 °C ... 70 °C (> 60°C derating, startup at -40°C type-tested)
Standards/regulations	
Insulation voltage input/output	2 kV AC (routine test) / 4 kV AC (type test)
Electromagnetic compatibility	Conformance with EMC Directive 2004/108/EC
Electrical safety	IEC 60950-1/VDE 0805 (SELV)
Electronic eqpm. for electrical power installations	EN 50178/VDE 0160 (PELV)
Safe isolation	DIN VDE 0100-410, DIN VDE 0106-1010
Medical standard	IEC 60601
UL approvals	UL Listed UL 508, UL/C-UL Recognized UL 60950, UL ANSI/ISA-12.12.01 Class I, Division 2, Groups A, B, C, D (Hazardous Location)
Limitation of harmonic line currents	EN 61000-3-2



Power supply,  
1 AC, 12 V DC, 20 A

SF c UL15 PFC UL CB CB0000 POK  
Ex: (UL)

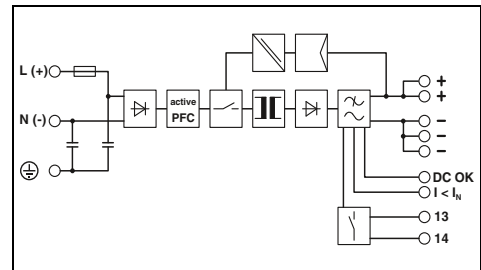

#### Technical data

Input data	
Nominal input voltage range	100 V AC ... 240 V AC
Input voltage range AC/DC	85 V AC ... 264 V AC / 90 V DC ... 350 V DC
Frequency range	45 Hz ... 65 Hz / 0 Hz
Current consumption (nominal load)	2.4 A (120 V AC) / 1.4 A (230 V AC)
Inrush current limitation at 25°C (typ.) / I <sup>2</sup> t	< 20 A / < 3.2 A <sup>2</sup> s
Mains buffering (I <sub>N</sub> , typ.)	> 40 ms (120 V AC) / > 40 ms (230 V AC)
Output data	
Nominal output voltage	12 V DC ±1%
Setting range of the output voltage	5 V DC ... 18 V DC (> 12 V constant capacity)
Output current / POWER BOOST / SFB (12 ms)	20 A / 26 A / 120 A
Magnetic fuse tripping	B2, B4, B6, B10, C2, C4, C6
Can be connected in parallel / series	Yes / Yes
Max. power dissipation (no load / nominal load)	6 W / 29 W
Efficiency (typ.)	> 90 % (for 230 V AC and nominal values)
Residual ripple	< 50 mV <sub>pp</sub>
Signaling	
Signaling DC OK	LED, active switching output, relay contact
Boost signaling	LED, active switching output
General data	
Weight / Dimensions W x H x D	1.5 kg / 90 x 130 x 125 mm
Spacing when mounting	Alignable: 5 mm horizontally, 15 mm next to active components, 50 mm vertically
Connection method	Screw connection
Input connection data (solid/stranded/AWG)	0.2 - 6 mm <sup>2</sup> / 0.2 - 4 mm <sup>2</sup> / 18 - 10
Output connection data (solid/stranded/AWG)	0.2 - 6 mm <sup>2</sup> / 0.2 - 4 mm <sup>2</sup> / 18 - 10
Signal connection data (solid/stranded/AWG)	0.2 - 6 mm <sup>2</sup> / 0.2 - 4 mm <sup>2</sup> / 18 - 10
Degree of protection / Protection class	IP20 / I
MTBF (EN 29500, 40°C)	> 600000 h
Ambient temperature (operation)	-25 °C ... 70 °C (> 60°C derating, startup at -40°C type-tested)
Standards/regulations	
Insulation voltage input/output	2 kV AC (routine test) / 4 kV AC (type test)
Electromagnetic compatibility	Conformance with EMC Directive 2004/108/EC
Electrical safety	IEC 60950-1/VDE 0805 (SELV)
Electronic eqpm. for electrical power installations	EN 50178/VDE 0160 (PELV)
Safe isolation	DIN VDE 0100-410, DIN VDE 0106-1010
Medical standard	IEC 60601
UL approvals	UL Listed UL 508, UL/C-UL Recognized UL 60950, UL ANSI/ISA-12.12.01 Class I, Division 2, Groups A, B, C, D (Hazardous Location)
Limitation of harmonic line currents	EN 61000-3-2

#### Ordering data

Description	Type	Order No.	Pcs. / Pkt.
Power supply unit, primary-switched	QUINT-PS/ 1AC/12DC/15	2866718	1

#### Ordering data

Description	Type	Order No.	Pcs. / Pkt.
Power supply unit, primary-switched	QUINT-PS/ 1AC/12DC/20	2866721	1

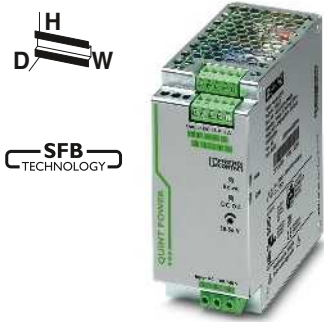

Power supply,  
1 AC, 48 V DC, 5 A



Power supply,  
1 AC, 48 V DC, 10 A



Power supply,  
1 AC, 48 V DC, 20 A

UL, CE, CB, RoHS  
Ex:

UL, CE, CB, RoHS  
Ex:

UL, CE, CB, RoHS  
Ex:

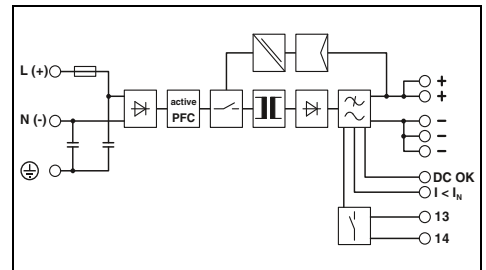
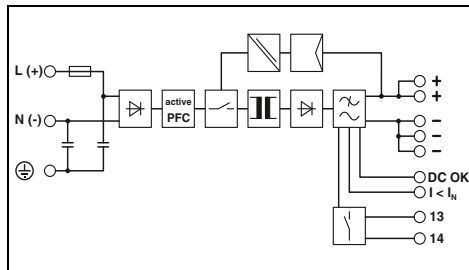
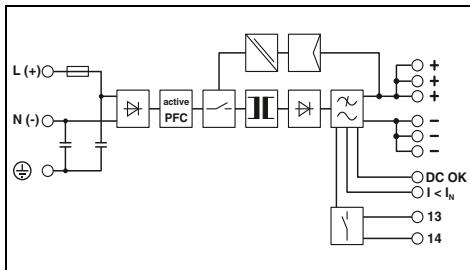

Technical data

100 V AC ... 240 V AC  
85 V AC ... 264 V AC / 90 V DC ... 350 V DC  
45 Hz ... 65 Hz / 0 Hz  
2.8 A (120 V AC) / 1.2 A (230 V AC)  
< 15 A / < 1.5 A<sup>2</sup>s  
> 40 ms (120 V AC) / > 40 ms (230 V AC)

48 V DC ±1%  
30 V DC ... 56 V DC (> 48 V constant capacity)

5 A / 7.5 A / 30 A  
B2, B4, C2  
Yes / Yes  
7 W / 21 W  
> 92.5 % (for 230 V AC and nominal values)  
< 50 mV<sub>pp</sub>

LED, active switching output, relay contact  
LED, active switching output

1.1 kg / 60 x 130 x 125 mm  
Alignable: 5 mm horizontally, 15 mm next to active components, 50 mm vertically  
Plug-in screw connection  
0.2 - 2.5 mm<sup>2</sup> / 0.2 - 2.5 mm<sup>2</sup> / 16 - 12  
0.2 - 2.5 mm<sup>2</sup> / 0.2 - 2.5 mm<sup>2</sup> / 16 - 12  
0.2 - 2.5 mm<sup>2</sup> / 0.2 - 2.5 mm<sup>2</sup> / 16 - 12  
IP20 / I  
> 535000 h  
> 25 °C ... 70 °C (> 60 °C derating, startup at -40 °C type-tested)

2 kV AC (routine test) / 4 kV AC (type test)  
Conformance with EMC Directive 2004/108/EC  
IEC 60950-1/VDE 0805 (SELV)  
EN 50178/VDE 0160 (PELV)  
DIN VDE 0100-410, DIN VDE 0106-1010  
IEC 60601  
UL Listed UL 508, UL/C-UL Recognized UL 60950,  
UL ANSI/ISA-12.12.01 Class I, Division 2, Groups A, B, C, D  
(Hazardous Location)  
EN 61000-3-2

Ordering data

Type	Order No.	Pcs. / Pkt.
QUINT-PS/ 1AC/48DC/ 5	2866679	1

Technical data

100 V AC ... 240 V AC  
85 V AC ... 264 V AC / 90 V DC ... 350 V DC  
45 Hz ... 65 Hz / 0 Hz  
5.1 A (120 V AC) / 2.3 A (230 V AC)  
< 20 A / < 3.2 A<sup>2</sup>s  
> 20 ms (120 V AC) / > 20 ms (230 V AC)

48 V DC ±1%  
30 V DC ... 56 V DC (> 48 V constant capacity)

10 A / 13 A / 60 A  
B2, B4, B6, C2, C4  
Yes / Yes  
16 W / 41 W  
> 93 % (for 230 V AC and nominal values)  
< 80 mV<sub>pp</sub>

LED, active switching output, relay contact  
LED, active switching output

1.7 kg / 90 x 130 x 125 mm  
Alignable: 5 mm horizontally, 15 mm next to active components, 50 mm vertically  
Screw connection  
0.2 - 6 mm<sup>2</sup> / 0.2 - 4 mm<sup>2</sup> / 18 - 10  
0.2 - 6 mm<sup>2</sup> / 0.2 - 4 mm<sup>2</sup> / 12 - 10  
0.2 - 6 mm<sup>2</sup> / 0.2 - 4 mm<sup>2</sup> / 18 - 10  
IP20 / I  
> 630000 h  
> 25 °C ... 70 °C (> 60 °C derating, startup at -40 °C type-tested)

2 kV AC (routine test) / 4 kV AC (type test)  
Conformance with EMC Directive 2004/108/EC  
IEC 60950-1/VDE 0805 (SELV)  
EN 50178/VDE 0160 (PELV)  
DIN VDE 0100-410, DIN VDE 0106-1010  
IEC 60601  
UL Listed UL 508, UL/C-UL Recognized UL 60950,  
UL ANSI/ISA-12.12.01 Class I, Division 2, Groups A, B, C, D  
(Hazardous Location)  
EN 61000-3-2

Ordering data

Type	Order No.	Pcs. / Pkt.
QUINT-PS/ 1AC/48DC/10	2866682	1

Technical data

100 V AC ... 240 V AC  
85 V AC ... 264 V AC / 90 V DC ... 300 V DC  
45 Hz ... 65 Hz / 0 Hz  
8.7 A (120 V AC) / 4.5 A (230 V AC)  
< 15 A / < 1.6 A<sup>2</sup>s  
> 22 ms (120 V AC) / > 25 ms (230 V AC)

48 V DC ±1%  
30 V DC ... 56 V DC (> 48 V constant capacity)

20 A / 22.5 A / 100 A  
B2, B4, B6, B10, C2, C4, C6  
Yes / Yes  
12 W / 74 W  
> 93 % (for 230 V AC and nominal values)  
< 50 mV<sub>pp</sub>

LED, active switching output, relay contact  
LED, active switching output

3.3 kg / 180 x 130 x 125 mm  
Alignable: 5 mm horizontally, 15 mm next to active components, 50 mm vertically  
Screw connection  
0.2 - 6 mm<sup>2</sup> / 0.2 - 4 mm<sup>2</sup> / 14 - 10  
0.5 - 16 mm<sup>2</sup> / 0.5 - 16 mm<sup>2</sup> / 8 - 6  
0.2 - 6 mm<sup>2</sup> / 0.2 - 4 mm<sup>2</sup> / 24 - 10  
IP20 / I  
> 523000 h  
> 25 °C ... 70 °C (> 60 °C derating, startup at -40 °C type-tested)

2 kV AC (routine test) / 4 kV AC (type test)  
Conformance with EMC Directive 2004/108/EC  
IEC 60950-1/VDE 0805 (SELV)  
EN 50178/VDE 0160 (PELV)  
DIN VDE 0100-410, DIN VDE 0106-1010  
-  
UL Listed UL 508, UL/C-UL Recognized UL 60950,  
UL ANSI/ISA-12.12.01 Class I, Division 2, Groups A, B, C, D  
(Hazardous Location)  
EN 61000-3-2

Ordering data

Type	Order No.	Pcs. / Pkt.
QUINT-PS/ 1AC/48DC/20	2866695	1

# Power supply units and UPS

## Power supply units

### QUINT POWER power supply units – for maximum system availability

#### QUINT POWER, 3 AC, 48 V DC

- Quick tripping of standard circuit breakers thanks to the dynamic power reserve SFB (selective fuse breaking) technology with up to 6x the nominal current for 12 ms
- Reliable starting of heavy loads with the static POWER BOOST power reserve with permanently up to 1.5 times the nominal current
- Preventive function monitoring warns against critical operating states before errors occur
- Adjustable output voltage of 30 to 56 V DC



Power supply,  
3 AC, 48 V DC, 20 A

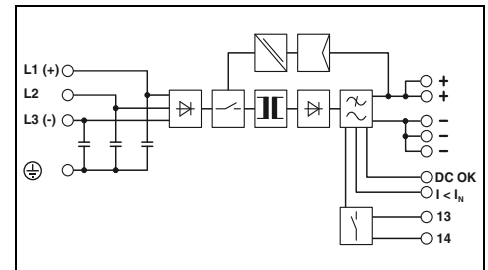

#### Technical data

<b>Input data</b>	Nominal input voltage range Input voltage range AC/DC Frequency range Current consumption (nominal load) Inrush current limitation at 25°C (typ.) / I <sup>2</sup> t Mains buffering (I <sub>n</sub> , typ.)	3x 400 V AC ... 500 V AC 320 V AC ... 575 V AC / 450 V DC ... 800 V DC 45 Hz ... 65 Hz / 0 Hz 3x 2.1 A (400 V AC) / 3x 1.7 A (500 V AC) < 20 A / < 1 A <sup>2</sup> s > 25 ms (400 V AC) / > 35 ms (500 V AC)
<b>Output data</b>	Nominal output voltage Setting range of the output voltage  Output current / POWER BOOST / SFB (12 ms) Magnetic fuse tripping Can be connected in parallel / series Max. power dissipation (no load / nominal load) Efficiency (typ.) Residual ripple	48 V DC ±1% 30 V DC ... 56 V DC (> 48 V constant capacity)  20 A / 22.5 A / 100 A B2, B4, B4, B10, C2, C4, C6 Yes / Yes 24 W / 70 W > 93 % (at 400 V AC and nominal values) < 50 mV <sub>pp</sub>
<b>Signaling</b>	Signaling DC OK Boost signaling	LED, active switching output, relay contact LED, active switching output
<b>General data</b>	Weight / Dimensions W x H x D Spacing when mounting  Connection method Input connection data (solid/stranded/AWG) Output connection data (solid/stranded/AWG) Signal connection data (solid/stranded/AWG) Degree of protection / Protection class MTBF (EN 29500, 40°C) Ambient temperature (operation)	2.5 kg / 96 x 130 x 176 mm Alignable: 5 mm horizontally, 15 mm next to active components, 50 mm vertically Screw connection 0.2 - 6 mm <sup>2</sup> / 0.2 - 4 mm <sup>2</sup> / 18 - 10 0.5 - 16 mm <sup>2</sup> / 0.5 - 16 mm <sup>2</sup> / 8 - 6 0.2 - 6 mm <sup>2</sup> / 0.2 - 4 mm <sup>2</sup> / 18 - 10 IP20 / I > 509000 h -25 °C ... 70 °C (> 60°C derating, startup at -40°C type-tested)
<b>Standards/regulations</b>	Insulation voltage input/output Electromagnetic compatibility Electrical safety Electronic equipm. for electrical power installations Safe isolation UL approvals	2 kV AC (routine test) / 4 kV AC (type test) Conformance with EMC Directive 2004/108/EC IEC 60950-1/VDE 0805 (SELV) EN 50178/VDE 0160 (PELV) DIN VDE 0100-410, DIN VDE 0106-1010 UL Listed UL 508, UL/C-UL Recognized UL 60950, UL ANSI/ISA-12.12.01 Class I, Division 2, Groups A, B, C, D (Hazardous Location) EN 61000-3-2
<b>Limitation of harmonic line currents</b>		
<b>Description</b>	<b>Power supply unit, primary-switched</b>	

#### Ordering data

Type	Order No.	Pcs. / Pkt.
QUINT-PS/ 3AC/48DC/20	2320827	1



## Power supply units

### TRIO POWER power supply units – basic functionality at the highest level

#### TRIO POWER, 1 AC, 24 V DC

- Rugged design with metal housing and wide temperature range of -25 to +70°C
- Third negative terminal block for grounding on the secondary side
- Maximum availability thanks to high MTBF (Mean Time Between Failures) of more than 500,000 hours and high dielectric strength of up to 300 V AC
- Compensation of voltage drops by means of output voltage of 22.5 to 29.5 V DC that can be adjusted on the front



Power supply,  
1 AC, 24 V DC, 2.5 A

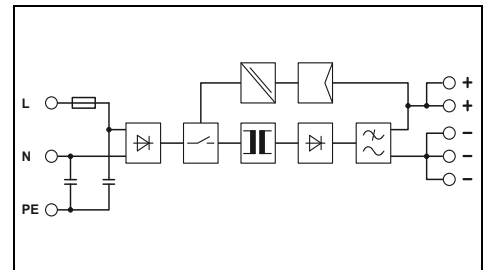

#### Technical data

<b>Input data</b>	
Nominal input voltage range	100 V AC ... 240 V AC
Input voltage range AC	85 V AC ... 264 V AC
Frequency range	45 Hz ... 65 Hz
Current consumption (nominal load)	0.95 A (120 V AC) / 0.5 A (230 V AC)
Inrush current limitation at 25°C (typ.) / I <sup>2</sup> t	< 15 A / 0.5 A <sup>2</sup> s
Mains buffering (I <sub>N</sub> , typ.)	> 20 ms (120 V AC) / > 100 ms (230 V AC)
<b>Output data</b>	
Nominal output voltage	24 V DC ±1%
Setting range of the output voltage	22.5 V DC ... 29.5 V DC (> 24 V constant capacity)
<b>Output current</b>	
Output current	2.5 A
Can be connected in parallel / series	Yes / Yes
Max. power dissipation (no load / nominal load)	0.8 W / 10 W
Efficiency (typ.)	> 86 % (for 230 V AC and nominal values)
Residual ripple	< 30 mV <sub>pp</sub>
<b>Signaling</b>	
Signaling DC OK	LED
<b>General data</b>	
Weight / Dimensions W x H x D	0.5 kg / 32 x 130 x 115 mm
Spacing when mounting	Can be aligned: Horizontally 0 mm, vertically 50 mm
Connection method	Screw connection
Input connection data (solid/stranded/AWG)	0.2 - 2.5 mm <sup>2</sup> / 0.2 - 2.5 mm <sup>2</sup> / 24 - 14
Output connection data (solid/stranded/AWG)	0.2 - 2.5 mm <sup>2</sup> / 0.2 - 2.5 mm <sup>2</sup> / 24 - 14
Degree of protection / Protection class	IP20 / I, with PE connection
MTBF (EN 29500, 40°C)	> 2054000 h
Ambient temperature (operation)	-25 °C ... 70 °C (> 55° C derating)
<b>Standards/regulations</b>	
Insulation voltage input/output	2 kV AC (routine test) / 4 kV AC (type test)
Electromagnetic compatibility	Conformance with EMC Directive 2004/108/EC
Electrical safety	EN 60950-1/VDE 0805 (SELV)
Electronic equipm. for electrical power installations	EN 50178/VDE 0160 (PELV)
Safe isolation	DIN VDE 0100-410, DIN VDE 0106-1010
UL approvals	UL/C-UL listed UL 508, UL/C-UL Recognized UL 60950
Limitation of harmonic line currents	EN 61000-3-2

#### Ordering data

Description	Type	Order No.	Pcs. / Pkt.
Power supply unit, primary-switched	TRIO-PS/ 1AC/24DC/ 2.5	2866268	1



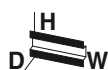

Power supply,  
1 AC, 24 V DC, 5 A



Power supply,  
1 AC, 24 V DC, 10 A



Power supply,  
1 AC, 24 V DC, 20 A

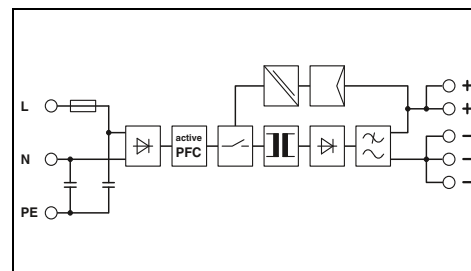
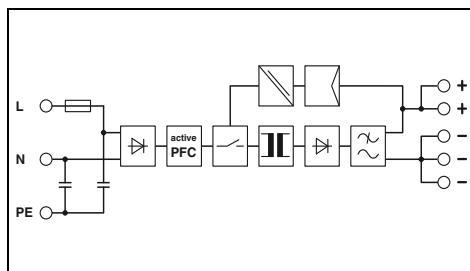
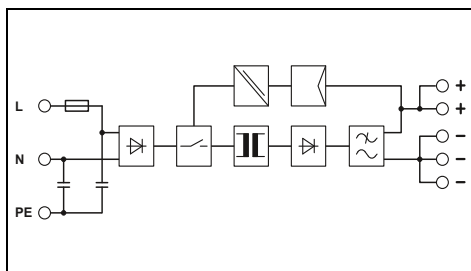

Technical data

100 V AC ... 240 V AC  
85 V AC ... 264 V AC  
45 Hz ... 65 Hz  
1.65 A (120 V AC) / 0.9 A (230 V AC)  
< 15 A / 1.1 A<sup>2</sup>s  
> 20 ms (120 V AC) / > 110 ms (230 V AC)

24 V DC ±1%  
22.5 V DC ... 29.5 V DC (> 24 V constant capacity)

5 A  
Yes / Yes  
1.1 W / 18 W  
> 89 % (for 230 V AC and nominal values)  
< 20 mV<sub>pp</sub>

LED

0.6 kg / 40 x 130 x 115 mm  
Can be aligned: Horizontally 0 mm, vertically 50 mm  
Screw connection  
0.2 - 2.5 mm<sup>2</sup> / 0.2 - 2.5 mm<sup>2</sup> / 24 - 14  
0.2 - 2.5 mm<sup>2</sup> / 0.2 - 2.5 mm<sup>2</sup> / 24 - 14  
IP20 / I, with PE connection  
> 2031000 h  
-25 °C ... 70 °C (> 55° C derating)

2 kV AC (routine test) / 4 kV AC (type test)  
Conformance with EMC Directive 2004/108/EC  
EN 60950-1/VDE 0805 (SELV)  
EN 50178/VDE 0160 (PELV)  
DIN VDE 0100-410, DIN VDE 0106-1010  
UL/C-UL listed UL 508, UL/C-UL Recognized UL 60950

EN 61000-3-2

Technical data

100 V AC ... 240 V AC  
85 V AC ... 264 V AC  
45 Hz ... 65 Hz  
3 A (100 V AC) / 1.5 A (240 V AC)  
< 15 A / 0.7 A<sup>2</sup>s  
> 24 ms (120 V AC) / > 24 ms (230 V AC)

24 V DC ±1%  
22.5 V DC ... 29.5 V DC (> 24 V constant capacity)

10 A  
Yes / Yes  
6.7 W / 30 W  
> 89 % (for 230 V AC and nominal values)  
< 10 mV<sub>pp</sub>

LED

1.4 kg / 60 x 130 x 152.5 mm  
Can be aligned: Horizontally 0 mm, vertically 50 mm  
Screw connection  
0.2 - 2.5 mm<sup>2</sup> / 0.2 - 2.5 mm<sup>2</sup> / 24 - 14  
0.2 - 2.5 mm<sup>2</sup> / 0.2 - 2.5 mm<sup>2</sup> / 24 - 14  
IP20 / I, with PE connection  
> 981000 h  
-25 °C ... 70 °C (> 55° C derating)

2 kV AC (routine test) / 4 kV AC (type test)  
Conformance with EMC Directive 2004/108/EC  
EN 60950-1/VDE 0805 (SELV)  
EN 50178/VDE 0160 (PELV)  
DIN VDE 0100-410, DIN VDE 0106-1010  
UL/C-UL listed UL 508, UL/C-UL Recognized UL 60950

EN 61000-3-2

Technical data

100 V AC ... 240 V AC  
85 V AC ... 264 V AC  
45 Hz ... 65 Hz  
4.6 A (120 V AC) / 2.4 A (230 V AC)  
< 15 A / 1.4 A<sup>2</sup>s  
> 13 ms (120 V AC) / > 13 ms (230 V AC)

24 V DC ±1%  
22.5 V DC ... 29.5 V DC (> 24 V constant capacity)

20 A  
Yes / Yes  
4 W / 46 W  
> 91 % (for 230 V AC and nominal values)  
< 10 mV<sub>pp</sub>

LED

2.2 kg / 115 x 130 x 152.5 mm  
Can be aligned: Horizontally 0 mm, vertically 50 mm  
Screw connection  
0.2 - 2.5 mm<sup>2</sup> / 0.2 - 2.5 mm<sup>2</sup> / 24 - 14  
0.5 - 6 mm<sup>2</sup> / 0.5 - 4 mm<sup>2</sup> / 20 - 10  
IP20 / I, with PE connection  
> 915000 h  
-25 °C ... 70 °C (> 55° C derating)

2 kV AC (routine test) / 4 kV AC (type test)  
Conformance with EMC Directive 2004/108/EC  
EN 60950-1/VDE 0805 (SELV)  
EN 50178/VDE 0160 (PELV)  
DIN VDE 0100-410, DIN VDE 0106-1010  
UL/C-UL listed UL 508, UL/C-UL Recognized UL 60950

EN 61000-3-2

Ordering data

Type	Order No.	Pcs. / Pkt.
TRIO-PS/ 1AC/24DC/5	2866310	1

Ordering data

Type	Order No.	Pcs. / Pkt.
TRIO-PS/ 1AC/24DC/10	2866323	1

Ordering data

Type	Order No.	Pcs. / Pkt.
TRIO-PS/ 1AC/24DC/20	2866381	1

# Power supply units and UPS

## Power supply units

### TRIO POWER power supply units – basic functionality at the highest level

#### TRIO POWER, 3 AC, 24 V DC

- Rugged design with metal housing and wide temperature range of -25 to +70°C
- Third negative terminal block for grounding on the secondary side
- Maximum availability thanks to high MTBF (Mean Time Between Failures) of more than 500,000 hours
- Compensation of voltage drops by means of output voltage of 22.5 to 29.5 V DC that can be adjusted on the front



Power supply,  
3 AC, 24 V DC, 5 A

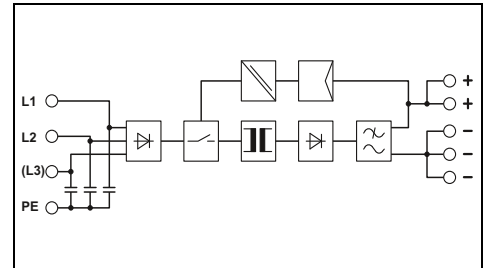

#### Technical data

##### Input data

Nominal input voltage range  
Input voltage range AC  
Frequency range  
Current consumption (nominal load)  
Inrush current limitation at 25°C (typ.) / I<sup>2</sup>t  
Mains buffering (I<sub>N</sub>, typ.)

2x / 3x 400 V AC ... 500 V AC  
320 V AC ... 575 V AC  
45 Hz ... 65 Hz  
3x 0.3 A (400 V AC) / 3x 0.25 A (500 V AC)  
< 15 A / 0.2 A<sup>2</sup>s  
> 20 ms (400 V AC) / > 30 ms (480 V AC)

##### Output data

Nominal output voltage  
Setting range of the output voltage

24 V DC ±1%  
22.5 V DC ... 29.5 V DC (> 24 V constant capacity)

##### Output current

Can be connected in parallel / series  
Max. power dissipation (no load / nominal load)  
Efficiency (typ.)  
Residual ripple

5 A  
Yes / Yes  
4 W / 15 W  
> 89 % (at 400 V AC and nominal values)  
< 30 mV<sub>pp</sub>

##### Signaling

Signaling DC OK

LED

##### General data

Weight / Dimensions W x H x D  
Spacing when mounting  
Connection method  
Input connection data (solid/stranded/AWG)  
Output connection data (solid/stranded/AWG)  
Degree of protection / Protection class  
MTBF (EN 29500, 40°C)  
Ambient temperature (operation)  
Standards/regulations  
Insulation voltage input/output  
Electromagnetic compatibility  
Electrical safety  
Electronic equipm. for electrical power installations  
Safe isolation  
UL approvals

0.6 kg / 40 x 130 x 115 mm  
Can be aligned: Horizontally 0 mm, vertically 50 mm  
Screw connection  
0.2 - 2.5 mm<sup>2</sup> / 0.2 - 2.5 mm<sup>2</sup> / 24 - 14  
0.2 - 2.5 mm<sup>2</sup> / 0.2 - 2.5 mm<sup>2</sup> / 16 - 12  
IP20 / I, with PE connection  
> 1474000 h  
-25 °C ... 70 °C (> 55° C derating)  
2 kV AC (routine test) / 4 kV AC (type test)  
Conformance with EMC Directive 2004/108/EC  
EN 60950-1/VDE 0805 (SELV)  
EN 50178/VDE 0160 (PELV)  
DIN VDE 0100-410, DIN VDE 0106-1010  
UL/C-UL listed UL 508, UL/C-UL Recognized UL 60950

##### Limitation of harmonic line currents

EN 61000-3-2

##### Description

Power supply unit, primary-switched

#### Ordering data

Type	Order No.	Pcs. / Pkt.
TRIO-PS/ 3AC/24DC/ 5	2866462	1



Power supply,  
3 AC, 24 V DC, 10 A



Power supply,  
3 AC, 24 V DC, 20 A



Power supply unit,  
3 AC, 24 V DC, 40 A

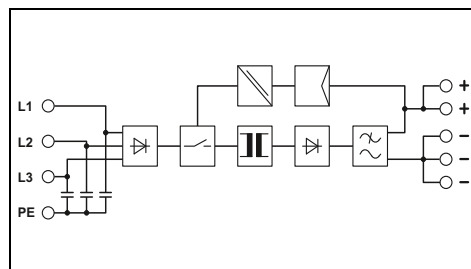
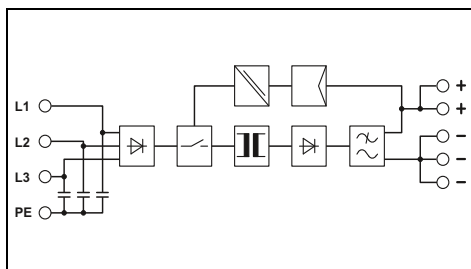
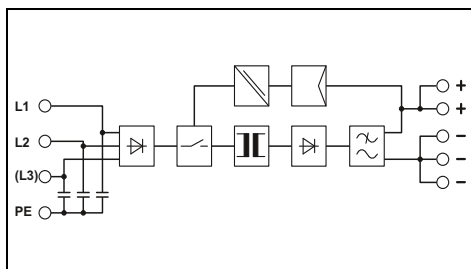

Technical data

2x / 3x 400 V AC ... 500 V AC  
320 V AC ... 575 V AC  
45 Hz ... 65 Hz  
3x 0.6 A (400 V AC) / 3x 0.5 A (480 V AC)  
< 15 A / 0.2 A<sup>2</sup>s  
> 20 ms (400 V AC) / > 25 ms (480 V AC)

24 V DC ±1%  
22.5 V DC ... 29.5 V DC (> 24 V constant capacity)

10 A  
Yes / Yes  
6 W / 28 W  
> 89 % (at 400 V AC and nominal values)  
< 10 mV<sub>pp</sub>

LED

1.3 kg / 60 x 130 x 152.5 mm  
Can be aligned: Horizontally 0 mm, vertically 50 mm  
Screw connection  
0.2 - 2.5 mm<sup>2</sup> / 0.2 - 2.5 mm<sup>2</sup> / 24 - 14  
0.2 - 2.5 mm<sup>2</sup> / 0.2 - 2.5 mm<sup>2</sup> / 16 - 12  
IP20 / I, with PE connection  
> 1156000 h  
-25 °C ... 70 °C (> 55° C derating)

2 kV AC (routine test) / 4 kV AC (type test)  
Conformance with EMC Directive 2004/108/EC  
EN 60950-1/VDE 0805 (SELV)  
EN 50178/VDE 0160 (PELV)  
DIN VDE 0100-410, DIN VDE 0106-1010  
UL/C-UL listed UL 508, UL/C-UL Recognized UL 60950

EN 61000-3-2

Technical data

3x 400 V AC ... 500 V AC  
320 V AC ... 575 V AC  
45 Hz ... 65 Hz  
3x 1.1 A (400 V AC) / 3x 0.8 A (480 V AC)  
< 15 A / 0.5 A<sup>2</sup>s  
> 17 ms (400 V AC) / > 20 ms (480 V AC)

24 V DC ±1%  
22.5 V DC ... 29.5 V DC (> 24 V constant capacity)

20 A  
Yes / Yes  
< 6 W / < 48 W  
> 91 % (at 400 V AC and nominal values)  
< 10 mV<sub>pp</sub>

LED

2 kg / 115 x 130 x 152.5 mm  
Can be aligned: Horizontally 0 mm, vertically 50 mm  
Screw connection  
0.2 - 2.5 mm<sup>2</sup> / 0.2 - 2.5 mm<sup>2</sup> / 24 - 14  
0.5 - 6 mm<sup>2</sup> / 0.5 - 4 mm<sup>2</sup> / 12 - 10  
IP20 / I, with PE connection  
> 1190000 h  
-25 °C ... 70 °C (> 55° C derating)

2 kV AC (routine test) / 4 kV AC (type test)  
Conformance with EMC Directive 2004/108/EC  
EN 60950-1/VDE 0805 (SELV)  
EN 50178/VDE 0160 (PELV)  
DIN VDE 0100-410, DIN VDE 0106-1010  
UL/C-UL listed UL 508, UL/C-UL Recognized UL 60950

EN 61000-3-2

Technical data

3x 400 V AC ... 500 V AC  
320 V AC ... 575 V AC  
45 Hz ... 65 Hz  
3x 2 A (400 V AC) / 3x 1.6 A (480 V AC)  
< 20 A / 1.3 A<sup>2</sup>s  
> 16 ms (400 V AC) / > 20 ms (480 V AC)

24 V DC ±1%  
22.5 V DC ... 29.5 V DC (> 24 V constant capacity)

40 A  
Yes / Yes  
16 W / 91 W  
> 91.5 % (at 400 V AC and nominal values)  
< 20 mV<sub>pp</sub>

LED

2.9 kg / 139 x 130 x 190 mm  
Can be aligned: Horizontally 0 mm, vertically 50 mm  
Screw connection  
0.2 - 6 mm<sup>2</sup> / 0.2 - 4 mm<sup>2</sup> / 22 - 10  
0.5 - 16 mm<sup>2</sup> / 0.5 - 10 mm<sup>2</sup> / 8 - 6  
IP20 / I, with PE connection  
> 930000 h  
-25 °C ... 70 °C (> 55° C derating)

2 kV AC (routine test) / 4 kV AC (type test)  
Conformance with EMC Directive 2004/108/EC  
EN 60950-1/VDE 0805 (SELV)  
EN 50178/VDE 0160 (PELV)  
DIN VDE 0100-410, DIN VDE 0106-1010  
UL/C-UL listed UL 508, UL/C-UL Recognized UL 60950

EN 61000-3-2

Ordering data

Type	Order No.	Pcs. / Pkt.
TRIO-PS/ 3AC/24DC/10	2866459	1

Ordering data

Type	Order No.	Pcs. / Pkt.
TRIO-PS/ 3AC/24DC/20	2866394	1

Ordering data

Type	Order No.	Pcs. / Pkt.
TRIO-PS/ 3AC/24DC/40	2866404	1

# Power supply units and UPS

## Power supply units

### TRIO POWER power supply units – basic functionality at the highest level

#### TRIO POWER, 600 V DC, 24 V DC

– Connection to 600 V DC intermediate circuits of frequency inverters: in the event of a line supply failure, 24 V loads are supplied using the kinetic energy of the motor. In this way, the motor acts as a generator and supplies energy to the intermediate circuits (e.g., in plastic injection molding machines).



Power supply,  
600 V DC, 24 V DC, 20 A



Power supply,  
1 AC, 12 V DC, 5 A

#### TRIO POWER, 1 AC, 12 V DC and 48 V DC

– Adjustable output voltage of 10 to 18 V DC, or 30 to 56 V DC

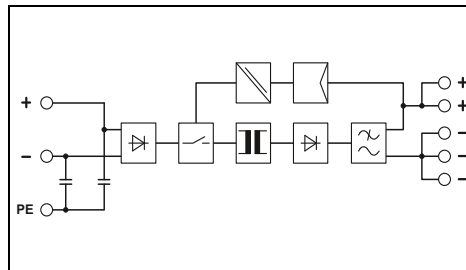

#### Technical data

Input data
Nominal input voltage range
Input voltage range AC/DC
Frequency range
Current consumption (nominal load)
Inrush current limitation at 25°C (typ.) / I <sup>2</sup> t
Mains buffering (I <sub>N</sub> , typ.)
Output data
Nominal output voltage
Setting range of the output voltage
Output current
Can be connected in parallel / series
Max. power dissipation (no load / nominal load)
Efficiency (typ.)
Residual ripple
Signaling
Signaling DC OK
General data
Weight / Dimensions W x H x D
Spacing when mounting
Connection method
Input connection data (solid/stranded/AWG)
Output connection data (solid/stranded/AWG)
Degree of protection / Protection class
MTBF (EN 29500, 40°C)
Ambient temperature (operation)
Standards/regulations
Insulation voltage input/output
Electromagnetic compatibility
Electrical safety
Electronic equipm. for electrical power installations
Safe isolation
UL approvals
Limitation of harmonic line currents

600 V DC
- / 450 V DC ... 840 V DC
- / 0 Hz
0.9 A (600 V DC)
< 26 A / 0.8 A <sup>2</sup> s
> 15 ms (600 V DC)
24 V DC ±1%
22.5 V DC ... 29.5 V DC (U <sub>IN</sub> > 475 V DC)
22.5 V DC ... 28 V DC (U <sub>IN</sub> ≤ 475 V DC)
20 A
Yes / Yes
3.8 W / 45 W
> 91 % (With 600 V DC and nominal values)
< 40 mV <sub>pp</sub>
LED
2 kg / 115 x 130 x 152.5 mm
Can be aligned: Horizontally 0 mm, vertically 50 mm
Screw connection
0.2 - 2.5 mm <sup>2</sup> / 0.2 - 2.5 mm <sup>2</sup> / 24 - 14
0.5 - 6 mm <sup>2</sup> / 0.5 - 4 mm <sup>2</sup> / 12 - 10
IP20 / I, with PE connection
> 701147 h
-25 °C ... 70 °C (> 55 °C derating)
2 kV AC (routine test) / 4 kV AC (type test)
Conformance with EMC Directive 2004/108/EC
EN 60950-1/VDE 0805 (SELV)
EN 50178/VDE 0160 (PELV)
DIN VDE 0100-410 , DIN VDE 0106-1010
UL/C-UL listed UL 508 , UL/C-UL Recognized UL 60950
EN 61000-3-2

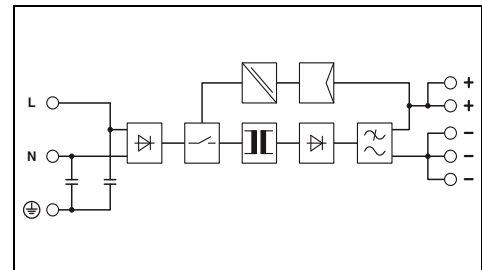

#### Technical data

100 V AC ... 240 V AC
85 V AC ... 264 V AC
45 Hz ... 65 Hz
1.1 A (100 V AC) / 0.5 A (240 V AC)
< 15 A / < 0.5 A <sup>2</sup> s
> 26 ms (120 V AC) / > 100 ms (230 V AC)
12 V DC ±1%
10 V DC ... 18 V DC (> 12 V constant capacity)
5 A
Yes / Yes
0.9 W / 11 W
> 83 % (for 230 V AC and nominal values)
< 20 mV <sub>pp</sub>
LED
0.5 kg / 32 x 130 x 115 mm
Can be aligned: Horizontally 0 mm, vertically 50 mm
Screw connection
0.2 - 2.5 mm <sup>2</sup> / 0.2 - 2.5 mm <sup>2</sup> / 24 - 14
0.2 - 2.5 mm <sup>2</sup> / 0.2 - 2.5 mm <sup>2</sup> / 24 - 14
IP20 / I, with PE connection
> 1853000 h
-25 °C ... 70 °C (> 55 °C derating)
2 kV AC (routine test) / 4 kV AC (type test)
Conformance with EMC Directive 2004/108/EC
EN 60950-1/VDE 0805 (SELV)
EN 50178/VDE 0160 (PELV)
DIN VDE 0100-410 , DIN VDE 0106-1010
UL/C-UL listed UL 508 , UL/C-UL Recognized UL 60950
EN 61000-3-2

#### Ordering data

Description	Type	Order No.	Pcs. / Pkt.
Power supply unit, primary-switched	TRIO-PS/600DC/24DC/20	2866530	1

#### Ordering data

Description	Type	Order No.	Pcs. / Pkt.
Power supply unit, primary-switched	TRIO-PS/ 1AC/12DC/ 5	2866475	1



Power supply,  
1 AC, 12 V DC, 10 A

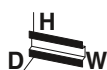

Power supply,  
1 AC, 48 V DC, 5 A



Power supply,  
1 AC, 48 V DC, 10 A

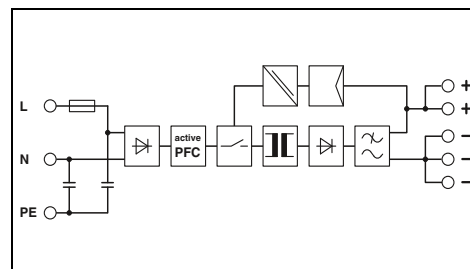
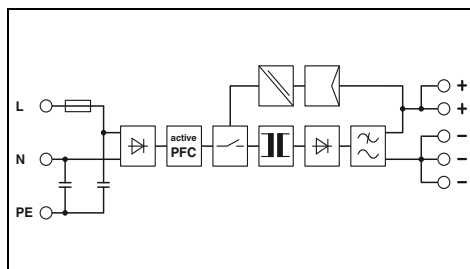
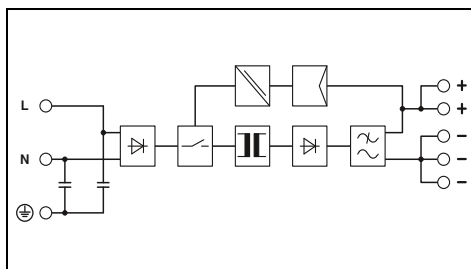

Technical data

100 V AC ... 240 V AC  
85 V AC ... 264 V AC  
45 Hz ... 65 Hz  
1.7 A (120 V AC) / 0.9 A (230 V AC)  
< 15 A / < 1.1 A<sup>2</sup>s  
> 20 ms (120 V AC) / > 86 ms (230 V AC)

12 V DC ±1%  
10 V DC ... 18 V DC (> 12 V constant capacity)

10 A  
Yes / Yes  
1.1 W / 18 W  
> 86 % (for 230 V AC and nominal values)  
< 20 mV<sub>PP</sub>

LED

0.6 kg / 40 x 130 x 115 mm  
Can be aligned: Horizontally 0 mm, vertically 50 mm  
Screw connection  
0.2 - 2.5 mm<sup>2</sup> / 0.2 - 2.5 mm<sup>2</sup> / 24 - 14  
0.2 - 2.5 mm<sup>2</sup> / 0.2 - 2.5 mm<sup>2</sup> / 24 - 14  
IP20 / I, with PE connection  
> 1871000 h  
-25 °C ... 70 °C (> 55° C derating)

2 kV AC (routine test) / 4 kV AC (type test)  
Conformance with EMC Directive 2004/108/EC  
EN 60950-1/VDE 0805 (SELV)  
EN 50178/VDE 0160 (PELV)  
DIN VDE 0100-410, DIN VDE 0106-1010  
UL/C-UL listed UL 508, UL/C-UL Recognized UL 60950

EN 61000-3-2

Technical data

100 V AC ... 240 V AC  
85 V AC ... 264 V AC  
45 Hz ... 65 Hz  
2.5 A (120 V AC) / 1.3 A (230 V AC)  
< 15 A / < 0.7 A<sup>2</sup>s  
> 15 ms (120 V AC) / > 16 ms (230 V AC)

48 V DC ±1%  
30 V DC ... 56 V DC (> 48 V constant capacity)

5 A  
Yes / Yes  
7 W / 28 W  
> 89 % (for 230 V AC and nominal values)  
< 50 mV<sub>PP</sub>

LED

1.4 kg / 60 x 130 x 152.5 mm  
Can be aligned: Horizontally 0 mm, vertically 50 mm  
Screw connection  
0.2 - 2.5 mm<sup>2</sup> / 0.2 - 2.5 mm<sup>2</sup> / 24 - 14  
0.2 - 2.5 mm<sup>2</sup> / 0.2 - 2.5 mm<sup>2</sup> / 24 - 14  
IP20 / I, with PE connection  
> 1337000 h  
-25 °C ... 70 °C (> 55° C derating)

2 kV AC (routine test) / 4 kV AC (type test)  
Conformance with EMC Directive 2004/108/EC  
EN 60950-1/VDE 0805 (SELV)  
EN 50178/VDE 0160 (PELV)  
DIN VDE 0100-410, DIN VDE 0106-1010  
UL/C-UL listed UL 508, UL/C-UL Recognized UL 60950

EN 61000-3-2

Technical data

100 V AC ... 240 V AC  
85 V AC ... 264 V AC  
45 Hz ... 65 Hz  
4.6 A (120 V AC) / 2.4 A (230 V AC)  
< 15 A / < 1.4 A<sup>2</sup>s  
> 13 ms (120 V AC) / > 18 ms (230 V AC)

48 V DC ±1%  
30 V DC ... 56 V DC (> 48 V constant capacity)

10 A  
Yes / Yes  
8 W / 49 W  
> 91 % (for 230 V AC and nominal values)  
< 50 mV<sub>PP</sub>

LED

1.9 kg / 115 x 130 x 152.5 mm  
Can be aligned: Horizontally 0 mm, vertically 50 mm  
Screw connection  
0.2 - 2.5 mm<sup>2</sup> / 0.2 - 2.5 mm<sup>2</sup> / 24 - 14  
0.5 - 6 mm<sup>2</sup> / 0.5 - 4 mm<sup>2</sup> / 20 - 10  
IP20 / I, with PE connection  
> 1168000 h  
-25 °C ... 70 °C (> 55° C derating)

2 kV AC (routine test) / 4 kV AC (type test)  
Conformance with EMC Directive 2004/108/EC  
EN 60950-1/VDE 0805 (SELV)  
EN 50178/VDE 0160 (PELV)  
DIN VDE 0100-410, DIN VDE 0106-1010  
UL Listed UL 508, UL/C-UL Recognized UL 60950

EN 61000-3-2

Ordering data

Type	Order No.	Pcs. / Pkt.
TRIO-PS/ 1AC/12DC/10	2866488	1

Ordering data

Type	Order No.	Pcs. / Pkt.
TRIO-PS/ 1AC/48DC/5	2866491	1

Ordering data

Type	Order No.	Pcs. / Pkt.
TRIO-PS/ 1AC/48DC/10	2866501	1

# Power supply units and UPS

## Power supply units

### MINI POWER power supply units - for measurement and control technology

#### MINI POWER, 1 AC, 24 V DC

- Easy-to-maintain connection method thanks to keyed COMBICON connector
- Remote monitoring of output voltage via switching output



Power supply,  
1 AC, 24 V DC, 1.3 A



Power supply unit, 1 AC, 24 V DC, 1.5 A,  
flat design, optional DIN rail connector

#### MINI POWER, 1.5 A

- Flat power supply units with a depth of just 95 mm
  - Optional: DIN rail connector for supplying other modules
- Per power supply:  
2 x ME 17,5 TBUS 1,5/5-ST-3,82 GN  
(Order No.: 2709561)



#### MINI POWER, 100 W

- Output power limited to 100 W: specifically for applications that require certification according to UL 1310/508 Listed Class 2

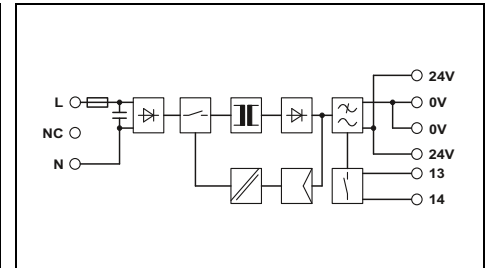
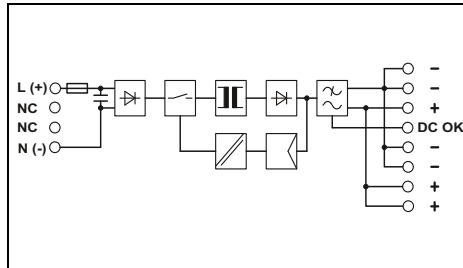

#### Technical data

#### Technical data

Input data	
Nominal input voltage range	100 V AC ... 240 V AC
Input voltage range AC/DC	85 V AC ... 264 V AC / 90 V DC ... 350 V DC
Frequency range	45 Hz ... 65 Hz / 0 Hz
Current consumption (nominal load)	0.65 A (120 V AC) / 0.25 A (230 V AC)
Inrush current limitation at 25°C (typ.) / I <sup>2</sup> t	< 15 A / 0.6 A <sup>2</sup> s
Mains buffering (I <sub>N</sub> , typ.)	> 20 ms (120 V AC) / > 110 ms (230 V AC)
Output data	
Nominal output voltage	24 V DC ±1%
Setting range of the output voltage	22.5 V DC ... 28.5 V DC (> 24 V constant capacity)
Output current / POWER BOOST	1.3 A / 1.6 A
Can be connected in parallel / series	Yes / Yes
Max. power dissipation (no load / nominal load)	0.9 W / 4.5 W
Efficiency (typ.)	> 85 % (for 230 V AC and nominal values)
Residual ripple	< 20 mV <sub>pp</sub>
Signaling	
Signaling DC OK	LED, active switching output
General data	
Weight / Dimensions W x H x D	0.2 kg / 22.5 x 99 x 107 mm
Spacing when mounting	Can be aligned: Horizontally 0 mm, vertically 50 mm
Connection method	Plug-in screw connection
Connection data solid / stranded / AWG	0.2 - 2.5 mm <sup>2</sup> / 0.2 - 2.5 mm <sup>2</sup> / 24 - 12
Degree of protection / Protection class	IP20 / II (in an enclosed control cabinet)
MTBF (EN 29500, 40°C)	> 1104000 h
Ambient temperature (operation)	-25 °C ... 70 °C (> 60 °C derating)
Standards/regulations	
Insulation voltage input/output	3 kV (Routine test) / 4 kV (type test)
Electromagnetic compatibility	Conformance with EMC Directive 2004/108/EC
Electrical safety	EN 60950-1/VDE 0805 (SELV)
Electronic equipm. for electrical power installations	EN 50178/VDE 0160 (PELV)
Safe isolation	DIN VDE 0100-410, DIN VDE 0106-1010
UL approvals	UL/C-UL listed UL 508, UL/C-UL Recognized UL 60950, UL ANSI/ISA-12.12.01 Class I, Division 2, Groups A, B, C, D (Hazardous Location), NEC Class 2 as per UL 1310
Limitation of harmonic line currents	EN 61000-3-2

Input data	
Nominal input voltage range	100 V AC ... 240 V AC
Input voltage range AC/DC	85 V AC ... 264 V AC / 90 V DC ... 350 V DC
Frequency range	45 Hz ... 65 Hz / 0 Hz
Current consumption (nominal load)	0.65 A (120 V AC) / 0.25 A (230 V AC)
Inrush current limitation at 25°C (typ.) / I <sup>2</sup> t	< 15 A / 0.6 A <sup>2</sup> s
Mains buffering (I <sub>N</sub> , typ.)	> 20 ms (120 V AC) / > 110 ms (230 V AC)
Output data	
Nominal output voltage	24 V DC ±1%
Setting range of the output voltage	22.5 V DC ... 28.5 V DC (> 24 V constant capacity)
Output current / POWER BOOST	1.3 A / 1.6 A
Can be connected in parallel / series	Yes / Yes
Max. power dissipation (no load / nominal load)	0.9 W / 4.5 W
Efficiency (typ.)	> 85 % (for 230 V AC and nominal values)
Residual ripple	< 20 mV <sub>pp</sub>
Signaling	
Signaling DC OK	LED, active switching output
General data	
Weight / Dimensions W x H x D	0.2 kg / 22.5 x 99 x 107 mm
Spacing when mounting	Can be aligned: Horizontally 0 mm, vertically 50 mm
Connection method	Plug-in screw connection
Connection data solid / stranded / AWG	0.2 - 2.5 mm <sup>2</sup> / 0.2 - 2.5 mm <sup>2</sup> / 24 - 12
Degree of protection / Protection class	IP20 / II (in an enclosed control cabinet)
MTBF (EN 29500, 40°C)	> 1104000 h
Ambient temperature (operation)	-25 °C ... 70 °C (> 60 °C derating)
Standards/regulations	
Insulation voltage input/output	3 kV (Routine test) / 4 kV (type test)
Electromagnetic compatibility	Conformance with EMC Directive 2004/108/EC
Electrical safety	EN 60950-1/VDE 0805 (SELV)
Electronic equipm. for electrical power installations	EN 50178/VDE 0160 (PELV)
Safe isolation	DIN VDE 0100-410, DIN VDE 0106-1010
UL approvals	UL/C-UL listed UL 508, UL/C-UL Recognized UL 60950, UL ANSI/ISA-12.12.01 Class I, Division 2, Groups A, B, C, D (Hazardous Location), NEC Class 2 as per UL 1310
Limitation of harmonic line currents	EN 61000-3-2

Input data	
Nominal input voltage range	100 V AC ... 240 V AC
Input voltage range AC/DC	85 V AC ... 264 V AC
Frequency range	45 Hz ... 65 Hz
Current consumption (nominal load)	0.75 A (120 V AC) / 0.45 A (230 V AC)
Inrush current limitation at 25°C (typ.) / I <sup>2</sup> t	< 15 A / 0.6 A <sup>2</sup> s
Mains buffering (I <sub>N</sub> , typ.)	> 35 ms (120 V AC) / > 150 ms (230 V AC)
Output data	
Nominal output voltage	24 V DC ±1%
Setting range of the output voltage	-
Output current / POWER BOOST	1.5 A / 2 A
Can be connected in parallel / series	Yes / No
Max. power dissipation (no load / nominal load)	1.5 W / 6.5 W
Efficiency (typ.)	> 84 % (for 230 V AC and nominal values)
Residual ripple	< 40 mV <sub>pp</sub>
Signaling	
Signaling DC OK	LED, relay contact
General data	
Weight / Dimensions W x H x D	0.25 kg / 35 x 99 x 95 mm
Spacing when mounting	Can be aligned: Horizontally 0 mm, vertically 50 mm
Connection method	Plug-in screw connection
Connection data solid / stranded / AWG	0.2 - 2.5 mm <sup>2</sup> / 0.2 - 2.5 mm <sup>2</sup> / 24 - 12
Degree of protection / Protection class	IP20 / II (in an enclosed control cabinet)
MTBF (EN 29500, 40°C)	> 2789000 h
Ambient temperature (operation)	-25 °C ... 70 °C (> 60 °C derating)
Standards/regulations	
Insulation voltage input/output	3 kV (Routine test) / 4 kV (type test)
Electromagnetic compatibility	Conformance with EMC Directive 2004/108/EC
Electrical safety	EN 60950-1/VDE 0805 (SELV)
Electronic equipm. for electrical power installations	EN 50178/VDE 0160 (PELV)
Safe isolation	DIN VDE 0100-410, DIN VDE 0106-1010
UL approvals	UL/C-UL listed UL 508, UL/C-UL Recognized UL 60950, UL ANSI/ISA-12.12.01 Class I, Division 2, Groups A, B, C, D (Hazardous Location)
Limitation of harmonic line currents	EN 61000-3-2

#### Ordering data

#### Ordering data

Description	Type	Order No.	Pcs. / Pkt.
Power supply unit, primary-switched	MINI-PS-100-240AC/24DC/1.3	2866446	1

Description	Type	Order No.	Pcs. / Pkt.
Power supply unit, primary-switched	MINI-SYS-PS-100-240AC/24DC/1.5	2866983	1

#### Accessories

#### Accessories

DIN rail connector (optional), for routing through the supply voltage and data signal, two pieces are required per device

Description	Type	Order No.	Pcs. / Pkt.
DIN rail connector (optional), for routing through the supply voltage and data signal, two pieces are required per device	ME 17,5 TBUS 1,5/5-ST-3,81 GN	2709561	10

Description	Type	Order No.	Pcs. / Pkt.
DIN rail connector (optional), for routing through the supply voltage and data signal, two pieces are required per device	ME 17,5 TBUS 1,5/5-ST-3,81 GN	2709561	10



Power supply,  
1 AC, 24 V DC, 2 A



Power supply,  
1 AC, 24 V DC, 100 W  
NEC Class 2



Power supply,  
1 AC, 24 V DC, 4 A

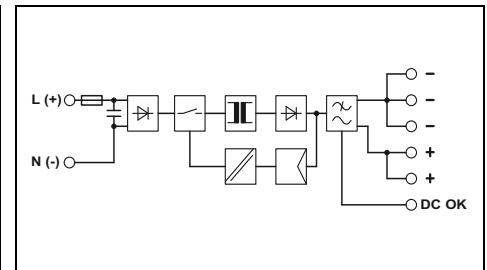
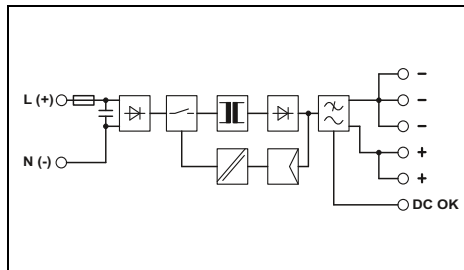
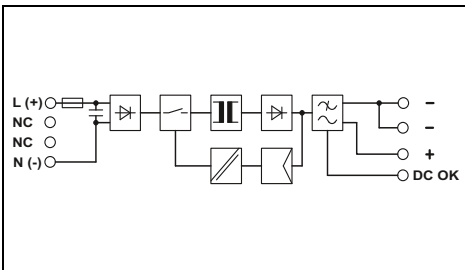

Technical data

100 V AC ... 240 V AC  
85 V AC ... 264 V AC / 90 V DC ... 350 V DC  
45 Hz ... 65 Hz / 0 Hz  
0.7 A (120 V AC) / 0.4 A (230 V AC)  
< 15 A / 4.1 A<sup>2</sup>s  
> 35 ms (120 V AC) / > 170 ms (230 V AC)

24 V DC ±1%  
22.5 V DC ... 28.5 V DC (> 24 V constant capacity)

2 A / 2.9 A  
Yes / Yes  
2 W / 7 W  
> 88 % (for 230 V AC and nominal values)  
< 20 mV<sub>PP</sub>

LED, active switching output

0.25 kg / 45 x 99 x 107 mm  
Can be aligned: Horizontally 0 mm, vertically 50 mm  
Plug-in screw connection  
0.2 - 2.5 mm<sup>2</sup> / 0.2 - 2.5 mm<sup>2</sup> / 24 - 12  
IP20 / II (in an enclosed control cabinet)  
> 507981 h  
-25 °C ... 70 °C (> 60 °C derating)

3 kV (Routine test) / 4 kV (type test)  
Conformance with EMC Directive 2004/108/EC  
EN 60950-1/VDE 0805 (SELV)  
EN 50178/VDE 0160 (PELV)  
DIN VDE 0100-410, DIN VDE 0106-1010  
UL/C-UL listed UL 508, UL/C-UL Recognized UL 60950,  
UL ANSI/ISA-12.12.01 Class I, Division 2, Groups A, B, C, D  
(Hazardous Location), NEC Class 2 as per UL 1310

EN 61000-3-2

Ordering data

Type	Order No.	Pcs. / Pkt.
MINI-PS-100-240AC/24DC/2	2938730	1

Accessories

--	--	--

Technical data

100 V AC ... 240 V AC  
85 V AC ... 264 V AC / 90 V DC ... 350 V DC  
45 Hz ... 65 Hz / 0 Hz  
1.3 A (120 V AC) / 0.8 A (230 V AC)  
< 15 A / 2.1 A<sup>2</sup>s  
> 20 ms (120 V AC) / > 100 ms (230 V AC)

24 V DC ±1%  
22.5 V DC ... 26 V DC (> 24 V constant capacity)

3.8 A  
Yes / Yes  
2.5 W / 12 W  
> 88 % (for 230 V AC and nominal values)  
< 40 mV<sub>PP</sub>

LED, active switching output

0.4 kg / 67.5 x 99 x 107 mm  
Can be aligned: Horizontally 0 mm, vertically 50 mm  
Plug-in screw connection  
0.2 - 2.5 mm<sup>2</sup> / 0.2 - 2.5 mm<sup>2</sup> / 24 - 12  
IP20 / II (in an enclosed control cabinet)  
> 815000 h  
-25 °C ... 70 °C (> 60 °C derating)

3 kV (Routine test) / 3 kV (type test)  
Conformance with EMC Directive 2004/108/EC  
EN 60950-1/VDE 0805 (SELV)  
EN 50178/VDE 0160 (PELV)  
DIN VDE 0100-410, DIN VDE 0106-1010  
UL/C-UL listed UL 508, UL/C-UL Recognized UL 60950,  
UL ANSI/ISA-12.12.01 Class I, Division 2, Groups A, B, C, D  
(Hazardous Location), NEC Class 2 as per UL 1310

EN 61000-3-2

Ordering data

Type	Order No.	Pcs. / Pkt.
MINI-PS-100-240AC/24DC/C2LPS	2866336	1

Accessories

--	--	--

Technical data

100 V AC ... 240 V AC  
85 V AC ... 264 V AC / 90 V DC ... 350 V DC  
45 Hz ... 65 Hz / 0 Hz  
1.3 A (120 V AC) / 0.8 A (230 V AC)  
< 15 A / 2.1 A<sup>2</sup>s  
> 20 ms (120 V AC) / > 100 ms (230 V AC)

24 V DC ±1%  
22.5 V DC ... 28.5 V DC (> 24 V constant capacity)

4 A / 5 A  
Yes / Yes  
2.5 W / 12 W  
> 88 % (for 230 V AC and nominal values)  
< 20 mV<sub>PP</sub>

LED, active switching output

0.4 kg / 67.5 x 99 x 107 mm  
Can be aligned: Horizontally 0 mm, vertically 50 mm  
Plug-in screw connection  
0.2 - 2.5 mm<sup>2</sup> / 0.2 - 2.5 mm<sup>2</sup> / 24 - 12  
IP20 / II (in an enclosed control cabinet)  
> 815000 h  
-25 °C ... 70 °C (> 60 °C derating)

3 kV (Routine test) / 3 kV (type test)  
Conformance with EMC Directive 2004/108/EC  
EN 60950-1/VDE 0805 (SELV)  
EN 50178/VDE 0160 (PELV)  
DIN VDE 0100-410, DIN VDE 0106-1010  
UL/C-UL listed UL 508, UL/C-UL Recognized UL 60950,  
UL ANSI/ISA-12.12.01 Class I, Division 2, Groups A, B, C, D  
(Hazardous Location)

EN 61000-3-2

Ordering data

Type	Order No.	Pcs. / Pkt.
MINI-PS-100-240AC/24DC/4	2938837	1

Accessories

--	--	--

# Power supply units and UPS

## Power supply units

### MINI POWER power supply units - for measurement and control technology

#### MINI POWER, 1 AC, 5 to 15 V DC

- Easy-to-maintain connection method thanks to keyed COMBICON connector
- Remote monitoring of output voltage via switching output

#### MINI POWER, 5 and 10 - 15 V DC

- Adjustable output voltage of 4.5 to 5.5 V DC, or of 10 to 15 V DC

#### MINI POWER, ±15 V DC

- For supplying operational amplifiers



Power supply,  
1 AC, 5 V DC, 3 A



Ex:

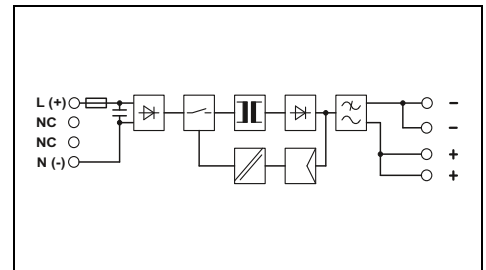

Input data	
Nominal input voltage range	100 V AC ... 240 V AC
Input voltage range AC/DC	85 V AC ... 264 V AC / 90 V DC ... 350 V DC
Frequency range	45 Hz ... 65 Hz / 0 Hz
Current consumption (nominal load)	0.4 A (120 V AC) / 0.2 A (230 V AC)
Inrush current limitation at 25°C (typ.) / I <sup>2</sup> t	< 15 A / 1.5 A <sup>2</sup> s
Mains buffering (I <sub>N</sub> , typ.)	> 30 ms (120 V AC) / > 140 ms (230 V AC)
Output data	
Nominal output voltage	5 V DC ±1%
Setting range of the output voltage	4.5 V DC ... 5.5 V DC (> 5 V constant capacity)
Output current / POWER BOOST	3 A / 5 A
Can be connected in parallel / series	Yes / Yes
Max. power dissipation (no load / nominal load)	1 W / 5 W
Efficiency (typ.)	> 73 % (for 230 V AC and nominal values)
Residual ripple	< 40 mV <sub>pp</sub>
Signaling	
Signaling DC OK	LED
General data	
Weight / Dimensions W x H x D	0.17 kg / 22.5 x 99 x 107 mm
Spacing when mounting	Can be aligned: Horizontally 0 mm, vertically 50 mm
Connection method	Plug-in screw connection
Connection data solid / stranded / AWG	0.2 - 2.5 mm <sup>2</sup> / 0.2 - 2.5 mm <sup>2</sup> / 24 - 12
Degree of protection / Protection class	IP20 / II (in an enclosed control cabinet)
MTBF (EN 29500, 40°C)	> 500000 h
Ambient temperature (operation)	-25 °C ... 70 °C (> 60 °C derating)
Standards/regulations	
Insulation voltage input/output	3 kV (Routine test) / 4 kV (type test)
Electromagnetic compatibility	Conformance with EMC Directive 2004/108/EC
Electrical safety	EN 60950-1/VDE 0805 (SELV)
Electronic equipm. for electrical power installations	EN 50178/VDE 0160 (PELV)
Safe isolation	DIN VDE 0100-410, DIN VDE 0106-1010
UL approvals	UL/C-UL listed UL 508, UL/C-UL Recognized UL 60950, UL ANSI/ISA-12.12.01 Class I, Division 2, Groups A, B, C, D (Hazardous Location)
Limitation of harmonic line currents	EN 61000-3-2

Technical data		
100 V AC ... 240 V AC		
85 V AC ... 264 V AC / 90 V DC ... 350 V DC		
45 Hz ... 65 Hz / 0 Hz		
0.4 A (120 V AC) / 0.2 A (230 V AC)		
< 15 A / 1.5 A <sup>2</sup> s		
> 30 ms (120 V AC) / > 140 ms (230 V AC)		
5 V DC ±1%		
4.5 V DC ... 5.5 V DC (> 5 V constant capacity)		
3 A / 5 A		
Yes / Yes		
1 W / 5 W		
> 73 % (for 230 V AC and nominal values)		
< 40 mV <sub>pp</sub>		
LED		
0.17 kg / 22.5 x 99 x 107 mm		
Can be aligned: Horizontally 0 mm, vertically 50 mm		
Plug-in screw connection		
0.2 - 2.5 mm <sup>2</sup> / 0.2 - 2.5 mm <sup>2</sup> / 24 - 12		
IP20 / II (in an enclosed control cabinet)		
> 500000 h		
-25 °C ... 70 °C (> 60 °C derating)		
3 kV (Routine test) / 4 kV (type test)		
Conformance with EMC Directive 2004/108/EC		
EN 60950-1/VDE 0805 (SELV)		
EN 50178/VDE 0160 (PELV)		
DIN VDE 0100-410, DIN VDE 0106-1010		
UL/C-UL listed UL 508, UL/C-UL Recognized UL 60950, UL ANSI/ISA-12.12.01 Class I, Division 2, Groups A, B, C, D (Hazardous Location)		
EN 61000-3-2		

Ordering data	
Description	Power supply unit, primary-switched

Ordering data		
Type	Order No.	Pcs. / Pkt.
MINI-PS-100-240AC/ 5DC/3	2938714	1





Power supply,  
1 AC, 10 - 15 V DC, 2 A

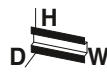

Power supply,  
1 AC, 10 - 15 V DC, 8 A



Power supply,  
1 AC, ±15 V DC, 1 A

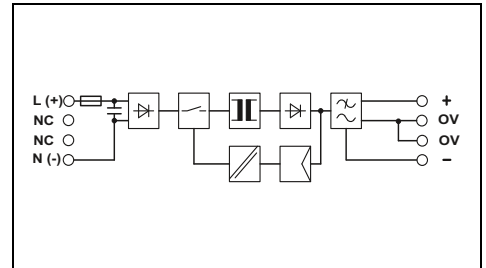
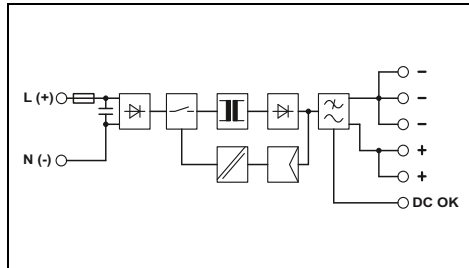
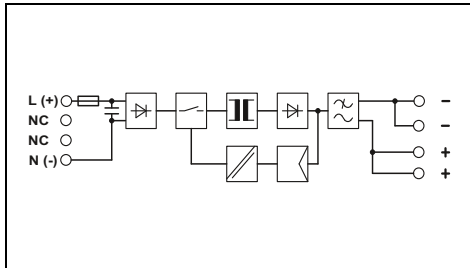

Technical data

100 V AC ... 240 V AC  
85 V AC ... 264 V AC / 90 V DC ... 350 V DC  
45 Hz ... 65 Hz / 0 Hz  
0.4 A (120 V AC) / 0.2 A (230 V AC)  
< 15 A / 1.7 A<sup>2</sup>s  
> 20 ms (120 V AC) / > 120 ms (230 V AC)

12 V DC ±1%  
10 V DC ... 15 V DC (> 12 V constant capacity)

2 A / 2.3 A  
Yes / Yes  
< 1 W / < 7 W  
> 86 % (for 230 V AC and nominal values)  
< 20 mV<sub>pp</sub>

LED

0.25 kg / 45 x 99 x 107 mm  
Can be aligned: Horizontally 0 mm, vertically 50 mm  
Plug-in screw connection  
0.2 - 2.5 mm<sup>2</sup> / 0.2 - 2.5 mm<sup>2</sup> / 24 - 12  
IP20 / II (in an enclosed control cabinet)  
> 507000 h  
-25 °C ... 70 °C (> 60 °C derating)

3 kV (Routine test) / 4 kV (type test)  
Conformance with EMC Directive 2004/108/EC  
EN 60950-1/VDE 0805 (SELV)  
EN 50178/VDE 0160 (PELV)  
DIN VDE 0100-410, DIN VDE 0106-1010  
UL/C-UL listed UL 508, UL/C-UL Recognized UL 60950,  
UL ANSI/ISA-12.12.01 Class I, Division 2, Groups A, B, C, D  
(Hazardous Location)

EN 61000-3-2

Ordering data

Type	Order No.	Pcs. / Pkt.
MINI-PS-100-240AC/10-15DC/2	2938756	1

Technical data

100 V AC ... 240 V AC  
85 V AC ... 264 V AC / 90 V DC ... 350 V DC  
45 Hz ... 65 Hz / 0 Hz  
1.3 A (120 V AC) / 0.8 A (230 V AC)  
< 15 A / 2.1 A<sup>2</sup>s  
> 20 ms (120 V AC) / > 20 ms (230 V AC)

12 V DC ±1%  
10 V DC ... 15 V DC (> 12 V constant capacity)

8 A / 6.6 A  
Yes / Yes  
< 2.5 W / < 12 W  
> 88 % (for 230 V AC and nominal values)  
< 40 mV<sub>pp</sub>

LED, active switching output

0.4 kg / 67.5 x 99 x 107 mm  
Can be aligned: Horizontally 0 mm, vertically 50 mm  
Plug-in screw connection  
0.2 - 2.5 mm<sup>2</sup> / 0.2 - 2.5 mm<sup>2</sup> / 24 - 12  
IP20 / II (in an enclosed control cabinet)  
> 984000 h  
-25 °C ... 70 °C (> 60 °C derating)

3 kV (Routine test) / 3 kV (type test)  
Conformance with EMC Directive 2004/108/EC  
EN 60950-1/VDE 0805 (SELV)  
EN 50178/VDE 0160 (PELV)  
DIN VDE 0100-410, DIN VDE 0106-1010  
UL/C-UL listed UL 508, UL/C-UL Recognized UL 60950,  
UL ANSI/ISA-12.12.01 Class I, Division 2, Groups A, B, C, D  
(Hazardous Location)

EN 61000-3-2

Ordering data

Type	Order No.	Pcs. / Pkt.
MINI-PS-100-240AC/10-15DC/8	2866297	1

Technical data

100 V AC ... 240 V AC  
85 V AC ... 264 V AC / 90 V DC ... 350 V DC  
45 Hz ... 65 Hz / 0 Hz  
0.6 A (120 V AC) / 0.4 A (230 V AC)  
< 35 A / 4 A<sup>2</sup>s  
> 30 ms (120 V AC) / > 150 ms (230 V AC)

± 15 V DC ±1%  
-

1 A / 1.5 A  
Yes / Yes  
2 W / 8 W  
> 80 % (for 230 V AC and nominal values)  
< 30 mV<sub>pp</sub>

LED

0.25 kg / 45 x 99 x 107 mm  
Can be aligned: Horizontally 0 mm, vertically 50 mm  
Plug-in screw connection  
0.2 - 2.5 mm<sup>2</sup> / 0.2 - 2.5 mm<sup>2</sup> / 24 - 12  
IP20 / II (in an enclosed control cabinet)  
> 500000 h  
-25 °C ... 70 °C (> 60 °C derating)

3 kV (Routine test) / 4 kV (type test)  
Conformance with EMC Directive 2004/108/EC  
EN 60950-1/VDE 0805 (SELV)  
EN 50178/VDE 0160 (PELV)  
DIN VDE 0100-410, DIN VDE 0106-1010  
UL/C-UL listed UL 508, UL/C-UL Recognized UL 60950,  
UL ANSI/ISA-12.12.01 Class I, Division 2, Groups A, B, C, D  
(Hazardous Location), NEC Class 2 as per UL 1310

EN 61000-3-2

Ordering data

Type	Order No.	Pcs. / Pkt.
MINI-PS-100-240AC/2X15DC/1	2938743	1

# Power supply units and UPS

## Power supply units

### UNO POWER power supply units - compact basic functionality

- More space in the control cabinet with up to 20% higher power density
- Height of housing is just 84 mm, suitable for all 120 mm control cabinets
- Maximum energy efficiency: energy savings with over 90% efficiency and extremely low idling losses under 0.3 W



Power supply, 1 AC, 24 DC, 30 W

N



Power supply, 1 AC, 24 DC, 60 W

N

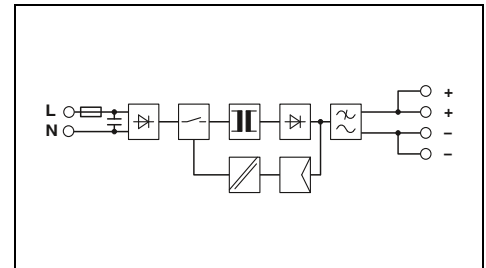
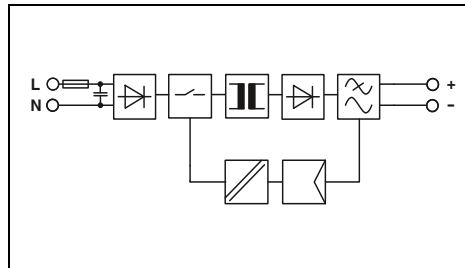

#### Technical data

Input data	
Nominal input voltage range	100 V AC ... 240 V AC
Input voltage range AC/DC	85 V AC ... 264 V AC
Frequency range	45 Hz ... 65 Hz
Current consumption (nominal load)	0.5 A (120 V AC) / 0.3 A (230 V AC)
Inrush current limitation at 25°C (typ.) / I <sup>2</sup> t	< 20 A / < 0.4 A <sup>2</sup> s
Mains buffering (I <sub>N</sub> , typ.)	> 35 ms (120 V AC) / > 140 ms (230 V AC)
Output data	
Nominal output voltage	24 V DC ±1%
Output current	1.25 A
Can be connected in parallel / series	yes, with redundancy module / Yes
Max. power dissipation (no load / nominal load)	< 0.3 W / < 5 W
Efficiency (typ.)	> 88 %
Residual ripple	< 60 mV <sub>pp</sub>
Signaling	
Signaling DC OK	LED
General data	
Weight / Dimensions W x H x D	0.15 kg / 22.5 x 90 x 84 mm
Spacing when mounting	Alignable: 0 mm horizontally, 30 mm vertically
Connection method	Screw connection
Connection data solid / stranded / AWG	0.2 - 2.5 mm <sup>2</sup> / 0.2 - 2.5 mm <sup>2</sup> / 24 - 14
Degree of protection / Protection class	IP20 / II (in an enclosed control cabinet)
MTBF (EN 29500, 40°C)	> 500000 h
Ambient temperature (operation)	-25 °C ... 70 °C (> 55° C derating)
Standards/regulations	
Insulation voltage input/output	3 kV AC (routine test) / 4 kV AC (type test)
Electromagnetic compatibility	Conformance with EMC Directive 2004/108/EC
Electrical safety	IEC 60950-1/VDE 0805 (SELV)
Electronic equipm. for electrical power installations	EN 50178/VDE 0160 (PELV)
Safe isolation	DIN VDE 0100-410 , DIN VDE 0106-1010
UL approvals	UL/C-UL listed UL 508 , UL/C-UL Recognized UL 60950 , NEC Class 2 as per UL 1310
Limitation of harmonic line currents	
EN 61000-3-2	

Technical data	
Nominal input voltage range	100 V AC ... 240 V AC
Input voltage range AC/DC	85 V AC ... 264 V AC
Frequency range	45 Hz ... 65 Hz
Current consumption (nominal load)	1 A (120 V AC) / 0.6 A (230 V AC)
Inrush current limitation at 25°C (typ.) / I <sup>2</sup> t	< 30 A / < 0.5 A <sup>2</sup> s
Mains buffering (I <sub>N</sub> , typ.)	> 20 ms (120 V AC) / > 85 ms (230 V AC)
Output data	
Nominal output voltage	24 V DC ±1%
Output current	2.5 A
Can be connected in parallel / series	yes, with redundancy module / Yes
Max. power dissipation (no load / nominal load)	< 0.3 W / < 7 W
Efficiency (typ.)	> 90 %
Residual ripple	< 30 mV <sub>pp</sub>
Signaling	
Signaling DC OK	LED
General data	
Weight / Dimensions W x H x D	0.2 kg / 35 x 90 x 84 mm
Spacing when mounting	Alignable: 0 mm horizontally, 30 mm vertically
Connection method	Screw connection
Connection data solid / stranded / AWG	0.2 - 2.5 mm <sup>2</sup> / 0.2 - 2.5 mm <sup>2</sup> / 24 - 12
Degree of protection / Protection class	IP20 / II (in an enclosed control cabinet)
MTBF (EN 29500, 40°C)	> 500000 h
Ambient temperature (operation)	-25 °C ... 70 °C (> 55° C derating)
Standards/regulations	
Insulation voltage input/output	3 kV AC (routine test) / 4 kV AC (type test)
Electromagnetic compatibility	Conformance with EMC Directive 2004/108/EC
Electrical safety	IEC 60950-1/VDE 0805 (SELV)
Electronic equipm. for electrical power installations	EN 50178/VDE 0160 (PELV)
Safe isolation	DIN VDE 0100-410 , DIN VDE 0106-1010
UL approvals	UL applied for
Limitation of harmonic line currents	
EN 61000-3-2	

#### Ordering data

Description	Type	Order No.	Pcs. / Pkt.
Power supply unit, primary-switched, 1-phase	UNO-PS/1AC/24DC/30W	2902991	1

#### Ordering data

Description	Type	Order No.	Pcs. / Pkt.
Power supply unit, primary-switched, 1-phase	UNO-PS/1AC/24DC/60W	2902992	1



Power supply, 1 AC, 24 DC, 100 W



Power supply, 1 AC, 12 DC, 30 W



Power supply, 1 AC, 12 DC, 55 W

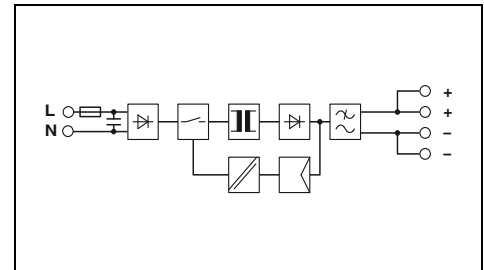
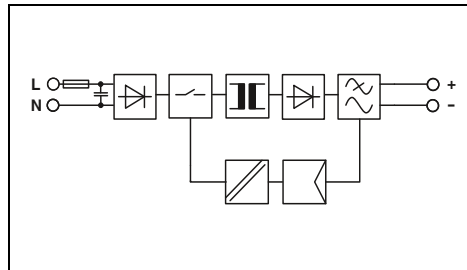
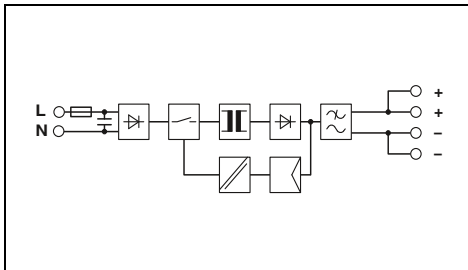

Technical data

100 V AC ... 240 V AC  
85 V AC ... 264 V AC  
45 Hz ... 65 Hz  
1.7 A (120 V AC) / 1 A (230 V AC)  
< 40 A / < 1.5 A<sup>2</sup>s  
> 20 ms (120 V AC) / > 90 ms (230 V AC)

24 V DC ±1%  
4.2 A  
yes, with redundancy module / Yes  
< 0.5 W / < 11 W  
> 90 %  
< 30 mV<sub>pp</sub>

LED

0.34 kg / 55 x 90 x 84 mm  
Alignable: 0 mm horizontally, 30 mm vertically  
Screw connection  
0.2 - 2.5 mm<sup>2</sup> / 0.2 - 2.5 mm<sup>2</sup> / 24 - 12  
IP20 / II (in an enclosed control cabinet)  
> 500000 h  
-25 °C ... 70 °C (> 55° C derating)

3 kV AC (routine test) / 4 kV AC (type test)  
Conformance with EMC Directive 2004/108/EC  
IEC 60950-1/VDE 0805 (SELV)  
EN 50178/VDE 0160 (PELV)  
DIN VDE 0100-410 , DIN VDE 0106-1010  
UL applied for

EN 61000-3-2

Technical data

100 V AC ... 240 V AC  
85 V AC ... 264 V AC  
45 Hz ... 65 Hz  
0.5 A (120 V AC) / 0.3 A (230 V AC)  
< 30 A / < 0.6 A<sup>2</sup>s  
> 20 ms (120 V AC) / > 120 ms (230 V AC)

12 V DC ±1%  
2.5 A  
yes, with redundancy module / Yes  
< 0.3 W / < 5.6 W  
> 87 %  
< 30 mV<sub>pp</sub>

LED

0.15 kg / 22.5 x 90 x 84 mm  
Alignable: 0 mm horizontally, 30 mm vertically  
Screw connection  
0.2 - 2.5 mm<sup>2</sup> / 0.2 - 2.5 mm<sup>2</sup> / 24 - 12  
IP20 / II (in an enclosed control cabinet)  
> 500000 h  
-25 °C ... 70 °C (> 55° C derating)

3 kV AC (routine test) / 4 kV AC (type test)  
Conformance with EMC Directive 2004/108/EC  
IEC 60950-1/VDE 0805 (SELV)  
EN 50178/VDE 0160 (PELV)  
DIN VDE 0100-410 , DIN VDE 0106-1010  
UL applied for

EN 61000-3-2

Technical data

100 V AC ... 240 V AC  
85 V AC ... 264 V AC  
45 Hz ... 65 Hz  
1 A (120 V AC) / 0.6 A (230 V AC)  
< 30 A / < 0.5 A<sup>2</sup>s  
> 25 ms (120 V AC) / > 125 ms (230 V AC)

12 V DC ±1%  
4.6 A  
yes, with redundancy module / Yes  
< 0.3 W / < 8 W  
> 90 %  
< 30 mV<sub>pp</sub>

LED

0.2 kg / 35 x 90 x 84 mm  
Alignable: 0 mm horizontally, 30 mm vertically  
Screw connection  
0.2 - 2.5 mm<sup>2</sup> / 0.2 - 2.5 mm<sup>2</sup> / 24 - 14  
IP20 / II (in an enclosed control cabinet)  
> 500000 h  
-25 °C ... 70 °C (> 55° C derating)

3 kV AC (routine test) / 4 kV AC (type test)  
Conformance with EMC Directive 2004/108/EC  
IEC 60950-1/VDE 0805 (SELV)  
EN 50178/VDE 0160 (PELV)  
DIN VDE 0100-410 , DIN VDE 0106-1010  
UL applied for

EN 61000-3-2

Ordering data

Type	Order No.	Pcs. / Pkt.
UNO-PS/1AC/24DC/100W	2902993	1

Ordering data

Type	Order No.	Pcs. / Pkt.
UNO-PS/1AC/12DC/30W	2902998	1

Ordering data

Type	Order No.	Pcs. / Pkt.
UNO-PS/1AC/12DC/55W	2902999	1

# Power supply units and UPS

## Power supply units

### STEP POWER - power supply units for distributor boards and flat control panels

#### STEP POWER, 1 AC, 24 V DC

- Flexible assembly by simply snapping the product onto the DIN rail or screwing it onto an even surface
- Energy savings thanks to maximum energy efficiency and incredibly low no-load losses
- Wide temperature range from -25°C to +70°C
- Reliable power supply thanks to the high MTBF (mean time between failures) of more than 500,000 hours and the UI characteristic curve

#### STEP POWER, 24 V DC, 0.5 A

- Slim design with a design width of just 18 mm (1 pitch)

#### STEP POWER, 24 V DC, 0.75 A

- Flat design with a depth of just 43 mm

#### STEP POWER, 48 V AC, 0.5 A

- Connection to 48 V AC operating networks
- Slim design with a design width of just 18 mm (1 pitch)



Power supply,  
1 AC, 24 V DC, 0.5 A

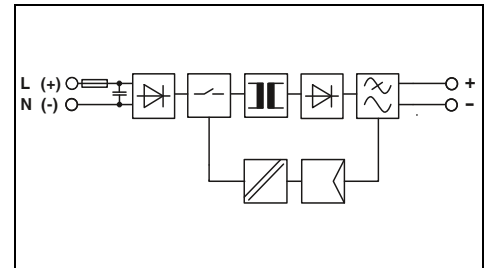

### Technical data

<b>Input data</b>	100 V AC ... 240 V AC 85 V AC ... 264 V AC / 95 V DC ... 250 V DC 45 Hz ... 65 Hz / 0 Hz 0.28 A (120 V AC) / 0.13 A (230 V AC) < 15 A / < 0.1 A <sup>2</sup> s > 15 ms (120 V AC) / > 90 ms (230 V AC)
<b>Output data</b>	24 V DC ±1% 0.5 A Yes / Yes < 0.3 W / < 2.2 W > 84 % (for 230 V AC and nominal values) < 20 mV <sub>pp</sub>
<b>Signaling</b>	LED
<b>General data</b>	0.07 kg / 18 x 90 x 61 mm Alignable: 0 mm horizontally, 30 mm vertically Screw connection 0.2 - 2.5 mm <sup>2</sup> / 0.2 - 2.5 mm <sup>2</sup> / 24 - 12 IP20 / II (in an enclosed control cabinet) > 1567000 h -25 °C ... 70 °C (> 55 °C derating)
<b>Standards/regulations</b>	3.75 kV AC (routine test) / 4 kV AC (type test) Conformance with EMC Directive 2004/108/EC IEC 60950-1/VDE 0805 (SELV) EN 50178/VDE 0160 (PELV) DIN VDE 0100-410, DIN VDE 0106-1010 UL/C-UL listed UL 508, UL/C-UL Recognized UL 60950, NEC Class 2 as per UL 1310
<b>Electromagnetic compatibility</b>	
<b>Electrical safety</b>	
<b>Electronic equipm. for electrical power installations</b>	
<b>Safe isolation</b>	
<b>UL approvals</b>	
<b>Limitation of harmonic line currents</b>	EN 61000-3-2

### Ordering data

Description	Type	Order No.	Pcs. / Pkt.
Power supply unit, primary-switched	STEP-PS/ 1AC/24DC/0.5	2868596	1



Power supply,  
1 AC, 24 V DC, 0.75 A,  
flat design

UL1950, CE, ClassNK, CB  
Ex: UL1950



Power supply,  
1 AC, 24 V DC, 0.75 A

UL1950, CE, BSH, ClassNK, CB  
Ex: UL1950



Power supply,  
48 V AC, 24 V DC, 0.5 A

UL1950, CE

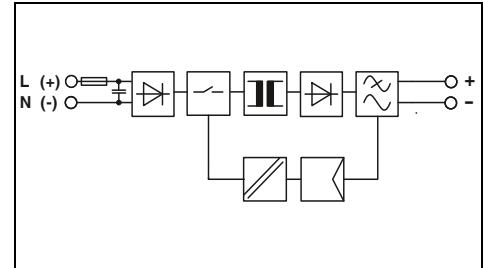
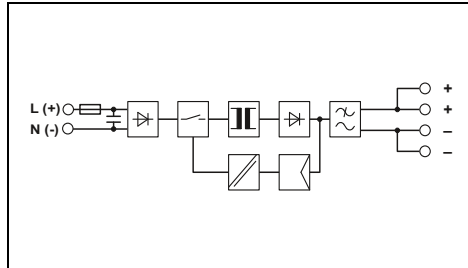
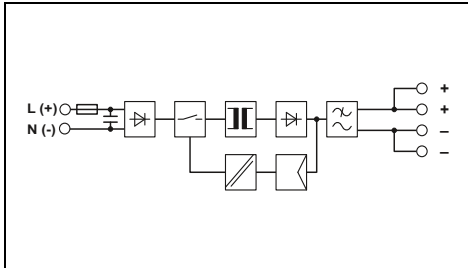

Technical data

100 V AC ... 240 V AC  
85 V AC ... 264 V AC / 95 V DC ... 250 V DC  
45 Hz ... 65 Hz / 0 Hz  
0.3 A (120 V AC) / 0.25 A (230 V AC)  
< 15 A / < 0.1 A<sup>2</sup>s  
> 15 ms (120 V AC) / > 70 ms (230 V AC)

24 V DC ±1%  
0.75 A  
Yes / Yes  
< 0.5 W / < 3.6 W  
> 84 % (for 230 V AC and nominal values)  
< 75 mV<sub>pp</sub>

LED

0.11 kg / 36 x 90 x 43 mm  
Alignable: 0 mm horizontally, 30 mm vertically  
Screw connection  
0.2 - 2.5 mm<sup>2</sup> / 0.2 - 2.5 mm<sup>2</sup> / 24 - 12  
IP20 / II (in an enclosed control cabinet)  
> 926000 h  
-25 °C ... 70 °C (> 55° C derating)

3.75 kV AC (routine test) / 4 kV AC (type test)

Conformance with EMC Directive 2004/108/EC  
IEC 60950-1/VDE 0805 (SELV)  
EN 50178/VDE 0160 (PELV)  
DIN VDE 0100-410, DIN VDE 0106-1010  
UL/C-UL listed UL 508, UL/C-UL Recognized UL 60950,  
NEC Class 2 as per UL 1310, UL ANSI/ISA-12.12.01 Class I,  
Division 2, Groups A, B, C, D (Hazardous Location)

EN 61000-3-2

Ordering data

Type	Order No.	Pcs. / Pkt.
STEP-PS/ 1AC/24DC/0.75/FL	2868622	1

Technical data

100 V AC ... 240 V AC  
85 V AC ... 264 V AC / 95 V DC ... 250 V DC  
45 Hz ... 65 Hz / 0 Hz  
0.3 A (120 V AC) / 0.2 A (230 V AC)  
< 15 A / < 0.1 A<sup>2</sup>s  
> 15 ms (120 V AC) / > 70 ms (230 V AC)

24 V DC ±1%  
0.75 A  
Yes / Yes  
< 0.5 W / 3.6 W  
> 84 % (for 230 V AC and nominal values)  
< 75 mV<sub>pp</sub>

LED

0.11 kg / 36 x 90 x 61 mm  
Alignable: 0 mm horizontally, 30 mm vertically  
Screw connection  
0.2 - 2.5 mm<sup>2</sup> / 0.2 - 2.5 mm<sup>2</sup> / 24 - 12  
IP20 / II (in an enclosed control cabinet)  
> 926000 h  
-25 °C ... 70 °C (> 55° C derating)

3.75 kV AC (routine test) / 4 kV AC (type test)

Conformance with EMC Directive 2004/108/EC  
IEC 60950-1/VDE 0805 (SELV)  
EN 50178/VDE 0160 (PELV)  
DIN VDE 0100-410, DIN VDE 0106-1010  
UL/C-UL listed UL 508, UL/C-UL Recognized UL 60950,  
NEC Class 2 as per UL 1310, UL ANSI/ISA-12.12.01 Class I,  
Division 2, Groups A, B, C, D (Hazardous Location)

EN 61000-3-2

Ordering data

Type	Order No.	Pcs. / Pkt.
STEP-PS/ 1AC/24DC/0.75	2868635	1

Technical data

48 V AC  
43 V AC ... 52 V AC / 60 V DC ... 80 V DC  
45 Hz ... 65 Hz / 0 Hz  
0.5 A (43 V AC) / 0.45 A (48 V AC)  
< 10 A / < 0.1 A<sup>2</sup>s  
> 15 ms (48 V AC) / > 20 ms (52 V AC)

24 V DC ±1%  
0.5 A  
Yes / Yes  
< 0.3 W / < 3.4 W  
> 81 % (for 48 V AC and nominal values)  
< 30 mV<sub>pp</sub>

LED

0.07 kg / 18 x 90 x 61 mm  
Alignable: 0 mm horizontally, 30 mm vertically  
Screw connection  
0.2 - 2.5 mm<sup>2</sup> / 0.2 - 2.5 mm<sup>2</sup> / 24 - 12  
IP20 / II (in an enclosed control cabinet)  
> 1860000 h  
-25 °C ... 70 °C (> 55° C derating)

3.75 kV AC (routine test) / 4 kV AC (type test)

Conformance with EMC Directive 2004/108/EC  
IEC 60950-1/VDE 0805 (SELV)  
EN 50178/VDE 0160 (PELV)  
DIN VDE 0100-410, DIN VDE 0106-1010  
UL/C-UL listed UL 508, UL/C-UL Recognized UL 60950,  
NEC Class 2 as per UL 1310

EN 61000-3-2

Ordering data

Type	Order No.	Pcs. / Pkt.
STEP-PS/48AC/24DC/0.5	2868716	1

## Power supply units

### STEP POWER - power supply units for distributor boards and flat control panels

#### STEP POWER, 1 AC, 24 V DC

- Flexible assembly by simply snapping the product onto the DIN rail or screwing it onto an even surface
- Energy savings thanks to maximum energy efficiency and incredibly low no-load losses
- Wide temperature range from -25°C to +70°C
- Reliable power supply thanks to the high MTBF (mean time between failures) of more than 500,000 hours and the UI characteristic curve
- Adjustable output voltage of 22.5 to 29.5 V DC

#### STEP POWER, 100 W

- Output power limited to 100 W: specifically for applications that require certification according to UL 1310/508 Listed Class 2
- Approved for DeviceNet™



**Power supply,  
1 AC, 24 V DC, 1.75 A**

UL<sup>®</sup> BSH<sup>®</sup> ClassNK<sup>®</sup> CB<sup>®</sup>  
Ex: UL<sup>®</sup>

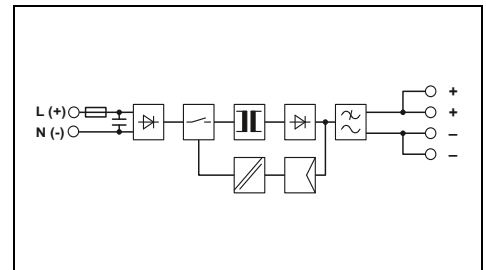

### Technical data

<b>Input data</b>	100 V AC ... 240 V AC 85 V AC ... 264 V AC / 95 V DC ... 250 V DC 45 Hz ... 65 Hz / 0 Hz 0.6 A (120 V AC) / 0.3 A (230 V AC) < 15 A / < 0.6 A <sup>2</sup> s > 25 ms (120 V AC) / > 150 ms (230 V AC)
<b>Output data</b>	24 V DC ±1% 22.5 V DC ... 29.5 V DC (> 24 V constant capacity)
<b>Output current</b>	1.75 A Yes / Yes < 0.7 W / 5 W > 89 % (for 230 V AC and nominal values) < 60 mV <sub>pp</sub>
<b>Signaling</b>	LED
<b>General data</b>	0.19 kg / 54 x 90 x 61 mm Alignable: 0 mm horizontally, 30 mm vertically Screw connection 0.2 - 2.5 mm <sup>2</sup> / 0.2 - 2.5 mm <sup>2</sup> / 24 - 12 IP20 / II (in an enclosed control cabinet) > 1569000 h -25 °C ... 70 °C (> 55 °C derating)
<b>Standards/regulations</b>	3.75 kV AC (routine test) / 4 kV AC (type test) Conformance with EMC Directive 2004/108/EC IEC 60950-1/VDE 0805 (SELV) EN 50178/VDE 0160 (PELV) DIN VDE 0100-410, DIN VDE 0106-1010 UL/C-UL listed UL 508, UL/C-UL Recognized UL 60950, NEC Class 2 as per UL 1310, UL ANSI/ISA-12.12.01 Class I, Division 2, Groups A, B, C, D (Hazardous Location)
<b>Limitation of harmonic line currents</b>	EN 61000-3-2

### Ordering data

Description	Type	Order No.	Pcs. / Pkt.
<b>Power supply unit, primary-switched</b>	<b>STEP-PS/ 1AC/24DC/1.75</b>	<b>2868648</b>	<b>1</b>



Power supply,  
1 AC, 24 V DC, 2.5 A

UL, CE, BSH, ClassNK, CB  
Ex: U

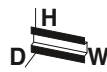

Power supply,  
1 AC, 24 V DC, 100 W  
NEC Class 2

UL, CE, BSH, CB  
Ex: U



Power supply,  
1 AC, 24 V DC, 4.2 A

UL, CE, BSH, ClassNK, CB  
Ex: U

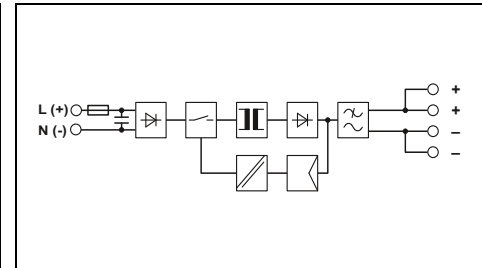
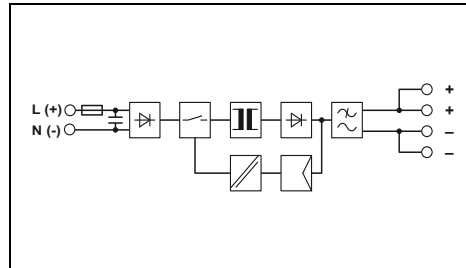
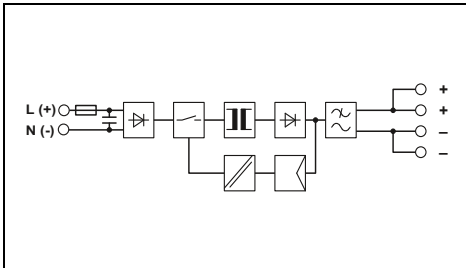

Technical data

100 V AC ... 240 V AC  
85 V AC ... 264 V AC / 95 V DC ... 250 V DC  
45 Hz ... 65 Hz / 0 Hz  
0.8 A (120 V AC) / 0.4 A (230 V AC)  
< 15 A / < 0.6 A<sup>2</sup>s  
> 20 ms (120 V AC) / > 100 ms (230 V AC)

24 V DC ±1%  
22.5 V DC ... 29.5 V DC (> 24 V constant capacity)

2.5 A  
Yes / Yes  
< 0.7 W / 9.9 W  
> 86 % (for 230 V AC and nominal values)  
< 80 mV<sub>pp</sub>

LED

0.27 kg / 72 x 90 x 61 mm  
Alignable: 0 mm horizontally, 30 mm vertically  
Screw connection  
0.2 - 2.5 mm<sup>2</sup> / 0.2 - 2.5 mm<sup>2</sup> / 24 - 12  
IP20 / II (in an enclosed control cabinet)  
> 1061000 h  
-25 °C ... 70 °C (> 55 °C derating)

3.75 kV AC (routine test) / 4 kV AC (type test)

Conformance with EMC Directive 2004/108/EC  
IEC 60950-1/VDE 0805 (SELV)  
EN 50178/VDE 0160 (PELV)  
DIN VDE 0100-410, DIN VDE 0106-1010  
UL/C-UL listed UL 508, UL/C-UL Recognized UL 60950,  
NEC Class 2 as per UL 1310, UL ANSI/ISA-12.12.01 Class I,  
Division 2, Groups A, B, C, D (Hazardous Location)

EN 61000-3-2

Technical data

100 V AC ... 240 V AC  
85 V AC ... 264 V AC / 95 V DC ... 250 V DC  
45 Hz ... 65 Hz / 0 Hz  
1.3 A (120 V AC) / 0.8 A (230 V AC)  
< 15 A / < 1 A<sup>2</sup>s  
> 25 ms (120 V AC) / > 120 ms (230 V AC)

24 V DC ±1%  
22.5 V DC ... 29.5 V DC (> 24 V constant capacity)

3.8 A  
No / No  
< 0.7 W / 11.8 W  
> 88 % (for 230 V AC and nominal values)  
< 80 mV<sub>pp</sub>

LED

0.33 kg / 90 x 90 x 61 mm  
Alignable: 0 mm horizontally, 30 mm vertically  
Screw connection  
0.2 - 2.5 mm<sup>2</sup> / 0.2 - 2.5 mm<sup>2</sup> / 24 - 12  
IP20 / II (in an enclosed control cabinet)  
> 897000 h  
-25 °C ... 70 °C (> 55 °C derating)

3.75 kV AC (routine test) / 4 kV AC (type test)

Conformance with EMC Directive 2004/108/EC  
IEC 60950-1/VDE 0805 (SELV)  
EN 50178/VDE 0160 (PELV)  
DIN VDE 0100-410, DIN VDE 0106-1010  
UL/C-UL listed UL 508, UL/C-UL Recognized UL 60950,  
NEC Class 2 as per UL 1310, UL ANSI/ISA-12.12.01 Class I,  
Division 2, Groups A, B, C, D (Hazardous Location)

EN 61000-3-2

Technical data

100 V AC ... 240 V AC  
85 V AC ... 264 V AC / 95 V DC ... 250 V DC  
45 Hz ... 65 Hz / 0 Hz  
1.3 A (120 V AC) / 0.8 A (230 V AC)  
< 15 A / < 1 A<sup>2</sup>s  
> 20 ms (120 V AC) / > 100 ms (230 V AC)

24 V DC ±1%  
22.5 V DC ... 29.5 V DC (> 24 V constant capacity)

4.2 A  
Yes / Yes  
< 0.7 W / 13.2 W  
> 88 % (for 230 V AC and nominal values)  
< 40 mV<sub>pp</sub>

LED

0.33 kg / 90 x 90 x 61 mm  
Alignable: 0 mm horizontally, 30 mm vertically  
Screw connection  
0.2 - 2.5 mm<sup>2</sup> / 0.2 - 2.5 mm<sup>2</sup> / 24 - 12  
IP20 / II (in an enclosed control cabinet)  
> 897498 h  
-25 °C ... 70 °C (> 55 °C derating)

3.75 kV AC (routine test) / 4 kV AC (type test)

Conformance with EMC Directive 2004/108/EC  
IEC 60950-1/VDE 0805 (SELV)  
EN 50178/VDE 0160 (PELV)  
DIN VDE 0100-410, DIN VDE 0106-1010  
UL/C-UL listed UL 508, UL/C-UL Recognized UL 60950,  
UL ANSI/ISA-12.12.01 Class I, Division 2, Groups A, B, C, D  
(Hazardous Location)

EN 61000-3-2

Ordering data

Type	Order No.	Pcs. / Pkt.
STEP-PS/ 1AC/24DC/2.5	2868651	1

Ordering data

Type	Order No.	Pcs. / Pkt.
STEP-PS/ 1AC/24DC/3.8/C2LPS	2868677	1

Ordering data

Type	Order No.	Pcs. / Pkt.
STEP-PS/ 1AC/24DC/4.2	2868664	1

# Power supply units and UPS

## Power supply units

### STEP POWER - power supply units for distributor boards and flat control panels

#### STEP POWER, 1 AC, 5 to 48 V DC

- Flexible assembly by simply snapping the product onto the DIN rail or screwing it onto an even surface
- Energy savings thanks to maximum energy efficiency and incredibly low no-load losses
- Wide temperature range from -25°C to +70°C
- Reliable power supply thanks to the high MTBF (mean time between failures) of more than 500,000 hours and the UI characteristic curve

#### STEP POWER, 5 V DC, 2 A

- Slim design with a design width of just 18 mm (1 pitch)

#### STEP POWER, 5 V DC, 6.5 A

- Adjustable output voltage of 4 to 6.5 V DC

#### STEP POWER, 15 V DC, 4 A

- Adjustable output voltage of 10 to 16.5 V DC

#### STEP POWER, 48 V DC, 2 A

- Adjustable output voltage of 30 to 56 V DC



N

Power supply,  
1 AC, 5 V DC, 2 A

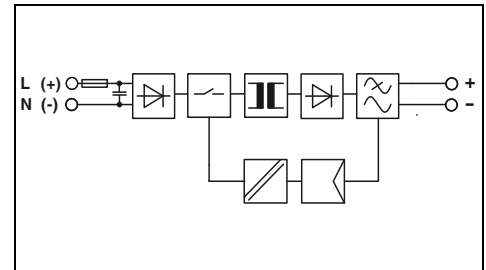

Technical data	
<b>Input data</b>	
Nominal input voltage range	100 V AC ... 240 V AC
Input voltage range AC/DC	85 V AC ... 264 V AC / 95 V DC ... 250 V DC
Frequency range	45 Hz ... 65 Hz / 0 Hz
Current consumption (nominal load)	0.2 A (120 V AC) / 0.13 A (230 V AC)
Inrush current limitation at 25°C (typ.) / I <sup>2</sup> t	< 15 A / < 0.1 A <sup>2</sup> s
Mains buffering (I <sub>N</sub> , typ.)	> 20 ms (120 V AC) / > 100 ms (230 V AC)
<b>Output data</b>	
Nominal output voltage	5 V DC ±1%
Setting range of the output voltage	-
<b>Output current</b>	
Can be connected in parallel / series	2 A Yes / Yes
Max. power dissipation (no load / nominal load)	< 0.4 W / < 2.7 W
Efficiency (typ.)	> 80 % (for 230 V AC and nominal values)
Residual ripple	< 20 mV <sub>pp</sub>
<b>Signaling</b>	
Signaling DC OK	LED
<b>General data</b>	
Weight / Dimensions W x H x D	0.07 kg / 18 x 90 x 61 mm
Spacing when mounting	Alignable: 0 mm horizontally, 30 mm vertically
Connection method	Screw connection
Connection data solid / stranded / AWG	0.2 - 2.5 mm <sup>2</sup> / 0.2 - 2.5 mm <sup>2</sup> / 24 - 12
Degree of protection / Protection class	IP20 / II (in an enclosed control cabinet)
MTBF (EN 29500, 40°C)	> 500000 h
Ambient temperature (operation)	-25 °C ... 70 °C (> 55° C derating)
<b>Standards/regulations</b>	
Insulation voltage input/output	3.75 kV AC (routine test) / 4 kV AC (type test)
<b>Electromagnetic compatibility</b>	
Electrical safety	Conformance with EMC Directive 2004/108/EC
Electronic equipm. for electrical power installations	IEC 60950-1/VDE 0805 (SELV)
Safe isolation	EN 50178/VDE 0160 (PELV)
UL approvals	DIN VDE 0100-410, DIN VDE 0106-1010 UL/C-UL listed UL 508, UL/C-UL Recognized UL 60950, NEC Class 2 as per UL 1310
<b>Limitation of harmonic line currents</b>	EN 61000-3-2

Ordering data			
Description	Type	Order No.	Pcs. / Pkt.
Power supply unit, primary-switched, 1-phase	STEP-PS/ 1AC/5DC/2	2320513	1





Power supply,  
1 AC, 5 V DC, 6.5 A

UL CE SA IES R ClassNK CB  
Ex: U



Power supply,  
1 AC, 15 V DC, 4 A

UL CE SA IES R ClassNK CB  
Ex: U



Power supply,  
1 AC, 48 V DC, 2 A

UL CE SA IES R ClassNK CB  
Ex: U

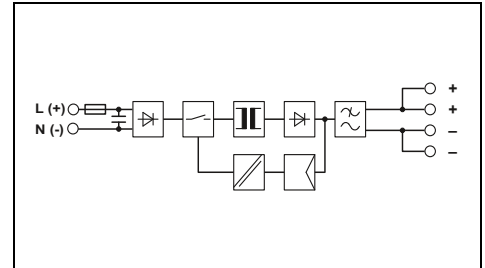
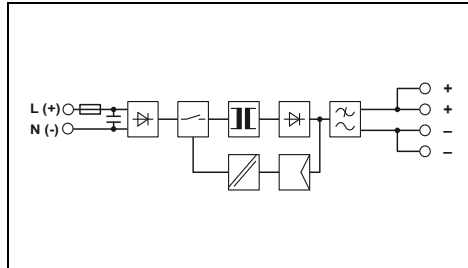
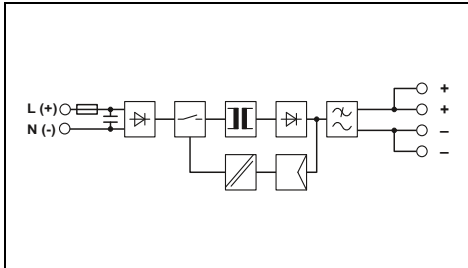

Technical data	
100 V AC ... 240 V AC 85 V AC ... 264 V AC / 95 V DC ... 250 V DC 45 Hz ... 65 Hz / 0 Hz 0.5 A (120 V AC) / 0.3 A (230 V AC) < 15 A / < 0.6 A <sup>2</sup> s > 25 ms (120 V AC) / > 140 ms (230 V AC)	
5 V DC ±1% 4 V DC ... 6.5 V DC (> 5 V constant capacity)	
6.5 A Yes / Yes < 0.4 W / 8.1 W > 80 % (for 230 V AC and nominal values) < 50 mV <sub>pp</sub>	
LED	
0.27 kg / 72 x 90 x 61 mm Alignable: 0 mm horizontally, 30 mm vertically Screw connection 0.2 - 2.5 mm <sup>2</sup> / 0.2 - 2.5 mm <sup>2</sup> / 24 - 12 IP20 / II (in an enclosed control cabinet) > 1111000 h -25 °C ... 70 °C (> 55° C derating)	
3.75 kV AC (routine test) / 4 kV AC (type test)	
Conformance with EMC Directive 2004/108/EC IEC 60950-1/VDE 0805 (SELV) EN 50178/VDE 0160 (PELV) DIN VDE 0100-410, DIN VDE 0106-1010 UL/C-UL listed UL 508, UL/C-UL Recognized UL 60950, UL ANSI/ISA-12.12.01 Class I, Division 2, Groups A, B, C, D (Hazardous Location) EN 61000-3-2	

Technical data	
100 V AC ... 240 V AC 85 V AC ... 264 V AC / 95 V DC ... 250 V DC 45 Hz ... 65 Hz / 0 Hz 0.8 A (120 V AC) / 0.5 A (230 V AC) < 15 A / < 0.6 A <sup>2</sup> s > 27 ms (120 V AC) / > 120 ms (230 V AC)	
15 V DC ±1% 10 V DC ... 16.5 V DC (> 15 V constant capacity)	
4 A Yes / Yes < 0.5 W / 8.6 W > 87 % (for 230 V AC and nominal values) < 55 mV <sub>pp</sub>	
LED	
0.27 kg / 72 x 90 x 61 mm Alignable: 0 mm horizontally, 30 mm vertically Screw connection 0.2 - 2.5 mm <sup>2</sup> / 0.2 - 2.5 mm <sup>2</sup> / 24 - 12 IP20 / II (in an enclosed control cabinet) > 1134000 h -25 °C ... 70 °C (> 55° C derating)	
3.75 kV AC (routine test) / 4 kV AC (type test)	
Conformance with EMC Directive 2004/108/EC IEC 60950-1/VDE 0805 (SELV) EN 50178/VDE 0160 (PELV) DIN VDE 0100-410, DIN VDE 0106-1010 UL/C-UL listed UL 508, UL/C-UL Recognized UL 60950, UL ANSI/ISA-12.12.01 Class I, Division 2, Groups A, B, C, D (Hazardous Location) EN 61000-3-2	

Technical data	
100 V AC ... 240 V AC 85 V AC ... 264 V AC / 95 V DC ... 250 V DC 45 Hz ... 65 Hz / 0 Hz 1.3 A (120 V AC) / 0.8 A (230 V AC) < 15 A / < 1.4 A <sup>2</sup> s > 20 ms (120 V AC) / > 120 ms (230 V AC)	
48 V DC ±1% 30 V DC ... 56 V DC (> 48 V constant capacity)	
2 A Yes / Yes < 0.9 W / 9.6 W > 90 % (for 230 V AC and nominal values) < 30 mV <sub>pp</sub>	
LED	
0.33 kg / 90 x 90 x 61 mm Alignable: 0 mm horizontally, 30 mm vertically Screw connection 0.2 - 2.5 mm <sup>2</sup> / 0.2 - 2.5 mm <sup>2</sup> / 24 - 12 IP20 / II (in an enclosed control cabinet) > 1048000 h -25 °C ... 70 °C (> 55° C derating)	
3.75 kV AC (routine test) / 4 kV AC (type test)	
Conformance with EMC Directive 2004/108/EC IEC 60950-1/VDE 0805 (SELV) EN 50178/VDE 0160 (PELV) DIN VDE 0100-410, DIN VDE 0106-1010 UL/C-UL listed UL 508, UL/C-UL Recognized UL 60950, UL ANSI/ISA-12.12.01 Class I, Division 2, Groups A, B, C, D (Hazardous Location) EN 61000-3-2	

Ordering data		
Type	Order No.	Pcs. / Pkt.
STEP-PS/ 1AC/ 5DC/6.5	2868541	1

Ordering data		
Type	Order No.	Pcs. / Pkt.
STEP-PS/ 1AC/15DC/4	2868619	1

Ordering data		
Type	Order No.	Pcs. / Pkt.
STEP-PS/ 1AC/48DC/2	2868680	1

# Power supply units and UPS

## Power supply units

### STEP POWER - power supply units for distributor boards and flat control panels

#### STEP POWER, 1 AC, 12 V DC

- Flexible assembly by simply snapping the product onto the DIN rail or screwing it onto an even surface
- Energy savings thanks to maximum energy efficiency and incredibly low no-load losses
- Wide temperature range from -25°C to +70°C
- Reliable power supply thanks to the high MTBF (mean time between failures) of more than 500,000 hours and the UI characteristic curve



Power supply,  
1 AC, 12 V DC, 1 A

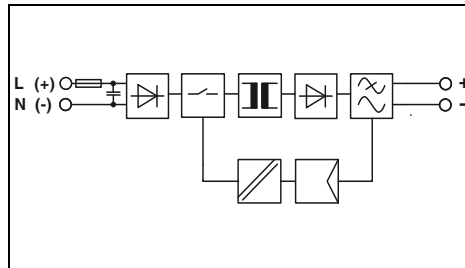

#### Technical data

Input data	
Nominal input voltage range	100 V AC ... 240 V AC
Input voltage range AC/DC	85 V AC ... 264 V AC / 95 V DC ... 250 V DC
Frequency range	45 Hz ... 65 Hz / 0 Hz
Current consumption (nominal load)	0.26 A (120 V AC) / 0.13 A (230 V AC)
Inrush current limitation at 25°C (typ.) / I <sup>2</sup> t	< 15 A / < 0.1 A <sup>2</sup> s
Mains buffering (I <sub>N</sub> , typ.)	> 15 ms (120 V AC) / > 90 ms (230 V AC)
Output data	
Nominal output voltage	12 V DC ±1%
Setting range of the output voltage	-
Output current	1 A
Can be connected in parallel / series	Yes / Yes
Max. power dissipation (no load / nominal load)	< 0.4 W / < 2.8 W
Efficiency (typ.)	> 83 % (for 230 V AC and nominal values)
Residual ripple	< 20 mV <sub>pp</sub>
Signaling	
Signaling DC OK	LED
General data	
Weight / Dimensions W x H x D	0.07 kg / 18 x 90 x 61 mm
Spacing when mounting	Alignable: 0 mm horizontally, 30 mm vertically
Connection method	Screw connection
Connection data solid / stranded / AWG	0.2 - 2.5 mm <sup>2</sup> / 0.2 - 2.5 mm <sup>2</sup> / 24 - 12
Degree of protection / Protection class	IP20 / II (in an enclosed control cabinet)
MTBF (EN 29500, 40°C)	> 1478000 h
Ambient temperature (operation)	-25 °C ... 70 °C (> 55 °C derating)
Standards/regulations	
Insulation voltage input/output	3.75 kV AC (routine test) / 4 kV AC (type test)
Electromagnetic compatibility	
Electrical safety	Conformance with EMC Directive 2004/108/EC
Electronic equipm. for electrical power installations	IEC 60950-1/VDE 0805 (SELV)
Safe isolation	EN 50178/VDE 0160 (PELV)
UL approvals	DIN VDE 0100-410, DIN VDE 0106-1010
	UL/C-UL listed UL 508, UL/C-UL Recognized UL 60950, NEC Class 2 as per UL 1310
Limitation of harmonic line currents	EN 61000-3-2



Power supply,  
1 AC, 12 V DC, 1.5 A,  
flat design

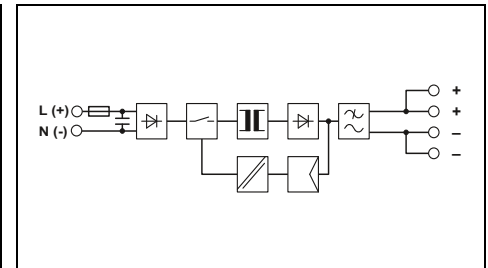

#### Technical data

Input data	
Nominal input voltage range	100 V AC ... 240 V AC
Input voltage range AC/DC	85 V AC ... 264 V AC / 95 V DC ... 250 V DC
Frequency range	45 Hz ... 65 Hz / 0 Hz
Current consumption (nominal load)	0.33 A (120 V AC) / 0.18 A (230 V AC)
Inrush current limitation at 25°C (typ.) / I <sup>2</sup> t	< 15 A / < 0.1 A <sup>2</sup> s
Mains buffering (I <sub>N</sub> , typ.)	> 15 ms (120 V AC) / > 70 ms (230 V AC)
Output data	
Nominal output voltage	12 V DC ±1%
Setting range of the output voltage	-
Output current	1.5 A
Can be connected in parallel / series	Yes / Yes
Max. power dissipation (no load / nominal load)	< 0.4 W / < 3.2 W
Efficiency (typ.)	> 84 % (for 230 V AC and nominal values)
Residual ripple	< 75 mV <sub>pp</sub>
Signaling	
Signaling DC OK	LED
General data	
Weight / Dimensions W x H x D	0.07 kg / 36 x 90 x 43 mm
Spacing when mounting	Alignable: 0 mm horizontally, 30 mm vertically
Connection method	Screw connection
Connection data solid / stranded / AWG	0.2 - 2.5 mm <sup>2</sup> / 0.2 - 2.5 mm <sup>2</sup> / 24 - 12
Degree of protection / Protection class	IP20 / II (in an enclosed control cabinet)
MTBF (EN 29500, 40°C)	> 1800000 h
Ambient temperature (operation)	-25 °C ... 70 °C (> 55 °C derating)
Standards/regulations	
Insulation voltage input/output	3.75 kV AC (routine test) / 4 kV AC (type test)
Electromagnetic compatibility	
Electrical safety	Conformance with EMC Directive 2004/108/EC
Electronic equipm. for electrical power installations	IEC 60950-1/VDE 0805 (SELV)
Safe isolation	EN 50178/VDE 0160 (PELV)
UL approvals	DIN VDE 0100-410, DIN VDE 0106-1010
	UL/C-UL listed UL 508, UL/C-UL Recognized UL 60950, NEC Class 2 as per UL 1310, UL ANSI/ISA-12.12.01 Class I, Division 2, Groups A, B, C, D (Hazardous Location)
Limitation of harmonic line currents	EN 61000-3-2

#### Ordering data

Description	Type	Order No.	Pcs. / Pkt.
Power supply unit, primary-switched	STEP-PS/ 1AC/12DC/1	2868538	1

#### Ordering data

Description	Type	Order No.	Pcs. / Pkt.
Power supply unit, primary-switched	STEP-PS/ 1AC/12DC/1.5/FL	2868554	1



Power supply,  
1 AC, 12 V DC, 1.5 A

UL CE ClassNK CB  
Ex: U



Power supply,  
1 AC, 12 V DC, 3 A

UL CE ClassNK CB  
Ex: U



Power supply,  
1 AC, 12 V DC, 5 A

UL CE ClassNK CB  
Ex: U

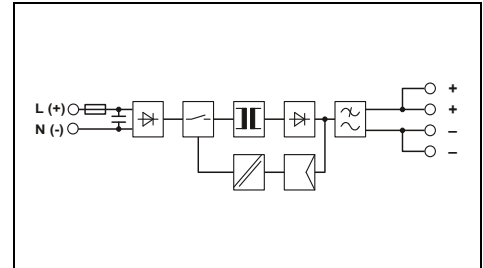
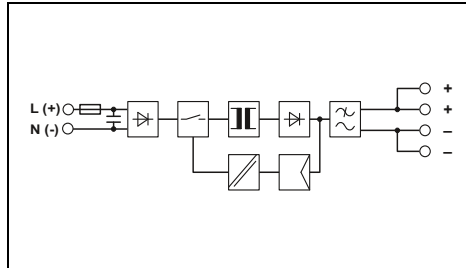
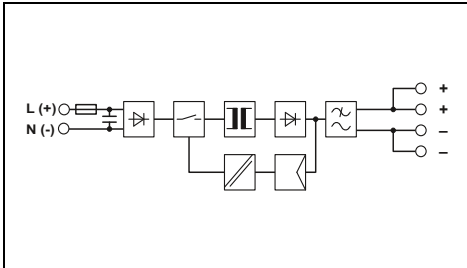

Technical data

100 V AC ... 240 V AC  
85 V AC ... 264 V AC / 95 V DC ... 250 V DC  
45 Hz ... 65 Hz / 0 Hz  
0.3 A (120 V AC) / 0.2 A (230 V AC)  
< 15 A / < 0.1 A<sup>2</sup>s  
> 15 ms (120 V AC) / > 70 ms (230 V AC)

12 V DC ±1%

1.5 A  
Yes / Yes  
< 0.4 W / < 3.2 W  
> 84 % (for 230 V AC and nominal values)  
< 75 mV<sub>PP</sub>

LED

0.11 kg / 36 x 90 x 61 mm  
Alignable: 0 mm horizontally, 30 mm vertically  
Screw connection  
0.2 - 2.5 mm<sup>2</sup> / 0.2 - 2.5 mm<sup>2</sup> / 24 - 12  
IP20 / II (in an enclosed control cabinet)  
> 1800000 h  
-25 °C ... 70 °C (> 55° C derating)

3.75 kV AC (routine test) / 4 kV AC (type test)

Conformance with EMC Directive 2004/108/EC  
IEC 60950-1/VDE 0805 (SELV)  
EN 50178/VDE 0160 (PELV)  
DIN VDE 0100-410, DIN VDE 0106-1010  
UL/C-UL listed UL 508, UL/C-UL Recognized UL 60950,  
NEC Class 2 as per UL 1310, UL ANSI/ISA-12.12.01 Class I,  
Division 2, Groups A, B, C, D (Hazardous Location)

EN 61000-3-2

Ordering data

Type	Order No.	Pcs. / Pkt.
STEP-PS/ 1AC/12DC/1.5	2868567	1

Technical data

100 V AC ... 240 V AC  
85 V AC ... 264 V AC / 95 V DC ... 250 V DC  
45 Hz ... 65 Hz / 0 Hz  
0.6 A (120 V AC) / 0.3 A (230 V AC)  
< 15 A / < 0.6 A<sup>2</sup>s  
> 26 ms (120 V AC) / > 160 ms (230 V AC)

12 V DC ±1%  
10 V DC ... 16.5 V DC (> 12 V constant capacity)

3 A  
Yes / Yes  
< 0.5 W / 6.4 W  
> 85 % (for 230 V AC and nominal values)  
< 40 mV<sub>PP</sub>

LED

0.19 kg / 54 x 90 x 61 mm  
Alignable: 0 mm horizontally, 30 mm vertically  
Screw connection  
0.2 - 2.5 mm<sup>2</sup> / 0.2 - 2.5 mm<sup>2</sup> / 24 - 12  
IP20 / II (in an enclosed control cabinet)  
> 1689000 h  
-25 °C ... 70 °C (> 55° C derating)

3.75 kV AC (routine test) / 4 kV AC (type test)

Conformance with EMC Directive 2004/108/EC  
IEC 60950-1/VDE 0805 (SELV)  
EN 50178/VDE 0160 (PELV)  
DIN VDE 0100-410, DIN VDE 0106-1010  
UL/C-UL listed UL 508, UL/C-UL Recognized UL 60950,  
NEC Class 2 as per UL 1310, UL ANSI/ISA-12.12.01 Class I,  
Division 2, Groups A, B, C, D (Hazardous Location)

EN 61000-3-2

Ordering data

Type	Order No.	Pcs. / Pkt.
STEP-PS/ 1AC/12DC/3	2868570	1

Technical data

100 V AC ... 240 V AC  
85 V AC ... 264 V AC / 95 V DC ... 250 V DC  
45 Hz ... 65 Hz / 0 Hz  
0.8 A (120 V AC) / 0.5 A (230 V AC)  
< 15 A / < 0.6 A<sup>2</sup>s  
> 27 ms (120 V AC) / > 120 ms (230 V AC)

12 V DC ±1%  
10 V DC ... 16.5 V DC (> 12 V constant capacity)

5 A  
Yes / Yes  
< 0.5 W / 8.6 W  
> 87 % (for 230 V AC and nominal values)  
< 55 mV<sub>PP</sub>

LED

0.27 kg / 72 x 90 x 61 mm  
Alignable: 0 mm horizontally, 30 mm vertically  
Screw connection  
0.2 - 2.5 mm<sup>2</sup> / 0.2 - 2.5 mm<sup>2</sup> / 24 - 12  
IP20 / II (in an enclosed control cabinet)  
> 1134000 h  
-25 °C ... 70 °C (> 55° C derating)

3.75 kV AC (routine test) / 4 kV AC (type test)

Conformance with EMC Directive 2004/108/EC  
IEC 60950-1/VDE 0805 (SELV)  
EN 50178/VDE 0160 (PELV)  
DIN VDE 0100-410, DIN VDE 0106-1010  
UL/C-UL listed UL 508, UL/C-UL Recognized UL 60950,  
UL ANSI/ISA-12.12.01 Class I, Division 2, Groups A, B, C, D  
(Hazardous Location)

EN 61000-3-2

Ordering data

Type	Order No.	Pcs. / Pkt.
STEP-PS/ 1AC/12DC/5	2868583	1

# Power supply units and UPS

## Power supply units

### Power supply units for extreme ambient conditions

#### QUINT POWER, dip-coated

With ATEX approval for maximum system availability under extreme ambient conditions, such as dust, dirt, corrosive gases, and 100% humidity

- Complies with standard EN 60079-15 and may be installed in a potentially explosive area.
- They are suitable for use in Class I, Division 2, Groups A, B, C, D



**Power supply, dip-coated, 1 AC, 24 V DC, 5 A**



Ex: Ex, Ex, Ex

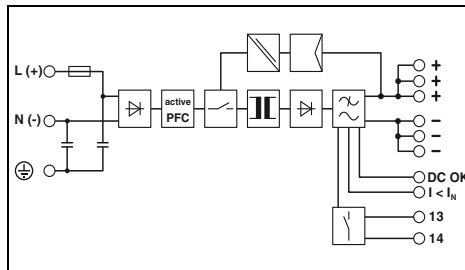

#### Technical data

<b>Input data</b>	
Nominal input voltage range	100 V AC ... 240 V AC
Input voltage range AC/DC	85 V AC ... 264 V AC / 90 V DC ... 430 V DC
Frequency range	45 Hz ... 65 Hz / 0 Hz
Current consumption (nominal load)	1.2 A (120 V AC) / 0.6 A (230 V AC)
Inrush current limitation at 25°C (typ.) / I <sub>t</sub>	< 15 A / < 1 A <sup>2</sup> s
Mains buffering (I <sub>N</sub> , typ.)	> 25 ms (120 V AC) / > 25 ms (230 V AC)
<b>Output data</b>	
Nominal output voltage	24 V DC ±1%
Setting range of the output voltage	18 V DC ... 29.5 V DC (> 24 V constant capacity)
Output current / POWER BOOST / SFB (12 ms)	5 A / 7.5 A / 30 A
Magnetic fuse tripping	B2, B4, C2
Can be connected in parallel / series	Yes / Yes
Max. power dissipation (no load / nominal load)	3 W / 15 W
Efficiency (typ.)	> 90 % (for 230 V AC and nominal values)
Residual ripple	< 40 mV <sub>pp</sub>
<b>Signaling</b>	
Signaling DC OK	LED, active switching output, relay contact
Boost signaling	LED, active switching output
<b>General data</b>	
Weight / Dimensions W x H x D	0.7 kg / 40 x 130 x 125 mm
Spacing when mounting	Alignable: 5 mm horizontally, 15 mm next to active components, 50 mm vertically
<b>Connection method</b>	
Input connection data (solid/stranded/AWG)	Plug-in screw connection
Output connection data (solid/stranded/AWG)	0.2 - 2.5 mm <sup>2</sup> / 0.2 - 2.5 mm <sup>2</sup> / 20 - 12
Signal connection data (solid/stranded/AWG)	0.2 - 2.5 mm <sup>2</sup> / 0.2 - 2.5 mm <sup>2</sup> / 20 - 12
Degree of protection / Protection class	0.2 - 2.5 mm <sup>2</sup> / 0.2 - 2.5 mm <sup>2</sup> / 20 - 12
MTBF (EN 29500, 40°C)	IP20 / I
Ambient temperature (operation)	> 635000 h
	-40 °C ... 70 °C (ATEX/IECEx: -25°C ... +60°C)
<b>Standards/regulations</b>	
Insulation voltage input/output	2 kV AC (routine test) / 4 kV AC (type test)
Electromagnetic compatibility	Conformance with EMC Directive 2004/108/EC
Electrical safety	IEC 60950-1/VDE 0805 (SELV)
Electronic equipm. for electrical power installations	EN 50178/VDE 0160 (PELV)
Safe isolation	DIN VDE 0100-410, DIN VDE 0106-1010
Rail applications	EN 50121-4 / EN 50155
UL approvals	UL/C-UL listed UL 508, UL/C-UL Recognized UL 60950, UL ANSI/ISA-12.12.01 Class I, Division 2, Groups A, B, C, D (Hazardous Location)
	EN 61000-3-2

#### Ordering data

Description	Type	Order No.	Pcs. / Pkt.
Power supply unit, primary-switched	QUINT-PS/ 1AC/24DC/ 5/CO	2320908	1



**Power supply, dip-coated, 1 AC, 24 V DC, 10 A**



Ex: Ex, Ex, Ex

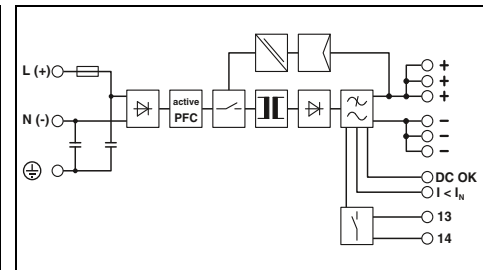

#### Technical data

<b>Input data</b>	
Nominal input voltage range	100 V AC ... 240 V AC
Input voltage range AC/DC	85 V AC ... 264 V AC / 90 V DC ... 430 V DC
Frequency range	45 Hz ... 65 Hz / 0 Hz
Current consumption (nominal load)	2.24 A (120 V AC) / 1.33 A (230 V AC)
Inrush current limitation at 25°C (typ.) / I <sub>t</sub>	< 15 A / < 1.5 A <sup>2</sup> s
Mains buffering (I <sub>N</sub> , typ.)	> 27 ms (120 V AC) / > 31 ms (230 V AC)
<b>Output data</b>	
Nominal output voltage	24 V DC ±1%
Setting range of the output voltage	18 V DC ... 29.5 V DC (> 24 V constant capacity)
Output current / POWER BOOST / SFB (12 ms)	10 A / 15 A / 60 A
Magnetic fuse tripping	B2, B4, B6, C2, C4
Can be connected in parallel / series	Yes / Yes
Max. power dissipation (no load / nominal load)	9.1 W / 22 W
Efficiency (typ.)	> 92.5 % (for 230 V AC and nominal values)
Residual ripple	< 50 mV <sub>pp</sub>
<b>Signaling</b>	
Signaling DC OK	LED, active switching output, relay contact
Boost signaling	LED, active switching output
<b>General data</b>	
Weight / Dimensions W x H x D	1.1 kg / 60 x 130 x 125 mm
Spacing when mounting	Alignable: 5 mm horizontally, 15 mm next to active components, 50 mm vertically
<b>Connection method</b>	
Input connection data (solid/stranded/AWG)	Plug-in screw connection
Output connection data (solid/stranded/AWG)	0.2 - 2.5 mm <sup>2</sup> / 0.2 - 2.5 mm <sup>2</sup> / 16 - 12
Signal connection data (solid/stranded/AWG)	0.2 - 2.5 mm <sup>2</sup> / 0.2 - 2.5 mm <sup>2</sup> / 16 - 12
Degree of protection / Protection class	0.2 - 2.5 mm <sup>2</sup> / 0.2 - 2.5 mm <sup>2</sup> / 16 - 12
MTBF (EN 29500, 40°C)	IP20 / I
Ambient temperature (operation)	> 535000 h
	-40 °C ... 70 °C (ATEX/IECEx: -25°C ... +60°C)
<b>Standards/regulations</b>	
Insulation voltage input/output	2 kV AC (routine test) / 4 kV AC (type test)
Electromagnetic compatibility	Conformance with EMC Directive 2004/108/EC
Electrical safety	IEC 60950-1/VDE 0805 (SELV)
Electronic equipm. for electrical power installations	EN 50178/VDE 0160 (PELV)
Safe isolation	DIN VDE 0100-410, DIN VDE 0106-1010
Rail applications	EN 50121-4 / EN 50155
UL approvals	UL/C-UL listed UL 508, UL/C-UL Recognized UL 60950, UL ANSI/ISA-12.12.01 Class I, Division 2, Groups A, B, C, D (Hazardous Location)
	EN 61000-3-2

#### Ordering data

Description	Type	Order No.	Pcs. / Pkt.
Power supply unit, primary-switched	QUINT-PS/ 1AC/24DC/10/CO	2320911	1



Power supply,  
dip-coated,  
1 AC, 24 V DC, 20 A



Power supply,  
dip-coated,  
3 AC, 24 V DC, 20 A



Power supply  
1 AC, 24 DC, 1.5 A  
DIN rail connector optional

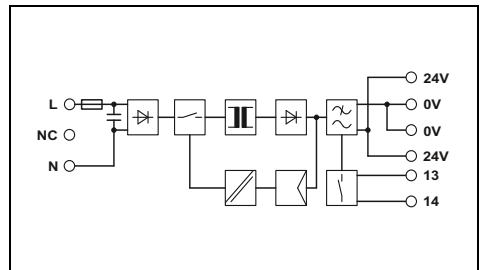
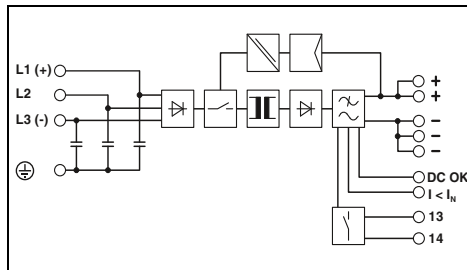
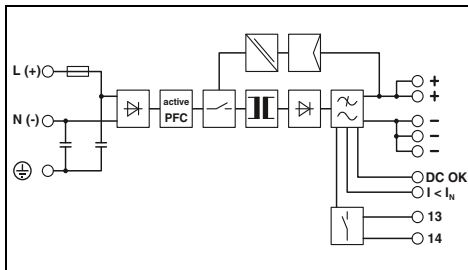

Technical data

Technical data

Technical data

100 V AC ... 240 V AC  
85 V AC ... 264 V AC / 90 V DC ... 350 V DC  
45 Hz ... 65 Hz / 0 Hz  
5.1 A (120 V AC) / 2.3 A (230 V AC)  
< 20 A / < 3.2 A<sup>2</sup>s  
> 20 ms (120 V AC) / > 20 ms (230 V AC)

3x 400 V AC ... 500 V AC  
320 V AC ... 575 V AC / 450 V DC ... 800 V DC  
45 Hz ... 65 Hz / 0 Hz  
3x 1.6 A (400 V AC) / 3x 1.3 A (500 V AC)  
< 20 A / < 3.2 A<sup>2</sup>s  
> 15 ms (400 V AC) / > 25 ms (500 V AC)

100 V AC ... 240 V AC  
85 V AC ... 264 V AC  
45 Hz ... 65 Hz  
0.75 A (120 V AC) / 0.45 A (230 V AC)  
< 15 A / 0.6 A<sup>2</sup>s  
> 20 ms (120 V AC) / > 100 ms (230 V AC)

24 V DC ±1%  
18 V DC ... 29.5 V DC (> 24 V constant capacity)

24 V DC ±1%  
18 V DC ... 29.5 V DC (> 24 V constant capacity)

24 V DC ±1%  
-

20 A / 26 A / 120 A  
B2, B4, B6, B10, B16, C2, C4, C6  
Yes / Yes  
8 W / 40 W  
> 93 % (for 230 V AC and nominal values)  
< 30 mV<sub>PP</sub>

20 A / 26 A / 120 A  
B2, B4, B6, B10, B16, C2, C4, C6  
Yes / Yes  
11 W / 40 W  
> 93 % (at 400 V AC and nominal values)  
< 40 mV<sub>PP</sub>

1.5 A / 2 A  
-  
Yes / Yes  
2.5 W / 12 W  
> 84 % (for 230 V AC and nominal values)  
< 40 mV<sub>PP</sub>

LED, active switching output, relay contact  
LED, active switching output

LED, active switching output, relay contact  
LED, active switching output

LED, relay contact  
-

1.7 kg / 90 x 130 x 125 mm  
Alignable: 5 mm horizontally, 15 mm next to active components, 50 mm vertically  
Screw connection  
0.2 - 6 mm<sup>2</sup> / 0.2 - 4 mm<sup>2</sup> / 18 - 10  
0.2 - 6 mm<sup>2</sup> / 0.2 - 4 mm<sup>2</sup> / 12 - 10  
0.2 - 6 mm<sup>2</sup> / 0.2 - 4 mm<sup>2</sup> / 18 - 10  
IP20 / I  
> 520000 h  
-25 °C ... 70 °C (> 60 °C derating)

1.5 kg / 69 x 130 x 125 mm  
Alignable: 5 mm horizontally, 15 mm next to active components, 50 mm vertically  
Screw connection  
0.2 - 6 mm<sup>2</sup> / 0.2 - 4 mm<sup>2</sup> / 18 - 10  
0.2 - 6 mm<sup>2</sup> / 0.2 - 4 mm<sup>2</sup> / 12 - 10  
0.2 - 6 mm<sup>2</sup> / 0.2 - 4 mm<sup>2</sup> / 18 - 10  
IP20 / I  
> 534000 h  
-40 °C ... 70 °C (> 60 °C derating)

0.25 kg / 35 x 99 x 95 mm  
Can be aligned: Horizontally 0 mm, vertically 50 mm  
Plug-in screw connection  
0.2 - 2.5 mm<sup>2</sup> / 0.2 - 2.5 mm<sup>2</sup> / 24 - 12  
0.2 - 2.5 mm<sup>2</sup> / 0.2 - 2.5 mm<sup>2</sup> / 24 - 12  
0.5 - 16 mm<sup>2</sup> / 0.5 - 10 mm<sup>2</sup> / 20 - 6  
IP20 / II (in an enclosed control cabinet)  
> 2789000 h  
-25 °C ... 70 °C (> 60 °C derating)

2 kV AC (routine test) / 4 kV AC (type test)  
Conformance with EMC Directive 2004/108/EC  
IEC 60950-1/VDE 0805 (SELV)  
EN 50178/VDE 0160 (PELV)  
DIN VDE 0100-410, DIN VDE 0106-1010  
EN 50121-4 / EN 50155  
UL/C-UL listed UL 508, UL/C-UL Recognized UL 60950,  
UL ANSI/ISA-12.12.01 Class I, Division 2, Groups A, B, C, D  
(Hazardous Location)  
EN 61000-3-2

2 kV AC (routine test) / 4 kV AC (type test)  
Conformance with EMC Directive 2004/108/EC  
IEC 60950-1/VDE 0805 (SELV)  
EN 50178/VDE 0160 (PELV)  
DIN VDE 0100-410, DIN VDE 0106-1010  
EN 50121-4 / EN 50155  
UL/C-UL listed UL 508, UL/C-UL Recognized UL 60950,  
UL ANSI/ISA-12.12.01 Class I, Division 2, Groups A, B, C, D  
(Hazardous Location)  
EN 61000-3-2

3 kV AC (routine test) / 4 kV AC (type test)  
Conformance with EMC Directive 2004/108/EC  
EN 60950-1/VDE 0805 (SELV)  
EN 50178/VDE 0160 (PELV)  
DIN VDE 0100-410, DIN VDE 0106-1010  
-  
UL/C-UL listed UL 508, UL/C-UL Recognized UL 60950  
EN 61000-3-2

Ordering data

Ordering data

Ordering data

Type	Order No.	Pcs. / Pkt.
QUINT-PS/ 1AC/24DC/20/CO	2320898	1

Type	Order No.	Pcs. / Pkt.
QUINT-PS/ 3AC/24DC/20/CO	2320924	1

Type	Order No.	Pcs. / Pkt.
MINI-PS-100-240AC/24DC/1.5/EX	2866653	1



**QUINT and MINI DC/DC converters alter the voltage level, regenerate the voltage at the end of long cables, or enable the creation of independent supply systems by means of electrical isolation.**

There are numerous fields of application for DC/DC converters. As the name suggests, they convert voltages in order to match different voltage levels to one another. On long supply lines, they raise the voltage to compensate for voltage drops.

DC/DC converters separate circuits from each other using electrical isolation and protect the sensitive loads by decoupling them. The primary-switched switching devices have an internal intermediate circuit. This acts as a filter. This means, for example, that grounded and ungrounded circuits can be kept separate. A further advantage is the protection of critical loads from damaging voltage fluctuations: if, for example, a motor is switched on that requires a higher current for the starting torque, there is a short voltage dip. The same occurs when loads with high input capacities are switched on. Troubleshooting these temporary faults is often difficult and time-consuming.

DC/DC converters are also ideal in battery-supported power supply networks or

solutions with unregulated transformers, when sensitive loads require a stable DC.

### **QUINT POWER for maximum system availability**

Cost-effective selective fuse protection with SFB technology:

In order to trip standard circuit breakers magnetically and quickly, power supply units must be able to supply several times the nominal current for a short period. With SFB (Selective Fuse Breaking) technology, which supplies up to 6 times the nominal current for 12 ms, a dynamic power reserve is available. Faulty current paths are selectively switched off, the fault is isolated, and important system components remain operational.

#### Preventive function monitoring:

Comprehensive diagnostics are provided through constant monitoring of the output voltage and current. This constant, preventive monitoring of input voltage, output voltage, and output current visualizes critical operating states before errors can occur. Remote monitoring is provided by means of active switching outputs and floating relay contacts.

#### POWER BOOST power reserve:

The static power reserve offers up to 1.25 times the nominal current permanently. At ambient temperatures of up to +40°C the POWER BOOST is continuously available and at higher temperatures, it is available for a few minutes. This ensures that both high inrush currents of capacitive loads, as well as loads with DC/DC converters in the primary circuit, can be reliably supplied.



**For maximum system availability**

The unique SFB technology and preventive function monitoring maximize the availability of your application.

- Quick tripping of the standard power circuit breakers
- Preventive function monitoring
- Reliable starting of heavy loads

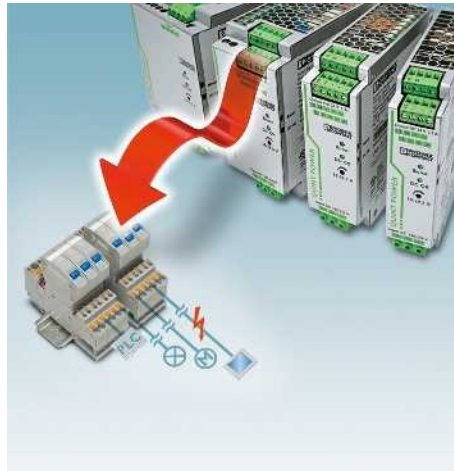

**Maximum system availability with SFB technology**

SFB technology using a frayed display cable as an example:

- The fuse triggers immediately, the lower lever display is dark.
- The controller, sensors, and actuators continue to operate without interruption.
- Production continues.



**MINI DC/DC converter - for control technology**

MINI DC/DC converters come into their own in fields where modular electronics housing has become the standard.

- Service-friendly connection technology with COMBICON encoded plug-in connectors
- Active function monitoring with switching output for remote monitoring of the output voltage

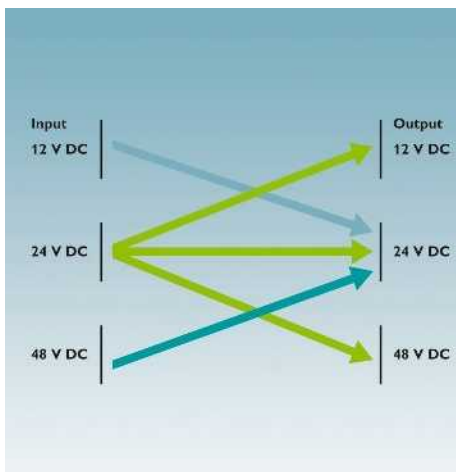

**Voltage levels of QUINT DC/DC converters**

The QUINT DC/DC converters alter the voltage level:

- Input voltages: 12 V DC, 24 V DC, 48 V DC
- Output voltages: 12 V DC, 24 V DC, 48 V DC

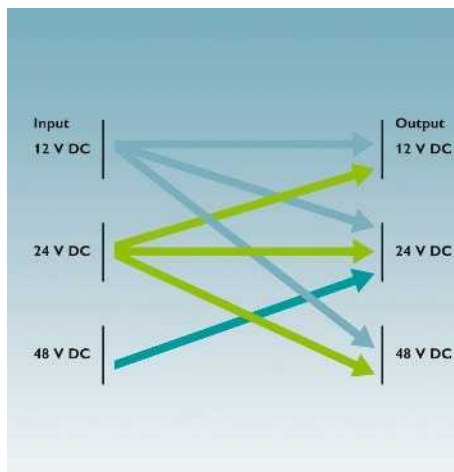

**Voltage levels of MINI DC/DC converters**

The MINI DC/DC converters alter the voltage level:

- Input voltages: 12 V DC, 24 V DC, 48 V DC
- Output voltages: 5...15 V DC, 24 V DC, 48 V DC



**TRIO for frequency inverters**

- Direct connection to the 600 V DC intermediate circuit of a frequency inverter
- Mains failure: 24 V loads continue to be supplied using the kinetic energy of the motor. In this case, the motors act as generators and supply energy to the intermediate circuit.

Details about this product can be found on page 178

# Power supply units and UPS

## DC/DC converters

### QUINT DC/DC converters, 24 V DC

- Support conversion to various voltage levels
- Constant voltage: output voltage regenerated even at the end of long cables
- Electrical isolation: for setting up independent supply systems
- SFB technology: fast tripping of standard circuit breakers, thanks to the dynamic power reserve with up to 6 times the nominal current for 12 ms
- Reliable starting of heavy loads thanks to the static POWER BOOST power reserve with permanently up to 125% of the nominal current
- Preventive function monitoring warns against critical operating states before errors occur



DC/DC converter,  
24 V DC / 24 V DC, 5 A

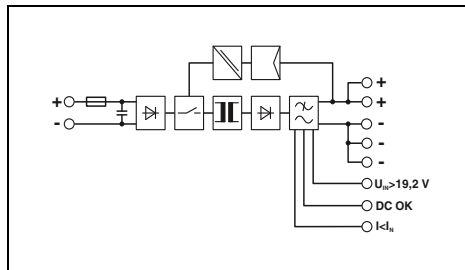

#### Technical data

<b>Input data</b>	
Nominal input voltage	24 V DC
DC input voltage range	18 V DC ... 32 V DC
Current consumption (POWER BOOST)	7 A (24 V DC)
Inrush current limitation at 25°C (typ.) / I <sub>rt</sub>	< 15 A / < 0.5 A <sup>2</sup> s
Mains buffering (I <sub>N</sub> , typ.)	> 10 ms (24 V DC)
<b>Output data</b>	
Nominal output voltage	24 V DC ±1%
Setting range of the output voltage	18 V DC ... 29.5 V DC (> 24 V constant capacity)
<b>Output current / POWER BOOST / SFB (12 ms)</b>	5 A / 6.25 A / 30 A
Magnetic fuse tripping	B2, B4, C2
Can be connected in parallel / series	Yes / Yes
Max. power dissipation (no load / nominal load)	2.4 W / 11.4 W
Efficiency (typ.)	> 92 %
Residual ripple	< 20 mV <sub>pp</sub>
<b>Signaling</b>	
Signaling DC OK	LED, active switching output
Boost signaling	LED, active switching output
U <sub>N</sub> signaling	LED, active switching output
<b>General data</b>	
Weight / Dimensions W x H x D	0.7 kg / 32 x 130 x 125 mm
Spacing when mounting	Alignable: 5 mm horizontally, 15 mm next to active components, 50 mm vertically
<b>Connection method</b>	Plug-in screw connection
Input connection data (solid/stranded/AWG)	0.2 - 2.5 mm <sup>2</sup> / 0.2 - 2.5 mm <sup>2</sup> / 24 - 12
Output connection data (solid/stranded/AWG)	0.2 - 2.5 mm <sup>2</sup> / 0.2 - 2.5 mm <sup>2</sup> / 24 - 12
Signal connection data (solid/stranded/AWG)	0.2 - 2.5 mm <sup>2</sup> / 0.2 - 2.5 mm <sup>2</sup> / 24 - 12
Degree of protection / Protection class	IP20 / III
MTBF (EN 29500, 40°C)	> 890000 h
Ambient temperature (operation)	-25 °C ... 70 °C (> 60 °C derating)
Max. permissible relative humidity (operation)	≤ 95 % (at 25 °C, no condensation)
<b>Standards/regulations</b>	
Insulation voltage input/output	1 kV (routine test) / 1.5 kV (type test)
Electromagnetic compatibility	Conformance with EMC Directive 2004/108/EC
Electrical safety	EN 60950-1/VDE 0805 (SELV)
Electronic equipm. for electrical power installations	EN 50178/VDE 0160 (PELV)
Safe isolation	DIN VDE 0100-410
UL approvals	UL/C-UL listed UL 508, UL/C-UL Recognized UL 60950, UL ANSI/ISA-12.12.01 Class I, Division 2, Groups A, B, C, D (Hazardous Location)



DC/DC converter,  
24 V DC / 24 V DC, 10 A

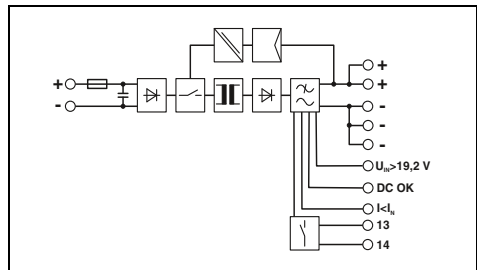

#### Technical data

<b>Input data</b>	
Nominal input voltage	24 V DC
DC input voltage range	18 V DC ... 32 V DC
Current consumption (POWER BOOST)	14 A (24 V DC)
Inrush current limitation at 25°C (typ.) / I <sub>rt</sub>	< 15 A / < 2.7 A <sup>2</sup> s
Mains buffering (I <sub>N</sub> , typ.)	> 12 ms (24 V DC)
<b>Output data</b>	
Nominal output voltage	24 V DC ±1%
Setting range of the output voltage	18 V DC ... 29.5 V DC (> 24 V constant capacity)
<b>Output current / POWER BOOST / SFB (12 ms)</b>	10 A / 12.5 A / 60 A
Magnetic fuse tripping	B2, B4, B6, C2, C4
Can be connected in parallel / series	Yes / Yes
Max. power dissipation (no load / nominal load)	1.6 W / 24 W
Efficiency (typ.)	> 92 %
Residual ripple	< 20 mV <sub>pp</sub>
<b>Signaling</b>	
Signaling DC OK	LED, active switching output, relay contact
Boost signaling	LED, active switching output
U <sub>N</sub> signaling	LED, active switching output
<b>General data</b>	
Weight / Dimensions W x H x D	0.9 kg / 48 x 130 x 125 mm
Spacing when mounting	Alignable: 5 mm horizontally, 15 mm next to active components, 50 mm vertically
<b>Connection method</b>	Plug-in screw connection
Input connection data (solid/stranded/AWG)	0.2 - 2.5 mm <sup>2</sup> / 0.2 - 2.5 mm <sup>2</sup> / 24 - 12
Output connection data (solid/stranded/AWG)	0.2 - 2.5 mm <sup>2</sup> / 0.2 - 2.5 mm <sup>2</sup> / 24 - 12
Signal connection data (solid/stranded/AWG)	0.2 - 2.5 mm <sup>2</sup> / 0.2 - 2.5 mm <sup>2</sup> / 24 - 12
Degree of protection / Protection class	IP20 / III
MTBF (EN 29500, 40°C)	> 763000 h
Ambient temperature (operation)	-25 °C ... 70 °C (> 60 °C derating)
Max. permissible relative humidity (operation)	≤ 95 % (at 25 °C, no condensation)
<b>Standards/regulations</b>	
Insulation voltage input/output	1 kV (routine test) / 1.5 kV (type test)
Electromagnetic compatibility	Conformance with EMC Directive 2004/108/EC
Electrical safety	EN 60950-1/VDE 0805 (SELV)
Electronic equipm. for electrical power installations	EN 50178/VDE 0160 (PELV)
Safe isolation	DIN VDE 0100-410
UL approvals	UL/C-UL listed UL 508, UL/C-UL Recognized UL 60950, UL ANSI/ISA-12.12.01 Class I, Division 2, Groups A, B, C, D (Hazardous Location)

#### Ordering data

<b>Description</b>	
DC/DC converter, primary switched mode	

Type	Order No.	Pcs. / Pkt.
QUINT-PS/24DC/24DC/ 5	2320034	1

#### Ordering data

Type	Order No.	Pcs. / Pkt.
QUINT-PS/24DC/24DC/10	2320092	1





DC/DC converter,  
24 V DC / 24 V DC, 20 A



DC/DC converter,  
24 V DC / 12 V DC, 8 A

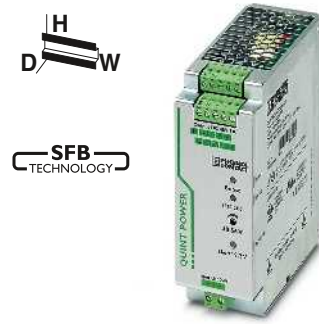

DC/DC converter,  
24 V DC / 48 V DC, 5 A

UL CE CB  
Ex: U

UL CE ABS BL ClassNK CB  
Ex: U

UL CE ABS BL ClassNK CB  
Ex: U

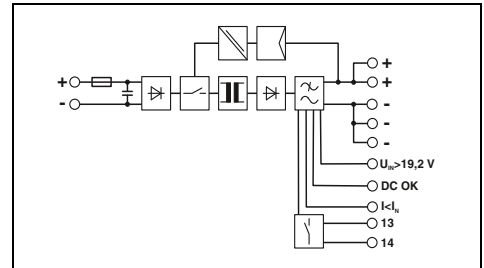
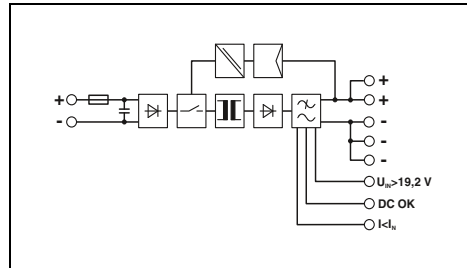
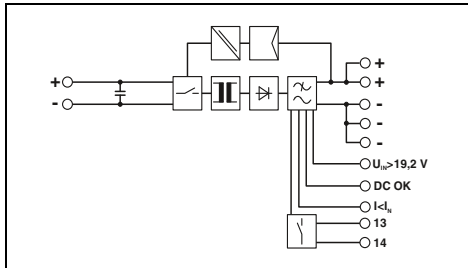

Technical data

Technical data

Technical data

24 V DC  
18 V DC ... 32 V DC  
28 A (24 V DC)  
< 26 A / < 11 A<sup>2</sup>s  
> 10 ms (24 V DC)

24 V DC  
18 V DC ... 32 V DC  
6 A (24 V DC)  
< 15 A / < 0.5 A<sup>2</sup>s  
> 10 ms (24 V DC)

24 V DC  
18 V DC ... 32 V DC  
14 A (24 V DC)  
< 15 A / 3 A<sup>2</sup>s  
> 12 ms (24 V DC)

24 V DC ±1%  
18 V DC ... 29.5 V DC (> 24 V constant capacity)

12 V DC ±1%  
5 V DC ... 18 V DC (> 12 V constant capacity)

48 V DC ±1%  
30 V DC ... 56 V DC (> 48 V constant capacity)

20 A / 25 A / 120 A  
B2, B4, B6, B10, B16, C2, C4, C6  
Yes / Yes  
2.2 W / 39 W  
> 93 %  
< 20 mV<sub>pp</sub>

8 A / 10 A / 48 A  
B2, B4, C2  
Yes / Yes  
2 W / 10.5 W  
> 90 %  
< 20 mV<sub>pp</sub>

5 A / 6.25 A / 30 A  
B2, B4, C2  
Yes / Yes  
5.2 W / 21 W  
> 92.5 %  
< 20 mV<sub>pp</sub>

LED, active switching output, relay contact  
LED, active switching output  
LED, active switching output

LED, active switching output  
LED, active switching output  
LED, active switching output

LED, active switching output, relay contact  
LED, active switching output  
LED, active switching output

1.7 kg / 82 x 130 x 125 mm  
Alignable: 5 mm horizontally, 15 mm next to active components, 50 mm vertically  
Screw connection  
0.5 - 16 mm<sup>2</sup> / 0.5 - 16 mm<sup>2</sup> / 8 - 6  
0.2 - 6 mm<sup>2</sup> / 0.2 - 4 mm<sup>2</sup> / 12 - 10  
0.2 - 2.5 mm<sup>2</sup> / 0.2 - 2.5 mm<sup>2</sup> / 24 - 12  
IP20 / III  
> 554000 h  
-25 °C ... 70 °C (> 60 °C derating)  
≤ 95 % (at 25 °C, no condensation)

0.7 kg / 32 x 130 x 125 mm  
Alignable: 5 mm horizontally, 15 mm next to active components, 50 mm vertically  
Plug-in screw connection  
0.2 - 2.5 mm<sup>2</sup> / 0.2 - 2.5 mm<sup>2</sup> / 24 - 12  
0.2 - 2.5 mm<sup>2</sup> / 0.2 - 2.5 mm<sup>2</sup> / 24 - 12  
0.2 - 2.5 mm<sup>2</sup> / 0.2 - 2.5 mm<sup>2</sup> / 24 - 12  
IP20 / III  
> 843000 h  
-25 °C ... 70 °C (> 60 °C derating)  
≤ 95 % (at 25 °C, no condensation)

0.9 kg / 48 x 130 x 125 mm  
Alignable: 5 mm horizontally, 15 mm next to active components, 50 mm vertically  
Plug-in screw connection  
0.2 - 2.5 mm<sup>2</sup> / 0.2 - 2.5 mm<sup>2</sup> / 24 - 12  
0.2 - 2.5 mm<sup>2</sup> / 0.2 - 2.5 mm<sup>2</sup> / 24 - 12  
0.2 - 2.5 mm<sup>2</sup> / 0.2 - 2.5 mm<sup>2</sup> / 24 - 12  
IP20 / III  
> 461000 h  
-25 °C ... 70 °C (> 60 °C derating)  
≤ 95 % (at 25 °C, no condensation)

1 kV (routine test) / 1.5 kV (type test)  
Conformance with EMC Directive 2004/108/EC  
EN 60950-1/VDE 0805 (SELV)  
EN 50178/VDE 0160 (PELV)  
DIN VDE 0100-410  
UL/C-UL listed UL 508, UL/C-UL Recognized UL 60950,  
UL ANSI/ISA-12.12.01 Class I, Division 2, Groups A, B, C, D  
(Hazardous Location)

1 kV (routine test) / 1.5 kV (type test)  
Conformance with EMC Directive 2004/108/EC  
EN 60950-1/VDE 0805 (SELV)  
EN 50178/VDE 0160 (PELV)  
DIN VDE 0100-410  
UL/C-UL listed UL 508, UL/C-UL Recognized UL 60950,  
UL ANSI/ISA-12.12.01 Class I, Division 2, Groups A, B, C, D  
(Hazardous Location)

1 kV (routine test) / 1.5 kV (type test)  
Conformance with EMC Directive 2004/108/EC  
EN 60950-1/VDE 0805 (SELV)  
EN 50178/VDE 0160 (PELV)  
DIN VDE 0100-410  
UL/C-UL listed UL 508, UL/C-UL Recognized UL 60950,  
UL ANSI/ISA-12.12.01 Class I, Division 2, Groups A, B, C, D  
(Hazardous Location)

Ordering data

Ordering data

Ordering data

Type	Order No.	Pcs. / Pkt.
QUINT-PS/24DC/24DC/20	2320102	1

Type	Order No.	Pcs. / Pkt.
QUINT-PS/24DC/12DC/ 8	2320115	1

Type	Order No.	Pcs. / Pkt.
QUINT-PS/24DC/48DC/ 5	2320128	1

# Power supply units and UPS

## DC/DC converters

### QUINT DC/DC converters

#### QUINT DC/DC converter, 12 and 48 V DC

- SFB technology: quick tripping of standard circuit breakers
- Reliably start difficult loads, thanks to the static POWER BOOST power reserve
- Preventive function monitoring



DC/DC converter,  
12 V DC / 24 V DC, 5 A



DC/DC converter,  
48 V DC / 24 V DC, 5 A

#### QUINT DC/DC converter, 24 V DC, dip-coated

- For maximum system availability under extreme ambient conditions, such as dust, dirt, corrosive gases, and 100% humidity
- They are suitable for use in Class I, Division 2, Groups A, B, C, D

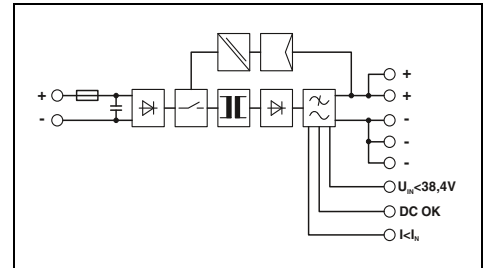
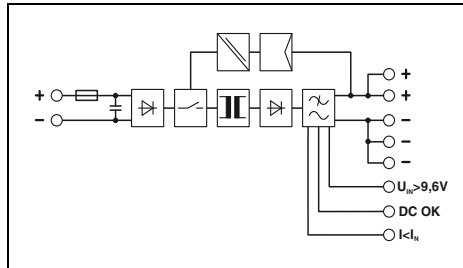

#### Technical data

<b>Input data</b>	
Nominal input voltage	12 V DC
DC input voltage range	9 V DC ... 18 V DC
Current consumption (POWER BOOST)	15 A (12 V DC)
Inrush current limitation at 25°C (typ.) / I <sup>2</sup> t	< 12 A / < 0.3 A <sup>2</sup> s
Mains buffering (I <sub>N</sub> , typ.)	> 3 ms (12 V DC)
<b>Output data</b>	
Nominal output voltage	24 V DC ±1%
Setting range of the output voltage	18 V DC ... 29.5 V DC (> 24 V constant capacity)
<b>Output current / POWER BOOST / SFB (12 ms)</b>	
Magnetic fuse tripping	5 A / 6.25 A / 30 A
Can be connected in parallel / series	B2, B4, C2
Max. power dissipation (no load / nominal load)	Yes / Yes
Efficiency (typ.)	2 W / 13.5 W
Residual ripple	> 90 %
<b>Signaling</b>	
Signaling DC OK	< 75 mV <sub>pp</sub>
Boost signaling	LED, active switching output
U <sub>N</sub> signaling	LED, active switching output
<b>General data</b>	
Weight / Dimensions W x H x D	0.7 kg / 32 x 130 x 125 mm
Spacing when mounting	Alignable: 5 mm horizontally, 15 mm next to active components, 50 mm vertically
<b>Connection method</b>	
Input connection data (solid/stranded/AWG)	Plug-in screw connection
Output connection data (solid/stranded/AWG)	0.2 - 2.5 mm <sup>2</sup> / 0.2 - 2.5 mm <sup>2</sup> / 18 - 12
Signal connection data (solid/stranded/AWG)	0.2 - 2.5 mm <sup>2</sup> / 0.2 - 2.5 mm <sup>2</sup> / 18 - 12
Degree of protection / Protection class	0.2 - 2.5 mm <sup>2</sup> / 0.2 - 2.5 mm <sup>2</sup> / 18 - 12
MTBF (EN 29500, 40°C)	IP20 / III
Ambient temperature (operation)	> 1005000 h
Max. permissible relative humidity (operation)	-25 °C ... 70 °C (> 60 °C derating)
<b>Standards/regulations</b>	
Insulation voltage input/output	1 kV (routine test) / 1.5 kV (type test)
Electromagnetic compatibility	Conformance with EMC Directive 2004/108/EC
Electrical safety	EN 60950-1/VDE 0805 (SELV)
Electronic equipm. for electrical power installations	EN 50178/VDE 0160 (PELV)
Safe isolation	DIN VDE 0100-410
Rail applications	-
UL approvals	UL/C-UL listed UL 508, UL/C-UL Recognized UL 60950, UL ANSI/ISA-12.12.01 Class I, Division 2, Groups A, B, C, D (Hazardous Location)

<b>Technical data</b>	
Nominal input voltage	48 V DC
DC input voltage range	30 V DC ... 60 V DC
Current consumption (POWER BOOST)	3.5 A (48 V DC)
Inrush current limitation at 25°C (typ.) / I <sup>2</sup> t	< 5 A / < 0.2 A <sup>2</sup> s
Mains buffering (I <sub>N</sub> , typ.)	> 14 ms (48 V DC)
<b>Output data</b>	
Nominal output voltage	24 V DC ±1%
Setting range of the output voltage	18 V DC ... 29.5 V DC (> 24 V constant capacity)
<b>Output current / POWER BOOST / SFB (12 ms)</b>	
Magnetic fuse tripping	5 A / 6.25 A / 30 A
Can be connected in parallel / series	B2, B4, C2
Max. power dissipation (no load / nominal load)	Yes / Yes
Efficiency (typ.)	2.7 W / 11 W
Residual ripple	> 91.5 %
<b>Signaling</b>	
Signaling DC OK	< 25 mV <sub>pp</sub>
Boost signaling	LED, active switching output
U <sub>N</sub> signaling	LED, active switching output
<b>General data</b>	
Weight / Dimensions W x H x D	0.7 kg / 32 x 130 x 125 mm
Spacing when mounting	Alignable: 5 mm horizontally, 15 mm next to active components, 50 mm vertically
<b>Connection method</b>	
Input connection data (solid/stranded/AWG)	Plug-in screw connection
Output connection data (solid/stranded/AWG)	0.2 - 2.5 mm <sup>2</sup> / 0.2 - 2.5 mm <sup>2</sup> / 18 - 12
Signal connection data (solid/stranded/AWG)	0.2 - 2.5 mm <sup>2</sup> / 0.2 - 2.5 mm <sup>2</sup> / 18 - 12
Degree of protection / Protection class	0.2 - 2.5 mm <sup>2</sup> / 0.2 - 2.5 mm <sup>2</sup> / 18 - 12
MTBF (EN 29500, 40°C)	IP20 / III
Ambient temperature (operation)	> 995000 h
Max. permissible relative humidity (operation)	-25 °C ... 70 °C (> 60 °C derating)
<b>Standards/regulations</b>	
Insulation voltage input/output	1 kV (routine test) / 1.5 kV (type test)
Electromagnetic compatibility	Conformance with EMC Directive 2004/108/EC
Electrical safety	EN 60950-1/VDE 0805 (SELV)
Electronic equipm. for electrical power installations	EN 50178/VDE 0160 (PELV)
Safe isolation	DIN VDE 0100-410
Rail applications	-
UL approvals	UL/C-UL listed UL 508, UL/C-UL Recognized UL 60950, UL ANSI/ISA-12.12.01 Class I, Division 2, Groups A, B, C, D (Hazardous Location)

<b>Technical data</b>	
Nominal input voltage	48 V DC
DC input voltage range	30 V DC ... 60 V DC
Current consumption (POWER BOOST)	3.5 A (48 V DC)
Inrush current limitation at 25°C (typ.) / I <sup>2</sup> t	< 5 A / < 0.2 A <sup>2</sup> s
Mains buffering (I <sub>N</sub> , typ.)	> 14 ms (48 V DC)
<b>Output data</b>	
Nominal output voltage	24 V DC ±1%
Setting range of the output voltage	18 V DC ... 29.5 V DC (> 24 V constant capacity)
<b>Output current / POWER BOOST / SFB (12 ms)</b>	
Magnetic fuse tripping	5 A / 6.25 A / 30 A
Can be connected in parallel / series	B2, B4, C2
Max. power dissipation (no load / nominal load)	Yes / Yes
Efficiency (typ.)	2.7 W / 11 W
Residual ripple	> 91.5 %
<b>Signaling</b>	
Signaling DC OK	< 25 mV <sub>pp</sub>
Boost signaling	LED, active switching output
U <sub>N</sub> signaling	LED, active switching output
<b>General data</b>	
Weight / Dimensions W x H x D	0.7 kg / 32 x 130 x 125 mm
Spacing when mounting	Alignable: 5 mm horizontally, 15 mm next to active components, 50 mm vertically
<b>Connection method</b>	
Input connection data (solid/stranded/AWG)	Plug-in screw connection
Output connection data (solid/stranded/AWG)	0.2 - 2.5 mm <sup>2</sup> / 0.2 - 2.5 mm <sup>2</sup> / 18 - 12
Signal connection data (solid/stranded/AWG)	0.2 - 2.5 mm <sup>2</sup> / 0.2 - 2.5 mm <sup>2</sup> / 18 - 12
Degree of protection / Protection class	0.2 - 2.5 mm <sup>2</sup> / 0.2 - 2.5 mm <sup>2</sup> / 18 - 12
MTBF (EN 29500, 40°C)	IP20 / III
Ambient temperature (operation)	> 995000 h
Max. permissible relative humidity (operation)	-25 °C ... 70 °C (> 60 °C derating)
<b>Standards/regulations</b>	
Insulation voltage input/output	1 kV (routine test) / 1.5 kV (type test)
Electromagnetic compatibility	Conformance with EMC Directive 2004/108/EC
Electrical safety	EN 60950-1/VDE 0805 (SELV)
Electronic equipm. for electrical power installations	EN 50178/VDE 0160 (PELV)
Safe isolation	DIN VDE 0100-410
Rail applications	-
UL approvals	UL/C-UL listed UL 508, UL/C-UL Recognized UL 60950, UL ANSI/ISA-12.12.01 Class I, Division 2, Groups A, B, C, D (Hazardous Location)

#### Ordering data

Description	Type	Order No.	Pcs. / Pkt.
DC/DC converter, primary switched mode	QUINT-PS/12DC/24DC/5	2320131	1

Description	Type	Order No.	Pcs. / Pkt.
DC/DC converter, primary switched mode	QUINT-PS/12DC/24DC/5	2320131	1

#### Ordering data

Description	Type	Order No.	Pcs. / Pkt.
DC/DC converter, primary switched mode	QUINT-PS/48DC/24DC/5	2320144	1

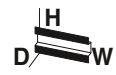

DC/DC converter,  
dip-coated,  
24 V DC/24 V DC, 5 A

DC/DC converter,  
dip-coated,  
24 V DC/24 V DC, 10 A

DC/DC converter,  
dip-coated,  
24 V DC/24 V DC, 20 A

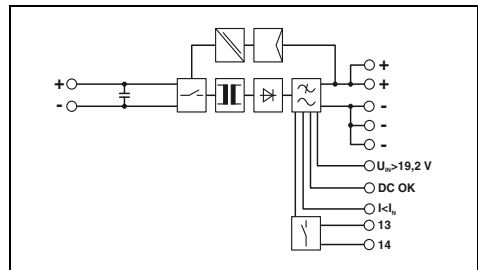
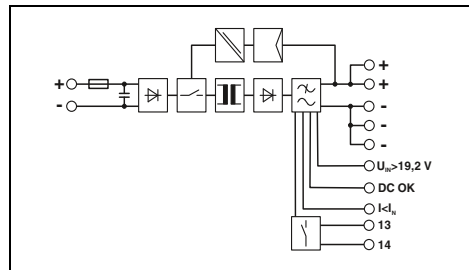
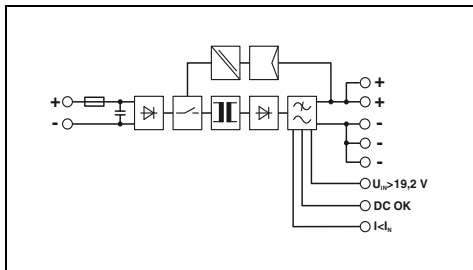

Technical data

Technical data

Technical data

24 V DC  
18 V DC ... 32 V DC  
7 A (24 V DC)  
< 15 A / < 0.5 A<sup>2</sup>s  
> 10 ms (24 V DC)

24 V DC ±1%  
18 V DC ... 29.5 V DC (> 24 V constant capacity)

5 A / 6.25 A / 30 A  
B2, B4, C2  
Yes / Yes  
2.4 W / 11.4 W  
> 92 %  
< 20 mV<sub>PP</sub>

LED, active switching output  
LED, active switching output  
LED, active switching output

0.7 kg / 32 x 130 x 125 mm  
Alignable: 5 mm horizontally, 15 mm next to active components, 50 mm vertically  
Plug-in screw connection  
0.2 - 2.5 mm<sup>2</sup> / 0.2 - 2.5 mm<sup>2</sup> / 24 - 12  
0.2 - 2.5 mm<sup>2</sup> / 0.2 - 2.5 mm<sup>2</sup> / 24 - 12  
0.2 - 2.5 mm<sup>2</sup> / 0.2 - 2.5 mm<sup>2</sup> / 24 - 12  
IP20 / III  
> 890000 h  
-25 °C ... 70 °C (> 60 °C derating)  
100 % (at 25 °C, no condensation)

1 kV (routine test) / 1.5 kV (type test)  
Conformance with EMC Directive 2004/108/EC  
EN 60950-1/VDE 0805 (SELV)  
EN 50178/VDE 0160 (PELV)  
DIN VDE 0100-410  
EN 50121-4 / EN 50155  
UL applied for

24 V DC  
18 V DC ... 32 V DC  
14 A (24 V DC)  
< 15 A / < 2.7 A<sup>2</sup>s  
> 12 ms (24 V DC)

24 V DC ±1%  
18 V DC ... 29.5 V DC (> 24 V constant capacity)

10 A / 12.5 A / 60 A  
B2, B4, B6, C2, C4  
Yes / Yes  
1.6 W / 24 W  
> 92 %  
< 20 mV<sub>PP</sub>

LED, active switching output, relay contact  
LED, active switching output  
LED, active switching output

0.9 kg / 60 x 130 x 125 mm  
Alignable: 5 mm horizontally, 15 mm next to active components, 50 mm vertically  
Plug-in screw connection  
0.2 - 2.5 mm<sup>2</sup> / 0.2 - 2.5 mm<sup>2</sup> / 24 - 12  
0.2 - 2.5 mm<sup>2</sup> / 0.2 - 2.5 mm<sup>2</sup> / 24 - 12  
0.2 - 2.5 mm<sup>2</sup> / 0.2 - 2.5 mm<sup>2</sup> / 24 - 12  
IP20 / III  
> 763000 h  
-25 °C ... 70 °C (> 60 °C derating)  
100 % (at 25 °C, no condensation)

1 kV (routine test) / 1.5 kV (type test)  
Conformance with EMC Directive 2004/108/EC  
EN 60950-1/VDE 0805 (SELV)  
EN 50178/VDE 0160 (PELV)  
DIN VDE 0100-410  
EN 50121-4 / EN 50155  
UL applied for

24 V DC  
18 V DC ... 32 V DC  
28 A (24 V DC)  
< 26 A / < 11 A<sup>2</sup>s  
> 10 ms (24 V DC)

24 V DC ±1%  
18 V DC ... 29.5 V DC (> 24 V constant capacity)

20 A / 25 A / 120 A  
B2, B4, B6, B10, B16, C2, C4, C6  
Yes / Yes  
2.2 W / 39 W  
> 93 %  
< 20 mV<sub>PP</sub>

LED, active switching output, relay contact  
LED, active switching output  
LED, active switching output

1.7 kg / 82 x 130 x 125 mm  
Alignable: 5 mm horizontally, 15 mm next to active components, 50 mm vertically  
Screw connection  
0.5 - 16 mm<sup>2</sup> / 0.5 - 16 mm<sup>2</sup> / 8 - 6  
0.2 - 6 mm<sup>2</sup> / 0.2 - 4 mm<sup>2</sup> / 12 - 10  
0.2 - 2.5 mm<sup>2</sup> / 0.2 - 2.5 mm<sup>2</sup> / 24 - 12  
IP20 / III  
> 554000 h  
-25 °C ... 70 °C (> 60 °C derating)  
100 % (at 25 °C, no condensation)

1 kV (routine test) / 1.5 kV (type test)  
Conformance with EMC Directive 2004/108/EC  
EN 60950-1/VDE 0805 (SELV)  
EN 50178/VDE 0160 (PELV)  
DIN VDE 0100-410  
EN 50121-4 / EN 50155  
UL applied for

Ordering data

Ordering data

Ordering data

Type	Order No.	Pcs. / Pkt.
QUINT-PS/24DC/24DC/5/CO	2320542	1

Type	Order No.	Pcs. / Pkt.
QUINT-PS/24DC/24DC/10/CO	2320555	1

Type	Order No.	Pcs. / Pkt.
QUINT-PS/24DC/24DC/20/CO	2320568	1

# Power supply units and UPS

## DC/DC converters

### MINI DC/DC converters

- Support conversion to various voltage levels
- Constant voltage: output voltage regenerated even at the end of long cables
- Electrical isolation: for setting up independent supply systems

### MINI AC power terminal block

- For supplying MINI DC/DC converters from unregulated AC networks
- A transformer's AC voltage is rectified and filtered



**DC/DC converter,  
12 - 24 V DC / 24 V DC, 1 A**



**DC/DC converter,  
12 - 24 V DC / 5 - 15 V DC, 2 A**

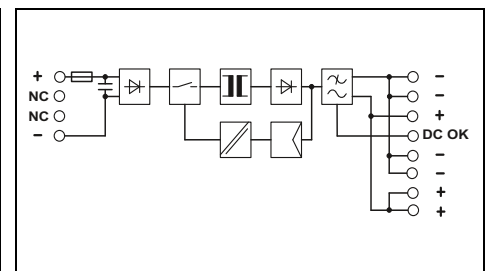
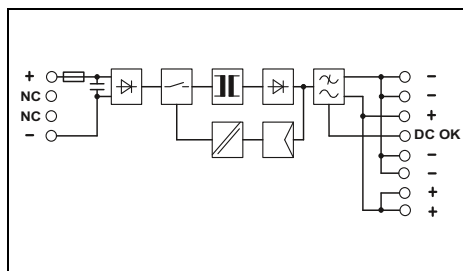

#### Technical data

Input data
Nominal input voltage range
Input voltage range AC/DC
Current consumption (nominal load)
Inrush current limitation at 25°C (typ.) / I <sub>rt</sub>
Output data
Nominal output voltage
Setting range of the output voltage
Output current
Can be connected in parallel / series
Max. power dissipation (no load / nominal load)
Efficiency (typ.)
Residual ripple
Signaling
Signaling DC OK
General data
Weight / Dimensions W x H x D
Spacing when mounting
Connection method
Input connection data (solid/stranded/AWG)
Output connection data (solid/stranded/AWG)
Signal connection data (solid/stranded/AWG)
Degree of protection / Protection class
MTBF (EN 29500, 40°C)
Ambient temperature (operation)
Max. permissible relative humidity (operation)
Standards/regulations
Insulation voltage input/output
Electromagnetic compatibility
Electrical safety
Electronic equipm. for electrical power installations
Safe isolation
UL approvals

12 V DC ... 24 V DC
- / 10 V DC ... 32 V DC
2.6 A (12 V DC) / 1.3 A (24 V DC)
< 15 A / 1.8 A <sup>2s</sup>
24 V DC ±1%
22.5 V DC ... 28.5 V DC (> 24 V constant capacity)
1 A
Yes / Yes
< 1.2 W / < 5 W
> 83 % (at 24 V DC and nominal values)
< 30 mV <sub>pp</sub>
LED, active switching output
0.2 kg / 22.5 x 99 x 107 mm
Can be aligned: Horizontally 0 mm, vertically 50 mm
Plug-in screw connection
0.2 - 2.5 mm <sup>2</sup> / 0.2 - 2.5 mm <sup>2</sup> / 24 - 14
0.2 - 2.5 mm <sup>2</sup> / 0.2 - 2.5 mm <sup>2</sup> / 24 - 14
0.2 - 2.5 mm <sup>2</sup> / 0.2 - 2.5 mm <sup>2</sup> / 24 - 14
IP20 / III
> 2569000 h
-25 °C ... 70 °C (> 60 °C derating)
≤ 95 % (at 25 °C, no condensation)
1 kV (routine test) / 1.5 kV (type test)
Conformance with EMC Directive 2004/108/EC
EN 60950-1/VDE 0805 (SELV)
EN 50178/VDE 0160 (PELV)
DIN VDE 0100-410 , DIN VDE 0106-101
UL/C-UL listed UL 508 , UL/C-UL Recognized UL 60950 ,
UL ANSI/ISA-12.12.01 Class I, Division 2, Groups A, B, C, D
(Hazardous Location)

#### Technical data

12 V DC ... 24 V DC
- / 10 V DC ... 32 V DC
2.3 A (12 V DC) / 1.1 A (24 V DC)
< 10 A / 0.2 A <sup>2s</sup>
12 V DC ±1%
5 V DC ... 15 V DC
2 A
Yes / Yes
< 1 W / < 4.2 W
> 88 % (at 24 V DC and nominal values)
< 20 mV <sub>pp</sub>
LED, active switching output
0.2 kg / 22.5 x 99 x 107 mm
Can be aligned: Horizontally 0 mm, vertically 50 mm
Plug-in screw connection
0.2 - 2.5 mm <sup>2</sup> / 0.2 - 2.5 mm <sup>2</sup> / 24 - 14
0.2 - 2.5 mm <sup>2</sup> / 0.2 - 2.5 mm <sup>2</sup> / 24 - 14
0.2 - 2.5 mm <sup>2</sup> / 0.2 - 2.5 mm <sup>2</sup> / 24 - 14
IP20 / III
> 2072000 h
-25 °C ... 70 °C (> +60 °C derating)
≤ 95 % (At +25°C, no condensation)
1 kV (routine test) / 1.5 kV (type test)
Conformance with EMC Directive 2004/108/EC
EN 60950-1/VDE 0805 (SELV)
EN 50178/VDE 0160 (PELV)
DIN VDE 0100-410 , DIN VDE 0106-101
UL/C-UL listed UL 508 , UL/C-UL Recognized UL 60950

#### Ordering data

Description
<b>DC/DC converter, primary switched mode</b>

Type	Order No.	Pcs. / Pkt.
MINI-PS- 12- 24DC/24DC/1	2866284	1

#### Ordering data

Type	Order No.	Pcs. / Pkt.
MINI-PS- 12- 24DC/ 5-15DC/2	2320018	1



DC/DC converter,  
12 - 24 V DC / 48 V DC, 0.7 A

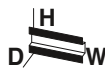

DC/DC converter,  
48 - 60 V DC / 24 V DC, 1 A



AC power terminal for  
MINI DC/DC converter

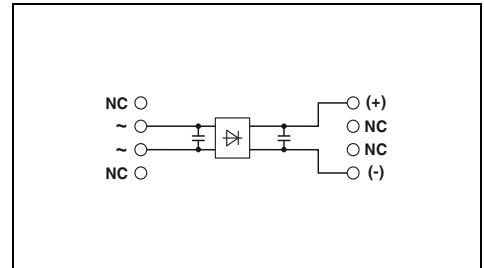
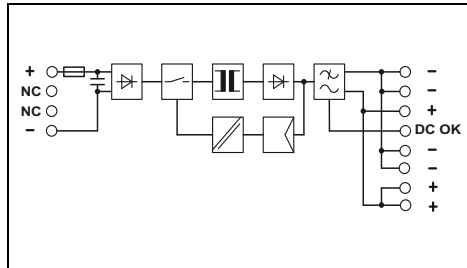
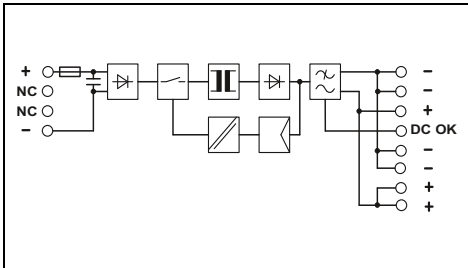

Technical data

12 V DC ... 24 V DC  
- / 10 V DC ... 32 V DC  
3.2 A (12 V DC) / 1.6 A (24 V DC)  
< 10 A / 0.3 A<sup>2s</sup>

48 V DC ±1%  
30 V DC ... 56 V DC (> 48 V constant capacity)

0.7 A  
Yes / Yes  
< 1.5 W / < 4.5 W  
> 87 % (at 24 V DC and nominal values)  
< 20 mV<sub>pp</sub>

LED, active switching output

0.2 kg / 22.5 x 99 x 107 mm  
Can be aligned: Horizontally 0 mm, vertically 50 mm  
Plug-in screw connection  
0.2 - 2.5 mm<sup>2</sup> / 0.2 - 2.5 mm<sup>2</sup> / 24 - 14  
0.2 - 2.5 mm<sup>2</sup> / 0.2 - 2.5 mm<sup>2</sup> / 24 - 14  
0.2 - 2.5 mm<sup>2</sup> / 0.2 - 2.5 mm<sup>2</sup> / 24 - 14  
IP20 / III  
> 1993000 h  
-25 °C ... 70 °C (> +60°C derating)  
≤ 95 % (At +25°C, no condensation)

1 kV (routine test) / 1.5 kV (type test)  
Conformance with EMC Directive 2004/108/EC  
EN 60950-1/VDE 0805 (SELV)  
EN 50178/VDE 0160 (PELV)  
DIN VDE 0100-410, DIN VDE 0106-101  
UL/C-UL listed UL 508, UL/C-UL Recognized UL 60950

Technical data

48 V DC ... 60 V DC  
- / 36 V DC ... 75 V DC  
0.6 A (48 V DC) / 0.5 A (60 V DC)  
< 15 A / 1.8 A<sup>2s</sup>

24 V DC ±1%  
22.5 V DC ... 28.5 V DC (> 24 V constant capacity)

1 A  
Yes / Yes  
< 1.2 W / < 5 W  
> 85 % (at 60 V DC and nominal values)  
< 40 mV<sub>pp</sub>

LED, active switching output

0.2 kg / 22.5 x 99 x 107 mm  
Can be aligned: Horizontally 0 mm, vertically 50 mm  
Plug-in screw connection  
0.2 - 2.5 mm<sup>2</sup> / 0.2 - 2.5 mm<sup>2</sup> / 24 - 14  
0.2 - 2.5 mm<sup>2</sup> / 0.2 - 2.5 mm<sup>2</sup> / 24 - 14  
0.2 - 2.5 mm<sup>2</sup> / 0.2 - 2.5 mm<sup>2</sup> / 24 - 14  
IP20 / II  
> 1147000 h  
-25 °C ... 70 °C (> 60 °C derating)  
≤ 95 % (at 25 °C, no condensation)

1 kV (routine test) / 1.5 kV (type test)  
Conformance with EMC Directive 2004/108/EC  
EN 60950-1/VDE 0805 (SELV)  
EN 50178/VDE 0160 (PELV)  
DIN VDE 0100-410, DIN VDE 0106-101  
UL/C-UL listed UL 508, UL/C-UL Recognized UL 60950,  
UL ANSI/ISA-12.12.01 Class I, Division 2, Groups A, B, C, D  
(Hazardous Location)

Technical data

10 V AC ... 42 V AC  
0 V AC ... 42 V AC  
6.5 A  
< 45 A / 8 A<sup>2s</sup>

24 V DC ±1%  
-

3 A  
Yes / No  
< 0.04 W / < 6.9 W  
> 95.7 % (For 42 V AC and nominal values)  
< 3.6 V<sub>pp</sub>

-

0.16 kg / 22.5 x 99 x 107 mm  
Can be aligned: Horizontally 0 mm, vertically 50 mm  
Plug-in screw connection  
0.2 - 2.5 mm<sup>2</sup> / 0.2 - 2.5 mm<sup>2</sup> / 24 - 12  
0.2 - 2.5 mm<sup>2</sup> / 0.2 - 2.5 mm<sup>2</sup> / 24 - 12  
- / - / -  
IP20 / III  
> 18175000 h  
-25 °C ... 70 °C (> 60 °C derating)  
≤ 95 % (at 25 °C, no condensation)

1 kV (routine test) / 1.5 kV (type test)  
Conformance with EMC Directive 2004/108/EC  
EN 60950-1/VDE 0805 (SELV)  
EN 50178/VDE 0160 (PELV)  
-  
UL/C-UL listed UL 508, UL/C-UL Recognized UL 60950

Ordering data

Type	Order No.	Pcs. / Pkt.
MINI-PS- 12- 24DC/48DC/0.7	2320021	1

Ordering data

Type	Order No.	Pcs. / Pkt.
MINI-PS- 48- 60DC/24DC/1	2866271	1

Ordering data

Type	Order No.	Pcs. / Pkt.
MINI-PS- 10- 42AC/15-60DC/3	2320199	1



### Maximum availability due to redundancy modules

To prevent the effects of errors on the load in a redundant system and increase the operational reliability, power supply units should be decoupled from one another with a redundancy module. Only by doing this, is it possible to ensure that an incorrectly connected power supply unit or a short circuit does not have an effect on the load.

### Simple decoupling with STEP and QUINT DIODE redundancy modules

If the power supply units are decoupled, a short circuit at the output of one of the power supply units or in the supply line from the power supply unit to the diode no longer has any effect on the load.

### Decoupling and monitoring with TRIO DIODE redundancy modules

The redundancy modules check the output voltages of the power supply units, as well as the wiring up to the redundancy module itself. Should one of these pathways short circuit, the load will continue to be supplied. Cable breaks are also detected and reported.

### Decoupling, monitoring, and closed-loop control by means of the QUINT ORING active redundancy modules

The QUINT ORING active redundancy modules monitor the entire redundancy solution. They detect critical operating states and inform the user in good time. For example, faulty wiring or defective cables are reported.



**QUINT ORING redundancy module for maximum system availability**

- Constant monitoring of input voltage, output current, and decoupling section
- ACB technology doubles the service life
- Energy savings of 70% by using MOSFETs over diodes
- Two positive output terminals



**ACB technology doubles the service life**

The ACB (Auto Current Balancing) technology provides symmetrical loading of the power supply units, thereby reducing the operating temperature. This means up to double the service life of the redundant system.



**Continuous monitoring**

QUINT ORING detects critical operating states within the entire supply path and notifies the operator in good time.

- Monitoring
- Power supply unit voltages
- Wiring
- Decoupling section
- Load current



**TRIO DIODE redundancy module**

- Permanent redundancy monitoring
- Consistent redundancy up to the load
- Flexible: nominal voltages of 12 V DC to 48 V DC

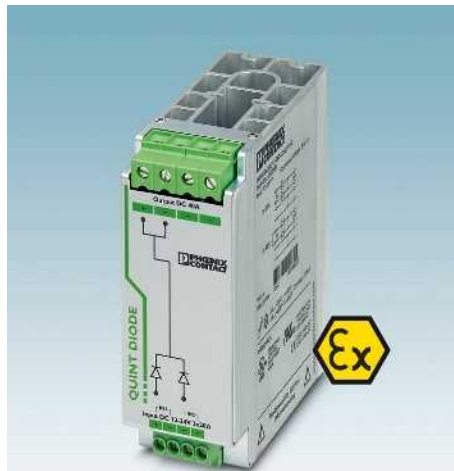

**Redundancy module QUINT DIODE**

- Rugged design for currents of up to 60 A
- Consistent redundancy up to the load
- Flexible: nominal voltages of 12 V DC to 48 V DC



**STEP DIODE redundancy module**

- Space-saving: design width of just 18 mm
- Consistent redundancy up to the load
- Flexible: nominal voltages of 5 V DC to 24 V DC

## Redundancy modules

### QUINT ORING, 24 V DC

- Preventive function monitoring: permanent monitoring of the input voltage, output current, and decoupling section
- Continuous redundancy right through to the load: the use of two Plus output terminal blocks makes it possible to devise a redundant wiring concept that runs right through to the load
- Double the service life of the redundant solution thanks to even load distribution: the ACB (Auto Current Balancing) technology automatically and symmetrically distributes the load current to two power supply units operating in parallel
- Save energy: decoupling is achieved with MOSFETs and results in energy savings of up to 70% compared with conventional diodes
- OVP (Over Voltage Protection): surge voltages are limited to 30 V



**Active redundancy module**  
24 V DC, 2x 10 A, 1x 20 A

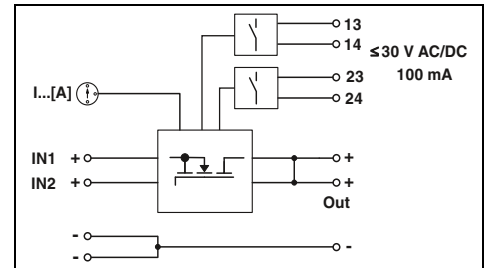

#### Technical data

<b>Input data</b>	24 V DC 18 V DC ... 28 V DC 2x 10 A (-25 °C ... 60 °C) 1x 20 A (-25 °C ... 60 °C) 2x 15 A (-25 °C ... 40 °C) 1x 30 A (-25 °C ... 40 °C)
Nominal input voltage range	
DC input voltage range	
Nominal current	
<b>Maximum current</b>	Varistor 0.1 V ( $I_{OUT} = 20$ A) 2 W ( $I_{OUT} = 20$ A)
Transient surge protection	
Voltage drop, input/output	
Max. power dissipation (nominal load)	
<b>General data</b>	0.4 kg / 32 x 130 x 125 mm Alignable: 5 mm horizontally, 15 mm next to active components, 50 mm vertically Screw connection 0.2 - 4 mm <sup>2</sup> / 0.2 - 2.5 mm <sup>2</sup> / 14 - 12 0.2 - 6 mm <sup>2</sup> / 0.2 - 4 mm <sup>2</sup> / 10 - 10 IP20 / III -25 °C ... 70 °C (> 60 °C derating)
Weight / Dimensions W x H x D	
Spacing when mounting	
Connection method	
Input connection data (solid/stranded/AWG)	
Output connection data (solid/stranded/AWG)	
Degree of protection / Protection class	
Ambient temperature (operation)	
<b>Standards/regulations</b>	500 V Conformance with EMC Directive 2004/108/EC EN 60950-1/VDE 0805 (SELV) EN 50178/VDE 0160 (PELV) UL/C-UL listed UL 508 , UL/C-UL Recognized UL 60950 , UL ANSI/ISA-12.12.01 Class I, Division 2, Groups A, B, C, D (Hazardous Location)
Insulation voltage: input, output/housing	
Electromagnetic compatibility	
Electrical safety	
Electronic equipm. for electrical power installations	
UL approvals	

#### Ordering data

Description	Type	Order No.	Pcs. / Pkt.
<b>Active redundancy module</b>	QUINT-ORING/24DC/2X10/1X20	2320173	1



N



**Active redundancy module**  
24 V DC, 2x 20 A, 1x 40 A



**Active redundancy module**  
24 V DC, 2 x 40 A, 1 x 80 A

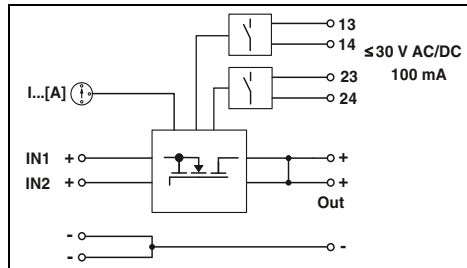
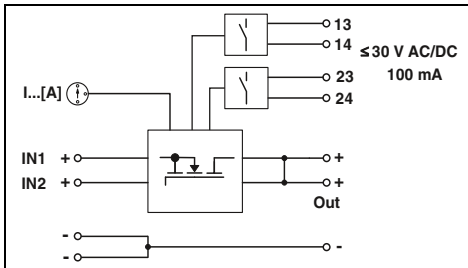

**Technical data**

24 V DC  
18 V DC ... 28 V DC  
2x 20 A (-25 °C ... 60 °C)  
1x 40 A (-25 °C ... 60 °C)  
2x 26 A (-25 °C ... 40 °C)  
1x 52 A (-25 °C ... 40 °C)  
Varistor  
0.2 V (I<sub>OUT</sub> = 40 A)  
8 W (I<sub>OUT</sub> = 40 A)

0.6 kg / 38 x 130 x 125 mm  
Alignable: 5 mm horizontally, 15 mm next to active components, 50 mm vertically  
Screw connection  
0.2 - 6 mm<sup>2</sup> / 0.2 - 4 mm<sup>2</sup> / 10 - 10  
0.5 - 16 mm<sup>2</sup> / 0.5 - 16 mm<sup>2</sup> / 6 - 6  
IP20 / III  
-25 °C ... 70 °C (> 60 °C derating)

500 V  
Conformance with EMC Directive 2004/108/EC  
EN 60950-1/VDE 0805 (SELV)  
EN 50178/VDE 0160 (PELV)  
UL/C-UL listed UL 508 , UL/C-UL Recognized UL 60950 ,  
UL ANSI/ISA-12.12.01 Class I, Division 2, Groups A, B, C, D  
(Hazardous Location)

**Technical data**

24 V DC  
18 V DC ... 28 V DC  
2x 40 A (-25 °C ... 60 °C)  
1x 80 A (-25 °C ... 60 °C)  
2x 45 A (-25 °C ... 40 °C)  
1x 90 A (-25 °C ... 40 °C)  
Varistor  
0.2 V (I<sub>OUT</sub> = 80 A)  
16 W (I<sub>OUT</sub> = 80 A)

0.9 kg / 66 x 130 x 125 mm  
Alignable: 5 mm horizontally, 15 mm next to active components, 50 mm vertically  
Screw connection  
0.5 - 16 mm<sup>2</sup> / 0.5 - 16 mm<sup>2</sup> / 6 - 6  
0.5 - 35 mm<sup>2</sup> / 0.5 - 35 mm<sup>2</sup> / 2 - 2  
IP20 / III  
-25 °C ... 70 °C (> 60 °C derating)

500 V  
Conformance with EMC Directive 2004/108/EC  
EN 60950-1/VDE 0805 (SELV)  
EN 50178/VDE 0160 (PELV)  
UL applied for

**Ordering data**

Type	Order No.	Pcs. / Pkt.
QUINT-ORING/24DC/2X20/1X40	2320186	1

**Ordering data**

Type	Order No.	Pcs. / Pkt.
QUINT-ORING/24DC/2X40/1X80	2902879	1

### TRIO DIODE, 12 - 24 and 48 V DC

- Permanent redundancy monitoring: checking of output voltages of parallel-connected power supplies and of wiring running to the redundancy module
- Continuous redundancy right through to the load: the use of two Plus output terminal blocks makes it possible to devise a redundant wiring concept that runs right through to the load
- Flexible: nominal voltages of 12 V DC to 48 V DC



**Redundancy module,  
12 - 24 V DC, 2 x 10 A, 1 x 20 A**

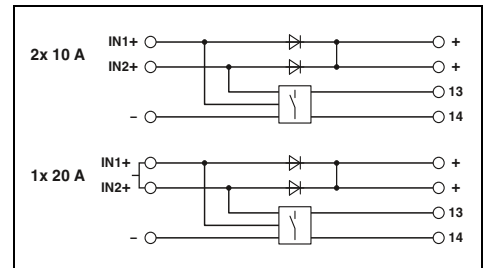

#### Technical data

<b>Input data</b>	12 V DC ... 24 V DC 10 V DC ... 30 V DC DC input voltage range Nominal current  Maximum current  Transient surge protection Voltage drop, input/output Max. power dissipation (nominal load)
<b>General data</b>	Weight / Dimensions W x H x D Spacing when mounting Connection method Input connection data (solid/stranded/AWG) Output connection data (solid/stranded/AWG) Degree of protection / Protection class Ambient temperature (operation) Standards/regulations
<b>Standards/regulations</b>	Insulation voltage: input, output/housing Electromagnetic compatibility Electrical safety, safety transformer Electronic equipm. for electrical power installations UL approvals

2x 10 A IN1+ IN2+ -  1x 20 A IN1+ IN2+ -	+ + 13 14  + + 13 14
12 V DC ... 24 V DC 10 V DC ... 30 V DC 2x 10 A (-25°C ... 55°C) 1x 20 A (-25°C ... 55°C) 2x 15 A (-25°C ... 40°C) 1x 30 A (-25°C ... 40°C) Varistor Approx. 0.5 V 7 W (I <sub>OUT</sub> = 10 A)	0.37 kg / 32 x 130 x 115 mm Can be aligned: Horizontally 0 mm, vertically 50 mm Screw connection 0.2 - 2.5 mm <sup>2</sup> / 0.2 - 2.5 mm <sup>2</sup> / 24 - 14 0.5 - 6 mm <sup>2</sup> / 0.5 - 4 mm <sup>2</sup> / 20 - 10 IP20 / III -25 °C ... 70 °C (> 55° C derating)
500 V Conformance with EMC Directive 2004/108/EC EN 60950-1/VDE 0805 (SELV) EN 50178/VDE 0160 (PELV) UL/C-UL listed UL 508 , UL/C-UL Recognized UL 60950	

#### Ordering data

Description	Type	Order No.	Pcs. / Pkt.
<b>Redundancy module</b>	<b>TRIO-DIODE/12-24DC/2X10/1X20</b>	<b>2866514</b>	<b>1</b>



**Redundancy module**  
48 V DC, 2x 10 A, 1x 20 A

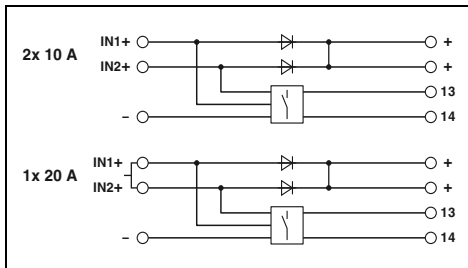

#### Technical data

48 V DC  
30 V AC ... 56 V AC  
2x 10 A (-25°C ... 55°C)  
1x 20 A (-25°C ... 55°C)  
2x 15 A (-25°C ... 40°C)  
1x 30 A (-25°C ... 40°C)  
Varistor  
Approx. 0.65 V  
14 W ( $I_{OUT} = 20$  A)

0.37 kg / 32 x 130 x 115 mm  
Can be aligned: Horizontally 0 mm, vertically 50 mm  
Screw connection  
0.2 - 2.5 mm<sup>2</sup> / 0.2 - 2.5 mm<sup>2</sup> / 24 - 14  
0.5 - 6 mm<sup>2</sup> / 0.5 - 4 mm<sup>2</sup> / 20 - 10  
IP20 / III  
-25 °C ... 70 °C (> 55° C derating)

500 V  
Conformance with EMC Directive 2004/108/EC  
EN 60950-1/VDE 0805 (SELV)  
EN 50178/VDE 0160 (PELV)  
UL/C-UL listed UL 508 , UL/C-UL Recognized UL 60950

#### Ordering data

Type	Order No.	Pcs. / Pkt.
TRIO-DIODE/48DC/2X10/1X20	2866527	1

## Redundancy modules

### QUINT DIODE and STEP DIODE diode modules

#### QUINT DIODE, 12 - 24 V and 48 V DC

- Rugged design for currents of up to 60 A
- Continuous redundancy right through to the load: the use of two Plus output terminal blocks makes it possible to devise a redundant wiring concept that runs right through to the load
- Flexible: nominal voltages of 12 V DC to 48 V DC
- Complies with standard EN 60079-15 and may be installed in a potentially explosive area

#### STEP DIODE

- Space-saving: design width of just 18 mm
- Continuous redundancy right through to the load: the use of two Plus output terminal blocks makes it possible to devise a redundant wiring concept that runs right through to the load
- Flexible: nominal voltages of 5 V DC to 24 V DC



**Diode module**  
12 - 24 V DC, 2x 20 A, 1x 40 A

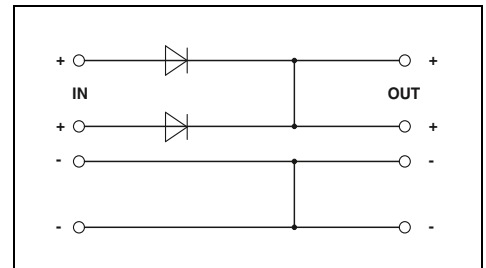

<b>Input data</b>	
Nominal input voltage range	12 V DC ... 24 V DC
DC input voltage range	10 V DC ... 30 V DC
Nominal current	2x 20 A (-25 °C ... 60 °C) 1x 40 A (-25 °C ... 60 °C)
Maximum current	2x 30 A (-25 °C ... 40 °C) 1x 60 A (-25 °C ... 40 °C)
<b>Transient surge protection</b>	
Voltage drop, input/output	0.5 V
Max. power dissipation (nominal load)	10 W (I <sub>OUT</sub> = 20 A)
<b>General data</b>	
Weight / Dimensions W x H x D	0.75 kg / 50 x 130 x 125 mm
Spacing when mounting	Alignable: 5 mm horizontally, 15 mm next to active components, 50 mm vertically
<b>Connection method</b>	
Input connection data (solid/stranded/AWG)	0.2 - 6 mm <sup>2</sup> / 0.2 - 4 mm <sup>2</sup> / 12 - 10
Output connection data (solid/stranded/AWG)	0.5 - 16 mm <sup>2</sup> / 0.5 - 16 mm <sup>2</sup> / 10 - 6
Degree of protection / Protection class	IP20 / III
Ambient temperature (operation)	-40 °C ... 70 °C (> 60 °C derating)
<b>Standards/regulations</b>	
Insulation voltage: input, output/housing	500 V
Electromagnetic compatibility	Conformance with EMC Directive 2004/108/EC
Electrical safety, safety transformer	EN 60950-1/VDE 0805 (SELV)
Electronic equipm. for electrical power installations	EN 50178/VDE 0160 (PELV)
UL approvals	UL/C-UL listed UL 508 , UL/C-UL Recognized UL 60950 , UL ANSI/ISA-12.12.01 Class I, Division 2, Groups A, B, C, D (Hazardous Location)

### Technical data

<b>Technical data</b>	
Nominal input voltage range	12 V DC ... 24 V DC
DC input voltage range	10 V DC ... 30 V DC
Nominal current	2x 20 A (-25 °C ... 60 °C) 1x 40 A (-25 °C ... 60 °C)
Maximum current	2x 30 A (-25 °C ... 40 °C) 1x 60 A (-25 °C ... 40 °C)
<b>Transient surge protection</b>	
Voltage drop, input/output	0.5 V
Max. power dissipation (nominal load)	10 W (I <sub>OUT</sub> = 20 A)
<b>General data</b>	
Weight / Dimensions W x H x D	0.75 kg / 50 x 130 x 125 mm
Spacing when mounting	Alignable: 5 mm horizontally, 15 mm next to active components, 50 mm vertically
<b>Connection method</b>	
Input connection data (solid/stranded/AWG)	0.2 - 6 mm <sup>2</sup> / 0.2 - 4 mm <sup>2</sup> / 12 - 10
Output connection data (solid/stranded/AWG)	0.5 - 16 mm <sup>2</sup> / 0.5 - 16 mm <sup>2</sup> / 10 - 6
Degree of protection / Protection class	IP20 / III
Ambient temperature (operation)	-40 °C ... 70 °C (> 60 °C derating)
<b>Standards/regulations</b>	
Insulation voltage: input, output/housing	500 V
Electromagnetic compatibility	Conformance with EMC Directive 2004/108/EC
Electrical safety, safety transformer	EN 60950-1/VDE 0805 (SELV)
Electronic equipm. for electrical power installations	EN 50178/VDE 0160 (PELV)
UL approvals	UL/C-UL listed UL 508 , UL/C-UL Recognized UL 60950 , UL ANSI/ISA-12.12.01 Class I, Division 2, Groups A, B, C, D (Hazardous Location)

<b>Description</b>
<b>Diode module</b>

<b>Ordering data</b>		
<b>Type</b>	<b>Order No.</b>	<b>Pcs. / Pkt.</b>
QUINT-DIODE/12-24DC/2X20/1X40	2320157	1



**Diode module**  
48 V DC, 2x 20 A, 1x 40 A



**Diode module**  
5 - 24 V DC, 2x 5 A, 1x 10 A

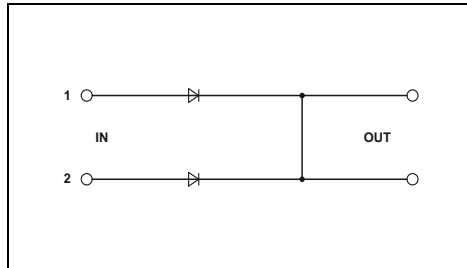
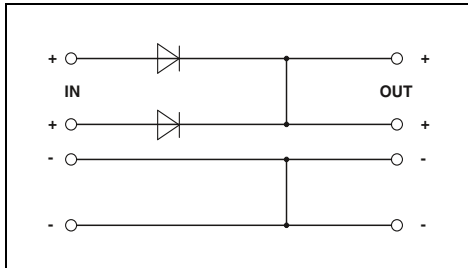

**Technical data**

48 V DC  
30 V DC ... 56 V DC  
2x 20 A (-25 °C ... 60 °C)  
1x 40 A (-25 °C ... 60 °C)  
2x 30 A (-25 °C ... 40 °C)  
1x 60 A (-25 °C ... 40 °C)  
Varistor  
0.7 V  
14 W (I<sub>OUT</sub> = 20 A)

0.75 kg / 50 x 130 x 125 mm  
Alignable: 5 mm horizontally, 15 mm next to active components, 50 mm vertically  
Screw connection  
0.2 - 6 mm<sup>2</sup> / 0.2 - 4 mm<sup>2</sup> / 12 - 10  
0.5 - 16 mm<sup>2</sup> / 0.5 - 16 mm<sup>2</sup> / 10 - 6  
IP20 / III  
-40 °C ... 70 °C (> 60 °C derating)

500 V  
Conformance with EMC Directive 2004/108/EC  
EN 60950-1/VDE 0805 (SELV)  
EN 50178/VDE 0160 (PELV)  
UL/C-UL listed UL 508 , UL/C-UL Recognized UL 60950 ,  
UL ANSI/ISA-12.12.01 Class I, Division 2, Groups A, B, C, D  
(Hazardous Location)

**Ordering data**

Type	Order No.	Pcs. / Pkt.
QUINT-DIODE/48DC/2X20/1X40	2320160	1

**Technical data**

5 V DC ... 24 V DC  
4.5 V DC ... 30 V DC  
2x 5 A (-25 °C ... 55 °C)  
1x 10 A (-25 °C ... 55 °C)  
-  
-  
Transil diode  
0.5 V  
2.5 W (I<sub>OUT</sub> = 5 A)

0.1 kg / 18 x 90 x 61 mm  
Alignable: 0 mm horizontally, 30 mm vertically  
Screw connection  
0.2 - 2.5 mm<sup>2</sup> / 0.2 - 2.5 mm<sup>2</sup> / 24 - 12  
0.2 - 2.5 mm<sup>2</sup> / 0.2 - 2.5 mm<sup>2</sup> / 24 - 12  
IP20 / III  
-25 °C ... 70 °C (> 55 °C derating)

500 V  
Conformance with EMC Directive 2004/108/EC  
IEC 60950-1/VDE 0805 (SELV)  
EN 50178/VDE 0160 (PELV)  
UL/C-UL listed UL 508 , UL/C-UL Recognized UL 60950

**Ordering data**

Type	Order No.	Pcs. / Pkt.
STEP-DIODE/5-24DC/2X5/1X10	2868606	1

# Power supply units and UPS

## Power supply unit accessories

### Mounting on S7-300 rail

To supply a SIMATIC® S7-300 control unit, QUINT POWER 2.5 A, 5 A, and 10 A are mounted on the S7 rail using a QUINT-PS-ADAPTER-S7.

No further accessories are required for fastening.



	Technical data			Technical data		
	Dimensions W x H x D Material	74 / 130 / 11 mm Aluminum			104 / 130 / 11 mm Aluminum	
Description	Ordering data			Ordering data		
	Type	Order No.	Pcs. / Pkt.	Type	Order No.	Pcs. / Pkt.
Adapter for S7-300 rail mounting, for: QUINT-PS/1AC/24DC/3.5 QUINT-PS/1AC/24DC/5 QUINT-PS/3AC/24DC/5	QUINT-PS-ADAPTERS7/1	2938196	1			
Adapter for S7-300 rail mounting, for: QUINT-PS/1AC/24DC/10 QUINT-PS/3AC/24DC/10 QUINT-PS/3AC/24DC/20				QUINT-PS-ADAPTERS7/2	2938206	1

## Fans

With the standard power supply mounting position, the temperature range increases by 10 K (max. ambient temperature of 70°C), when the mounting position is rotated, position-dependent derating no longer applies.

– assembly without tools



	Technical data		
	Dimensions W x H x D Material	41 / 27 / 42.2 mm V0 (UL 94)	
Description	Ordering data		
	Type	Order No.	Pcs. / Pkt.
Fan for QUINT POWER SFB, 24 V DC	QUINT-PS/FAN/4	2320076	1

Universal wall adapter

Adapter for mounting on even surfaces



Dimensions W x H x D  
Material

Technical data		
52 / 182 / 9 mm		
Steel, powder-coated		

Technical data		
25 / 130 / 17 mm		
Steel, powder-coated		

Description

**Universal panel adapter**, for direct panel mounting of the TRIO-PS (from 10 A), QUINT-PS, QUINT-DC-UPS, QUINT-BUFFER power supply units

**Universal wall adapter**, for direct panel mounting of the QUINT-PS/1AC/24DC/40 and QUINT-UPS/1AC/1AC/500VA power supply units

Ordering data		
Type	Order No.	Pcs. / Pkt.
UWA 182/52	2938235	1

Ordering data		
Type	Order No.	Pcs. / Pkt.
UWA 130	2901664	1

Plug-in thermomagnetic circuit breakers

- Device circuit breakers for protecting against overcurrents and short circuits
- SFB characteristic curve enables longer cables and release times < 10 ms
- Maximum ease of maintenance thanks to the two-piece design
- Further circuit breakers can be found from page 259 onwards



Can be plugged in, SFB characteristic curve

Dimensions W / H / D  
Degree of protection

Technical data		
12.3 mm / 90 mm / 77.3 mm		
IP30 (Actuation area)		

Description	Nominal current
<b>Thermomagnetic circuit breaker</b> , plug-in, 1-pos., signal contact 1 PDT	0.5 A
	1 A
	2 A
	3 A
	4 A
	5 A
	6 A

Ordering data		
Type	Order No.	Pcs. / Pkt.
CB TM1 0.5A SFB P	2800835	1
CB TM1 1A SFB P	2800836	1
CB TM1 2A SFB P	2800837	1
CB TM1 3A SFB P	2800838	1
CB TM1 4A SFB P	2800839	1
CB TM1 5A SFB P	2800840	1
CB TM1 6A SFB P	2800841	1

Accessories		
<b>Base element</b> , for accommodating CB TM.../CB E... device circuit breakers		
With push-in connection technology	CB 1/6-2/4 PT-BE	2800929 10
With screw connection technology	CB 1/10-1/10 UT-BE	2801305 10



### The intelligent UPS system ensures maximum system availability

Uninterruptible power supply (UPS) units continue to deliver power even if the supply network goes down. An uninterruptible solution consists of the three function units shown:

- Power supply
- UPS module
- Power storage

### QUINT UPS-IQ

IQ technology is the key to an intelligent power supply solution. The uninterruptible power supply unit monitors and optimizes the power storage. Avoid interruptions when working with the intelligent UPS for non-stop power.

- **SOC (state of charge)** keeps you informed of the charging state and remaining runtime of your battery at all times
- **SOH (state of health)** reports remaining life expectancy of the power storage device, warns of failure at an early stage
- **SOF (state of function)** determines the current performance capability of the power storage device.

### Practical example

An industrial PC must be continuously supplied with 24 V DC.

#### Previous solution:

The UPS with 3.4 Ah buffers 24 V DC/5 A for 20 minutes under optimum conditions.

Can the power storage device actually bridge this time?

Charging state, performance, and remaining runtime of the power storage device are unknown.

#### The solution is the QUINT UPS-IQ:

The intelligent UPS determines all relevant power storage device states. This ensures the crucial transparency required to guarantee the stability of the supply and optimum use of the power storage device at all times.

The intelligent battery management detects the current charging state of the connected power storage device and uses this to calculate the remaining runtime.

The QUINT UPS-IQ also indicates whether the buffer time is actually 20 minutes. As soon as an adjustable threshold value is reached, a warning message is sent via the floating relay contact, the software or directly to higher-level controllers. The IPC continues working for as long as possible

and is shut down before the battery voltage runs out.





**IQ technology**

The IQ technology is intuitive and provides you with information as soon as it is required.

- Intelligent battery management with SOC, SOH, and SOF
- Intelligent battery control
- Intelligent charging
- Data port



**Signaling and configuration**

The UPS-CONF configuration and management software allows you to monitor and configure your UPS system. The software can be downloaded free of charge at: [www.phoenixcontact.net/products](http://www.phoenixcontact.net/products).

- Flexible adaptation of QUINT UPS-IQ behavior to individual requirements
- Monitoring and data recorder



**Communication**

The data cables allow you to integrate the UPS module into your application. You can therefore benefit from all the advantages of IQ technology and be kept informed of the state of your UPS solution. The information provided by QUINT UPS-IQ can, for example, be forwarded to higher-level controllers via Ethernet or be implemented directly in control solutions from Phoenix Contact.



**Modular solution**

1. Choose your power supply unit, e.g., QUINT POWER
2. Choose your UPS module QUINT UPS-IQ
3. Choose your power storage device:
  - UPS-CAP for maximum service life
  - UPS-BAT/LI-ION for long service life with long buffer times
  - UPS-BAT/VRLA and VRLA-WTR for maximum buffer times



**UPS with integrated power storage**

Particularly space-saving and easy to retrofit, the UPS module and power storage device are combined in the same housing.

- QUINT UPS: power storage device with lead AGM technology
- STEP UPS: LiPo-based power storage device
- QUINT BUFFER buffer module: capacitor-based power storage device



**UPS with integrated power supply unit**

The UPS module and power supply unit in a single housing is a space-saving solution. Only one power storage device is required to complete the UPS system.

- MINI UPS: for 24 or 12 V DC
- TRIO UPS: for 24 DC

# Power supply units and UPS

## Uninterruptible power supply units for the control cabinet

### Selecting the power storage device for QUINT UPS-IQ

You can always find the ideal solution for maximum system availability with the new modular system for uninterruptible power supply units. The various storage media feature a wide range of different properties: long service life or a very long buffer time, no maintenance or use at extreme ambient temperatures. Whatever your requirements, we have the ideal power storage device.

#### Your advantages

- Fast installation**
- Automatic detection of the power storage device by QUINT UPS-IQ
  - Tool-free replacement during operation
- Maximum availability**
- Constant communication with QUINT UPS-IQ for continuous monitoring and intelligent management
- Extremely long service life**
- Optimum charging characteristic according to the technology and ambient conditions

Type	Buffer time (typical)	Temperature	Service life At 20°C	Service life At 50°C	Charging cycles At 20°C	Weight (standardized)
UPS-CAP...	< 5 min.	-40 ... 60°C	> 20 years	8 years	> 500,000	0.4 kg
UPS-BAT/LI-ION...	> 40 min.	-20 ... 58°C	15 years	2 years	7000	0.45 kg
UPS-BAT/VRLA-WTR...	> 5 h	-40 ... 60°C	15 years	1.5 years	300	1.3 kg
UPS-BAT/VRLA...	> 8 h	0 ... 40°C	6 ... 9 years	1 year	250	1 kg



**UPS-BAT/VRLA... (Valve Regulated Lead Acid)**

- Maximum buffer times
- Lead AGM (Absorbent Glass Mat) technology



**UPS-BAT/VRLA-WTR... (Valve Regulated Lead Acid/Wide Temperature Range)**

- Maximum buffer times at extreme temperatures
- Pure lead AGM (Absorbent Glass Mat) technology



**UPS-BAT/LI-ION...**

- Long service life with long buffer times
- Lithium-ion technology



Immediate availability:  
All power storage devices leave our warehouse fully charged



**UPS-CAP (Capacitor)**

- Maximum service life
- Maintenance-free double-layer capacitors

Selection of power storage devices with capacitors, lithium ion, and pure lead AGM technology

Buffer times for DC UPS modules

Select your UPS-BAT and UPS-CAP for 24 V DC applications here.

Example: 20 A needs to be buffered for 6 minutes.

Solution: UPS-BAT/LI-ION/24DC/120WH

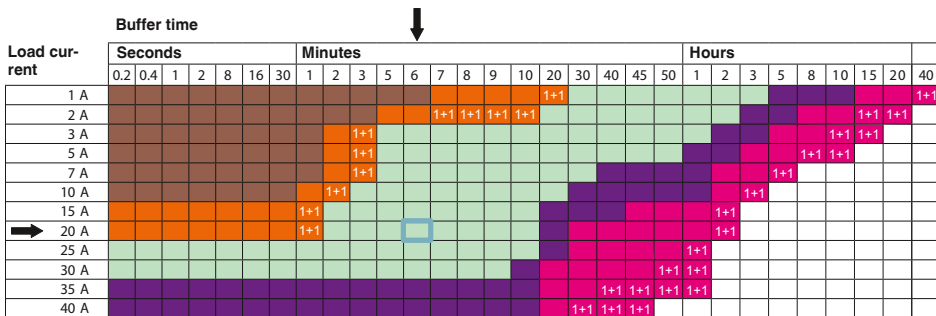

Buffer times for AC UPS modules

Select your UPS-BAT and UPS-CAP for 120 V AC/230 V AC applications here.

Example: 125 W needs to be buffered for one hour.

Solution: UPS-BAT/VRLA-WTR/24DC/13AH

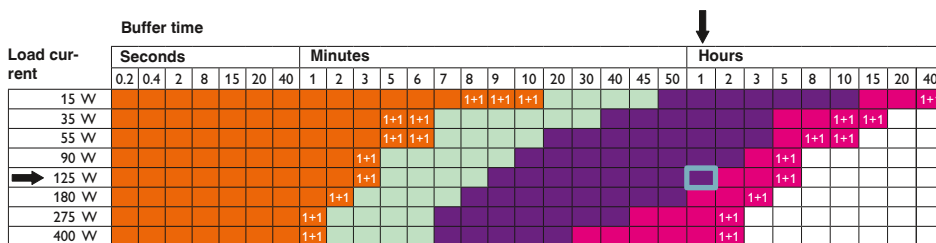

- UPS-CAP power storage device:
  - UPS-CAP/24DC/10A/10KJ
  - UPS-CAP/24DC/20A/20KJ
- UPS-BAT/VRLA-WTR power storage device:
  - UPS-BAT/VRLA-WTR/24DC/13AH
  - UPS-BAT/VRLA-WTR/24DC/26AH
- UPS-BAT/LI-ION power storage device:
  - UPS-BAT/LI-ION/24DC/120WH

Selection of power storage devices with lead AGM technology

Buffer times for DC UPS modules

Select your UPS-BAT for 24 V DC applications here.

Example: 20 A needs to be buffered for 10 minutes.

Solution: UPS-BAT/VRLA/24DC/7.2AH

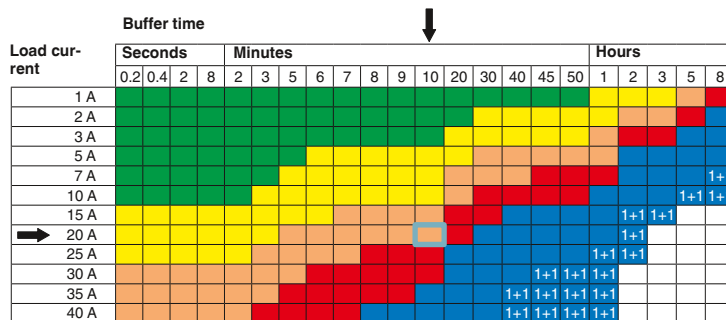

Buffer times for AC UPS modules

Select your UPS-BAT for 120 V AC/230 V AC applications here.

Example: 125 W needs to be buffered for one hour.

Solution: UPS-BAT/VRLA/24DC/12AH

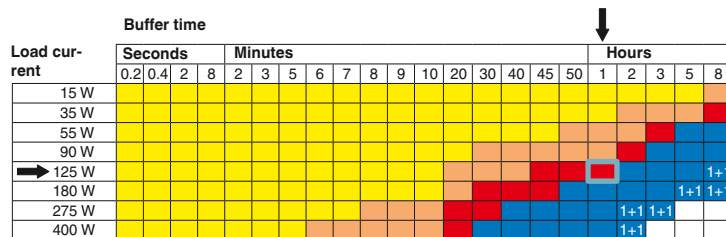

- UPS-BAT/VRLA power storage device:
  - UPS-BAT/VRLA/24DC/1.3AH
  - UPS-BAT/VRLA/24DC/3.4AH
  - UPS-BAT/VRLA/24DC/7.2AH
  - UPS-BAT/VRLA/24DC/12AH
  - UPS-BAT/VRLA/24DC/38AH

1+1 ... Two rechargeable battery modules of the same capacity are required in this case. The data is based on an ambient temperature of 20°C.

# Power supply units and UPS

## Uninterruptible power supply units for the control cabinet

### QUINT UPS-IQ for DC applications

The UPS module for 24 V DC with output currents ranging from 5 to 40 A allows you to create a custom solution combining power supply unit, UPS module, and power storage device.

Optimum use of the buffer time and preventive monitoring of the power storage device:

- Detects the current charging state of the power storage device and calculates the remaining runtime
- Calculates the current life expectancy of the power storage device

Substantial power reserve:

- For mains and battery operation
- POWER BOOST static power reserve
- Dynamic power reserve with SFB (Selective Fuse Breaking) technology

Fast battery charging:

- Adaptive current management charges the power storage device twice as fast as before, while simultaneously providing sufficient energy for the loads.

Extensive signaling and parameterization:

- Floating relay contacts
- Data port
- Parameterization with memory block

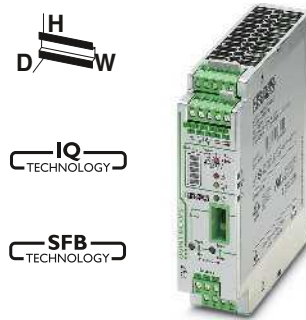

Uninterruptible power supply, 24 V DC / 24 V DC, 5 A

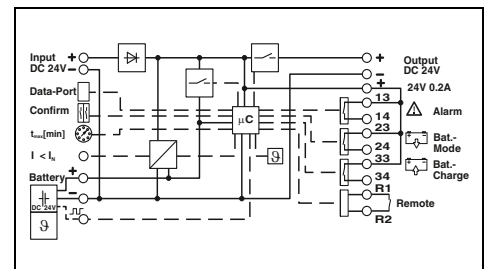

#### Technical data

<b>Input data</b>	24 V DC 18 V DC ... 30 V DC 9.4 A (Maximum, mains operation)
<b>Output data (mains operation)</b>	24 V DC 18 V DC ... 30 V DC > 98 % (Mains operation, with charged power storage)
<b>Output current with convection cooling</b>	5 A (-25 °C ... 60 °C) 30 A (-25 °C ... 60 °C) 7.5 A (-25 °C ... 40 °C)
<b>Output data (battery operation)</b>	24 V DC 19.2 V DC ... 27.6 V DC ( $U_{OUT} = U_{BAT} - 0.5 V DC$ )
<b>Output current with convection cooling</b>	5 A (-25 °C ... 60 °C) 32.5 A (-25 °C ... 60 °C) 7.5 A (-25 °C ... 40 °C)
<b>Power storage device</b>	24 V DC 24 V DC ... 29 V DC (temperature compensated) 0.8 Ah ... 140 Ah 0.2 A ... 1.36 A
<b>Signaling</b>	LED, relay contact, interface/software IFS (Interface system data port)
<b>General data</b>	0.5 kg / 35 x 130 x 125 mm Plug-in screw connection 0.2 - 2.5 mm <sup>2</sup> / 0.2 - 2.5 mm <sup>2</sup> / 20 - 12 0.2 - 2.5 mm <sup>2</sup> / 0.2 - 2.5 mm <sup>2</sup> / 20 - 12 0.2 - 2.5 mm <sup>2</sup> / 0.2 - 2.5 mm <sup>2</sup> / 24 - 12 IP20 / III -25 °C ... 70 °C -40 °C ... 85 °C 60 °C ... 70 °C (2.5%/K) ≤ 95 % (25 °C, no condensation)
<b>Standards/regulations</b>	UL/C-UL Recognized UL 60950, UL Listed UL 508

#### Ordering data

Description	Type	Order No.	Pcs. / Pkt.
Power supply, uninterruptible	QUINT-UPS/ 24DC/ 24DC/ 5	2320212	1

## Uninterruptible power supply units for the control cabinet



Uninterruptible power supply,  
24 V DC / 24 V DC, 10 A



Uninterruptible power supply,  
24 V DC / 24 V DC, 20 A



Uninterruptible power supply,  
24 V DC / 24 V DC, 40 A

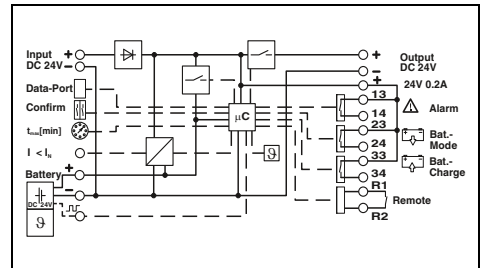
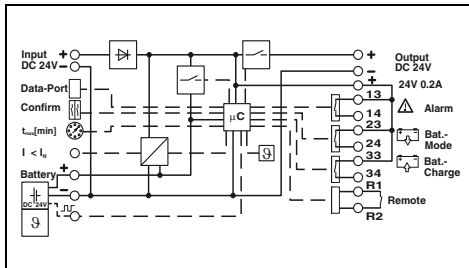
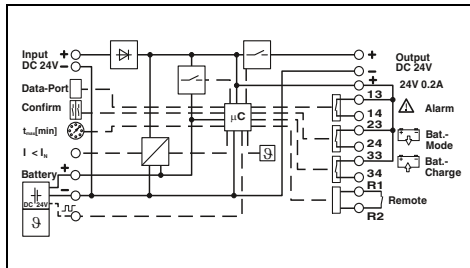

### Technical data

24 V DC  
18 V DC ... 30 V DC  
19 A (Maximum, mains operation)

24 V DC  
18 V DC ... 30 V DC  
> 98 % (Mains operation, with charged power storage)

10 A (-25 °C ... 60 °C)  
60 A (-25 °C ... 60 °C)  
15 A (-25 °C ... 40 °C)

24 V DC  
19.2 V DC ... 27.6 V DC ( $U_{OUT} = U_{BAT} - 0.5 \text{ V DC}$ )

10 A (-25 °C ... 60 °C)  
65 A (-25 °C ... 60 °C)  
15 A (-25 °C ... 40 °C)

24 V DC  
24 V DC ... 29 V DC (temperature compensated)  
1.3 Ah ... 140 Ah  
0.2 A ... 2.88 A

LED, relay contact, interface/software  
IFS (Interface system data port)

0.5 kg / 35 x 130 x 125 mm  
Plug-in screw connection  
0.2 - 2.5 mm<sup>2</sup> / 0.2 - 2.5 mm<sup>2</sup> / 16 - 12  
0.2 - 2.5 mm<sup>2</sup> / 0.2 - 2.5 mm<sup>2</sup> / 16 - 12  
0.2 - 2.5 mm<sup>2</sup> / 0.2 - 2.5 mm<sup>2</sup> / 24 - 12  
IP20 / III  
-25 °C ... 70 °C  
-40 °C ... 85 °C  
60 °C ... 70 °C (2.5%/K)  
≥ 95 % (25 °C, no condensation)

UL/C-UL Recognized UL 60950, UL Listed UL 508

### Technical data

24 V DC  
18 V DC ... 30 V DC  
32.9 A (Maximum, mains operation)

24 V DC  
18 V DC ... 30 V DC  
> 98 % (Mains operation, with charged power storage)

20 A (-25 °C ... 60 °C)  
120 A (-25 °C ... 60 °C)  
26 A (-25 °C ... 40 °C)

24 V DC  
19.2 V DC ... 27.6 V DC ( $U_{OUT} = U_{BAT} - 0.5 \text{ V DC}$ )

20 A (-25 °C ... 60 °C)  
120 A (-25 °C ... 60 °C)  
27 A (-25 °C ... 40 °C)

24 V DC  
24 V DC ... 29 V DC (temperature compensated)  
3 Ah ... 200 Ah  
0.2 A ... 5 A

LED, relay contact, interface/software  
IFS (Interface system data port)

0.6 kg / 40 x 130 x 125 mm  
Screw connection  
0.2 - 6 mm<sup>2</sup> / 0.2 - 4 mm<sup>2</sup> / 12 - 10  
0.2 - 6 mm<sup>2</sup> / 0.2 - 4 mm<sup>2</sup> / 12 - 10  
0.2 - 4 mm<sup>2</sup> / 0.2 - 2.5 mm<sup>2</sup> / 24 - 12  
IP20 / III  
-25 °C ... 70 °C  
-40 °C ... 85 °C  
60 °C ... 70 °C (2.5%/K)  
≤ 95 % (25 °C, no condensation)

UL/C-UL Recognized UL 60950, UL Listed UL 508

### Technical data

24 V DC  
18 V DC ... 30 V DC  
51.9 A (Maximum, mains operation)

24 V DC  
18 V DC ... 30 V DC  
> 99 % (Mains operation, with charged power storage)

40 A (-25 °C ... 50 °C)  
215 A (-25 °C ... 60 °C)  
45 A (-25 °C ... 40 °C)

24 V DC  
19.2 V DC ... 27.6 V DC ( $U_{OUT} = U_{BAT} - 0.5 \text{ V DC}$ )

40 A (-25 °C ... 60 °C)  
215 A (-25 °C ... 60 °C)  
45 A (-25 °C ... 40 °C)

24 V DC  
24 V DC ... 29 V DC (temperature compensated)  
7 Ah ... 200 Ah  
0.2 A ... 5 A

LED, relay contact, interface/software  
IFS (Interface system data port)

0.7 kg / 47 x 130 x 125 mm  
Screw connection  
0.5 - 16 mm<sup>2</sup> / 0.5 - 16 mm<sup>2</sup> / 8 - 6  
0.5 - 16 mm<sup>2</sup> / 0.5 - 16 mm<sup>2</sup> / 8 - 6  
0.2 - 4 mm<sup>2</sup> / 0.2 - 2.5 mm<sup>2</sup> / 24 - 12  
IP20 / III  
-25 °C ... 70 °C  
-40 °C ... 85 °C  
60 °C ... 70 °C (2.5%/K)  
≤ 95 % (25 °C, no condensation)

UL/C-UL Recognized UL 60950, UL Listed UL 508

### Ordering data

Type	Order No.	Pcs. / Pkt.
QUINT-UPS/24DC/24DC/10	2320225	1

### Ordering data

Type	Order No.	Pcs. / Pkt.
QUINT-UPS/24DC/24DC/20	2320238	1

### Ordering data

Type	Order No.	Pcs. / Pkt.
QUINT-UPS/24DC/24DC/40	2320241	1

# Power supply units and UPS

## Uninterruptible power supply units for the control cabinet

### QUINT UPS-IQ for DC applications with dual output voltage

The UPS module for two output voltages, 12 and 24 V DC, allows you to create a custom solution combining power supply unit, UPS module, and power storage device.

- Flexible and space-saving thanks to the two output voltages in one unit

Optimum use of the buffer time and preventive monitoring of the power storage device:

- Detects the current charging state of the power storage device and calculates the remaining runtime
- Calculates the current life expectancy of the power storage device

Substantial power reserve:

- For mains and battery operation
- POWER BOOST static power reserve
- Dynamic power reserve with SFB (Selective Fuse Breaking) technology

Fast battery charging:

- Adaptive current management charges the power storage device twice as fast as before, while simultaneously providing sufficient energy for the loads.

Extensive signaling and parameterization:

- Floating relay contacts
- Data port
- Parameterization with memory block



N

Uninterruptible power supply, 24 V DC/12 V DC, 5 A and 24 V DC, 10 A

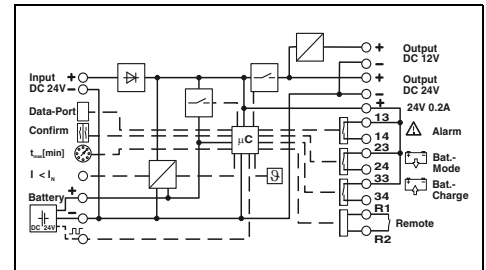

Input data	
Nominal input voltage	24 V DC
DC input voltage range	18 V DC ... 30 V DC
Max. current consumption	16 A
Output data (mains operation)	
Nominal output voltage	24 V DC
Output voltage range	12 V DC 24 V DC 18 V DC ... 30 V DC ( $U_{OUT} = U_{IN} - 0.5 \text{ V DC}$ )
Efficiency (typ.)	> 93 % (Mains operation, with charged power storage) > 98 % (Mains operation, with charged power storage)
Output current with convection cooling ( $P_{max} = P_{12V} + P_{24V} = 360 \text{ W}$ )	
- Nominal output current $I_N$ (continual)	5 A (-25 °C ... 60 °C)      10 A (-25 °C ... 60 °C)
- SFB technology (15 ms)	7.5 A (-25 °C ... 40 °C)      60 A (-25 °C ... 60 °C)
- POWER BOOST $I_{BOOST}$ (continual)	15 A (-25 °C ... 40 °C)
Output data (battery operation)	
Nominal output voltage	24 V DC
Output voltage range	12 V DC 24 V DC 19.2 V DC ... 27.6 V DC ( $U_{OUT} = U_{BAT} - 0.5 \text{ V DC}$ )
Output current with convection cooling ( $P_{max} = P_{12V} + P_{24V} = 360 \text{ W}$ )	
- Nominal output current $I_N$ (continual)	5 A (-25 °C ... 60 °C)      10 A (-25 °C ... 60 °C)
- SFB technology (15 ms)	7.5 A (-25 °C ... 60 °C)      65 A (-25 °C ... 60 °C)
- POWER BOOST $I_{BOOST}$ (continual)	15 A (-25 °C ... 60 °C)
Power storage device	
Nominal voltage $U_N$	24 V DC
End-of-charge voltage	24 V DC ... 29 V DC (temperature compensated)
Nominal capacity range	1.3 Ah ... 140 Ah
Max. charging current	2.88 A
Signaling	
Signaling	LED, relay contact, interface/software
Interfaces	IFS (Interface system data port)
General data	
Weight / Dimensions W x H x D	0.6 kg / 35 x 130 x 125 mm
Connection method	Plug-in screw connection
Connection data input/output solid/stranded/AWG	0.2 - 2.5 mm <sup>2</sup> / 0.2 - 2.5 mm <sup>2</sup> / 16 - 12
Signal connection data (solid/stranded/AWG)	0.2 - 2.5 mm <sup>2</sup> / 0.2 - 2.5 mm <sup>2</sup> / 24 - 12
Degree of protection / Protection class	IP20 / III
Ambient temperature (operation)	-25 °C ... 70 °C
Derating	60 °C ... 70 °C (2.5%/K)
Standards/regulations	
UL approvals	UL Listed UL 508 , UL/C-UL Recognized UL 60950

Technical data		
	24 V DC	
	18 V DC ... 30 V DC	
	16 A	
12 V DC	24 V DC	
12 V DC	24 V DC	
	18 V DC ... 30 V DC	
	( $U_{OUT} = U_{IN} - 0.5 \text{ V DC}$ )	
> 93 % (Mains operation, with charged power storage)	> 98 % (Mains operation, with charged power storage)	
5 A (-25 °C ... 60 °C)	10 A (-25 °C ... 60 °C)	
7.5 A (-25 °C ... 40 °C)	15 A (-25 °C ... 40 °C)	
12 V DC	24 V DC	
12 V DC	24 V DC	
-	19.2 V DC ... 27.6 V DC	
	( $U_{OUT} = U_{BAT} - 0.5 \text{ V DC}$ )	
5 A (-25 °C ... 60 °C)	10 A (-25 °C ... 60 °C)	
7.5 A (-25 °C ... 60 °C)	65 A (-25 °C ... 60 °C)	
	15 A (-25 °C ... 60 °C)	
	24 V DC	
	24 V DC ... 29 V DC (temperature compensated)	
	1.3 Ah ... 140 Ah	
	2.88 A	
	LED, relay contact, interface/software	
	IFS (Interface system data port)	
	0.6 kg / 35 x 130 x 125 mm	
	Plug-in screw connection	
	0.2 - 2.5 mm <sup>2</sup> / 0.2 - 2.5 mm <sup>2</sup> / 16 - 12	
	0.2 - 2.5 mm <sup>2</sup> / 0.2 - 2.5 mm <sup>2</sup> / 24 - 12	
	IP20 / III	
	-25 °C ... 70 °C	
	60 °C ... 70 °C (2.5%/K)	
	UL Listed UL 508 , UL/C-UL Recognized UL 60950	

Ordering data		
Type	Order No.	Pcs. / Pkt.
QUINT-UPS/24DC/12DC/5/24DC/10	2320461	1

Description	Power supply, uninterruptible
-------------	-------------------------------

**QUINT UPS-IQ for AC applications**

The UPS module for 120 V AC/230 V AC with 400 W/500 VA power can be combined with all UPS-CAP and UPS-BAT power storage devices.

Optimum use of the buffer time and preventive monitoring of the power storage device:

- Detects the current charging state of the power storage device and calculates the remaining runtime
- Calculates the current life expectancy of the power storage device

Worldwide use:

- Input voltages from 96 to 264 V AC
- Storage of the level and frequency of the input voltage, in the event of mains failure, the output is automatically supplied with 120 V AC/60 Hz or 230 V AC/50 Hz
- Manual voltage pre-selection possible

Maximum energy efficiency:

- Offline operation: 98% efficiency for charged power storage device

Extensive signaling and parameterization:

- Switching outputs
- USB interface
- Data port
- Parameterization with memory block

Simplified startup:

- The UPS can be switched on without a power supply network



**Uninterruptible power supply,  
1 AC / 1 AC, 500 VA**

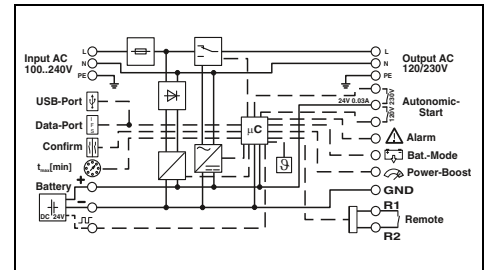

**Technical data**

General input data	80 V AC ... 264 V AC 45 Hz ... 65 Hz $U_N \pm 10\%$ . Can be configured using UPS-CONF software.	
Input data	120 V AC	230 V AC
Nominal input voltage	120 V AC	230 V AC
AC input voltage range	80 V AC ... 150 V AC	180 V AC ... 264 V AC
Nominal frequency	60 Hz	50 Hz
Max. current consumption ( $I_{IN} = I_{CHARGE} + I_{BOOST}$ )	6.8 A	3.7 A
General output data	400 W / 500 VA > 50 °C ... 70 °C (2.5%/K) < 10 ms > 98 % (Mains operation)	
Output data (mains operation)	120 V AC	230 V AC
Nominal output voltage	120 V AC	230 V AC
Output voltage range	96 V AC ... 144 V AC	184 V AC ... 276 V AC
- Nominal output current $I_N$ (continual)	4.3 A (-25 °C ... 70 °C)	2.2 A (-25 °C ... 70 °C)
- POWER BOOST $I_{BOOST}$ (continual)	5.2 A (-25 °C ... 70 °C)	2.7 A (-25 °C ... 70 °C)
Output data (battery operation)	120 V AC	230 V AC
Nominal output voltage	120 V AC	230 V AC
- Nominal output current $I_N$ (continual)	4.3 A (-25 °C ... 50 °C)	2.2 A (-25 °C ... 50 °C)
- POWER BOOST $I_{BOOST}$ (5 s)	5.2 A (-25 °C ... 50 °C)	2.7 A (-25 °C ... 50 °C)
Power storage device	24 V DC 25 V DC ... 30 V DC (temperature compensated) 3 Ah ... 200 Ah 0.2 A ... 2 A	
Signaling	LED, active switching outputs, interface/software	
Interfaces	IFS (Interface system data port) , MINI-USB type B	
General data	VFD-SS-311 2.2 kg / 125 x 130 x 125 mm Screw connection 1.5 - 6 mm <sup>2</sup> / 1.5 - 4 mm <sup>2</sup> / 18 - 10	
Classification according to IEC 62040-3		
Weight / Dimensions W x H x D		
Connection method		
Connection data input/output solid/stranded/AWG		
Signal connection data (solid/stranded/AWG)	0.2 - 2.5 mm <sup>2</sup> / 0.2 - 2.5 mm <sup>2</sup> / 24 - 10	
Degree of protection / Protection class	IP20 / I	
Ambient temperature (operation)	-25 °C ... 70 °C (> 50°C derating)	
Standards/regulations	UL/C-UL Recognized UL 1778	
UL approvals		

**Ordering data**

Description	Type	Order No.	Pcs. / Pkt.
Power supply, uninterruptible	QUINT-UPS/ 1AC/1AC/500VA	2320270	1

# Power supply units and UPS

## Uninterruptible power supply units for the control cabinet

### Power storage device for QUINT UPS-IQ

#### Maintenance-free CAP UPS

- Dual layer capacitors
- Life expectancy: >20 years (20°C), >8 years (50°C)
- Communication with QUINT UPS-IQ
- Integrated temperature sensor
- Works reliably, even under extreme ambient temperatures of -40°C to +60°C



Maintenance-free power storage device,  
24 V DC, 10 A, 10 kJ



Maintenance-free power storage device,  
24 V DC, 20 A, 20 kJ

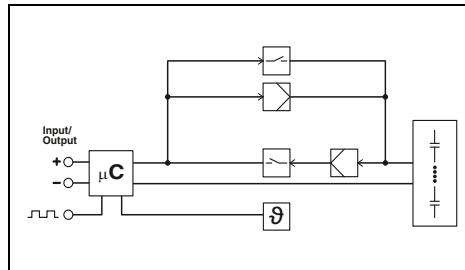

#### Technical data

Input data	
Nominal input voltage	24 V DC
DC input voltage range	18 V DC ... 30 V DC
Nominal capacity	10 kJ
Output data	
Nominal output voltage	24 V DC
Output voltage range	22 V DC ... 27 V DC
Output current	10 A
Output fuse	1x 25 A (internal)
Can be connected in parallel / series	Yes / No
Buffer period	6 min (1 A) / 33 s (10 A)
General data	
Storage medium	Dual layer capacitor
Weight / Dimensions W x H x D	1.7 kg / 126 x 130 x 126 mm
Degree of protection / Protection class	IP20 / III
Ambient temperature (operation)	-40 °C ... 60 °C
Ambient temperature (storage/transport)	-40 °C ... 60 °C
Service life	20 Years (20°C)
Standards/regulations	
UL approvals	UL Listed UL 508 , UL/C-UL Recognized UL 60950
GL approvals	GL applied for

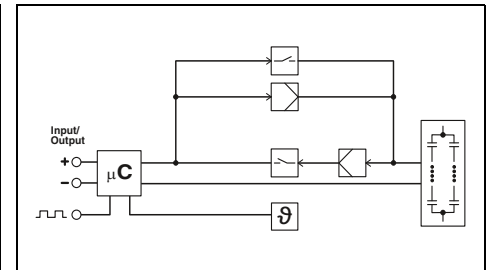

#### Technical data

Input data	
Nominal input voltage	24 V DC
DC input voltage range	18 V DC ... 30 V DC
Nominal capacity	20 kJ
Output data	
Nominal output voltage	24 V DC
Output voltage range	22 V DC ... 27 V DC
Output current	20 A
Output fuse	2x 25 A (internal)
Can be connected in parallel / series	Yes / No
Buffer period	12 min (1 A) / 33 s (20 A)
General data	
Storage medium	Dual layer capacitor
Weight / Dimensions W x H x D	2.9 kg / 150 x 130 x 176 mm
Degree of protection / Protection class	IP20 / III
Ambient temperature (operation)	-40 °C ... 60 °C
Ambient temperature (storage/transport)	-40 °C ... 60 °C
Service life	20 Years (20°C)
Standards/regulations	
UL approvals	UL Listed UL 508 , UL/C-UL Recognized UL 60950
GL approvals	GL applied for

#### Ordering data

Description	Type	Order No.	Pcs. / Pkt.
Power storage device	UPS-CAP/24DC/10A/10KJ	2320377	1

#### Ordering data

Description	Type	Order No.	Pcs. / Pkt.
Power storage device	UPS-CAP/24DC/20A/20KJ	2320380	1



**Power storage device for QUINT UPS-IQ**

**UPS-BAT/LI-ION for long service life with long buffer times**

- Lithium-ion technology
- Works reliably, even under extreme ambient temperatures of -20 to +58°C
- Communication with QUINT UPS-IQ
- Integrated temperature sensor for optimum charging
- Battery can be changed without tools



120 Wh

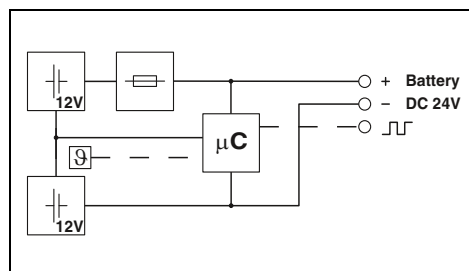

Input data/output data	
Nominal voltage	24 V DC
Nominal capacity	120 Wh
Output current	30 A
Output fuse	1x 30 A
Can be connected in parallel / series	Yes / No
Buffer period	14 min (20 A)
General data	
Storage medium	LI-ION, 120 Wh
Weight / Dimensions W x H x D	2,9 kg / 135 x 202 x 110 mm
Degree of protection / Protection class	IP20 / III
Ambient temperature (operation)	-20 °C ... 58 °C
Service life	15 Years (20°C)
Standards/regulations	
UL approvals	UL/C-UL listed UL 508 , UL/C-UL Recognized UL 60950

**Technical data**

Ordering data		
Type	Order No.	Pcs. / Pkt.
UPS-BAT/LI-ION/24DC/120WH	2320351	1

Description
<b>Power storage device</b>

Ordering data		
Type	Order No.	Pcs. / Pkt.
UPS-BAT/LI-ION/24DC/120WH	2320351	1

# Power supply units and UPS

## Uninterruptible power supply units for the control cabinet

### Power storage device for QUINT UPS-IQ

#### UPS BAT/VRLA for maximum buffer times

- Lead AGM (Absorbent Glass Mat) technology
- Ambient temperatures from 0 to +40°C
- Long buffer times for high currents
- Communication with QUINT UPS-IQ
- Integrated temperature sensor for optimum charging
- Battery can be changed without tools



1.3 Ah



3.4 Ah



Ex:

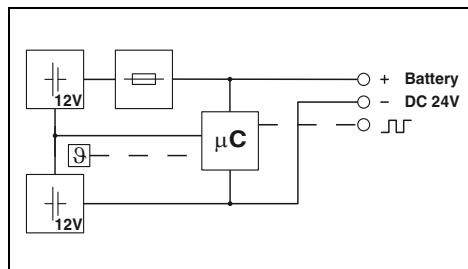

Technical data



Ex:

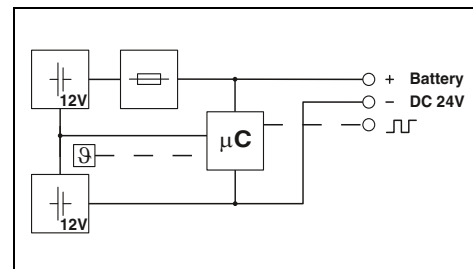

Technical data

Input data/output data	
Nominal voltage	24 V DC
Nominal capacity	1.3 Ah
Output current	15 A
Output fuse	1x 15 A
Can be connected in parallel / series	Yes / No
Buffer period	20 min (2 A) / 5 min (5 A)
General data	
Storage medium	Lead rechargeable battery module
Weight / Dimensions W x H x D	1.7 kg / 54 x 157 x 113 mm
Degree of protection / Protection class	IP20 / III
Ambient temperature (operation)	0 °C ... 40 °C
Service life	6 Years ... 9 Years (20°C)
Standards/regulations	
UL approvals	UL/C-UL listed UL 508 , UL/C-UL Recognized UL 60950 , UL/C-UL Recognized UL 1778 , UL ANSI/ISA-12.12.01 Class I, Division 2, Groups A, B, C, D (Hazardous Location)

Technical data	
Nominal voltage	24 V DC
Nominal capacity	3.4 Ah
Output current	25 A
Output fuse	1x 25 A
Can be connected in parallel / series	Yes / No
Buffer period	4.5 min (20 A) / 3 min (25 A)
General data	
Storage medium	Lead rechargeable battery module
Weight / Dimensions W x H x D	3.3 kg / 85 x 191 x 110 mm
Degree of protection / Protection class	IP20 / III
Ambient temperature (operation)	0 °C ... 40 °C
Service life	6 Years ... 9 Years (20°C)
Standards/regulations	
UL approvals	UL/C-UL listed UL 508 , UL/C-UL Recognized UL 60950 , UL/C-UL Recognized UL 1778 , UL ANSI/ISA-12.12.01 Class I, Division 2, Groups A, B, C, D (Hazardous Location)

Ordering data	
Description	Type
	Order No.
Power storage device	UPS-BAT/VRLA/24DC/ 1.3AH

Ordering data	
Type	Pcs. / Pkt.
	Order No.
UPS-BAT/VRLA/24DC/ 1.3AH	2320296
	1

Accessories	
Mounting set	

Accessories	
Mounting set	

Ordering data	
Type	Pcs. / Pkt.
	Order No.
UPS-BAT/VRLA/24DC/ 3.4AH	2320306
	1

Ordering data	
Type	Pcs. / Pkt.
	Order No.
UPS-BAT/VRLA/24DC/ 3.4AH	2320306
	1

Accessories	
Mounting set	

Uninterruptible power supply units for the control cabinet



7.2 Ah



12 Ah

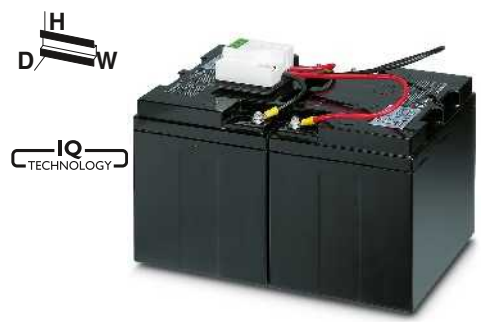

38 Ah

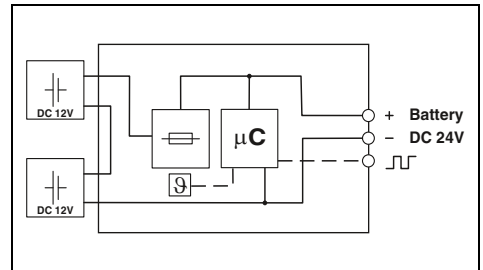
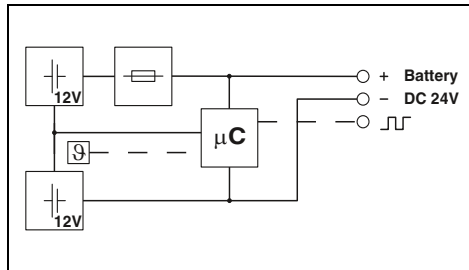
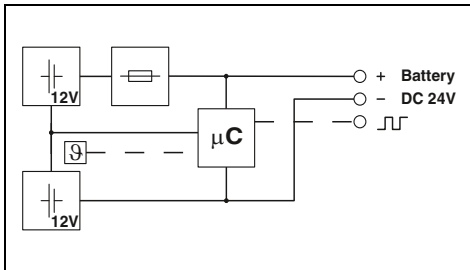

Technical data

24 V DC  
7.2 Ah  
50 A  
2x 25 A  
Yes / No  
10 min (20 A) / 3 min (40 A)

Lead rechargeable battery module  
5.9 kg / 135 x 202 x 110 mm  
IP20 / III  
0 °C ... 40 °C  
6 Years ... 9 Years (20°C)

UL/C-UL listed UL 508 , UL/C-UL Recognized UL 60950 , UL/C-UL Recognized UL 1778 , UL ANSI/ISA-12.12.01 Class I, Division 2, Groups A, B, C, D (Hazardous Location)

Technical data

24 V DC  
12 Ah  
50 A  
2x 25 A  
Yes / No  
22.5 min (20 A) / 9 min (40 A)

Lead rechargeable battery module  
8.9 kg / 202 x 202 x 110 mm  
IP20 / III  
0 °C ... 40 °C  
6 Years ... 9 Years (20°C)

UL/C-UL listed UL 508 , UL/C-UL Recognized UL 60950 , UL/C-UL Recognized UL 1778 , UL ANSI/ISA-12.12.01 Class I, Division 2, Groups A, B, C, D (Hazardous Location)

Technical data

24 V DC  
38 Ah  
50 A  
2x 25 A  
Yes / No  
72 min (20 A) / 35 min (40 A)

Lead rechargeable battery module  
26 kg / 330 x 210 x 197 mm  
IP20 / III  
0 °C ... 40 °C  
10 Years ... 12 Years (20°C)

UL/C-UL listed UL 508 , UL/C-UL Recognized UL 60950 , UL/C-UL Recognized UL 1778

Ordering data

Type	Order No.	Pcs. / Pkt.
UPS-BAT/VRLA/24DC/ 7.2AH	2320319	1

Accessories

Ordering data

Type	Order No.	Pcs. / Pkt.
UPS-BAT/VRLA/24DC/12AH	2320322	1

Accessories

Ordering data

Type	Order No.	Pcs. / Pkt.
UPS-BAT/VRLA/24DC/38AH	2320335	1

Accessories

BATTERY MOUNTING KIT	2320788	1
----------------------	---------	---

# Power supply units and UPS

## Uninterruptible power supply units for the control cabinet

### Power storage device for QUINT UPS-IQ

#### BAT/VRLA-WTR UPS for temperatures from -40°C to +60°C

- Pure lead AGM technology
- Communication with QUINT UPS-IQ
- Integrated temperature sensor for optimum charging



Power storage device with wide temperature range  
24 V DC, 13 Ah

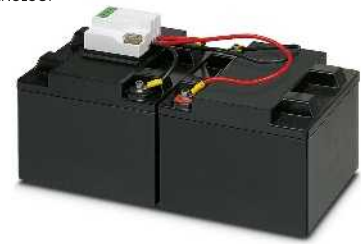

Power storage device with wide temperature range  
24 V DC, 26 Ah

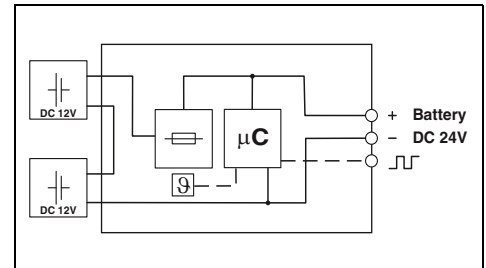
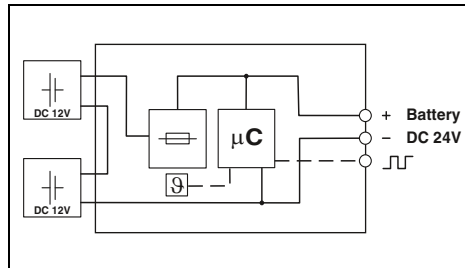

#### Technical data

Input data/output data	
Nominal voltage	24 V DC
Nominal capacity	13 Ah
Output current	50 A
Output fuse	2x 25 A
Can be connected in parallel / series	Yes / No
Buffer period	50 min (10 A) / 10 min (40 A)
General data	
Storage medium	Pure lead AGM
Weight / Dimensions W x H x D	10.8 kg / 178 x 168 x 172 mm
Degree of protection / Protection class	IP20 / III
Ambient temperature (operation)	-40 °C ... 60 °C
Ambient temperature (storage/transport)	-40 °C ... 60 °C
Service life	10 Years ... 15 Years (20°C)
Standards/regulations	
UL approvals	UL/C-UL listed UL 508 , UL/C-UL Recognized UL 60950
GL approvals	GL applied for

#### Technical data

Input data/output data	
Nominal voltage	24 V DC
Nominal capacity	26 Ah
Output current	50 A
Output fuse	2x 25 A
Can be connected in parallel / series	Yes / No
Buffer period	120 min (10 A) / 30 min (40 A)
General data	
Storage medium	Pure lead AGM
Weight / Dimensions W x H x D	21.6 kg / 358 x 165 x 169 mm
Degree of protection / Protection class	IP20 / III
Ambient temperature (operation)	-40 °C ... 60 °C
Ambient temperature (storage/transport)	-40 °C ... 60 °C
Service life	10 Years ... 15 Years (20°C)
Standards/regulations	
UL approvals	UL/C-UL listed UL 508 , UL/C-UL Recognized UL 60950
GL approvals	GL applied for

#### Ordering data

Description	Type	Order No.	Pcs. / Pkt.
Power storage device	UPS-BAT/VRLA-WTR/24DC/13AH	2320416	1

#### Ordering data

Description	Type	Order No.	Pcs. / Pkt.
Power storage device	UPS-BAT/VRLA-WTR/24DC/26AH	2320429	1

#### Accessories

Mounting set	BATTERY MOUNTING KIT	2320788	1
--------------	----------------------	---------	---

#### Accessories

Mounting set	BATTERY MOUNTING KIT	2320788	1
--------------	----------------------	---------	---



# Power supply units and UPS

## Uninterruptible power supply units for the control cabinet

### Configuration software for QUINT UPS-IQ

The UPS CONF configuration software can be downloaded free of charge from our homepage. Remember to order the IFS-USB-DATACABLE as well in order to use the software.

#### Supported operating systems:

- Windows 7 (32 and 64-bit)
- Windows Vista
- Windows XP

#### Minimum requirements:

- Display: 800 x 600, 256 colors
- Processor: 400 MHz, Pentium processor or similar
- RAM: 96 MB



Description	Ordering data		
	Type	Order No.	Pcs. / Pkt.
Configuration software for QUINT UPS IQ	UPS-CONF	2320403	1

### Accessories for QUINT UPS-IQ and TRIO UPS

IFS-USB-DATACABLE is required for communication between the uninterruptible power supply and the UPS CONF configuration software.

IFS-CONFSTICK for storing the values you have configured and transferring them to other uninterruptible power supplies.



**Notes:**  
1) EMC: Class A product, see page 287

Description	Ordering data			Ordering data		
	Type	Order No.	Pcs. / Pkt.	Type	Order No.	Pcs. / Pkt.
Used for communication between the UPS CONF configuration software and the QUINT UPS IQ or TRIO UPS uninterruptible power supply	IFS-USB-DATACABLE	2320500	1	IFS-CONFSTICK <sup>1)</sup>	2986122	1
Cable length: 3 m				IFS-CONFSTICK-L	2901103	1
<b>Multi-functional memory block</b> for the INTERFACE system						
- Flat design						
- Tall design						

Accessories for QUINT UPS-IQ

**IFS-RS232-DATACABLE**

- For Modbus communication with the RS-232 interface
- Connection to the Phoenix Contact COM server for Ethernet communication
- Communicate directly with higher-level controllers, such as Phoenix Contact ILC or RFC, or use as a gateway



**IFS-MINI-DIN-DATACABLE**

- For direct communication with the ILC from the Phoenix Contact Inline system

**IFS-OPEN-END-DATACABLE**

- Open cable for flexible communication

**QUINT UPS-IQ function blocks**

- For further processing of information communicated via data cables
- For PC Worx software
- Free download at [www.phoenixcontact.net/products](http://www.phoenixcontact.net/products)

Description
<b>Data cable</b> for communication between higher-level controllers and QUINT UPS-IQ uninterruptible power supply units, cable length: 2 m
Modbus communication
Direct communication
Flexible communication

Ordering data		
Type	Order No.	Pcs. / Pkt.
IFS-RS232-DATACABLE	2320490	1
IFS-MINI-DIN-DATACABLE	2320487	1
IFS-OPEN-END-DATACABLE	2320450	1

**Mounting set**

- For attaching individual battery blocks to a mounting plate
- Consists of four powder-coated metal brackets and a fabric lashing strap



Description
<b>Mounting set</b>

Ordering data		
Type	Order No.	Pcs. / Pkt.
BATTERY MOUNTING KIT	2320788	1

# Power supply units and UPS

## Uninterruptible power supply units for the control cabinet

### UPS module with integrated power storage

QUINT-UPS is very easy to install in existing systems. It's just a case of connecting a 24 V DC power supply unit upstream and the reliable UPS solution is complete.

- Advantages of using IQ technology
- Minimal wiring effort
- Maintenance-free power storage device with lead AGM technology

**Notes:**  
The buffer time associated with your solution is dependent on the load current. Exact details for each uninterruptible power supply can be found on page 233



**Uninterruptible power supply with integrated power storage, 24 V DC / 24 V DC, 5 A, 1.3 Ah**



**Uninterruptible power supply with integrated power storage, 24 V DC / 24 V DC, 10 A, 3.4 Ah**

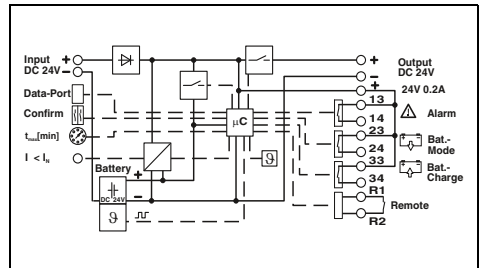
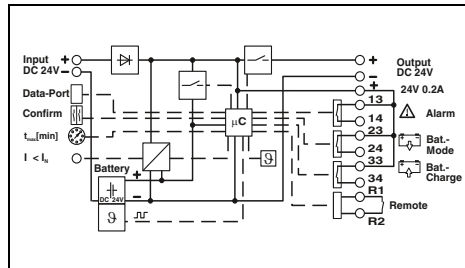

#### Technical data

Input data	
Nominal input voltage	24 V DC
DC input voltage range	18 V DC ... 30 V DC
Max. current consumption	9.3 A (24 V DC)
Output data	
Nominal output voltage	24 V DC
Output voltage range	19.2 V DC ... 27.6 V DC ( $U_{OUT} = U_{BAT} - 0.5 V DC$ )
Output current	
Can be connected in parallel / series	5 A
Buffer period	Yes / No
Max. power dissipation (normal mode / buffer mode)	50 min (1 A) / 5 min (5 A) 2.5 W / 3.3 W
Efficiency (typ.)	> 97.1 % (with charged power storage device)
Signaling	
Signaling	LED, relay contact, interface/software
Interfaces	IFS (Interface system data port)
General data	
Storage medium	Lead rechargeable battery module 1.3 Ah
Weight / Dimensions W x H x D	2.2 kg / 88 x 138 x 125 mm
Installation position	horizontal DIN rail NS 35, EN 60715
Spacing when mounting	Can be aligned: horizontal 5 mm, vertical 50 mm
Connection method	Plug-in screw connection
Input connection data (solid/stranded/AWG)	0.2 - 2.5 mm <sup>2</sup> / 0.2 - 2.5 mm <sup>2</sup> / 20 - 12
Output connection data (solid/stranded/AWG)	0.2 - 2.5 mm <sup>2</sup> / 0.2 - 2.5 mm <sup>2</sup> / 20 - 12
Signal connection data (solid/stranded/AWG)	0.2 - 2.5 mm <sup>2</sup> / 0.2 - 2.5 mm <sup>2</sup> / 24 - 12
Degree of protection / Protection class	IP20 / III
MTBF (EN 29500, 40°C)	> 806493 h
Ambient temperature (operation)	0 °C ... 40 °C
Ambient temperature (storage/transport)	-15 °C ... 40 °C
Service life	6 Years ... 9 Years (20°C)
Latest startup	9 Months (20 °C ... 30 °C) 6 Months (30 °C ... 40 °C)
Standards/regulations	
Electromagnetic compatibility	Conformance with EMC Directive 2004/108/EC
Electrical safety, safety transformer	EN 60950-1/VDE 0805 (SELV)
Electronic equipm. for electrical power installations	EN 50178/VDE 0160 (PELV)
UL approvals	UL/C-UL Recognized UL 60950 , UL Listed UL 508

#### Ordering data

Description	Type	Order No.	Pcs. / Pkt.
Power supply, uninterruptible	QUINT-UPS/ 24DC/ 24DC/ 5/1.3AH	2320254	1

#### Technical data

Input data	
Nominal input voltage	24 V DC
DC input voltage range	18 V DC ... 30 V DC
Max. current consumption	18.6 A (24 V DC)
Output data	
Nominal output voltage	24 V DC
Output voltage range	19.2 V DC ... 27.6 V DC ( $U_{OUT} = U_{BAT} - 0.5 V DC$ )
Output current	
Can be connected in parallel / series	10 A
Buffer period	Yes / No
Max. power dissipation (normal mode / buffer mode)	180 min (1 A) / 10 min (10 A) 3.1 W / 6.3 W
Efficiency (typ.)	> 97.6 % (with charged power storage device)
Signaling	
Signaling	LED, relay contact, interface/software
Interfaces	IFS (Interface system data port)
General data	
Storage medium	Lead rechargeable battery module, 3.4 Ah
Weight / Dimensions W x H x D	3.8 kg / 120 x 169 x 125 mm
Installation position	horizontal DIN rail NS 35, EN 60715
Spacing when mounting	Can be aligned: horizontal 5 mm, vertical 50 mm
Connection method	Plug-in screw connection
Input connection data (solid/stranded/AWG)	0.2 - 2.5 mm <sup>2</sup> / 0.2 - 2.5 mm <sup>2</sup> / 16 - 12
Output connection data (solid/stranded/AWG)	0.2 - 2.5 mm <sup>2</sup> / 0.2 - 2.5 mm <sup>2</sup> / 16 - 12
Signal connection data (solid/stranded/AWG)	0.2 - 2.5 mm <sup>2</sup> / 0.2 - 2.5 mm <sup>2</sup> / 24 - 12
Degree of protection / Protection class	IP20 / III
MTBF (EN 29500, 40°C)	> 806493 h
Ambient temperature (operation)	0 °C ... 40 °C
Ambient temperature (storage/transport)	-15 °C ... 40 °C
Service life	6 Years ... 9 Years (20°C)
Latest startup	9 Months (20 °C ... 30 °C) 6 Months (30 °C ... 40 °C)
Standards/regulations	
Electromagnetic compatibility	Conformance with EMC Directive 2004/108/EC
Electrical safety, safety transformer	EN 60950-1/VDE 0805 (SELV)
Electronic equipm. for electrical power installations	EN 50178/VDE 0160 (PELV)
UL approvals	UL/C-UL Recognized UL 60950 , UL Listed UL 508

#### Ordering data

Description	Type	Order No.	Pcs. / Pkt.
Power supply, uninterruptible	QUINT-UPS/ 24DC/ 24DC/10/3.4AH	2320267	1



**Maintenance-free buffer module**

The buffer module can accommodate failures lasting several seconds.

It combines an electronic switch-over unit and a capacitor-based power storage device in the same housing.

**Notes:**  
The buffer time associated with your solution is dependent on the load current. Exact details for each uninterruptible power supply can be found on page 233



**Buffer module,  
24 V DC / 24 V DC, 40 A**

UL, CE, RoHS  
Ex: RoHS

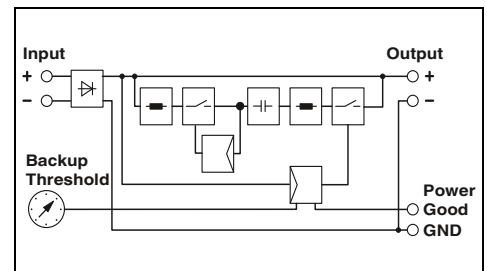

**Technical data**

<b>Input data</b>	24 V DC 18 V DC ... 30 V DC 0.1 A / 0.7 A / 44.7 A < 20 V DC (< 22 V; < 24 V; < 26 V) , (U <sub>IN</sub> - 1 V)/0.1 s
<b>Output data</b>	24 V DC (depending on the input voltage) 40 A Yes / No 0.2 s (40 A) / 8 s (1 A) 8 W / 48 W
<b>Efficiency (typ.)</b>	> 99 % (with charged power storage device)
<b>Signaling</b>	LED, active switching output
<b>General data</b>	Electrolytic capacitor 1.1 kg / 64 x 130 x 125 mm horizontal DIN rail NS 35, EN 60715 Can be aligned: Horizontally 0 mm, vertically 50 mm Screw connection 0.5 - 16 mm <sup>2</sup> / 0.5 - 16 mm <sup>2</sup> / 8 - 6 0.5 - 16 mm <sup>2</sup> / 0.5 - 16 mm <sup>2</sup> / 8 - 6 0.2 - 4 mm <sup>2</sup> / 0.2 - 2.5 mm <sup>2</sup> / 24 - 12 IP20 / III > 902725 h -25 °C ... 80 °C
<b>Standards/regulations</b>	500 V Conformance with EMC Directive 2004/108/EC EN 60950-1/VDE 0805 (SELV) EN 50178/VDE 0160 (PELV) UL/C-UL Recognized UL 60950 , UL Listed UL 508

**Ordering data**

Description	Type	Order No.	Pcs. / Pkt.
<b>Power supply, uninterruptible</b>	QUINT-BUFFER/24DC/24DC/40	2320393	1

# Power supply units and UPS

## Uninterruptible power supply units for the control cabinet

### UPS module with integrated power storage

– Uninterruptible power supply with integrated power storage device

#### STEP UPS

The STEP BAT power supply unit is included as part of the STEP UPS order. The STEP BAT can be reordered separately. (See accessories on this page)

**Notes:**  
With the STEP-UPS/12DC/12DC/4, buffer times are double those of the STEP-UPS/24DC/24 DC/3. See page 233



Uninterruptible power supply with integrated rechargeable battery, 24 V DC / 24 V DC, 3 A

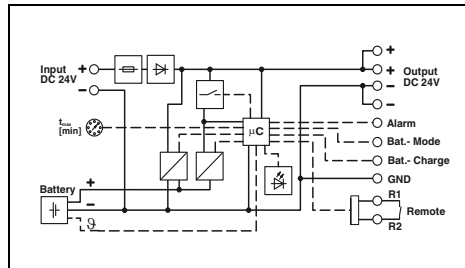

#### Technical data

Input data	
Nominal input voltage	24 V DC
DC input voltage range	22.5 V DC ... 29.5 V DC
Max. current consumption	4.1 A (24 V DC)
Current consumption charging process	4.7 A
Input fuse	7 A (slow-blow, internal)
Output data	
Nominal output voltage	24 V DC
Output current standard operation	3 A
Output current POWER BOOST	4 A (0°C ... 35°C)
Can be connected in parallel / series	No / No
Buffer period	50 min (1 A) / 25 min (2 A)
Max. power dissipation (normal mode / buffer mode)	2.7 W / 4.4 W
Efficiency (typ.)	> 98 % (Mains operation, with charged power storage)

Signaling	
Signaling Power OK	LED
Signaling alarm	LED, active transistor switching output
Signaling battery charge	LED, active transistor switching output
Signaling battery mode	LED, active transistor switching output
General data	
Storage medium	Lithium polymer
Weight / Dimensions W x H x D	0.45 kg / 108 x 90 x 61 mm
Installation position	horizontal DIN rail NS 35, EN 60715
Spacing when mounting	Can be aligned: Horizontally 0 mm, vertically 50 mm
Connection method	Screw connection
Input connection data (solid/stranded/AWG)	0.2 - 2.5 mm <sup>2</sup> / 0.2 - 2.5 mm <sup>2</sup> / 24 - 12
Output connection data (solid/stranded/AWG)	0.2 - 2.5 mm <sup>2</sup> / 0.2 - 2.5 mm <sup>2</sup> / 24 - 12
Signal connection data (solid/stranded/AWG)	0.2 - 2.5 mm <sup>2</sup> / 0.2 - 2.5 mm <sup>2</sup> / 24 - 12
Degree of protection / Protection class	IP20 / III
MTBF (EN 29500, 40°C)	> 1401000 h
Ambient temperature (operation)	0 °C ... 40 °C
Standards/regulations	
Electromagnetic compatibility	Conformance with EMC Directive 2004/108/EC
Electrical safety, safety transformer	EN 60950-1/VDE 0805 (SELV)
Electronic equipm. for electrical power installations	EN 50178/VDE 0160 (PELV)
UL approvals	UL Listed UL 508 , UL/C-UL Recognized UL 60950

#### Ordering data

Description	Type	Order No.	Pcs. / Pkt.
Power supply, uninterruptible	STEP-UPS/24DC/24DC/3	2868703	1

#### Accessories

Power storage device	STEP-BAT/LIPO/18.5DC/1.4AH	2320364	1
----------------------	----------------------------	---------	---

N



Uninterruptible power supply with integrated rechargeable battery, 12 V DC / 12 V DC, 4 A

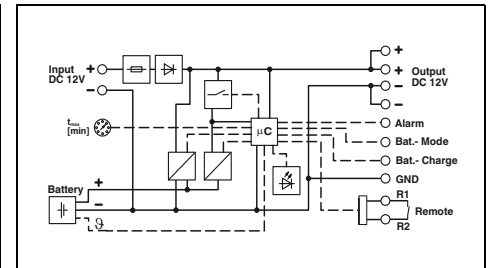

#### Technical data

Input data	
Nominal input voltage	12 V DC
DC input voltage range	10 V DC ... 16.5 V DC
Max. current consumption	5.7 A (12 V DC)
Current consumption charging process	6 A
Input fuse	7 A (slow-blow, internal)
Output data	
Nominal output voltage	12 V DC
Output current standard operation	4 A
Output current POWER BOOST	5 A (0°C ... 35°C)
Can be connected in parallel / series	No / No
Buffer period	100 min (1 A) / 50 min (2 A)
Max. power dissipation (normal mode / buffer mode)	2 W / 3.4 W
Efficiency (typ.)	> 97.4 % (Mains operation, with charged power storage)

Signaling	
Signaling Power OK	LED
Signaling alarm	LED, active transistor switching output
Signaling battery charge	LED, active transistor switching output
Signaling battery mode	LED, active transistor switching output
General data	
Storage medium	Lithium polymer
Weight / Dimensions W x H x D	0.46 kg / 108 x 90 x 61 mm
Installation position	horizontal DIN rail NS 35, EN 60715
Spacing when mounting	Can be aligned: Horizontally 0 mm, vertically 50 mm
Connection method	Screw connection
Input connection data (solid/stranded/AWG)	0.2 - 2.5 mm <sup>2</sup> / 0.2 - 2.5 mm <sup>2</sup> / 24 - 12
Output connection data (solid/stranded/AWG)	0.2 - 2.5 mm <sup>2</sup> / 0.2 - 2.5 mm <sup>2</sup> / 24 - 12
Signal connection data (solid/stranded/AWG)	0.2 - 2.5 mm <sup>2</sup> / 0.2 - 2.5 mm <sup>2</sup> / 24 - 12
Degree of protection / Protection class	IP20 / III
MTBF (EN 29500, 40°C)	> 1997000 h
Ambient temperature (operation)	0 °C ... 40 °C
Standards/regulations	
Electromagnetic compatibility	Conformance with EMC Directive 2004/108/EC
Electrical safety, safety transformer	EN 60950-1/VDE 0805 (SELV)
Electronic equipm. for electrical power installations	EN 50178/VDE 0160 (PELV)
UL approvals	UL Listed UL 508 , UL/C-UL Recognized UL 60950

#### Ordering data

Description	Type	Order No.	Pcs. / Pkt.
Power supply, uninterruptible	STEP-UPS/12DC/12DC/4	2868693	1

#### Accessories

Power storage device	STEP-BAT/LIPO/18.5DC/1.4AH	2320364	1
----------------------	----------------------------	---------	---



# Power supply units and UPS

## Uninterruptible power supply units for the control cabinet

### UPS module with integrated power supply unit

#### TRIO UPS

Developed specifically for supplying industrial PCs. Configuration port: freely parameterizable with the UPS CONF configuration software. Configuration stick: parameterize stick once and transfer to any number of TRIO UPS units.

The UPS-CONF TRIO (Order No.: 2320348) configuration software can be downloaded free of charge from our homepage.



UPS with integrated power supply,  
100 - 240 V AC / 24 V DC, 5 A

#### Notes:

The buffer time associated with your solution is dependent on the load current. Exact details for each uninterruptible power supply can be found on page 233

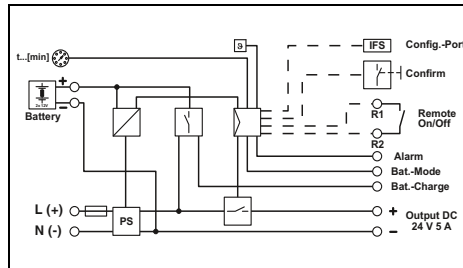

#### Technical data

Input data	
Nominal input voltage range	100 V AC ... 240 V AC
Input voltage range AC/DC	85 V AC ... 264 V AC / 100 V DC ... 350 V DC
Max. current consumption in normal mode	0.95 A / 1.1 A (230 V AC) , 1.7 A / 1.8 A (120 V AC)
Input fuse	6.3 A (slow-blow, internal)
Reliable backup fuse, circuit breaker	B6 , B10 , B16
Output data	
Nominal output voltage	24 V DC
Output current	5 A
Can be connected in parallel / series	No / No
Buffer period	20 min (5 A)
Max. power dissipation (normal mode / buffer mode)	16 W / 4 W
Efficiency (typ.)	> 88 % (230 V AC, network operation)
Signaling	
Interfaces	IFS (Interface system data port)
Signaling Power OK	LED
Signaling alarm	LED, active switching output
Signaling battery charge	LED, active switching output
Signaling battery mode	LED, active switching output
General data	
Storage medium	External, battery 1.3 Ah / 3.4 Ah / 7.2 Ah / 12 Ah
Weight / Dimensions W x H x D	1.1 kg / 60 x 130 x 118 mm
Installation position	horizontal DIN rail NS 35, EN 60715
Spacing when mounting	Can be aligned: Horizontally 0 mm, vertically 50 mm
Connection method	Screw connection
Input connection data (solid/stranded/AWG)	0.2 - 2.5 mm <sup>2</sup> / 0.2 - 2.5 mm <sup>2</sup> / 24 - 12
Output connection data (solid/stranded/AWG)	0.2 - 2.5 mm <sup>2</sup> / 0.2 - 2.5 mm <sup>2</sup> / 24 - 12
Signal connection data (solid/stranded/AWG)	0.2 - 2.5 mm <sup>2</sup> / 0.2 - 2.5 mm <sup>2</sup> / 24 - 12
Degree of protection / Protection class	IP20 / I
MTBF (EN 29500, 40°C)	> 596285 h
Ambient temperature (operation)	-25 °C ... 70 °C (> 55 °C derating)
Standards/regulations	
Insulation voltage input/output	2 kV (Routine test) / 4 kV (type test)
Electromagnetic compatibility	Conformance with EMC Directive 2004/108/EC
Electrical safety, safety transformer	EN 60950-1/VDE 0805 (SELV)
Electronic equipm. for electrical power installations	EN 50178/VDE 0160 (PELV)
UL approvals	UL/C-UL listed UL 508 , UL/C-UL Recognized UL 60950

#### Ordering data

Description	Type	Order No.	Pcs. / Pkt.
Power supply, uninterruptible	TRIO-UPS/1AC/24DC/ 5	2866611	1

Uninterruptible power supply units for the control cabinet

UPS module with integrated power supply unit

MINI-UPS 24 V DC and 12 V DC

The MINI UPS combines the power supply unit and the UPS module in the same housing in a particularly space-saving way.

**Notes:**  
 With the MINI-DC-UPS/12DC/4, buffer times are double those of the MINI-DC-UPS/24DC/2.  
 The buffer time associated with your solution is dependent on the load current. Exact details for each uninterruptible power supply can be found on page 233



UPS with integrated power supply, 100 - 240 V AC / 24 V DC, 2 A

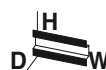

UPS with integrated power supply, 100 - 240 V AC / 12 V DC, 4 A

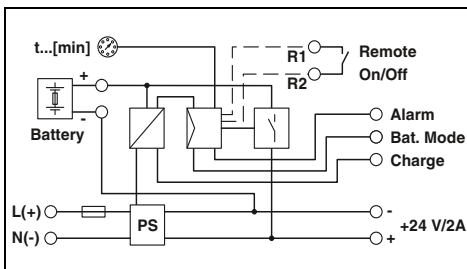

Technical data

Input data	
Nominal input voltage range	100 V AC ... 240 V AC
Input voltage range AC/DC	85 V AC ... 264 V AC / 100 V DC ... 350 V DC
Max. current consumption in normal mode	0.6 A / 0.85 A (230 V AC) , 1.1 A / 1.5 A (120 V AC)
Input fuse	3.15 A (slow-blow, internal)
Reliable backup fuse, circuit breaker	B6 , B10 , B16
Output data	
Nominal output voltage	24 V DC (AC input voltage available: 22.5 to 29.5 V DC, AC input voltage not available: 27.9 to 19.2 V DC)
Output current	2 A
Can be connected in parallel / series	No / Yes
Buffer period	20 min (2 A)
Max. power dissipation (idling / normal mode / buffer mode)	3.8 W / 10.1 W / 2.1 W
Efficiency (typ.)	> 83 %
Signaling	
Signaling Power OK	LED
Signaling alarm	LED, active switching output
Signaling battery charge	LED, active switching output
Signaling battery mode	LED, active switching output
General data	
Storage medium	External, battery 0.8 Ah / 1.3 Ah
Weight / Dimensions W x H x D	0.45 kg / 67.5 x 99 x 107 mm
Installation position	horizontal DIN rail NS 35, EN 60715
Spacing when mounting	Can be aligned: Horizontally 0 mm, vertically 50 mm
Connection method	Plug-in COMBICON screw connections
Input connection data (solid/stranded/AWG)	0.2 - 2.5 mm <sup>2</sup> / 0.2 - 2.5 mm <sup>2</sup> / 24 - 12
Output connection data (solid/stranded/AWG)	0.2 - 2.5 mm <sup>2</sup> / 0.2 - 2.5 mm <sup>2</sup> / 24 - 12
Signal connection data (solid/stranded/AWG)	0.2 - 2.5 mm <sup>2</sup> / 0.2 - 2.5 mm <sup>2</sup> / 24 - 12
Degree of protection / Protection class	IP20 / II (in an enclosed control cabinet)
MTBF (EN 29500, 40°C)	> 728579 h
Ambient temperature (operation)	-25 °C ... 70 °C (> 60 °C derating)
Standards/regulations	
Insulation voltage input/output	2 kV (routine test) / 4 kV (type test)
Electromagnetic compatibility	Conformance with EMC Directive 2004/108/EC
Electrical safety, safety transformer	EN 60950-1/VDE 0805 (SELV)
Electronic equipm. for electrical power installations	EN 50178/VDE 0160 (PELV)
UL approvals	UL Listed UL 508 , UL/C-UL Recognized UL 60950 , UL ANSI/ISA-12.12.01 Class I, Division 2, Groups A, B, C, D (Hazardous Location)

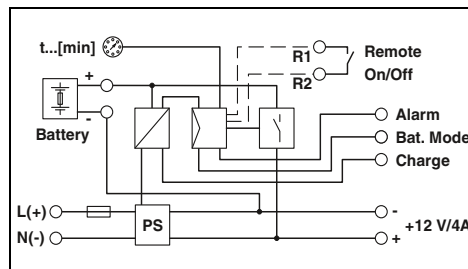

Technical data

Input data	
Nominal input voltage range	100 V AC ... 240 V AC
Input voltage range AC/DC	85 V AC ... 264 V AC / 100 V DC ... 350 V DC
Max. current consumption in normal mode	0.5 A / 0.65 A (230 V AC) , 1.15 A / 1.35 A (120 V AC)
Input fuse	3.15 A (slow-blow, internal)
Reliable backup fuse, circuit breaker	B6 , B10 , B16
Output data	
Nominal output voltage	12 V DC (AC input voltage available: 10 to 16 V DC, AC input voltage not available: 13.6 to 9.6 V DC)
Output current	4 A
Can be connected in parallel / series	No / Yes
Buffer period	20 min (4 A)
Max. power dissipation (idling / normal mode / buffer mode)	1.6 W / 10.5 W / 2.6 W
Efficiency (typ.)	> 82 %
Signaling	
Signaling Power OK	LED
Signaling alarm	LED, active switching output
Signaling battery charge	LED, active switching output
Signaling battery mode	LED, active switching output
General data	
Storage medium	External, rechargeable battery 1.6 Ah / 2.6 Ah
Weight / Dimensions W x H x D	0.45 kg / 67.5 x 99 x 107 mm
Installation position	horizontal DIN rail NS 35, EN 60715
Spacing when mounting	Can be aligned: Horizontally 0 mm, vertically 50 mm
Connection method	Plug-in COMBICON screw connections
Input connection data (solid/stranded/AWG)	0.2 - 2.5 mm <sup>2</sup> / 0.2 - 2.5 mm <sup>2</sup> / 24 - 12
Output connection data (solid/stranded/AWG)	0.2 - 2.5 mm <sup>2</sup> / 0.2 - 2.5 mm <sup>2</sup> / 24 - 12
Signal connection data (solid/stranded/AWG)	0.2 - 2.5 mm <sup>2</sup> / 0.2 - 2.5 mm <sup>2</sup> / 24 - 12
Degree of protection / Protection class	IP20 / II (in an enclosed control cabinet)
MTBF (EN 29500, 40°C)	> 753179 h
Ambient temperature (operation)	-25 °C ... 70 °C (> 60 °C derating)
Standards/regulations	
Insulation voltage input/output	2 kV (routine test) / 4 kV (type test)
Electromagnetic compatibility	Conformance with EMC Directive 2004/108/EC
Electrical safety, safety transformer	EN 60950-1/VDE 0805 (SELV)
Electronic equipm. for electrical power installations	EN 50178/VDE 0160 (PELV)
UL approvals	UL Listed UL 508 , UL/C-UL Recognized UL 60950 , UL ANSI/ISA-12.12.01 Class I, Division 2, Groups A, B, C, D (Hazardous Location)

Ordering data

Description	Type	Order No.	Pcs. / Pkt.
Power supply, uninterruptible	MINI-DC-UPS/24DC/2	2866640	1

Ordering data

Description	Type	Order No.	Pcs. / Pkt.
Power supply, uninterruptible	MINI-DC-UPS/12DC/4	2866598	1

# Power supply units and UPS

## Uninterruptible power supply units for the control cabinet

### Power storage device for TRIO UPS

#### MINI-BAT, QUINT-BAT

MINI-BAT and QUINT BAT for maximum buffer times

- Lead AGM (Absorbent Glass Mat) technology
- Ambient temperatures from 0 to +40°C



**Power storage, 24 V DC, 1.3 Ah for TRIO UPS and MINI UPS 2 A**

Ex: <sup>1</sup>

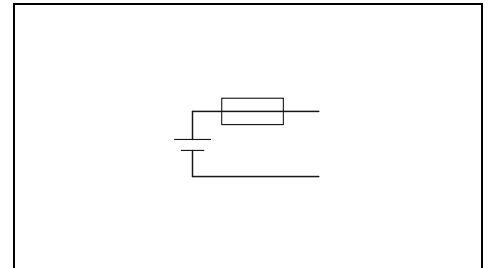

Input data/output data	
Nominal input voltage	24 V DC
Nominal capacity	1.3 Ah
Nominal output voltage	24 V DC
Output current	15 A
Can be connected in parallel / series	Yes / No
General data	
Weight / Dimensions W x H x D	1.7 kg / 52 x 130 x 110 mm
Degree of protection / Protection class	IP20 / III
Ambient temperature (operation)	0 °C ... 40 °C
Service life	6 Years ... 9 Years (20 °C)
Latest startup	9 Months (20 °C ... 30 °C) 6 Months (30 °C ... 40 °C)

Technical data		
24 V DC		
1.3 Ah		
24 V DC		
15 A		
Yes / No		
1.7 kg / 52 x 130 x 110 mm		
IP20 / III		
0 °C ... 40 °C		
6 Years ... 9 Years (20 °C)		
9 Months (20 °C ... 30 °C)		
6 Months (30 °C ... 40 °C)		

Description	
<b>Battery module</b>	

Ordering data		
Type	Order No.	Pcs. / Pkt.
MINI-BAT/24DC/1.3AH	2866417	1



Power storage, 24 V DC, 3.4 Ah  
for TRIO UPS



Power storage, 24 V DC, 7.2 Ah  
for TRIO UPS



Power storage, 24 V DC, 12 Ah  
for TRIO UPS

BSH

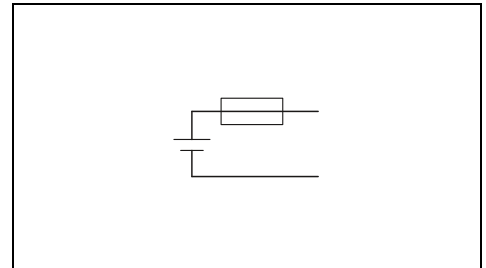
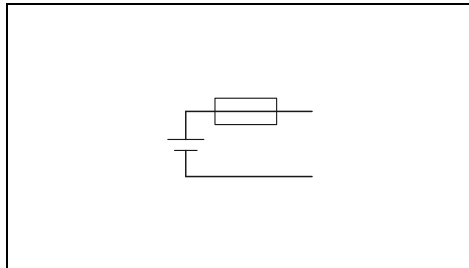
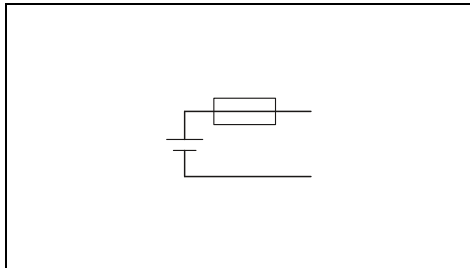

Technical data

24 V DC  
3.4 Ah  
24 V DC  
25 A  
Yes / No

3.5 kg / 112 x 145 x 123 mm  
IP20 / III  
0 °C ... 40 °C  
6 Years ... 9 Years (20 °C)  
9 Months (20 °C ... 30 °C)  
6 Months (30 °C ... 40 °C)

Technical data

24 V DC  
7.2 Ah  
24 V DC  
50 A  
Yes / No

6 kg / 164 x 156 x 110 mm  
IP20 / III  
0 °C ... 40 °C  
6 Years ... 9 Years (20 °C)  
9 Months (20 °C ... 30 °C)  
6 Months (30 °C ... 40 °C)

Technical data

24 V DC  
12 Ah  
24 V DC  
50 A  
Yes / No

9 kg / 231 x 156 x 110 mm  
IP20 / III  
0 °C ... 40 °C  
6 Years ... 9 Years (20 °C)  
9 Months (20 °C ... 30 °C)  
6 Months (30 °C ... 40 °C)

Ordering data

Type	Order No.	Pcs. / Pkt.
QUINT-BAT/24DC/ 3.4AH	2866349	1

Ordering data

Type	Order No.	Pcs. / Pkt.
QUINT-BAT/24DC/ 7.2AH	2866352	1

Ordering data

Type	Order No.	Pcs. / Pkt.
QUINT-BAT/24DC/12AH	2866365	1

# Power supply units and UPS

## Uninterruptible power supply units for the control cabinet

### Power storage device for MINI UPS

#### MINI-BAT

- MINI-BAT for maximum buffer times
- Lead AGM (Absorbent Glass Mat) technology
- Ambient temperatures from 0 to +40°C

**Notes:**

The buffer time associated with your solution is dependent on the load current. Exact details for each uninterruptible power supply can be found on page 233



**Power storage, 24 V DC, 0.8 Ah for MINI UPS 2 A**

Ex:

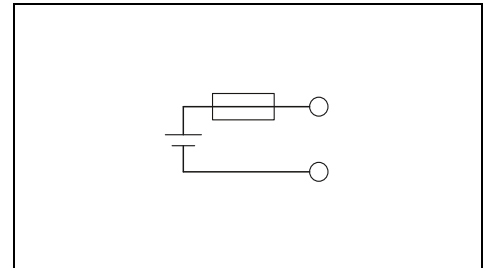

Input data/output data	
Nominal input voltage	24 V DC
Nominal capacity	0.8 Ah
Nominal output voltage	24 V DC
Output current	5 A
Can be connected in parallel / series	Yes / No
General data	
Weight / Dimensions W x H x D	0.9 kg / 67.5 x 99 x 107 mm
Degree of protection / Protection class	IP20 / III
Ambient temperature (operation)	0 °C ... 40 °C
Service life	4 Years (20 °C)
Latest startup	6 Months (20 °C ... 30 °C) 3 Months (30 °C ... 40 °C)

#### Technical data

Nominal input voltage	24 V DC
Nominal capacity	0.8 Ah
Nominal output voltage	24 V DC
Output current	5 A
Can be connected in parallel / series	Yes / No
General data	
Weight / Dimensions W x H x D	0.9 kg / 67.5 x 99 x 107 mm
Degree of protection / Protection class	IP20 / III
Ambient temperature (operation)	0 °C ... 40 °C
Service life	4 Years (20 °C)
Latest startup	6 Months (20 °C ... 30 °C) 3 Months (30 °C ... 40 °C)

Description
<b>Battery module</b>

#### Ordering data

Type	Order No.	Pcs. / Pkt.
MINI-BAT/24DC/0.8AH	2866666	1





Power storage, 24 V DC, 1.3 Ah for TRIO UPS and MINI UPS 2 A

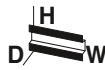

Power storage 12 V DC, 1.6 Ah for MINI UPS 4 A



Power storage 12 V DC, 2.6 Ah for MINI UPS 4 A

Ex:

Ex:

Ex:

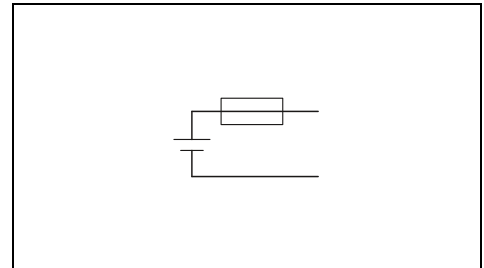
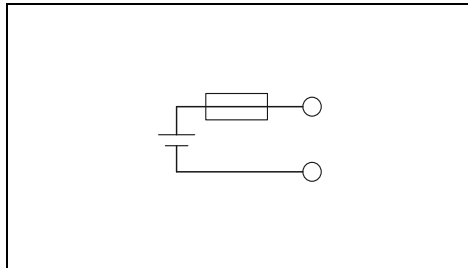
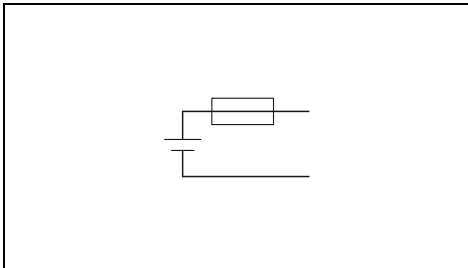

Technical data

24 V DC  
1.3 Ah  
24 V DC  
15 A  
Yes / No

1.7 kg / 52 x 130 x 110 mm  
IP20 / III  
0 °C ... 40 °C  
6 Years ... 9 Years (20 °C)  
9 Months (20 °C ... 30 °C)  
6 Months (30 °C ... 40 °C)

Technical data

12 V DC  
1.6 Ah  
12 V DC  
10 A  
Yes / No

0.9 kg / 67.5 x 99 x 107 mm  
IP20 / III  
0 °C ... 40 °C  
4 Years (20 °C)  
6 Months (20 °C ... 30 °C)  
3 Months (30 °C ... 40 °C)

Technical data

12 V DC  
2.6 Ah  
12 V DC  
15 A  
Yes / No

1.7 kg / 52 x 130 x 110 mm  
IP20 / III  
0 °C ... 40 °C  
6 Years ... 9 Years (20 °C)  
9 Months (20 °C ... 30 °C)  
6 Months (30 °C ... 40 °C)

Ordering data

Type	Order No.	Pcs. / Pkt.
MINI-BAT/24DC/1.3AH	2866417	1

Ordering data

Type	Order No.	Pcs. / Pkt.
MINI-BAT/12DC/1.6AH	2866572	1

Ordering data

Type	Order No.	Pcs. / Pkt.
MINI-BAT/12DC/2.6AH	2866569	1



### Constant power supply and improved power quality

UPS devices play an important role in ensuring reliable power quality. They bridge power failures and remove other mains faults such as:

- Under voltages or surge voltages
- High-frequency noise
- Frequency fluctuations
- Harmonics

### Class VFI-SS-111 UPS devices according to IEC 62040-3

The UPS devices are class VFI-SS-111 single-phase, uninterruptible power supply units. The connected loads are protected against any faults on the mains side. Double conversion technology permanently supplies loads with an output voltage/frequency that is independent of the mains input.

### Extensive configuration options:

Configure your UPS system according to your requirements and the operating environment.

UPS-CP devices can be configured directly via the control panel, even with no external power supply, provided the batteries are charged:

- Quick status check via LED and illuminated LCD control panel
- Controlled computer shutdown by means of additional software
- Remote access via web browser with SNMP network card

Complete and extend your UPS system:

- DIN rails offer the option of installing the UPS-CP devices in 19" racks
- All devices can be extended with SNMP network cards or relay cards

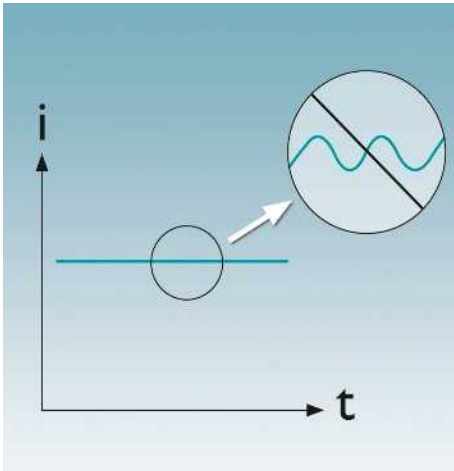

**Long battery life**

The special charge control of the UPS-CP devices ensures ripple-free DC voltage without higher-level AC currents.



**Integrated safety cut-off**

If required the UPS-CP devices can be integrated in a safety concept via a two-pos. connection.



**Easy battery replacement**

Batteries can be easily replaced during operation and when integrated. This is true for all UPS devices and battery modules.



**Stand-alone or 19" rack installation possible**

Depending on the application, the control panel on the UPS-CP devices can be rotated 90° for optimum display clarity.

# Power supply units and UPS

## Uninterruptible power supply units for 19" racks/towers

In order to select the ideal UPS, the power requirement of the connected loads and the required bridging time must be known. The diagrams illustrated can be used to select the appropriate UPS.

By adding external battery units, correspondingly longer bridging times can be achieved.

For the assignment and maximum possible number of external battery units, please refer to the table on the right.

UPS-CP-...	... BAT-1kVA-P1		... BAT-1kVA-P2		... BAT-2/3kVA-P3		... BAT-2/3kVA-P4		... BAT-4.5/6kVA-P5	
	Max. 2	Max. 1	—	—	Max. 4	Max. 2	—	—	Max. 5	Max. 5
...1kVA/240AC	Max. 2	Max. 1	—	—	Max. 4	Max. 2	—	—	Max. 5	Max. 5
...2kVA/240AC	—	—	Max. 4	Max. 2	—	—	—	—	—	—
...3kVA/240AC	—	—	Max. 4	Max. 2	—	—	—	—	—	—
...4.5kVA/240AC	—	—	—	—	—	—	—	—	Max. 5	Max. 5
...6kVA/240AC	—	—	—	—	—	—	—	—	Max. 5	Max. 5

### UPS-CP-1kVA/240AC

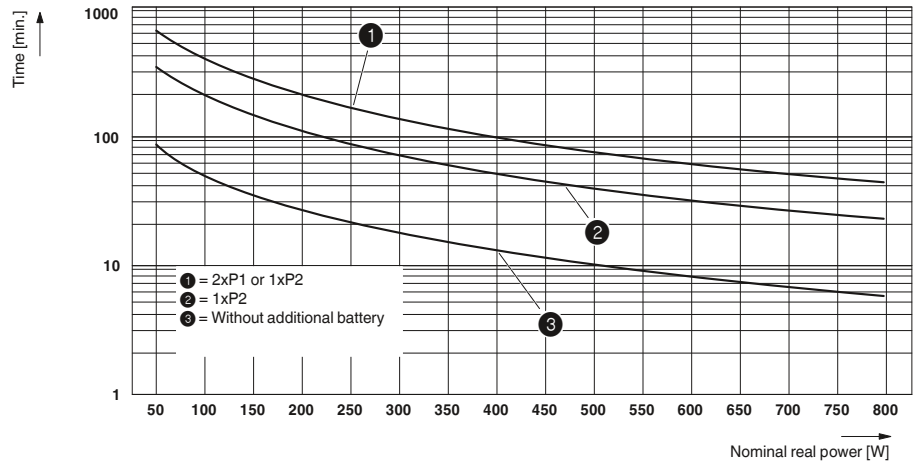

### UPS-CP-2kVA/240AC

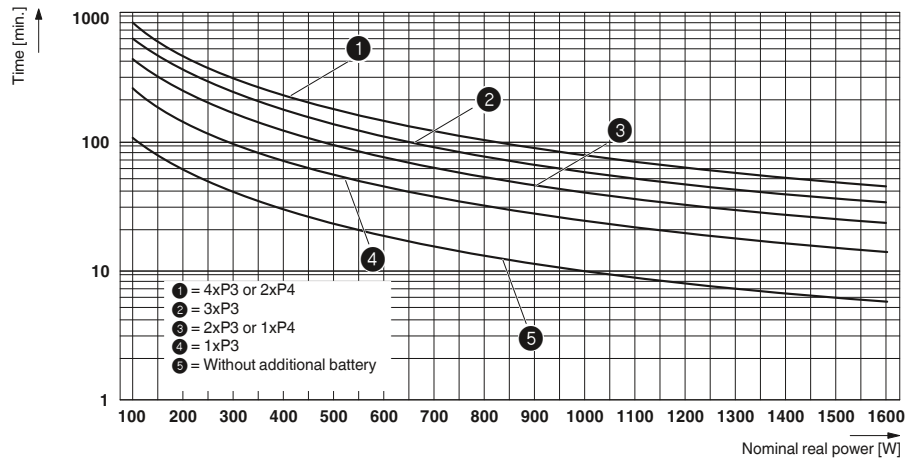

UPS-CP-3kVA/240AC

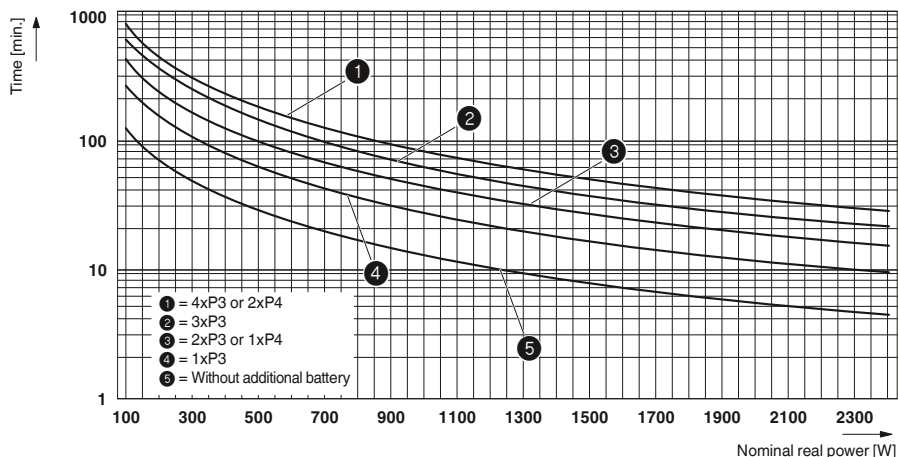

UPS-CP-4.5kVA/240AC

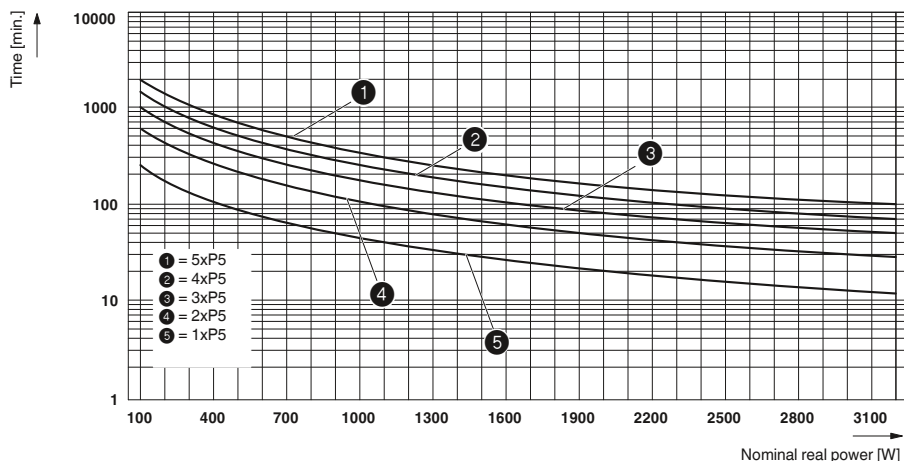

UPS-CP-6kVA/240AC

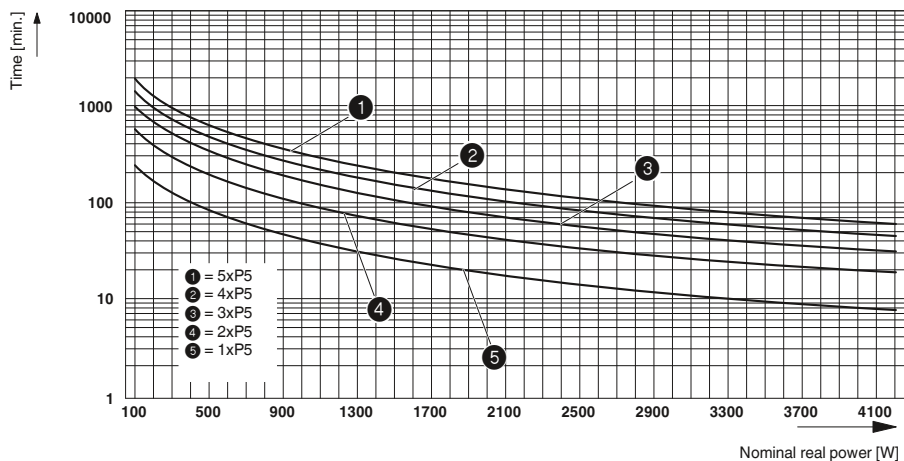

# Power supply units and UPS

## Uninterruptible power supply units for 19" racks/towers

### UPS devices

- Class VFI-SS-111 single-phase UPS (according to IEC 62040-3)
- Double conversion technology for maximum voltage quality
- Use as rack (19") or tower device with rotatable control panel
- Hot-swappable battery replacement on the front
- Long battery life thanks to ripple-free charging
- Mains-independent output voltage
- Comprehensive accessories for enhanced functions
- Supports a variety of operating systems



1 kVA nominal power



2 kVA nominal power

#### Notes:

1) EMC: Class A product, see page 287

Total width 483 mm

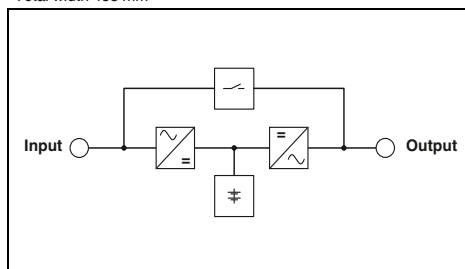

Total width 483 mm

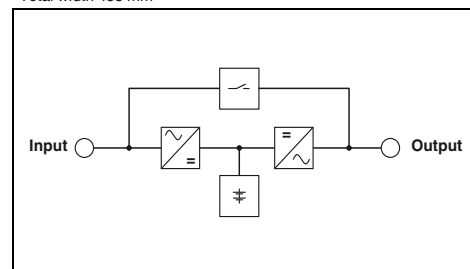

#### Technical data

Common characteristics	
Apparent power	1000 VA
Nominal power (real power)	800 W
Power factor	0.8
UPS topology	Double conversion technology
Classification	VFI-SS-111
UPS input side	
AC input voltage range	160 ... 288 V AC
AC frequency range	50 Hz ... 60 Hz +/-5 Hz (automatic recognition)
Nominal input current	3.8 A
Power factor (cos phi)	0.99 (with linear load)
Current distortion (THDi)	< 6 % (at full load)
UPS output side	
Output voltage range	230 V AC ±1% (200/208/220/230/240 V AC adjustable)
Nominal output current	4.35 A
AC frequency range	50 / 60 Hz (automatic recognition)
Battery system	
Battery type	VRLA
Bridging time	≥ 6 min
Charging time	4 h (90% charge)
Type of battery replacement	Hot-swappable
General data	
Ambient temperature (operation)	0 °C ... 40 °C
Ambient temperature (storage/transport)	0 °C ... 45 °C
Degree of protection	IP20
Height unit	2 HU
Design	19" rack/fix housing
Depth	490.00 mm
Permissible humidity (operation)	0 % ... 90 % (no condensation)
Noise level	50.00 dB(A)
Weight	19.00 kg

#### Technical data

Apparent power	2000 VA
Nominal power (real power)	1600 W
Power factor	0.8
UPS topology	Double conversion technology
Classification	VFI-SS-111
UPS input side	
AC input voltage range	160 ... 288 V AC
AC frequency range	50 Hz ... 60 Hz +/-5 Hz (automatic recognition)
Nominal input current	8 A
Power factor (cos phi)	0.99 (with linear load)
Current distortion (THDi)	< 6 % (at full load)
UPS output side	
Output voltage range	230 V AC ±1% (200/208/220/230/240 V AC adjustable)
Nominal output current	8.7 A
AC frequency range	50 / 60 Hz (automatic recognition)
Battery system	
Battery type	VRLA
Bridging time	≥ 6 min (Nominal load, in addition)
Charging time	4 h (90% charge)
Type of battery replacement	Hot-swappable
General data	
Ambient temperature (operation)	0 °C ... 40 °C
Ambient temperature (storage/transport)	0 °C ... 45 °C
Degree of protection	IP20
Height unit	2 HU
Design	19" rack/fix housing
Depth	680.00 mm
Permissible humidity (operation)	0 % ... 90 % (no condensation)
Noise level	50.00 dB(A)
Weight	30.00 kg

#### Ordering data

Description	Type	Order No.	Pcs. / Pkt.
<b>UPS compact</b>			
	UPS-CP-1KVA/240AC <sup>1)</sup>	2800274	1

#### Ordering data

Description	Type	Order No.	Pcs. / Pkt.
<b>UPS compact</b>			
	UPS-CP-2KVA/240AC <sup>1)</sup>	2800275	1

#### Accessories

<b>Optional power storage device</b>			
	UPS-CP-BAT-1KVA-P1	2800280	1
	UPS-CP-BAT-1KVA-P2	2800281	1
<b>DIN rail</b>			
For 19" rack installation	UPS-CP-19"MR	2800288	1

#### Accessories

<b>Optional power storage device</b>			
	UPS-CP-BAT-2/3KVA-P3	2800283	1
	UPS-CP-BAT-2/3KVA-P4	2800284	1
<b>DIN rail</b>			
For 19" rack installation	UPS-CP-19"MR	2800288	1



3 kVA nominal power



4.5 kVA nominal power



6 kVA nominal power

Total width 483 mm

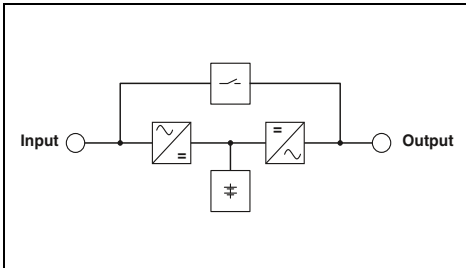

Total width 483 mm

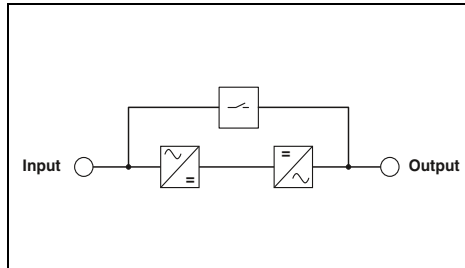

Total width 483 mm

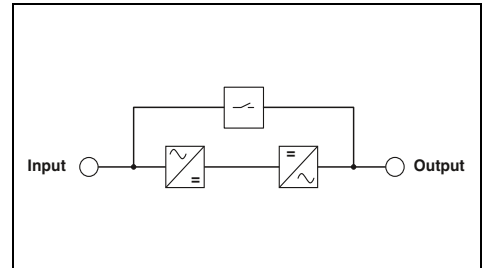

**Technical data**

3000 VA  
2400 W  
0.8  
Double conversion technology  
VFI-SS-111

160 ... 288 V AC  
50 Hz ... 60 Hz +/- 5 Hz (automatic recognition)

11.5 A  
0.99 (with linear load)  
< 6% (at full load)

230 V AC ±1% (200/208/220/230/240 V AC adjustable)

13.04 A  
50 / 60 Hz (automatic recognition)

VRLA  
≥ 5 min (Nominal load, in addition)  
4 h (90% charge)  
Hot-swappable

0 °C ... 40 °C  
0 °C ... 45 °C  
IP20  
2 HU  
19" rack/fixing housing  
680.00 mm  
0% ... 90% (no condensation)  
50.00 dB(A)  
33.00 kg

**Technical data**

4500 VA  
4050 W  
0.9  
Double conversion technology  
VFI-SS-111

160 ... 280 V AC  
50 Hz ... 60 Hz +/- 5 Hz (automatic recognition)

21.9 A  
0.99 (with linear load)  
< 6% (at full load)

230 V AC ±1% (200/208/220/230/240 V AC adjustable)

19.57 A  
50 / 60 Hz (automatic recognition)

-  
9 min (Full load)  
-  
-

0 °C ... 40 °C  
0 °C ... 45 °C  
IP20  
2 HU  
19" rack/fixing housing  
680.00 mm  
0% ... 90% (no condensation)  
50.00 dB(A)  
22.00 kg

**Technical data**

6000 VA  
5400 W  
0.9  
Double conversion technology  
VFI-SS-111

160 ... 280 V AC  
50 Hz ... 60 Hz +/- 5 Hz (automatic recognition)

28.48 A  
0.99 (with linear load)  
< 6% (at full load)

230 V AC ±1% (200/208/220/230/240 V AC adjustable)

26.09 A  
50 / 60 Hz (automatic recognition)

-  
6 min (Full load)  
-  
-

0 °C ... 40 °C  
0 °C ... 45 °C  
IP20  
2 HU  
19" rack/fixing housing  
680.00 mm  
0% ... 90% (no condensation)  
50.00 dB(A)  
22.00 kg

**Ordering data**

Type	Order No.	Pcs. / Pkt.
UPS-CP-3KVA/240AC <sup>1)</sup>	2800276	1

**Accessories**

UPS-CP-BAT-2/3KVA-P3	2800283	1
UPS-CP-BAT-2/3KVA-P4	2800284	1
UPS-CP-19"MR	2800288	1

**Ordering data**

Type	Order No.	Pcs. / Pkt.
UPS-CP-4.5KVA/240AC <sup>1)</sup>	2800277	1

**Accessories**

UPS-CP-19"MR	2800288	1
--------------	---------	---

**Ordering data**

Type	Order No.	Pcs. / Pkt.
UPS-CP-6KVA/240AC <sup>1)</sup>	2800278	1

**Accessories**

UPS-CP-19"MR	2800288	1
--------------	---------	---

# Power supply units and UPS

## Uninterruptible power supply units for 19" racks/towers

### Power storage devices

- Power storage for increasing the duration of the bridging
- Hot-swappable battery replacement
- Error-free connection thanks to adapted connection method



For UPS-CP-1KVA, 19 minutes (nominal load)



For UPS-CP-1KVA, 36 minutes (nominal load)

Battery system	
Battery type	VRLA
Battery capacity	14.40 Ah
Bridging time	19 min (Nominal load, in addition)
Bridging time	-
Charging time	4 h (90% charge)
Type of battery replacement	Hot-swappable
General data	
Ambient temperature (operation)	0 °C ... 40 °C
Ambient temperature (storage/transport)	0 °C ... 45 °C
Degree of protection	IP20
Height unit	2 HU
Design	19" rack/fixing housing
Depth	680.00 mm
Weight	29.00 kg

Total width 483 mm

Technical data		
VRLA		
14.40 Ah		
19 min (Nominal load, in addition)		
-		
4 h (90% charge)		
Hot-swappable		
0 °C ... 40 °C		
0 °C ... 45 °C		
IP20		
2 HU		
19" rack/fixing housing		
680.00 mm		
29.00 kg		

Total width 483 mm

Technical data		
VRLA		
28.80 Ah		
36 min (Nominal load, in addition)		
-		
4 h (90% charge)		
Hot-swappable		
0 °C ... 40 °C		
0 °C ... 45 °C		
IP20		
2 HU		
19" rack/fixing housing		
680.00 mm		
44.00 kg		

Ordering data			
Description	Type	Order No.	Pcs. / Pkt.
Optional power storage device	UPS-CP-BAT-1KVA-P1	2800280	1

Ordering data			
Description	Type	Order No.	Pcs. / Pkt.
Optional power storage device	UPS-CP-BAT-1KVA-P2	2800281	1

Accessories			
DIN rail	UPS-CP-19"MR	2800288	1
For 19" rack installation			

Accessories			
DIN rail	UPS-CP-19"MR	2800288	1
For 19" rack installation			





For UPS-CP-2KVA, 8 minutes (nominal load)  
For UPS-CP-3KVA, 5 minutes (nominal load)



For UPS-CP-2KVA, 19 minutes (nominal load)  
For UPS-CP-3KVA, 12 minutes (nominal load)



For UPS-CP-4.5KVA, 10 minutes (nominal load)  
For UPS-CP-6KVA, 8 minutes (nominal load)

Total width 483 mm

Total width 483 mm

Total width 483 mm

Technical data	
VRLA	
7.20 Ah	
8 min (nominal load - 2 kVA)	
5 min (nominal load - 3 kVA)	
4 h (90% charge)	
Hot-swappable	
0 °C ... 40 °C	
0 °C ... 45 °C	
IP20	
2 HU	
19" rack/fixed housing	
680.00 mm	
29.00 kg	

Technical data	
VRLA	
14.40 Ah	
19 min (nominal load - 2 kVA)	
12 min (nominal load - 3 kVA)	
4 h (90% charge)	
Hot-swappable	
0 °C ... 40 °C	
0 °C ... 45 °C	
IP20	
2 HU	
19" rack/fixed housing	
680.00 mm	
44.00 kg	

Technical data	
VRLA	
7.20 Ah	
9 min (Nominal load - 4.5 kVA)	
6 min (nominal load - 6 kVA)	
4 h (90% charge)	
Hot-swappable	
0 °C ... 40 °C	
0 °C ... 45 °C	
IP20	
3 HU	
19" rack/fixed housing	
680.00 mm	
70.00 kg	

Ordering data		
Type	Order No.	Pcs. / Pkt.
UPS-CP-BAT-2/3KVA-P3	2800283	1

Ordering data		
Type	Order No.	Pcs. / Pkt.
UPS-CP-BAT-2/3KVA-P4	2800284	1

Ordering data		
Type	Order No.	Pcs. / Pkt.
UPS-CP-BAT-4.5/6KVA-P5	2800285	1

Accessories		
Type	Order No.	Pcs. / Pkt.
UPS-CP-19"MR	2800288	1

Accessories		
Type	Order No.	Pcs. / Pkt.
UPS-CP-19"MR	2800288	1

Accessories		
Type	Order No.	Pcs. / Pkt.
UPS-CP-19"MR	2800288	1





External bypass module



Multiple socket strip



Module for parallel/redundancy operation with external bypass

Total width 482.6 mm

Total width 483 mm

Total width 483 mm

Technical data	
... 1/2/3KVA	... 4.5/6KVA
240 V AC max. 16 A Socket C20 - IEC 60320	240 V AC max. 32 A Cable L/N/PE
240 V AC 16 A (thermal fuse)	240 V AC 32 A
6 x C13/10 A - IEC 60320	Cable L/N/PE; 2.8 m; open ends
-	-
0 °C ... 40 °C	0 °C ... 40 °C
0 °C ... 45 °C	0 °C ... 45 °C
IP20	IP20
19" rack patch module	19" rack patch module

Technical data		
... 9X10A-IEC	... 4X16A-IEC	... 5X16A/9X10A-IEC
240 V AC max. 16 A C20 - IEC 60320	240 V AC max. 16 A C20 - IEC 60320	240 V AC max. 32 A Terminal block base - L/N/PE
240 V AC 10 A (thermal fuse)	240 V AC 16 A (thermal fuse)	240 V AC 16 A (10 A/thermal fuse)
9 x C13 - IEC 60320	4 x C19 - IEC 60320	5 x C19/16 A - IEC 60320
-	-	-
0 °C ... 40 °C	0 °C ... 40 °C	0 °C ... 40 °C
0 °C ... 45 °C	0 °C ... 45 °C	0 °C ... 45 °C
IP20	IP20	IP20
19" rack patch module	19" rack patch module	19" rack patch module

Technical data	
... 32A-4.5/6KV	... 63A-4.5/6KV
240 V AC max. 32 A Cable L/N/PE; 2.8 m; open ends	240 V AC max. 63 A Cable L/N/PE; 2.8 m; open ends
240 V AC 32 A	240 V AC 63 A
Cable L/N/PE; 2.8 m; open ends	Cable L/N/PE; 2.8 m; open ends
-	-
0 °C ... 40 °C	0 °C ... 40 °C
0 °C ... 45 °C	0 °C ... 45 °C
IP20	IP20
19" rack patch module	19" rack patch module

Ordering data		
Type	Order No.	Pcs. / Pkt.
UPS-CP-BP-1/2/3KVA	2800291	1
UPS-CP-BP-4.5/6KVA	2800292	1

Ordering data		
Type	Order No.	Pcs. / Pkt.
UPS-CP-MS-9X10A-IEC	2800293	1
UPS-CP-MS-4X16A-IEC	2800294	1
UPS-CP-MS-5X16A/9X10A-IEC	2800296	1

Ordering data		
Type	Order No.	Pcs. / Pkt.
UPS-CP-PU-240AC/32A-4.5/6KV	2800297	1
UPS-CP-PU-240AC/63A-4.5/6KV	2800298	1

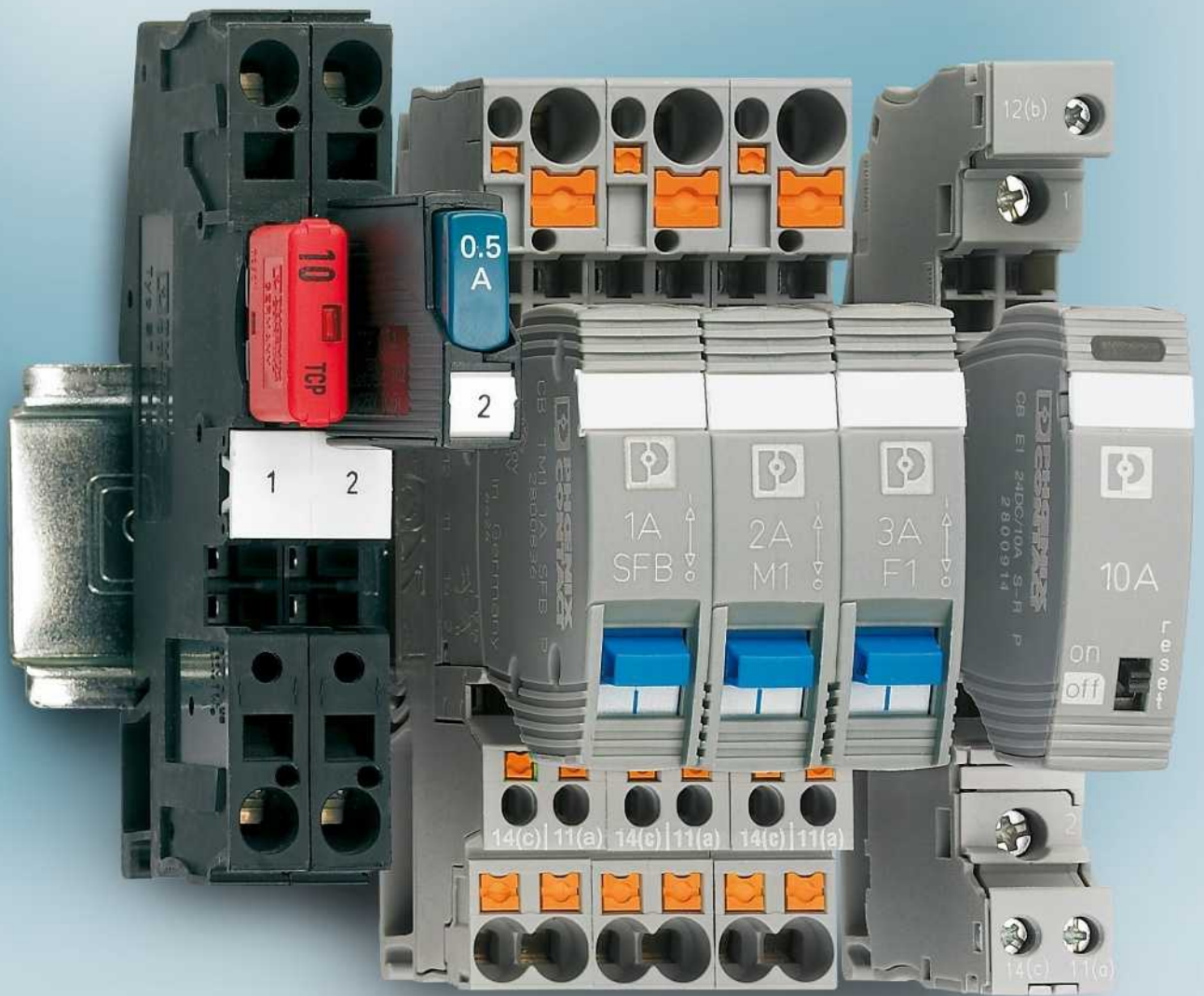

# Protective devices

## High-grade device circuit breakers offer safety for your systems

Device circuit breakers are a key factor in high system availability. In the event of overload and short-circuit currents, they selectively shut down the faulty circuit.

<b>Introduction</b>	<b>252</b>
<b>Product overview</b>	<b>254</b>
<b>CB series device circuit breakers</b>	
Electronic circuit breakers	<b>256</b>
Thermomagnetic circuit breakers	<b>213</b>
Device circuit breaker board	<b>262</b>
<b>Device circuit breakers</b>	
Thermomagnetic circuit breakers	<b>263</b>
Thermal circuit breakers	<b>264</b>
Electronic circuit breakers	<b>268</b>

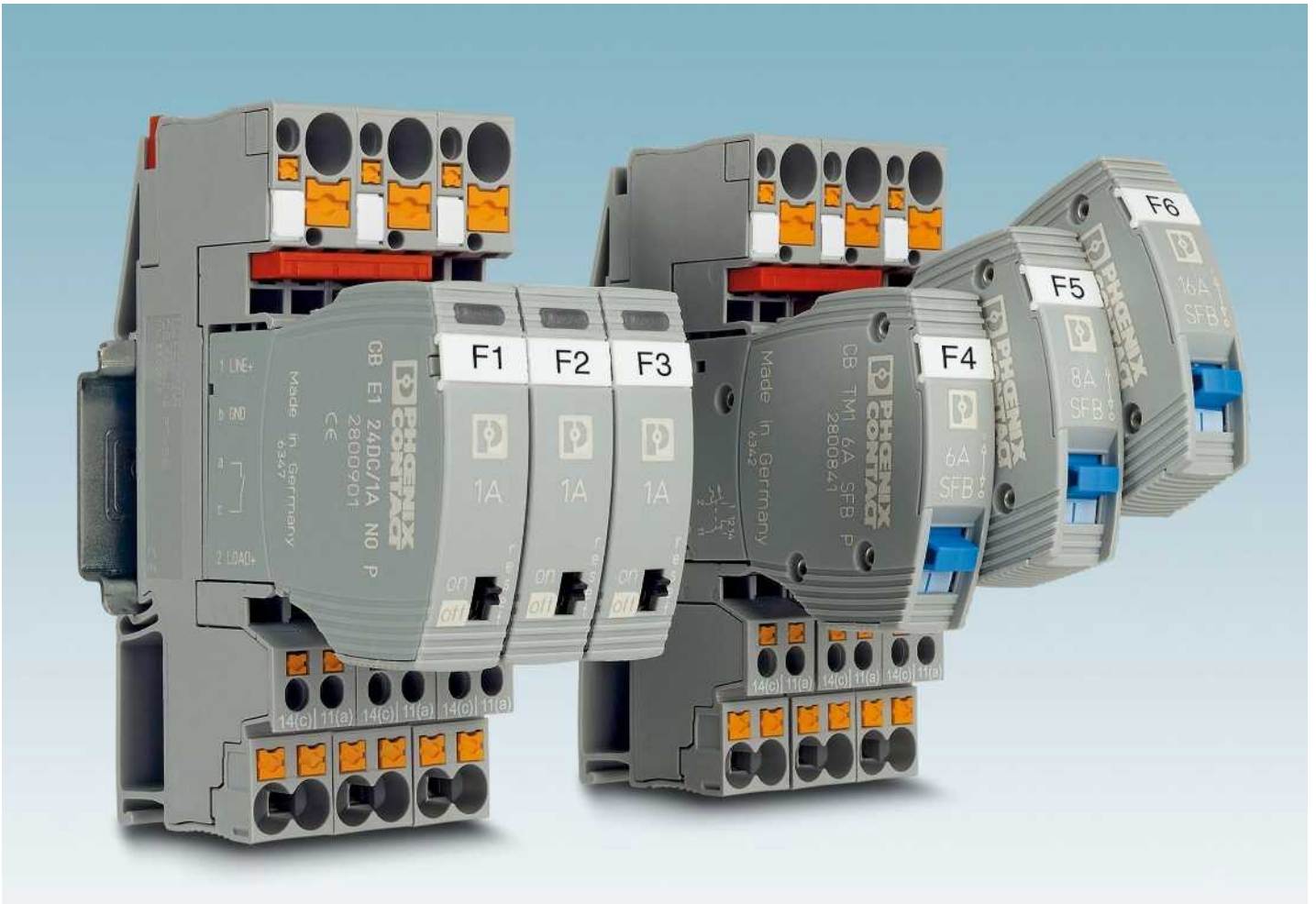

### Branch out

The device circuit breakers provide reliable protection even if your systems involve long cable paths. Together with the SFB technology\* of the QUINT POWER power supply units, the special SFB trigger characteristic of the CB device circuit breakers ensures fast shutdown in the event of an error. This combination offers maximum protection against overload and short-circuit currents.

\*SFB = Selective fuse breaking, selective shutdown

### Individual adaptation

You can pre-wire your systems with base elements and individually equip them with protective plugs on site. The device circuit breakers can also be quickly adapted to accommodate necessary changes in your system. Should you change a load, simply replace the relevant protective plug. Various tripping methods, characteristic curves, and nominal currents are available depending on the application.

### Modular extension

It couldn't be easier. Enhance your system with additional device circuit breakers in no time at all. You can bridge the power distribution, remote signaling or even the auxiliary voltage for electronic circuit breakers without this resulting in significant wiring costs. The uniform, plug-in housing concept as well as the bridgeability of the base elements simplify installation.

### Device circuit breaker board

The multi-channel circuit breaker boards are used in standard production machines or in control and process technology, for example.

Central potential distribution minimizes the time and effort that has to be spent on installation. The boards are very versatile in application, as each one is populated with thermomagnetic circuit breakers individually.



**Latching**

You can quickly and easily remove the plugs from the base element. The new latching ensures a secure fit in harsh environments and where there are vibrations in the installation environment. It holds the plug in place in the base element.



**Coding**

Straightforward coding means that components can be mounted on the base element according to individual requirements without any errors.

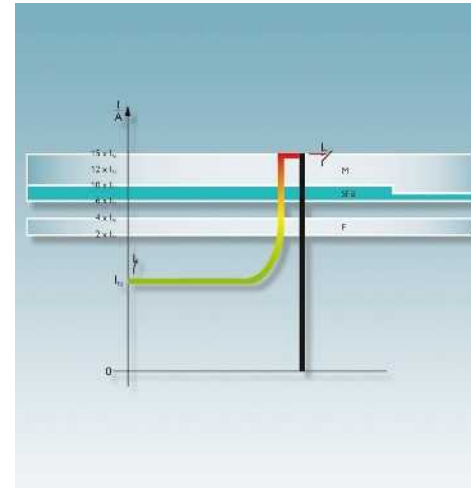

**SFB trigger characteristic**

Thermomagnetic device circuit breakers with the SFB trigger characteristic\* provide maximum overcurrent protection – even in large systems with long cable paths.



**Bridge**

With the unique bridge system from our standard range, the device circuit breakers can be combined easily as per your requirements. Potentials of the same type can be connected quickly and safely.



**Variable connection technologies**

You can choose base elements with either push-in or screw connection technology.



**Device circuit breaker board**

The multi-channel device circuit breaker boards are available with 4, 8 or 12 channels.

# Protective devices

## Product overview

### Circuit breakers: electronic



**CB E1...**  
Page 256



**EC-E1 + EC-E4**  
Page 268  
**EC-E**  
Page 269



**ECP-E**  
Page 270  
**ECP-E2**  
Page 271  
**ECP-E3**  
Page 272

### Selective



**ECP ...**  
Page 273

### Thermal



**TCP ...32V**  
Page 264



**TCP ...**  
Page 265

### Circuit breakers: thermomagnetic



**CB-TM1...SFB**  
Page 259  
**CB-TM2...SFB**  
Page 259



**CB-TM1...M1 P**  
Page 260  
**CB-TM1...F1 P**  
Page 260



**CB-TM2...M1 P**  
Page 260  
**CB-TM2...F1 P**  
Page 260



**UT 6-TMC M**  
Page 263



**TMC 1 F1 100 0,2A**  
Page 266



**TMCP 1 F1 300 0,2A**  
Page 266

### Board



**CBB TM 04...P-PT**  
Page 262  
**CBB TM 08...P-PT**  
Page 262  
**CBB TM 12...P-PT**  
Page 262



CB device circuit breakers

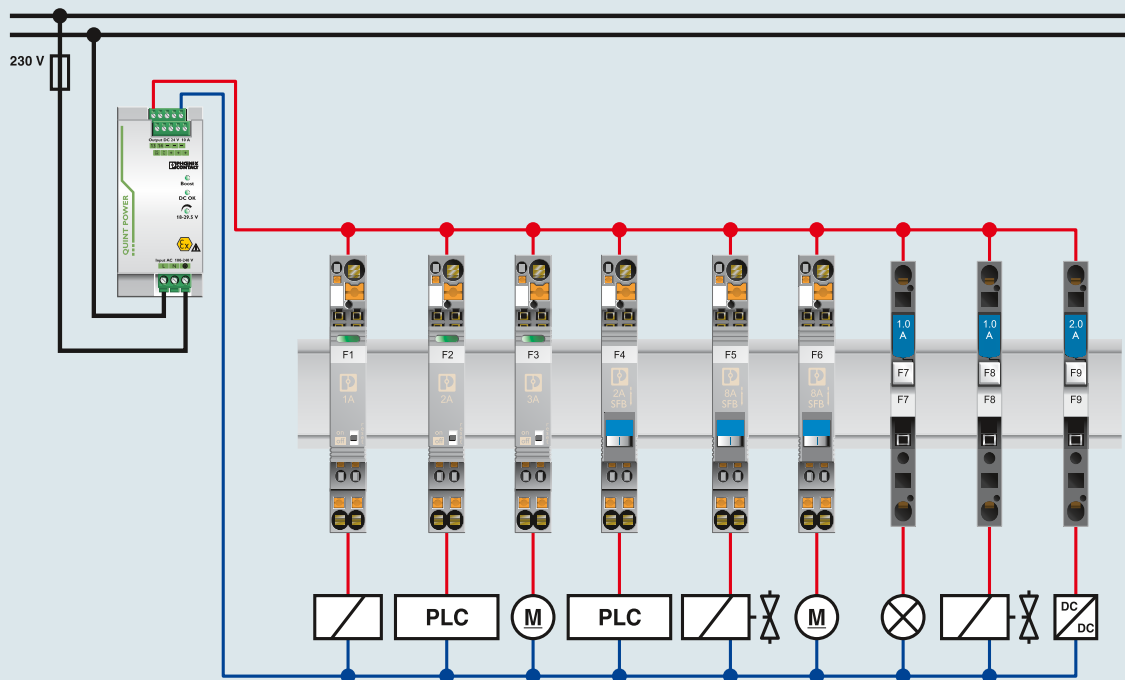

CB E1...

Page 256

CB-TM1...

Page 259

TCP ...

Page 265

Device circuit breaker board

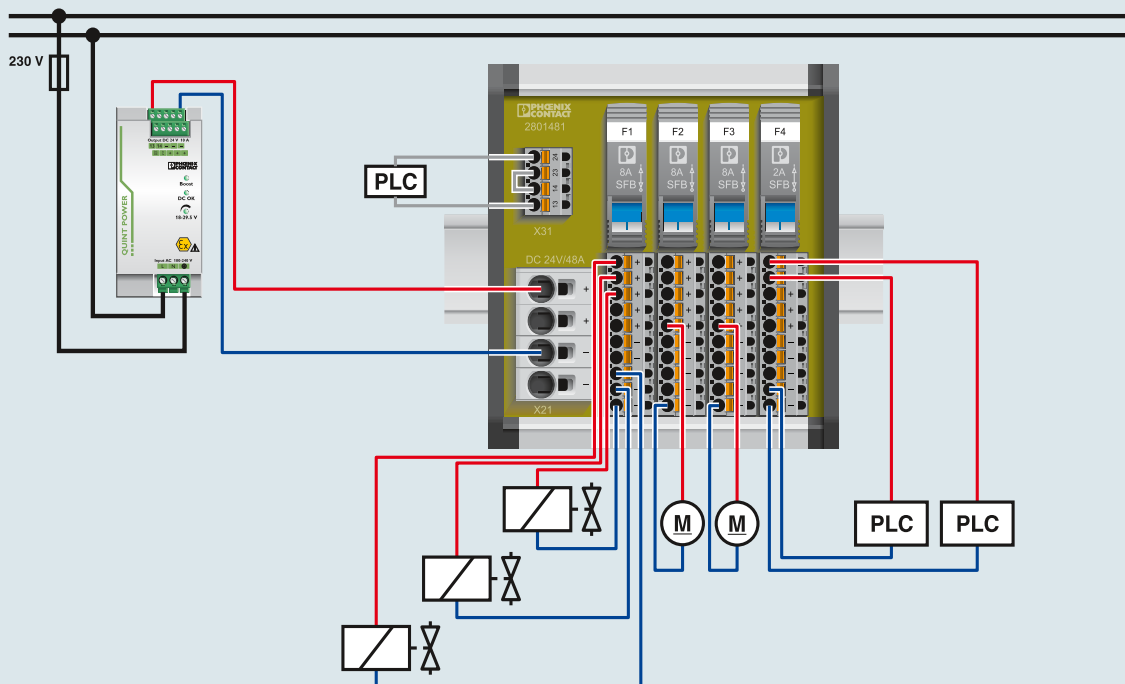

CBB TM...P-PT

Page 262

# Protective devices

## Device circuit breakers

### Plug-in electronic circuit breakers

- Device circuit breakers for protecting against voltage dips caused by overloads and short circuits
- Integrated active current limitation
- Remote control possible
- Maximum ease of maintenance thanks to the two-piece design
- Snap-in function for secure hold and easy removal
- Plug coding possible
- Narrow design

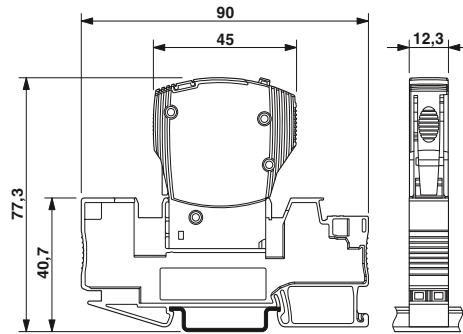

The figure shows the complete module consisting of a base element and connector



1 N/O contact

Total width 12.3 mm

#### Technical data

<b>Rated data</b>	
Operating voltage	24 V DC
Nominal current $I_N$	Depends on the selected item version
<b>Disconnection</b>	
Switch-off time	See trigger characteristic
Switch off	typ. $1.25 \times I_N$
Current limitation	active
<b>General data</b>	
Temperature range	0 °C ... 50 °C (without condensation)
Degree of protection	IP30 (Actuation area)
Standards/regulations	UL 2367 / UL 508 / CSA 22.2 / EN 61000-6-3

24 V DC  
Depends on the selected item version

See trigger characteristic  
typ.  $1.25 \times I_N$   
active

0 °C ... 50 °C (without condensation)  
IP30 (Actuation area)  
UL 2367 / UL 508 / CSA 22.2 / EN 61000-6-3

#### Ordering data

Description	Nominal current
<b>Electronic circuit breaker, 1-pos.</b>	
	1 A
	2 A
	3 A
	4 A
	6 A
	8 A
	10 A

Type	Order No.	Pcs. / Pkt.
CB E1 24DC/1A NO P	2800901	1
CB E1 24DC/2A NO P	2800902	1
CB E1 24DC/3A NO P	2800903	1
CB E1 24DC/4A NO P	2800904	1
CB E1 24DC/6A NO P	2800905	1

#### Accessories

<b>Bridge plug, 0 volt distribution</b>
<b>Base element</b>
With push-in connection technology
With screw connection technology
<b>Plug-in bridge, for cross connections in the bridge shaft</b>

CB PT BRIDGE	2801014	1
CB 1/6-2/4 PT-BE	2800929	10
CB 1/10-1/10 UT-BE	2801305	10
For FBS ..., see page 258		

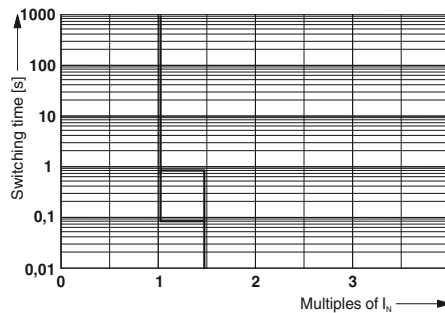

Trigger characteristic



1 N/C contact



1 x Reset IN + 1 x Status OUT



1 x Control IN + 1 x Status OUT

Total width 12.3 mm

Total width 12.3 mm

Total width 12.3 mm

Technical data
24 V DC Depends on the selected item version
See trigger characteristic typ. 1.25 x I <sub>N</sub> active
0 °C ... 50 °C (without condensation) IP30 (Actuation area) UL 2367 / UL 508 / CSA 22.2 / EN 61000-6-3

Technical data
24 V DC Depends on the selected item version
See trigger characteristic typ. 1.25 x I <sub>N</sub> active
0 °C ... 50 °C (without condensation) IP30 (Actuation area) UL 2367 / UL 508 / CSA 22.2 / EN 61000-6-3

Technical data
24 V DC Depends on the selected item version
See trigger characteristic typ. 1.25 x I <sub>N</sub> active
0 °C ... 50 °C (without condensation) IP30 (Actuation area) UL 2367 / UL 508 / CSA 22.2 / EN 61000-6-3

Ordering data		
Type	Order No.	Pcs. / Pkt.
CB E1 24DC/1A NC P	2800915	1
CB E1 24DC/2A NC P	2800916	1
CB E1 24DC/3A NC P	2800917	1
CB E1 24DC/4A NC P	2800918	1
CB E1 24DC/6A NC P	2800919	1

Ordering data		
Type	Order No.	Pcs. / Pkt.
CB E1 24DC/1A S-R P	2800908	1
CB E1 24DC/2A S-R P	2800909	1
CB E1 24DC/3A S-R P	2800910	1
CB E1 24DC/4A S-R P	2800911	1
CB E1 24DC/6A S-R P	2800912	1
CB E1 24DC/8A S-R P	2800913	1
CB E1 24DC/10A S-R P	2800914	1

Ordering data		
Type	Order No.	Pcs. / Pkt.
CB E1 24DC/1A S-C P	2800922	1
CB E1 24DC/2A S-C P	2800923	1
CB E1 24DC/3A S-C P	2800924	1
CB E1 24DC/4A S-C P	2800925	1
CB E1 24DC/6A S-C P	2800926	1
CB E1 24DC/8A S-C P	2800927	1
CB E1 24DC/10A S-C P	2800928	1

Accessories		
Type	Order No.	Pcs. / Pkt.
CB PT BRIDGE	2801014	1
CB 1/6-2/4 PT-BE	2800929	10
CB 1/10-1/10 UT-BE	2801305	10

Accessories		
Type	Order No.	Pcs. / Pkt.
CB PT BRIDGE	2801014	1
CB 1/6-2/4 PT-BE	2800929	10
CB 1/10-1/10 UT-BE	2801305	10

Accessories		
Type	Order No.	Pcs. / Pkt.
CB PT BRIDGE	2801014	1
CB 1/6-2/4 PT-BE	2800929	10
CB 1/10-1/10 UT-BE	2801305	10

For FBS ..., see page 258

For FBS ..., see page 258

For FBS ..., see page 258

# Protective devices

## Device circuit breakers

### Base element and plug-in bridges

N

#### Base elements

- For accommodating CB TM.../CB E.... device circuit breakers
- Rail-mountable module
- With bridge shafts
- Systematic structure with 1-channel base elements possible

**Notes:**  
Can be loaded with up to 41 A if two bridges are connected for the supply.

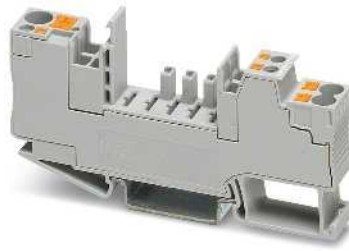

1-pos. with push-in connection, input 1 x 6 mm<sup>2</sup>/output 2 x 4 mm<sup>2</sup>

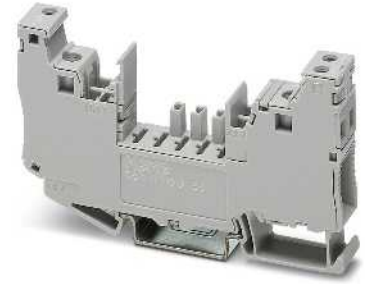

1-pos. with screw connection, input 1 x 10 mm<sup>2</sup>/output 1 x 10 mm<sup>2</sup>

Rated surge voltage	4 kV
<b>General data</b>	
Dimensions W / H / D	12.3 mm / 90 mm / 46.7 mm
Connection method	Push-in connection
Temperature range	-30 °C ... 60 °C
Degree of protection	IP30 (Actuation area)
Inflammability class according to UL 94	V0
Standards/regulations	IEC 60947-7-1

Total width 12.3 mm

<b>Technical data</b>		
Rated surge voltage	4 kV	
<b>General data</b>		
Dimensions W / H / D	12.3 mm / 90 mm / 46.7 mm	
Connection method	Push-in connection	
Temperature range	-30 °C ... 60 °C	
Degree of protection	IP30 (Actuation area)	
Inflammability class according to UL 94	V0	
Standards/regulations	IEC 60947-7-1	

Total width 12.3 mm

<b>Technical data</b>		
Rated surge voltage	2.5 kV	
<b>General data</b>		
Dimensions W / H / D	12.3 mm / 90.8 mm / 70 mm	
Connection method	Screw connection	
Temperature range	-30 °C ... 60 °C	
Degree of protection	IP30 (Actuation area)	
Inflammability class according to UL 94	V0	
Standards/regulations	UL 1059	

<b>Ordering data</b>			
Description	Type	Order No.	Pcs. / Pkt.
<b>Base element</b>	CB 1/6-2/4 PT-BE	2800929	10

<b>Ordering data</b>			
Description	Type	Order No.	Pcs. / Pkt.
<b>Base element</b>	CB 1/10-1/10 UT-BE	2801305	10

<b>Accessories</b>				
<b>Plug-in bridge, red</b>	Number of positions			
	2	FBS 2-6	3030336	50
	3	FBS 3-6	3030242	50
	4	FBS 4-6	3030255	50
	5	FBS 5-6	3030349	50
	10	FBS 10-6	3030271	10
	20	FBS 20-6	3030365	10
	50	FBS 50-6	3032224	10
<b>Plug-in bridge, blue</b>	Number of positions			
	2	FBS 2-6 BU	3036932	50
	3	FBS 3-6 BU	3036945	50
	4	FBS 4-6 BU	3036958	50
	5	FBS 5-6 BU	3036961	50
	10	FBS 10-6 BU	3032198	10
	20	FBS 20-6 BU	3032208	10
	50	FBS 50-6 BU	3032211	10
<b>Plug-in bridge, gray</b>	Number of positions			
	2	FBS 2-6 GY	3032237	50
	3	FBS 3-6 GY	3032240	50
	4	FBS 4-6 GY	3032279	50
	5	FBS 5-6 GY	3032266	50
	10	FBS 10-6 GY	3032253	10

<b>Accessories</b>				
<b>Plug-in bridge, red</b>	Number of positions			
	2	FBS 2-6	3030336	50
	3	FBS 3-6	3030242	50
	4	FBS 4-6	3030255	50
	5	FBS 5-6	3030349	50
	10	FBS 10-6	3030271	10
	20	FBS 20-6	3030365	10
	50	FBS 50-6	3032224	10
<b>Plug-in bridge, blue</b>	Number of positions			
	2	FBS 2-6 BU	3036932	50
	3	FBS 3-6 BU	3036945	50
	4	FBS 4-6 BU	3036958	50
	5	FBS 5-6 BU	3036961	50
	10	FBS 10-6 BU	3032198	10
	20	FBS 20-6 BU	3032208	10
	50	FBS 50-6 BU	3032211	10
<b>Plug-in bridge, gray</b>	Number of positions			
	2	FBS 2-6 GY	3032237	50
	3	FBS 3-6 GY	3032240	50
	4	FBS 4-6 GY	3032279	50
	5	FBS 5-6 GY	3032266	50
	10	FBS 10-6 GY	3032253	10

<b>Accessories</b>				
<b>Plug-in bridge, red</b>	Number of positions			
	2	FBS 2-6	3030336	50
	3	FBS 3-6	3030242	50
	4	FBS 4-6	3030255	50
	5	FBS 5-6	3030349	50
	10	FBS 10-6	3030271	10
	20	FBS 20-6	3030365	10
	50	FBS 50-6	3032224	10
<b>Plug-in bridge, blue</b>	Number of positions			
	2	FBS 2-6 BU	3036932	50
	3	FBS 3-6 BU	3036945	50
	4	FBS 4-6 BU	3036958	50
	5	FBS 5-6 BU	3036961	50
	10	FBS 10-6 BU	3032198	10
	20	FBS 20-6 BU	3032208	10
	50	FBS 50-6 BU	3032211	10
<b>Plug-in bridge, gray</b>	Number of positions			
	2	FBS 2-6 GY	3032237	50
	3	FBS 3-6 GY	3032240	50
	4	FBS 4-6 GY	3032279	50
	5	FBS 5-6 GY	3032266	50
	10	FBS 10-6 GY	3032253	10

**Plug-in thermomagnetic circuit breakers**

- Device circuit breakers for protecting against voltage dips caused by overloads and short circuits
- SFB characteristic curve enables longer cables and release times < 10 ms
- Maximum ease of maintenance thanks to the two-piece design
- Snap-in function for secure hold and easy removal
- Plug coding possible
- Narrow design

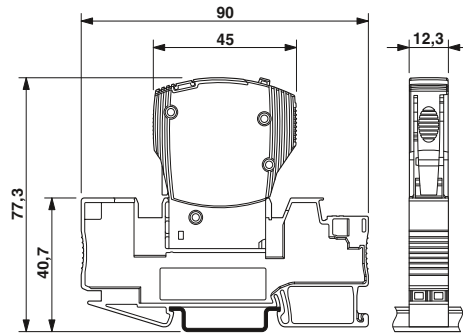

The figure shows the complete module consisting of a base element and connector



Can be plugged in, SFB characteristic curve

Total width 12.3 mm

<b>Rated data</b>	
Rated voltage	
Rated voltage	
Rated current $I_n$	
<b>Disconnection</b>	
Switch-off time	
Fuse type	
Rated short-circuit switching capacity $I_{cn}$	
Cycles, max.	
<b>General data</b>	
Temperature range	
Degree of protection	
Standards/regulations	

<b>Technical data</b>	
IEC	UL/CUL
240 V AC	277 V AC
50 V DC	50 V DC
Depends on the selected item version	
See trigger characteristic	
SFB	
300 A (240 V AC) / 600 A (50 V DC)	
6000 (at 1 x $I_n$ )	
-30 °C ... 60 °C	
IP30 (Actuation area)	
EN 60934 / UL 1077 / UL 508 / CSA 22.2	

Description	Nominal current
<b>Thermomagnetic circuit breaker, plug-in, 1-pos., signal contact 1 PDT</b>	
	0.5 A
	1 A
	2 A
	3 A
	4 A
	5 A
	6 A
	8 A
	10 A
	12 A
	16 A
<b>Thermomagnetic circuit breaker, plug-in, 2-pos., signal contact 1 PDT</b>	
	0.5 A
	1 A
	2 A
	3 A
	4 A
	5 A
	6 A
	8 A
	10 A
	12 A
	16 A

<b>Ordering data</b>			
Type	Order No.	Pcs. / Pkt.	
CB TM1 0.5A SFB P	2800835	1	
CB TM1 1A SFB P	2800836	1	
CB TM1 2A SFB P	2800837	1	
CB TM1 3A SFB P	2800838	1	
CB TM1 4A SFB P	2800839	1	
CB TM1 5A SFB P	2800840	1	
CB TM1 6A SFB P	2800841	1	
CB TM1 8A SFB P	2800842	1	
CB TM1 10A SFB P	2800843	1	
CB TM1 12A SFB P	2800844	1	
CB TM1 16A SFB P	2800845	1	
CB TM2 0.5A SFB P	2800868	1	
CB TM2 1A SFB P	2800869	1	
CB TM2 2A SFB P	2800870	1	
CB TM2 3A SFB P	2800871	1	
CB TM2 4A SFB P	2800872	1	
CB TM2 5A SFB P	2800873	1	
CB TM2 6A SFB P	2800874	1	
CB TM2 8A SFB P	2800875	1	
CB TM2 10A SFB P	2800876	1	
CB TM2 12A SFB P	2800877	1	
CB TM2 16A SFB P	2800878	1	

<b>Accessories</b>			
CB PT BRIDGE	2801014	1	
CB 1/6-2/4 PT-BE	2800929	10	
CB 1/10-1/10 UT-BE	2801305	10	

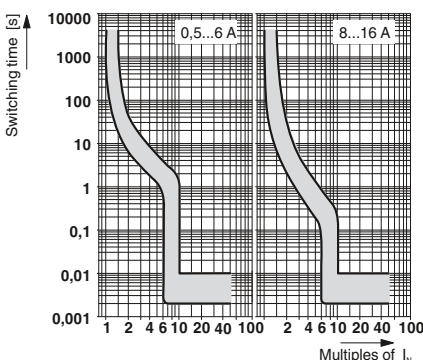

Trigger characteristic in the DC range

<b>Bridge plug, 0 volt distribution</b>
<b>Base element</b>
With push-in connection technology
With screw connection technology

# Protective devices

## Device circuit breakers

### Plug-in thermomagnetic circuit breakers

- Device circuit breakers for protecting against voltage dips caused by overloads and short circuits
- Medium-blow and fast-blow tripping characteristics
- 1 and 2-pos. circuit breakers
- Maximum ease of maintenance thanks to the two-piece design
- Snap-in function for secure hold and easy removal
- Plug coding possible
- Narrow design

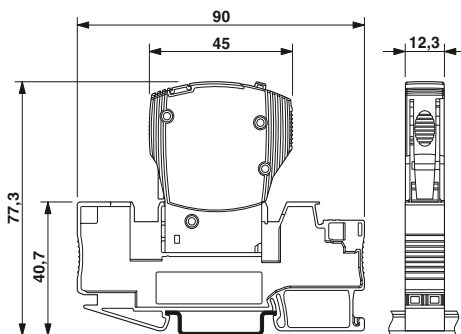

The figure shows the complete module consisting of a base element and connector



Can be plugged in, M1 characteristic curve, 1-pos.

UL 1008 1008  
Total width 12.3 mm

Rated data	
Rated voltage	240 V AC
Rated voltage	277 V AC
Rated voltage	50 V DC
Rated current $I_n$	Depends on the selected item version
Disconnection	
Switch-off time	See trigger characteristic
Fuse type	normal blow
Rated short-circuit switching capacity $I_{cn}$	300 A (240 V AC) / 600 A (50 V DC)
Cycles, max.	6000 (at 1 x $I_n$ )
General data	
Temperature range	-30 °C ... 60 °C
Degree of protection	IP30 (Actuation area)
Standards/regulations	EN 60934 / UL 1077 / UL 508 / CSA 22.2

Technical data	
IEC	UL/CUL
240 V AC	277 V AC
50 V DC	50 V DC
Depends on the selected item version	
See trigger characteristic	
normal blow	
300 A (240 V AC) / 600 A (50 V DC)	
6000 (at 1 x $I_n$ )	
-30 °C ... 60 °C	
IP30 (Actuation area)	
EN 60934 / UL 1077 / UL 508 / CSA 22.2	

Description	Nominal current
<b>Thermomagnetic circuit breaker, plug-in, signal contact 1 PDT</b>	
	0.5 A
	1 A
	2 A
	3 A
	4 A
	5 A
	6 A
	8 A
	10 A
	12 A
	16 A

Ordering data			
Type	Order No.	Pcs. / Pkt.	
CB TM1 0.5A M1 P	2800846	1	
CB TM1 1A M1 P	2800847	1	
CB TM1 2A M1 P	2800848	1	
CB TM1 3A M1 P	2800849	1	
CB TM1 4A M1 P	2800850	1	
CB TM1 5A M1 P	2800851	1	
CB TM1 6A M1 P	2800852	1	
CB TM1 8A M1 P	2800853	1	
CB TM1 10A M1 P	2800854	1	
CB TM1 12A M1 P	2800855	1	
CB TM1 16A M1 P	2800856	1	

Bridge plug, 0 volt distribution	
<b>Base element</b>	
With push-in connection technology	
With screw connection technology	

Accessories		
Accessories	Order No.	Pcs. / Pkt.
CB PT BRIDGE	2801014	1
CB 1/6-2/4 PT-BE	2800929	10
CB 1/10-1/10 UT-BE	2801305	10

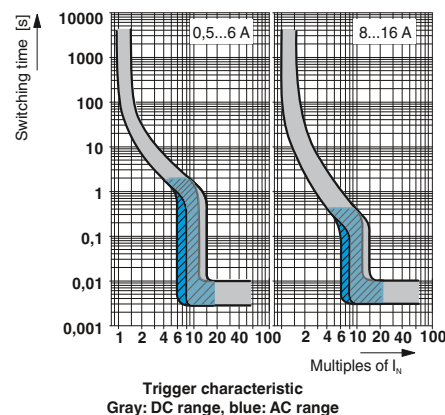



Can be plugged in, M1 characteristic curve, 2-pos.



Can be plugged in, F1 characteristic curve, 1-pos.



Can be plugged in, F1 characteristic curve, 2-pos.

Total width 24.6 mm

Total width 12.3 mm

Total width 24.6 mm

Technical data	
IEC	UL/CUL
240 V AC	277 V AC
80 V DC	80 V DC
Depends on the selected item version	
See trigger characteristic normal blow	
400 A (240 V AC) / 600 A (80 V DC)	
6000 (240 V AC/1 x I <sub>n</sub> )	
-30 °C ... 60 °C	
IP30 (Actuation area)	
EN 60934 / UL 1077 / UL 508 / CSA 22.2	

Technical data	
IEC	UL/CUL
240 V AC	277 V AC
50 V DC	50 V DC
Depends on the selected item version	
See trigger characteristic fast blow	
300 A (240 V AC) / 600 A (50 V DC)	
6000 (at 1 x I <sub>n</sub> )	
-30 °C ... 60 °C	
IP30 (Actuation area)	
EN 60934 / UL 1077 / UL 508 / CSA 22.2	

Technical data	
IEC	UL/CUL
240 V AC	277 V AC
80 V DC	80 V DC
Depends on the selected item version	
See trigger characteristic fast blow	
400 A (240 V AC) / 600 A (80 V DC)	
6000 (240 V AC/1 x I <sub>n</sub> )	
-30 °C ... 60 °C	
IP30 (Actuation area)	
EN 60934 / UL 1077 / UL 508 / CSA 22.2	

Ordering data		
Type	Order No.	Pcs. / Pkt.
CB TM2 0.5A M1 P	2800879	1
CB TM2 1A M1 P	2800880	1
CB TM2 2A M1 P	2800881	1
CB TM2 3A M1 P	2800882	1
CB TM2 4A M1 P	2800883	1
CB TM2 5A M1 P	2800884	1
CB TM2 6A M1 P	2800885	1
CB TM2 8A M1 P	2800886	1
CB TM2 10A M1 P	2800887	1
CB TM2 12A M1 P	2800888	1
CB TM2 16A M1 P	2800889	1

Ordering data		
Type	Order No.	Pcs. / Pkt.
CB TM1 0.5A F1 P	2800857	1
CB TM1 1A F1 P	2800858	1
CB TM1 2A F1 P	2800859	1
CB TM1 3A F1 P	2800860	1
CB TM1 4A F1 P	2800861	1
CB TM1 5A F1 P	2800862	1
CB TM1 6A F1 P	2800863	1
CB TM1 8A F1 P	2800864	1
CB TM1 10A F1 P	2800865	1
CB TM1 12A F1 P	2800866	1
CB TM1 16A F1 P	2800867	1

Ordering data		
Type	Order No.	Pcs. / Pkt.
CB TM2 0.5A F1 P	2800890	1
CB TM2 1A F1 P	2800891	1
CB TM2 2A F1 P	2800892	1
CB TM2 3A F1 P	2800893	1
CB TM2 4A F1 P	2800894	1
CB TM2 5A F1 P	2800895	1
CB TM2 6A F1 P	2800896	1
CB TM2 8A F1 P	2800897	1
CB TM2 10A F1 P	2800898	1
CB TM2 12A F1 P	2800899	1
CB TM2 16A F1 P	2800900	1

Accessories		
Accessories	Order No.	Pcs. / Pkt.
CB PT BRIDGE	2801014	1
CB 1/6-2/4 PT-BE	2800929	10
CB 1/10-1/10 UT-BE	2801305	10

Accessories		
Accessories	Order No.	Pcs. / Pkt.
CB PT BRIDGE	2801014	1
CB 1/6-2/4 PT-BE	2800929	10
CB 1/10-1/10 UT-BE	2801305	10

Accessories		
Accessories	Order No.	Pcs. / Pkt.
CB PT BRIDGE	2801014	1
CB 1/6-2/4 PT-BE	2800929	10
CB 1/10-1/10 UT-BE	2801305	10

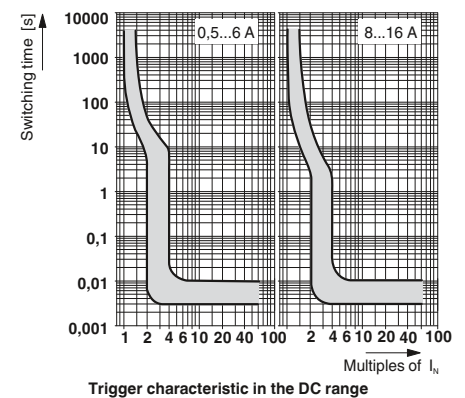
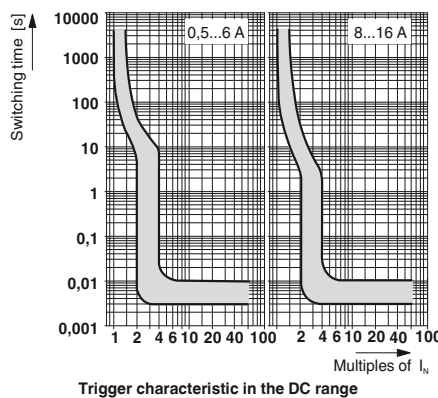
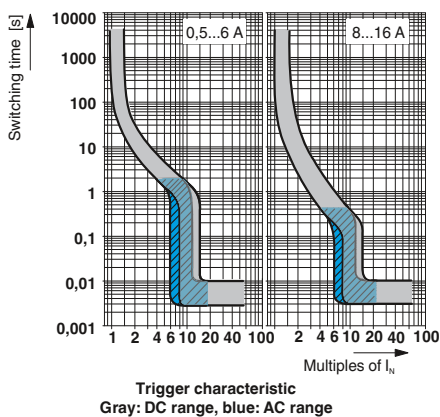

### Device circuit breaker board



- Reduced installation time thanks to multi-channel device circuit breaker board (4/8/12 channels)
- Space savings of up to 35% thanks to compact design
- Fuse protection of up to 12 A per channel provides best possible protection for connected loads
- Up to 5 loads can be protected simultaneously with the additional terminal points
- Integrated group remote signaling ensures that you are always kept informed
- High current carrying capacity of the board supports supply of up to 60 A
- Maximum overcurrent protection across long cable paths thanks to device circuit breakers with SFB trigger characteristic

Notes:
The board is supplied <b>without</b> a plug.
Only type CB TM1... plugs can be used.
For dimensional drawings, see <a href="http://www.phoenixcontact.net/products">www.phoenixcontact.net/products</a>

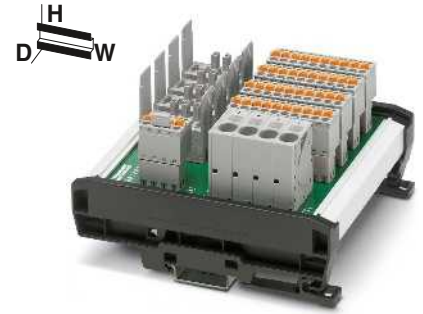

DIN-rail mountable

	Technical data		
	CBB TM 04	CBB TM 08	CBB TM 12
<b>Rated data</b>			
Rated voltage	Main circuit 24 V DC	24 V DC	24 V DC
	Remote indication circuit 24 V DC	24 V DC	24 V DC
Rated current $I_n$	Complete main circuit 12 A DC	60 A DC	60 A DC
	Main circuit per channel 12 A DC	12 A DC	12 A DC
	Remote indication circuit 1 A DC	1 A DC	1 A DC
Rated insulation voltage $U_i$	50 V DC	50 V DC	50 V DC
Rated surge voltage	0.5 kV	0.5 kV	0.5 kV
<b>General data</b>			
Dimensions W / H / D	118.5 mm / 127.8 mm / 72 mm	185.5 mm / 127.8 mm / 72 mm	252.5 mm / 127.8 mm / 72 mm
Ambient temperature (operation)	-30 °C ... 60 °C (At max. 45 A, see derating)	-30 °C ... 60 °C (At In 60 A)	-30 °C ... 60 °C (At In 60 A)
Degree of protection	IP20 (Terminal blocks and fuse holders) IP00 (PCB)		
Test standards	DIN EN 50178		
<b>Description</b>	<b>Device circuit breaker board</b> , for accommodating device circuit breakers		
	With 4 channels		
	With 8 channels		
	With 12 channels		
	<b>Ordering data</b>		
<b>Type</b>	<b>Order No.</b>	<b>Pcs. / Pkt.</b>	
CBB TM 04 2X2RC P-PT	2801481	1	
CBB TM 08 2X4RC P-PT	2801482	1	
CBB TM 12 2X6RC P-PT	2801483	1	



**Thermomagnetic circuit breaker  
UT 6-TMC ...**

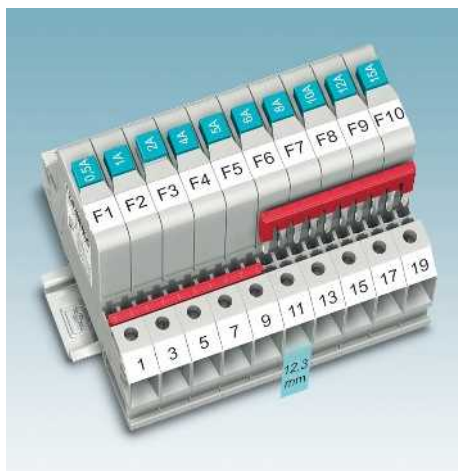

- Thermomagnetic circuit breakers feature a compact design, large-surface labeling options, and a double plug-in bridge shaft
- They can be integrated into the CLIPLINE complete system via the plug-in bridge shaft
- 12.3 mm compact design
- High level of system availability thanks to their reclosure function and clear status display
- Eleven nominal current levels can be selected from 0.5 A to 16 A
- Clear assignment of the relevant circuit breaker thanks to the large center labeling area

A complete data sheet is available to download for each product at [www.phoenixcontact.net/products](http://www.phoenixcontact.net/products).



DIN-rail mountable

UL, CE, RoHS, PC, A  
Total width 12.3 mm

Rated data	
Rated voltage	240 V AC
Rated voltage	28 V DC
Rated current $I_n$	Depends on the selected item version
Disconnection	
Switch-off time	See trigger characteristic
Fuse type	Normal blow (M1)
Rated short-circuit switching capacity $I_{cn}$	200 A (240 V AC) / 400 A (28 V DC)
Cycles, max.	6000 (at 1 x $I_n$ )
General data	
Dimensions W / H / D	12.3 mm / 85.5 mm / 89.5 mm
Connection method	Screw connection
Connection data solid / stranded / AWG	0.2 ... 10 mm <sup>2</sup> / 0.2 ... 10 mm <sup>2</sup> / 24 - 8
Stranded conductor cross section with ferrule	0.25 ... 6 mm <sup>2</sup>
Temperature range	-30 °C ... 60 °C
Degree of protection	IP40 (Actuation area) / IP20 (Connection area)
Standards/regulations	EN 60934 / UL 1077 / CSA 22.2

Technical data	
IEC	UL/CUL
240 V AC	240 V AC
28 V DC	28 V DC
Depends on the selected item version	
See trigger characteristic	
Normal blow (M1)	
200 A (240 V AC) / 400 A (28 V DC)	
6000 (at 1 x $I_n$ )	
12.3 mm / 85.5 mm / 89.5 mm	
Screw connection	
0.2 ... 10 mm <sup>2</sup> / 0.2 ... 10 mm <sup>2</sup> / 24 - 8	
0.25 ... 6 mm <sup>2</sup>	
-30 °C ... 60 °C	
IP40 (Actuation area) / IP20 (Connection area)	
EN 60934 / UL 1077 / CSA 22.2	

Description	Nominal current
Thermomagnetic circuit breaker, for mounting on NS 35...	
	0.5 A
	1 A
	2 A
	4 A
	5 A
	6 A
	8 A
	10 A
	12 A
	15 A
	16 A

Ordering data		
Type	Order No.	Pcs. / Pkt.
UT 6-TMC M 0,5A	0916603	6
UT 6-TMC M 1A	0916604	6
UT 6-TMC M 2A	0916605	6
UT 6-TMC M 4A	0916606	6
UT 6-TMC M 5A	0916607	6
UT 6-TMC M 6A	0916608	6
UT 6-TMC M 8A	0916609	6
UT 6-TMC M 10A	0916610	6
UT 6-TMC M 12A	0916611	6
UT 6-TMC M 15A	0916612	6
UT 6-TMC M 16A	0916613	6

Plug-in bridge, red	Number of positions
	2
	3
	4
	5
	10
	20
Warning label, for UT series	
Screwdriver	SZS 1,0x4,0 VDE
Lateral groove labeling	

Accessories		
	Order No.	Pcs. / Pkt.
FBS 2-6	3030336	50
FBS 3-6	3030242	50
FBS 4-6	3030255	50
FBS 5-6	3030349	50
FBS 10-6	3030271	10
FBS 20-6	3030365	10
WS UT 6	3047345	10
SZS 1,0x4,0 VDE	1205066	10

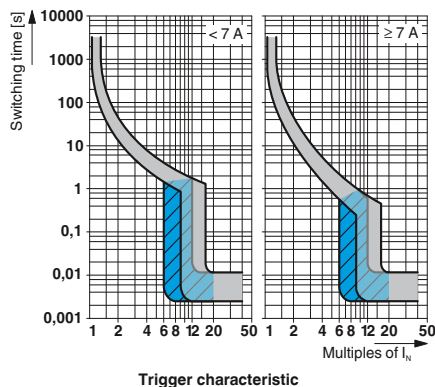

### TCP thermal circuit breaker



- Plug-in thermal miniature circuit breakers combine the protective mechanism of an auto flat-type fuse with the advantages of a circuit breaker
- In the event of an error, the time-sensitive search for a suitable replacement fuse is eliminated thanks to the reclosure function
- The area of application extends to the protection of integrated circuits in all battery and onboard systems with up to 32 V DC
- Fits in all fuse holders designed for flat-type fuse inserts according to ISO 8820-3 (DIN 72581-3)
- A version with screw or spring-cage connection is used as a basic terminal block

You can find more fuse terminal blocks in Catalog 3, Modular terminal blocks.

Notes:
Attention: The reset button must not be obstructed. During installation, please leave enough room for using button.
For additional technical data, drawings, and accessories, please visit <a href="http://www.phoenixcontact.net/products">www.phoenixcontact.net/products</a> .
You can find a wide selection of fuse terminal blocks in Catalog 3, Modular terminal blocks
1) If the fuse is faulty, the downstream circuit is not off load.

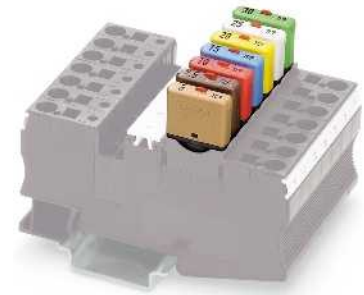

For fuse holder

Rated data
Rated voltage
Rated current $I_n$
Disconnection
Switch-off time
Fuse type
Rated short-circuit switching capacity $I_{cn}$
General data
Dimensions W / H / D
Height
Temperature range
Degree of protection

Total width 6 mm

Technical data
IEC
32 V DC
Depends on the selected item version
See trigger characteristic
Slow-blow
$\leq 50$ A (300 switch-offs)
6 mm / 20 mm / 31.2 mm
17 mm
-40 °C ... 85 °C
IP30 (Actuation area)

Description	Nominal current
<b>One-pos., thermal circuit breaker, for fuse holders in acc. with ISO 8820-3</b>	
	5 A
	7,5 A
	10 A
	15 A
	20 A
	25 A
	30 A
	40 A

Ordering data		
Type	Order No.	Pcs. / Pkt.
TCP 5/DC32V	0700005	50
TCP 7,5/DC32V	0700007	50
TCP 10/DC32V	0700010	50
TCP 15/DC32V	0700015	50
TCP 20/DC32V	0700020	50
TCP 25/DC32V	0700025	50
TCP 30/DC32V	0700030	50
TCP 40/DC32V	0700040	50

Fuse terminal block, with spring-cage connection, for mounting on NS 35...
With LED for 12 V DC, 1.7 mA
With LED for 24 V DC, 1.9 mA <sup>1)</sup>
Fuse terminal block, for mounting on NS 32... or NS 35...
With LED for 12 V DC
With LED for 24 V DC, 1.9 mA <sup>1)</sup>

Accessories		
Type	Order No.	Pcs. / Pkt.
ST 4-FSI/C	3036372	50
ST 4-FSI/C-LED 12	3036495	50
ST 4-FSI/C-LED 24	3036505	50
UK 6-FSI/C	3118203	50
UK 6-FSI/C-LED12	3001925	50
UK 6-FSI/C-LED24	3001938	50

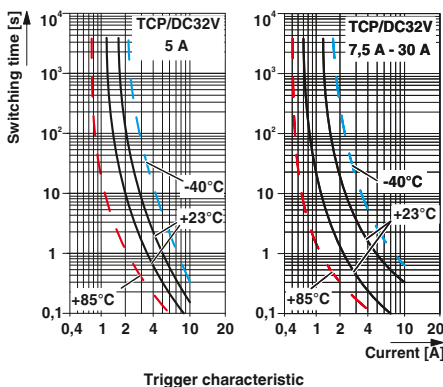

TCP thermal circuit breaker



**Notes:**

**Note:**  
When mounted in rows, the nominal current of the devices can be transmitted only at 80% or must be correspondingly overdimensioned.

For additional technical data, drawings, and accessories, please visit [www.phoenixcontact.net/products](http://www.phoenixcontact.net/products).



Can be plugged into a fuse terminal block

- The reclosable thermal circuit breaker is available in nine nominal current levels ranging from 0.25 to 10 A
  - The integrated switching function enables immediate reclosure and thus ensures the availability of the system
  - Compact design
  - A version with screw or spring-cage connection is used as a basic terminal block
  - Potential distribution possible by means of bridges
- A complete data sheet is available to download for each product at [www.phoenixcontact.net/products](http://www.phoenixcontact.net/products).

<b>Rated data</b>	Rated voltage Rated voltage Rated current $I_n$
<b>Disconnection</b>	Switch-off time Fuse type
<b>General data</b>	Dimensions W / H / D Temperature range Degree of protection

Total width 8.2 mm

<b>Technical data</b>	
IEC	250 V AC 65 V DC Depends on the selected item version
Disconnection	See trigger characteristic Slow-blow
General data	8.2 mm / 64 mm / 88.5 mm -20 °C ... 60 °C IP40 (Actuation area)

Description	Nominal current
<b>Thermal miniature circuit breaker, can be plugged into UK 6 FSI/C or ST 4-FSI/C fuse terminal block</b>	
	0.25 A
	0.5 A
	1 A
	2 A
	3 A
	4 A
	6 A
	8 A
	10 A

<b>Ordering data</b>		
Type	Order No.	Pcs. / Pkt.
TCP 0,25A	0712123	20
TCP 0,5A	0712152	20
TCP 1A	0712194	20
TCP 2A	0712217	20
TCP 3A	0712233	20
TCP 4A	0712259	20
TCP 6A	0712275	20
TCP 8A	0712291	20
TCP 10A	0712314	20

**Fuse terminal block, for mounting on NS 32... or NS 35...**

**Fuse terminal block, with spring-cage connection, for mounting on NS 35...**

<b>Accessories</b>		
Accessories	Order No.	Pcs. / Pkt.
UK 6-FSI/C	3118203	50
ST 4-FSI/C	3036372	50

**Lateral groove labeling**

For ZB 5, see page 111

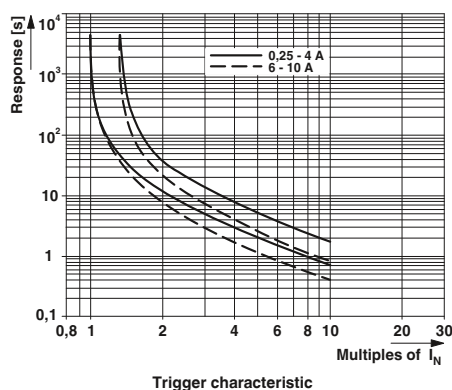

# Protective devices

## Device circuit breakers

### TMC thermomagnetic circuit breaker

- Available with fast-blow and medium-blow characteristic curve for various nominal current strengths
- Single or two-pos. main current path
- All TMCP ... plug-in thermomagnetic circuit breakers also have integrated signal contacts

<b>Notes:</b>
For additional technical data, drawings, and accessories, please visit <a href="http://www.phoenixcontact.net/products">www.phoenixcontact.net/products</a> .
1) Please observe the type key on the right side.
2) Main contact

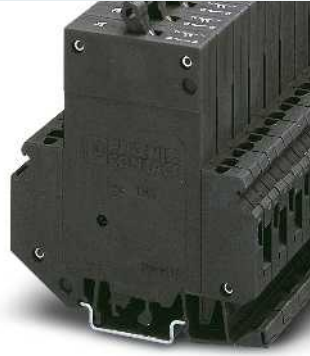

DIN-rail mountable



Can be plugged onto base

Total width 12.5 mm

#### Technical data

<b>Rated data</b>	IEC
Rated voltage	250 V AC
Rated voltage	65 V DC
Rated current I <sub>n</sub>	Depends on the selected item version
<b>Disconnection</b>	
Switch-off time	See trigger characteristic
Fuse type	Fast blow (F1)
Rated short-circuit switching capacity I <sub>cn</sub>	400 A / 2500 A (32 V DC)
<b>General data</b>	
Dimensions W / H / D	12.5 mm / 82.5 mm / 96 mm
Connection method	Screw connection
Connection data solid / stranded / AWG	0.2 ... 6 mm <sup>2</sup> / 0.2 ... 4 mm <sup>2</sup> / 24 - 10
Stranded conductor cross section with ferrule	0.25 ... 4 mm <sup>2</sup>
Temperature range	-30 °C ... 60 °C
Degree of protection	IP30 (Actuation area) / IP20 (Connection area)

Total width 12.5 mm

#### Technical data

<b>Rated data</b>	IEC
Rated voltage	250 V AC
Rated voltage	65 V DC
Rated current I <sub>n</sub>	Depends on the selected item version
<b>Disconnection</b>	
Switch-off time	See trigger characteristic
Fuse type	Fast blow (F1)
Rated short-circuit switching capacity I <sub>cn</sub>	400 A / 2500 A (32 V DC)
<b>General data</b>	
Dimensions W / H / D	38 mm / 115 mm / 121 mm
Connection method	plug-in
Connection data solid / stranded / AWG	-
Stranded conductor cross section with ferrule	-
Temperature range	-30 °C ... 60 °C
Degree of protection	IP30 (Actuation area) / IP00 (Connection area)

#### Ordering data

Description	Nominal current
<b>Thermomagnetic circuit breaker</b> , with universal foot for mounting on NS 32... or NS 35... <sup>1)</sup>	
<b>Thermomagnetic circuit breaker</b> , plug-in, one, two or three-position <sup>1)</sup>	

Type	Order No.	Pcs. / Pkt.
<b>TMC 1 F1 100 0,2A</b>	<b>0914015</b>	6

#### Ordering data

Type	Order No.	Pcs. / Pkt.
<b>TMCP 1 F1 300 0,2A</b>	<b>0915506</b>	6

#### Accessories

<b>Spring lock</b> , for mechanical locking in the case of overhead mounting, 1-pos.		
<b>Modular socket</b> , 2-position, for holding two circuit breakers, each with a single position		
<b>Socket termination elements</b> , can be plugged in both left and right, contain the connections for the reset inputs/group query		
<b>Signal bridge</b> , plug-in, for bridging group signaling when there is a free slot on the TMCP SOCKET M socket		



#### Accessories

<b>SPRING-LOCK</b>	<b>0713009</b>	10
<b>TMCP SOCKET M</b>	<b>0916589</b>	10
<b>TMCP CONNECT LR</b>	<b>0916592</b>	3
<b>TMCP SB</b>	<b>0916602</b>	6

### Multiplication factor for higher ambient temperatures for TCP..., UT 6-TMC..., TMC..., and TMCP..

Note:  
When mounted in rows with simultaneous load, a mutual thermal effect occurs. This is equivalent to a rise in the ambient temperature. It depends on the nominal current, the ambient temperature, the number of devices, and the distance between devices. The nominal device current can be either oversized (see multiplication factor for temperature behavior) or limited to just > 80%. Please request the maximum permissible current if planning to mount in rows.

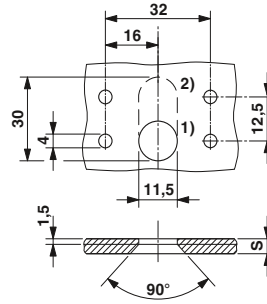
### Drilling diagram for front plate mounting of TMCP



S > 1,5 mm

1) 1-pos.

2) 2-pos.

Ambient temperature, °C	Multiplication factor
-30	0.76
-20	0.79
-10	0.83
0	0.93
+10	0.93
+23	1.00
+30	1.04
+40	1.11
+50	1.19
+60	1.29

### TMC and TMCP trigger characteristics

Medium-blow (M1): 0.2 - 6 A nominal value

Lower tripping limit: 1.05 I<sub>N</sub>  
Upper tripping limit: 1.4 I<sub>N</sub>

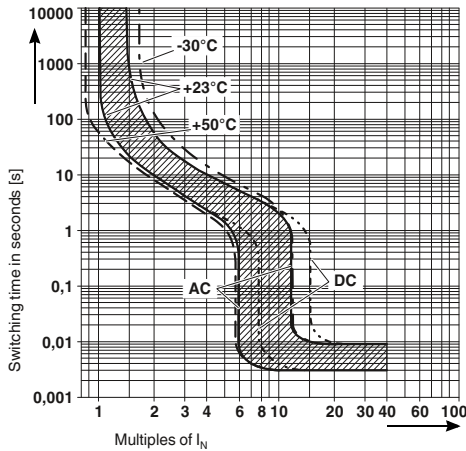

Medium-blow (M1): 8 - 16 A nominal value

Lower tripping limit: 1.05 I<sub>N</sub>  
Upper tripping limit: 1.4 I<sub>N</sub>

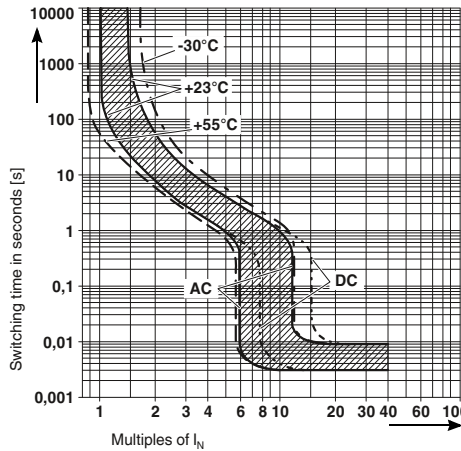

Fast-blow (F1): 0.2 - 16 A nominal value

#### Only for DC applications

Lower tripping limit: 1.05 I<sub>N</sub>  
Upper tripping limit: 1.4 I<sub>N</sub>

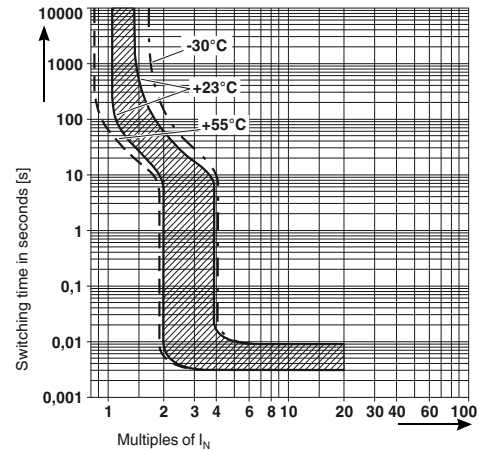

### TMC and TMCP type keys

The type key indicates the unique structure of the product.

Type	Main current paths	Characteristic curve	Auxiliary contact versions	Nominal current
TMC or TMCP	1 ≙ Single-pos. 2 ≙ Two-pos. 3 ≙ Three-pos.	F1 ≙ Therm. 1.05 - 1.4 I <sub>N</sub> , magn. 2 - 4 I <sub>N</sub> DC (fast-blow), <b>Only for DC applications</b> M1 ≙ Therm. 1.05 - 1.4 I <sub>N</sub> , magn. 6 - 12 I <sub>N</sub> AC, 7.8 - 15.6 I <sub>N</sub> DC (medium-blow)	100 ≙ Single-pos.: 1 N/O contact 200 ≙ Single-pos.: 1 N/C contact 120 ≙ Two-pos.: 1 N/O contact, 1 N/C contact 122 ≙ Three-pos.: 1 N/O contact, 2 N/C contacts 300 <sup>4)</sup> ≙ 1 N/O contact and 1 N/C contact per position	0.2 A 2.5 A 0.3 A 3 A 0.4 A 4 A 0.5 A 5 A 0.6 A 6 A 0.8 A 8 A 1 A 10 A 1.5 A 12 A 2 A 16 A

### Ordering example:

TMC with single-pos. main current path, one N/O contact, medium-blow characteristic curve, and a nominal current of 2 A.

TMC	1	M1	100	2 A
-----	---	----	-----	-----

<sup>4)</sup> Only version for TMCP, cannot be used for TMC.

# Protective devices

## Device circuit breakers

### EC-E1 and EC-E4 electronic circuit breakers

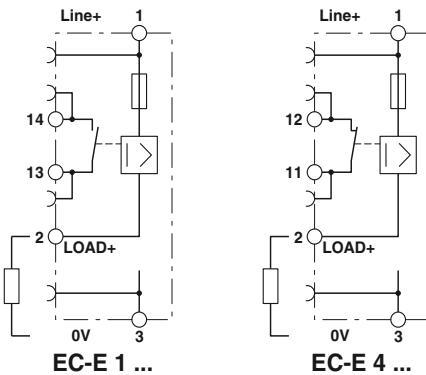

With signal contact as N/C contact or N/O contact

- Selective protection of all 24 V DC load circuits at switched-mode power supply units
  - A combination of active electronic current limitation in the event of short circuit and overload shutdown ensures that the circuit breaker can respond to overloads faster than the switched-mode power supply unit
  - The residual current is always limited to 1.3 - 1.8 times the nominal current
- A complete data sheet is available to download for each product at [www.phoenixcontact.net/products](http://www.phoenixcontact.net/products).

**Notes:**  
For additional technical data, drawings, and accessories, please visit [www.phoenixcontact.net/products](http://www.phoenixcontact.net/products).

<b>Rated data</b>
Operating voltage
Rated current $I_n$
<b>Disconnection</b>
Switch-off time
Fuse type
<b>General data</b>
Dimensions W / H / D
Connection method
Connection data solid / stranded / AWG
Stranded conductor cross section with ferrule
Temperature range
Degree of protection
Inflammability class according to UL 94

UL IEC  
Total width 12.5 mm

Technical data	
IEC	24 V DC
Depends on the selected item version	
See trigger characteristic	
Electronic	
12.5 mm / 83 mm / 80 mm	
Screw connection	
0.5 ... 16 mm <sup>2</sup> / 0.5 ... 16 mm <sup>2</sup> / 20 - 6	
0.5 ... 10 mm <sup>2</sup>	
0 °C ... 50 °C (without condensation)	
IP20 (Housing)	
V0	

Description	Nominal current
<b>Electronic circuit breaker, signal contact: 1 N/O contact</b>	
	0.5 A
	1 A
	2 A
	3 A
	4 A
	6 A
	8 A
	10 A
	12 A
<b>Electronic circuit breaker, signal contact: 1 N/C contact</b>	
	0.5 A
	1 A
	2 A
	3 A
	4 A
	6 A
	8 A
	10 A
	12 A

Ordering data		
Type	Order No.	Pcs. / Pkt.
EC-E1 0,5A	0903022	6
EC-E1 1A	0903023	6
EC-E1 2A	0903024	6
EC-E1 3A	0903025	6
EC-E1 4A	0903026	6
EC-E1 6A	0903028	6
EC-E1 8A	0903029	6
EC-E1 10A	0903030	6
EC-E1 12A	0903031	6
EC-E4 0,5A	0903040	6
EC-E4 1A	0903032	6
EC-E4 2A	0903033	6
EC-E4 3A	0903034	6
EC-E4 4A	0903035	6
EC-E4 6A	0903036	6
EC-E4 8A	0903037	6
EC-E4 10A	0903038	6
EC-E4 12A	0903039	6

<b>Cont. plug-in bridge</b> , 500 mm long, isolated, can be cut to length, for potential distribution
Nominal current: 32 A
<b>Screwdriver</b>
<b>Lateral groove labeling</b>

Accessories		
FBST 500-PLC BU	2966692	20
FBST 500-PLC RD	2966786	20
FBST 500 TMC-N GY	0901028	10
SZS 0,6X3,5	1205053	10

For ZBF 12, see page 111

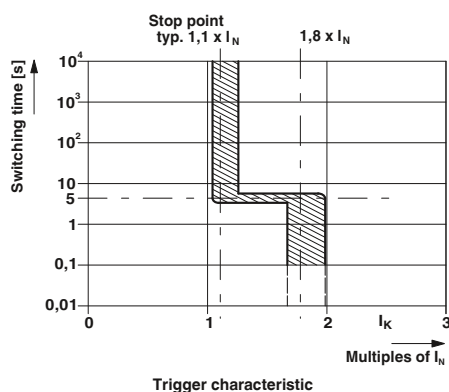

EC-E electronic circuit breakers



- Selective protection of all 24 V DC load circuits at switched-mode power supply units
  - A combination of active electronic current limitation in the event of short circuit and overload shutdown ensures that the circuit breaker can respond to overloads faster than the switched-mode power supply unit
  - The residual current is always limited to 1.3 - 1.8 times the nominal current
- A complete data sheet is available to download for each product at [www.phoenixcontact.net/products](http://www.phoenixcontact.net/products).

**Notes:**  
For additional technical data, drawings, and accessories, please visit [www.phoenixcontact.net/products](http://www.phoenixcontact.net/products).

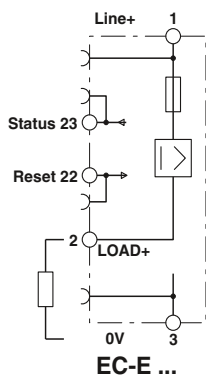

With reset input and status output



Total width 12.5 mm

Technical data

IEC  
24 V DC  
Depends on the selected item version

See trigger characteristic  
Electronic

Dimensions W / H / D  
12.5 mm / 83 mm / 80 mm  
Connection method  
Screw connection  
Connection data solid / stranded / AWG  
0.5 ... 16 mm<sup>2</sup> / 0.5 ... 16 mm<sup>2</sup> / 26 - 6  
0.5 ... 10 mm<sup>2</sup>  
Temperature range  
0 °C ... 50 °C (without condensation)  
Degree of protection  
IP20 (Housing)  
Inflammability class according to UL 94  
V0

Ordering data

Description	Nominal current	Type	Order No.	Pcs. / Pkt.
<b>Electronic circuit breaker, with reset input</b>				
	0.5 A	EC-E 0.5A DC24V	0903041	6
	1 A	EC-E 1A DC24V	0903042	6
	2 A	EC-E 2A DC24V	0903043	6
	3 A	EC-E 3A DC24V	0903044	6
	4 A	EC-E 4A DC24V	0903045	6
	6 A	EC-E 6A DC24V	0903046	6
	8 A	EC-E 8A DC24V	0903047	6
	10 A	EC-E 10A DC24V	0903048	6
	12 A	EC-E 12A DC24V	0903049	6

Accessories

<b>Cont. plug-in bridge, 500 mm long, isolated, can be cut to length, for potential distribution</b>		
Nominal current: 32 A		
	<b>FBST 500-PLC BU</b>	2966692 20
	<b>FBST 500-PLC RD</b>	2966786 20
	<b>FBST 500 TMC-N GY</b>	0901028 10

Lateral groove labeling

For ZBF 12, see page 111

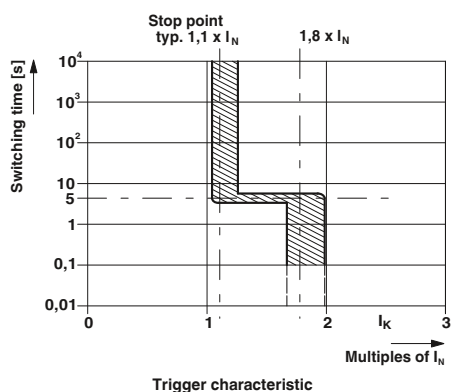

## Device circuit breakers

### ECP-E plug-in electronic circuit breaker

The area of application for the electronic circuit-breaker ECP-E extends to all aspects connected with the power supply unit. In the event of an overload, power supply units reduce their output voltage and all the connected loads are no longer supplied with sufficient power, e.g., in the case of short-circuit at the load.

The solution here is the electronic circuit breaker:

- Selective protection of all 24 V DC load circuits at switched-mode power supply units
- Residual current always limited to 1.8 times the nominal current
- Capacitive loads can be switched on and loads are only switched off in the event of an overload or short circuit

After detecting overload or short-circuit in the load circuit, the load output of the ECP-E is locked. The current flow is interrupted in the faulty current circuit. The ECP-E and subsequently the current circuit can be activated again through the electronic reset input (13;14) or manually at the device through the slide-type switch.

The ECP-E has the following features:

- The operating or error state is indicated by a multi-color LED as well as an integrated status output (12)
- Design width of just 12.5 mm
- Can be plugged onto TMCP SOCKET M base

A complete data sheet is available to download for each product at

[www.phoenixcontact.net/products](http://www.phoenixcontact.net/products).

#### Notes:

For additional technical data, drawings, and accessories, please visit [www.phoenixcontact.net/products](http://www.phoenixcontact.net/products).

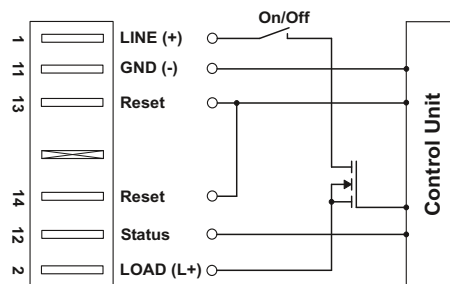

With reset input and status output



Total width 12.5 mm

#### Technical data

IEC  
24 V DC  
Depends on the selected item version

See trigger characteristic  
Electronic

38 mm / 115 mm / 112.5 mm  
0 °C ... 50 °C (without condensation)  
IP30 (Actuation area)  
V0

#### Ordering data

Description	Nominal current
<b>Electronic circuit breaker</b> , standard variant with status output and reset input, can be plugged into TMCP socket, signaling through three-color LED	
	1 A
	2 A
	3 A
	4 A
	6 A
	8 A
	10 A
	12 A

Type	Order No.	Pcs. / Pkt.
ECP-E 1A	0900113	5
ECP-E 2A	0900210	5
ECP-E 3A	0900317	5
ECP-E 4A	0900414	5
ECP-E 6A	0900618	5
ECP-E 8A	0900812	5
ECP-E 10A	0901002	5
ECP-E-12A	0900126	5

#### Accessories

**Modular socket**, 2-position, for holding two circuit breakers, each with a single position

**Socket termination elements**, can be plugged in both left and right, contain the connections for the reset inputs/group query

TMCP SOCKET M	0916589	10
TMCP CONNECT LR	0916592	3

#### Lateral groove labeling

ZB 6, see page 111

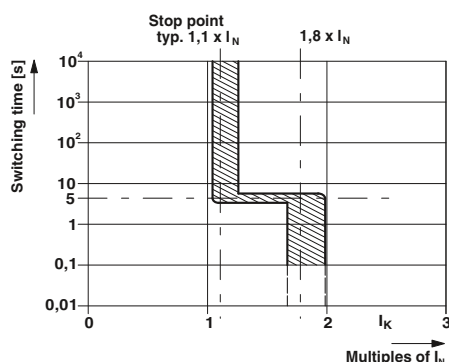



**ECP-E2 plug-in electronic circuit breaker**

- Area of application covers all aspects of the switched-mode power supply unit
- Includes the advantages of current limitation
- Responds faster than switched-mode power supply unit to overload and short circuit
- Output voltage of switched-mode power supply unit remains stable
- Sufficient supply of all error-free load circuits
- In addition, the ECP-E2 can be controlled remotely by the control input (12), e.g., by means of a PLC

**Notes:**  
For additional technical data, drawings, and accessories, please visit [www.phoenixcontact.net/products](http://www.phoenixcontact.net/products).

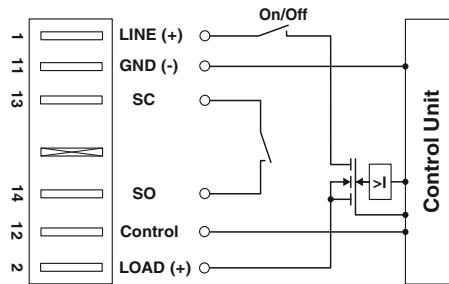

With control input and group request

**UL**  
Total width 12.5 mm

Rated data	
Operating voltage	24 V DC
Rated current $I_n$	Depends on the selected item version
Disconnection	
Switch-off time	See trigger characteristic
Fuse type	Electronic
General data	
Dimensions W / H / D	38 mm / 115 mm / 112.5 mm
Temperature range	0 °C ... 50 °C (without condensation)
Degree of protection	IP30 (Actuation area)
Inflammability class according to UL 94	V0

Technical data	
IEC	24 V DC
Depends on the selected item version	
See trigger characteristic	
Electronic	
38 mm / 115 mm / 112.5 mm	
0 °C ... 50 °C (without condensation)	
IP30 (Actuation area)	
V0	

Description	Nominal current
<b>Electronic circuit breaker</b> , variant with control input and group query, can be plugged into TMCP socket, signaling through three-color LED	
	1 A
	2 A
	3 A
	4 A
	6 A
	8 A
	10 A
	12 A

Ordering data			
Type	Order No.	Pcs. / Pkt.	
ECP-E2-1A	0900139	5	
ECP-E2-2A	0900236	5	
ECP-E2-3A	0900333	5	
ECP-E2-4A	0900430	5	
ECP-E2-6A	0900634	5	
ECP-E2-8A	0900838	5	
ECP-E2-10A	0900100	5	
ECP-E2-12A	0900207	5	

**Modular socket**, 2-position, for holding two circuit breakers, each with a single position

Accessories		
<b>TMCP SOCKET M</b>	0916589	10
<b>TMCP CONNECT LR</b>	0916592	3

**Socket termination elements**, can be plugged in both left and right, contain the connections for the reset inputs/group query

**Lateral groove labeling**

ZB 6, see page 111

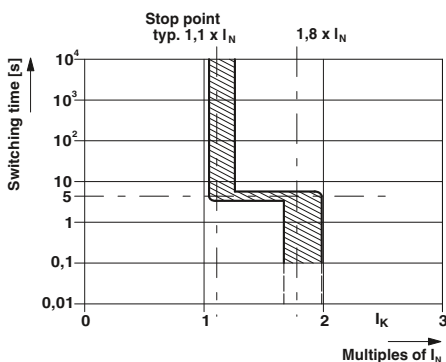

### ECP-E3 electronic circuit breaker

- Area of application covers all aspects of the switched-mode power supply unit
- Includes the advantages of current limitation
- Responds faster than switched-mode power supply unit to overload and short circuit
- Output voltage of switched-mode power supply unit remains stable
- Sufficient supply of all error-free load circuits
- In addition, the ECP-E3 can be restarted by the reset input (12), e.g., by means of a PLC

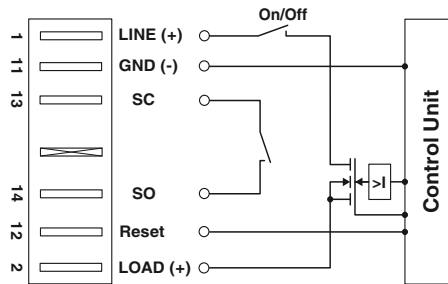

With reset input and group query

**Notes:**  
For additional technical data, drawings, and accessories, please visit [www.phoenixcontact.net/products](http://www.phoenixcontact.net/products).

Rated data	
Operating voltage	24 V DC
Rated current $I_n$	Depends on the selected item version
Disconnection	
Switch-off time	See trigger characteristic
Fuse type	Electronic
General data	
Dimensions W / H / D	38 mm / 115 mm / 112.5 mm
Temperature range	0 °C ... 50 °C (without condensation)
Degree of protection	IP30 (Actuation area)
Inflammability class according to UL 94	V0



Total width 12.5 mm

Technical data	
IEC	24 V DC
IEC	Depends on the selected item version
See trigger characteristic	Electronic
Dimensions W / H / D	38 mm / 115 mm / 112.5 mm
Temperature range	0 °C ... 50 °C (without condensation)
Degree of protection	IP30 (Actuation area)
Inflammability class according to UL 94	V0

Description	Nominal current
<b>Electronic circuit breaker</b> , variant with control input and group query, can be plugged into TMCP socket, signaling through three-color LED	
	1 A
	2 A
	3 A
	4 A
	6 A
	8 A
	10 A
	12 A

Ordering data		
Type	Order No.	Pcs. / Pkt.
ECP-E3 1A	0912041	5
ECP-E3 2A	0912042	5
ECP-E3 3A	0912043	5
ECP-E3 4A	0912044	5
ECP-E3 6A	0912046	5
ECP-E3 8A	0912048	5
ECP-E3 10A	0912050	5
ECP-E3 12A	0912052	5

**Modular socket**, 2-position, for holding two circuit breakers, each with a single position

**Socket termination elements**, can be plugged in both left and right, contain the connections for the reset inputs/group query

Accessories		
Accessories	Order No.	Pcs. / Pkt.
TMCP SOCKET M	0916589	10
TMCP CONNECT LR	0916592	3

**Lateral groove labeling**

ZB 6, see page 111

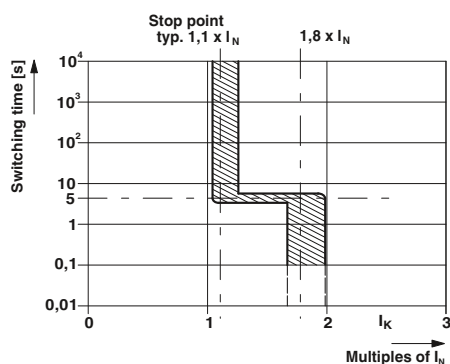

ECP selective circuit breaker

The area of application for the ECP ... extends to all aspects of the power supply unit. In the case of an overload, power supply units reduce the output voltage. As a consequence, all connected loads would no longer be sufficiently supplied. This means that if an error occurs in one load of a system, the voltage will be affected in all load circuits.

The solution here is the electronic circuit breaker:

- Selective protection of all 24 V DC load circuits at switched-mode power supply units
  - Residual current always limited to 1.8 times the nominal current
  - Combination of active electronic current limitation and proven circuit breaker technology including electrical isolation
  - Capacitive loads can be switched on and loads are only switched off in the event of an overload or short circuit
- Other properties:
- Operating or error state indicated by LED and integrated signal contacts
  - Design width of just 12.5 mm
  - Can be plugged onto TMCP SOCKET M base

A complete data sheet is available to download for each product at [www.phoenixcontact.net/products](http://www.phoenixcontact.net/products).

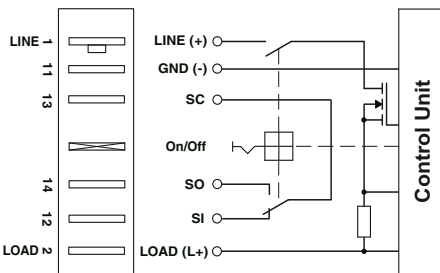

Can be plugged onto base



Total width 12.5 mm

Technical data

IEC  
24 V DC  
Depends on the selected item version

See trigger characteristic  
Electronic

38 mm / 115 mm / 147.5 mm  
0 °C ... 50 °C (without condensation)  
IP30 (Actuation area)  
V0

**Rated data**  
Operating voltage  
Rated current  $I_n$

**Disconnection**  
Switch-off time  
Fuse type

**General data**  
Dimensions W / H / D  
Temperature range  
Degree of protection  
Inflammability class according to UL 94

Ordering data

Description	Nominal current	Type	Order No.	Pcs. / Pkt.
<b>Selective circuit breaker</b> , can be plugged into TMCP base, signaling using two-color LED, floating signal contact, on/off pushbutton	2 A	ECP 2	0911034	5
	3 A	ECP 3	0911047	5
	4 A	ECP 4	0912034	5
	6 A	ECP 6	0912033	5
	8 A	ECP 8	0912019	5
	10 A	ECP 10	0912020	5
<b>Selective circuit breaker</b> , as above, but nominal current can be set via a switch, 1 A and 2 A	1 A (Adjustable)	ECP 1-2	0912018	5
<b>Selective circuit breaker</b> , as above, but nominal current can be set via a switch, 3 A and 6 A	3 A (Adjustable)	ECP 3-6	0916536	5

Accessories

Description	Order No.	Pcs. / Pkt.
<b>Modular socket</b> , 2-position, for holding two circuit breakers, each with a single position		
<b>Socket termination elements</b> , can be plugged in both left and right, contain the connections for the reset inputs/group query		
<b>Spring lock</b> , for mechanical locking in the case of overhead mounting, 1-pos.		
<b>TMCP SOCKET M</b>	0916589	10
<b>TMCP CONNECT LR</b>	0916592	3
<b>ECP-LOCK</b>	0912021	10
<b>Lateral groove labeling</b>	ZB 6, see page 111	

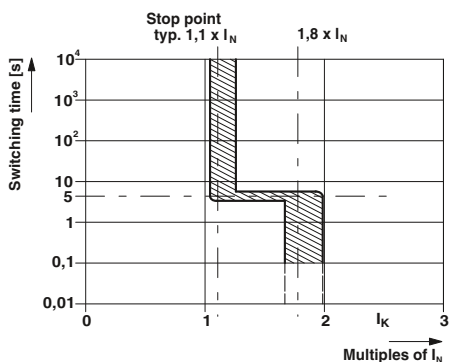

### Base for ECP and TMCP



- The TMCP SOCKET M base element is used to mount TMCP ... and ECP ... plug-in circuit breakers on DIN rails
- Flexible structure with any number of positions
- Individual protection thanks to free combination of both circuit breaker types on a single module
- The TMCP CONNECT LR termination elements are plugged in at the start and end of the module structure
- Supply indicated via connections 11 and 12
- Separate signal request for each circuit breaker
- Using connections 13 and 14 in the termination elements, a signal loop can be created via all circuit breakers quickly and without the need for additional wiring.
- All electrical connections of the main and signal contacts are located in the base
- Potential distribution possible by means of bridges
- User-friendly spring-cage connection
- Large-surface labeling options make it easier to assign the circuit breakers to the modules

#### Notes:

For additional technical data, drawings, and accessories, please visit [www.phoenixcontact.net/products](http://www.phoenixcontact.net/products).



To accommodate single-position circuit breakers



Total width 25 mm

#### Technical data

Dimensions W / H / D  
25 mm / 115 mm / 110.5 mm  
Connection method  
Spring-cage connection  
Connection data solid / stranded / AWG  
1.5 ... 10 mm<sup>2</sup> / 1.5 ... 10 mm<sup>2</sup> / 15 - 7

#### Ordering data

Type	Order No.	Pcs. / Pkt.
TMCP SOCKET M	0916589	10

#### Accessories

TMCP CONNECT LR	0916592	3
TMCP SB	0916602	6
FBST 500 TMCP	0916615	20
FBST 500-PLC BU	2966692	20
FBST 500-PLC RD	2966786	20

#### General data

Dimensions W / H / D  
Connection method  
Connection data solid / stranded / AWG

#### Description

**Modular socket**, 2-position, for holding two circuit breakers, each with a single position

**Socket termination elements**, can be plugged in both left and right, contain the connections for the reset inputs/group query

**Signal bridge**, plug-in, for bridging group signaling when there is a free slot on the TMCP SOCKET M, nominal current: 1 A

**Fixed bridge**, plug-in, 500 mm long, can be cut to length, for distribution of the input potential in the socket, nominal current: 50 A

**Continuous plug-in bridge**, 500 mm long, can be cut to length, for potential distribution, nominal current: 32 A

**Continuous plug-in bridge**, 500 mm long, can be cut to length, for potential distribution, nominal current: 32 A

Nominal current: 32 A

#### Lateral groove labeling

ZB 6, see page 111

**Backup fuse**

A backup fuse together with a circuit breaker must always be used if there is a risk of the maximum switching capacity being exceeded in the event of a fault. The adjacent table specifies the maximum switching current, the respective internal resistance and the resulting backup fuse.

TMCP and TMC nominal currents, internal resistances and backup fuses

Nominal current [A]	Maximum backup fuse [A]	Internal resistance [Ω]		Switching capacity as per EN 60934 [A]
		F1 (fast blow) for DC	M1 (normal blow) for DC/AC	
0.2	Any	39.3	26.1	400
0.3	Any	17.5	11.6	400
0.4	Any	9.2	6.6	400
0.5	Any	6.8	4.1	400
0.6	Any	4.2	3	400
0.8	Any	2.8	1.65	400
1	Any	1.6	1.10	400
1.5	25	0.78	0.47	400
2	25	0.42	0.28	400
2.5	25	0.26	0.183	400
3	25	0.18	0.124	400
4	25	0.12	0.077	400
5	25	0.092	0.063	400
6	50	0.054	0.045	800
8	50	0.025	≤ 0.02	800
10	50	0.022	≤ 0.02	800
12	50	≤ 0.02	≤ 0.02	800
16	50	≤ 0.02	≤ 0.02	800

TMCP circuit diagram

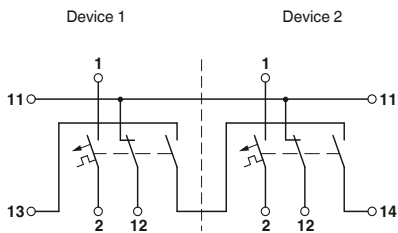

Display and definitions in the switched-off, zero-current state.

### Installation instructions for surge protective devices

#### Installation direction:

Surge protective devices with a multi-stage configuration which are looped into the circuit are marked “IN” and “OUT”. They must be connected before the device to be protected so that “IN” points towards the direction from which the surge voltage is expected.

The device to be protected should be connected to the terminal points marked “OUT”. This is the only way to ensure correct operation of the surge protective device in the event of a surge voltage coupling.

#### Connection:

The protective conductor connection of the system to be protected should be connected directly and via the shortest route to the ground connection of the surge protective device or the corresponding connection terminal block on the “OUT” side of the surge protective device.

This is the only way to ensure that impermissibly high voltages due to potential increases caused by discharge currents are prevented between the ground connections of the surge protective device and the device to be protected. The same is true for the connection between ground and the live conductors of the device to be protected (see figure: ground connection).

#### Equipotential bonding:

Correct operation of the surge protective devices requires complete equipotential bonding in accordance with the applicable regulations.

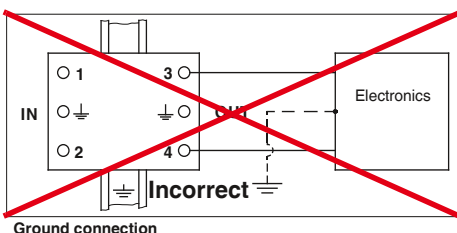
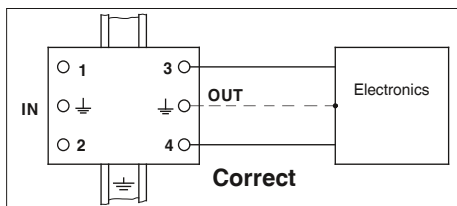

#### Cable routing:

Protected and unprotected cables must not be laid directly parallel to one another. They must be physically separated or shielded from one another so that surge voltages cannot be coupled from unprotected cables to protected ones. If crossed, cables that can influence one another must be crossed at right angles.

#### Quenching follow currents:

Gas-filled surge arresters only have limited self-quenching capability and are therefore almost always suitable for protecting message transmission systems.

The arresters easily meet the requirements of the usually high-impedance remote indication circuits. Distinct quenching behavior is observed under the following conditions in the case of systems with higher operating voltage or lower impedance:

**AC application:** if the possible short-circuit current of the source exceeds the alternating current carrying capacity, a fuse is required to prevent overheating caused by the follow current.

**DC application:** for voltages > 12 V DC, the possible short-circuit current of the source must not exceed 100 mA. Otherwise a fuse that enables shutdown within 5 seconds should be selected. Self-quenching capability is ensured for voltages ≤ 12 V. Please note, however, that the specific technical data for the product must always be observed.

**Backup fuse:** the system must be protected against impermissibly high short-circuit currents due to arrester overload. The maximum permissible or required backup fuse for the affected arrester is documented in the technical data of the relevant product.

### Surge voltage limiting components

The main function-specific components for lightning arresters and surge protective devices are spark gaps, gas-filled surge arresters, varistors, and diodes, as well as decoupling impedances.

All components have specific advantages and disadvantages. In order to achieve optimum protection, protective circuits and multi-stage protection concepts that combine various components can be implemented.

#### Suppressor diode

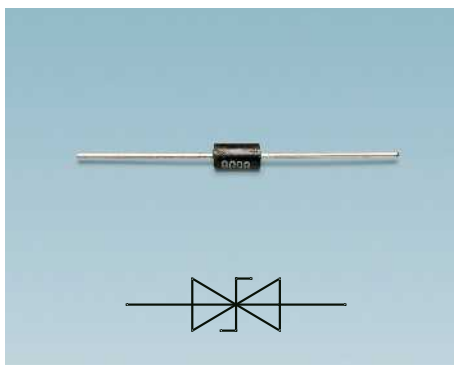

The reverse voltage  $U_R$  is the highest voltage that the diode can safely block. A current of 1 mA flows through the suppressor diode at the breakdown voltage  $U_B$ . At this point the suppressor diode starts limiting the surge voltage.

The maximum clamping voltage  $U_C$  is the highest voltage which can be present at the suppressor diode in the event of a peak pulse current  $I_{pp}$  (10/1000)  $\mu$ s.

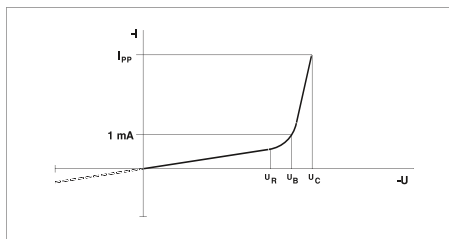

U/I characteristic curve of a suppressor diode  
Explanation:

- $U_R$  = Reverse voltage
- $U_B$  = Breakdown voltage
- $U_C$  = Clamping voltage
- $I_{pp}$  = Peak pulse current
- $I_R$  = Reverse current

**Varistors**

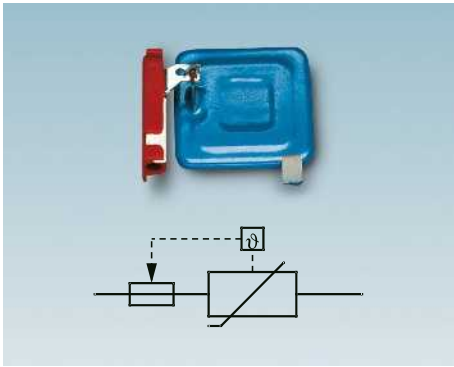

Block varistor with thermal disconnect device

Varistors are “voltage-dependent resistors” which, due to their voltage/current characteristic curves enable a high discharge capacity with a low residual voltage.

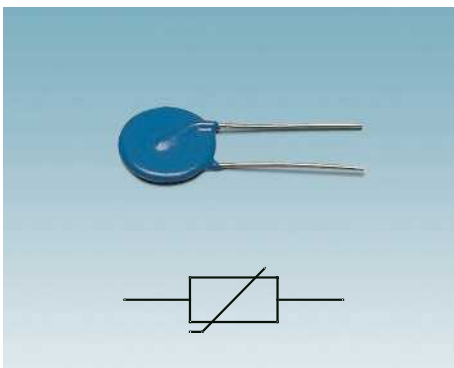

Disc varistor

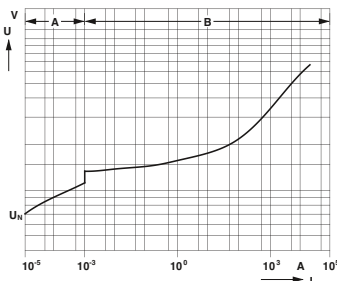

U/I characteristic curve of metal oxide varistors

Explanation:

- A = High-resistance operating area
- B = Low-resistance operating area/limiting area

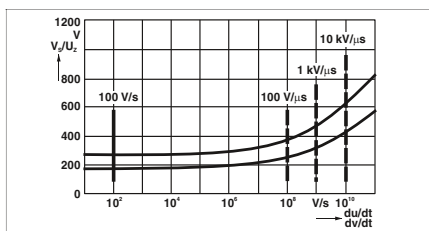

Characteristic ignition curve of a gas-filled surge arrester

- Static response behavior
- ■ ■ Dynamic response behavior

**Gas-filled surge arresters**

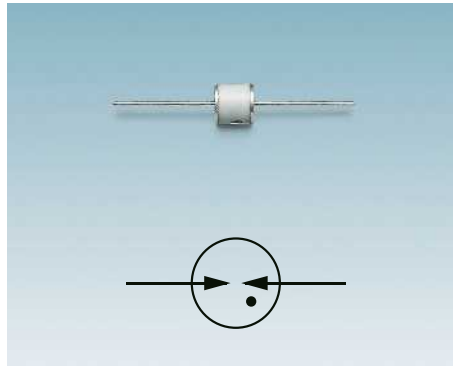

Gas-filled surge arresters consist of an electrode arrangement in a ceramic or glass tube. Between the electrodes is an inert gas, such as argon or neon. When the igniting voltage is reached, the component changes to a low-resistance state as a result of the gas discharge used. The igniting voltage is not a constant, instead it is dependent on the rate of rise of the surge voltage.

After igniting the discharge path, an arc voltage between 10 and 30 V typically occurs, which can be measured as a voltage drop at the arrester. In this low-resistance state, a line follow current, whose value depends on the impedance of the mains connected upstream, can flow through the arrester. In order to interrupt line follow currents that exceed the self-quenching capability, a fuse must be connected upstream of the surge arrester. Series connection of varistors or resistors is also possible.

The ArC spark gap in the FLASHTRAB lightning arrester is based on arc chopping technology. Two spark horns positioned opposite one another are kept at a distance by an isolator bridge bar. In addition, a baffle plate is fitted below the electrodes in the direction of the opening. In the event of a surge voltage, surface discharge occurs along the isolator bridge bar, which creates an arc. This is driven along the spark horns towards the baffle plate where it is chopped up. The resulting physical effects quench the arc and the associated line follow currents.

A significant increase in the follow current quenching capacity can be achieved with spark gap types in which quenching plates are arranged around the spark horns.

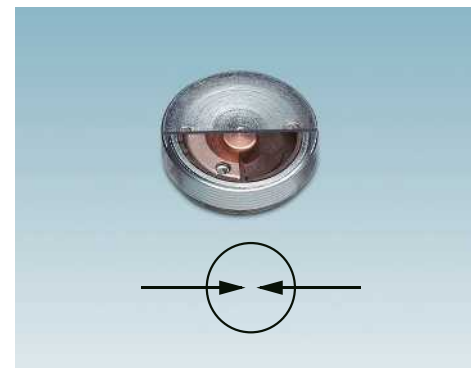

Encapsulated ArC spark gap

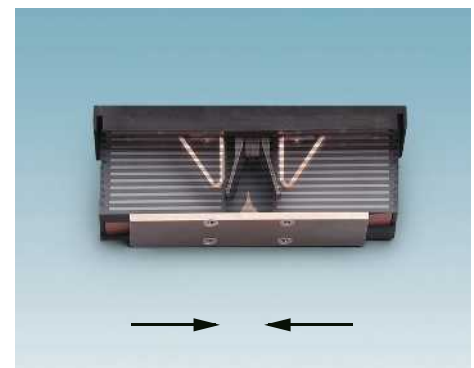

ArC spark gap with quenching plates

**Spark gaps**

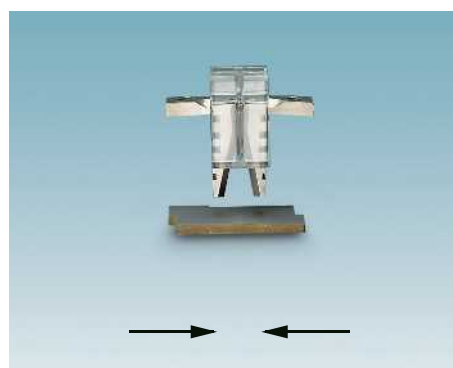

ArC spark gap

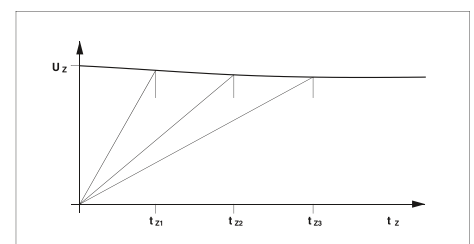

Characteristic ignition curve of a spark gap

### Surge protective devices

The wide range of different applications also requires numerous different surge protective devices with application-specific properties. Important criteria include the type of circuit, the surge-voltage limiting properties, and the design. The TRABTECH range from Phoenix Contact offers numerous versions, such as adapters, junction boxes or DIN-rail-mountable arresters in a modular and compact design, providing practical system solutions for all applications.

In line with their intended application, surge protective devices are designed for high electrical loads. However, excessive or very frequent surge voltages may lead to overload. This can result in a reduction or even failure of the protective function, and the affected protective device having to be replaced. Where possible, surge protective devices should therefore have a plug-in design and support testing.

The TRABTECH product range from Phoenix Contact takes these requirements into consideration as far as modern technology permits. The product range includes surge protective devices in the form of adapters, as well as devices with a two-piece plug-in modular design.

The protective devices in the FLASHTRAB, VALVETRAB, PLUGTRAB, and COMTRAB product ranges are particularly interesting with regard to their plug-in capability and testability. They have been developed with various protective circuits and different nominal voltages for applications in power supply, measurement and control, and data interface protection.

With components that are perfectly designed to work together, i.e., gas-filled surge arresters, varistors, and suppressor diodes depending on the protective circuit, their specific advantages are fully utilized.

### Explanation of terms

#### AC withstand voltage

The r.m.s. value of the highest sinusoidal voltage at mains frequency which will not lead to a disruptive discharge under the specified test conditions.

#### Aging

Modification of the original performance data due to disturbing pulses, operation or unfavorable ambient conditions.

#### Ambient conditions

The immediate ambient conditions for the device or the relevant air and creepage distances.

#### Arc voltage $U_{\text{a}}$

The arc voltage is the instantaneous value of the voltage on a discharge path (arc discharge) during an arresting process.

#### Arrester

Item of equipment that mainly consists of voltage-dependent resistors and/or spark gaps. Both elements can be connected in series or in parallel, or even used individually. Arresters are used to protect other electrical equipment and electrical systems against impermissibly high surge voltages.

#### Associated electrical equipment

An item of electrical equipment in which not all circuits are intrinsically safe, but which contains circuits that can influence the safety of the intrinsically safe circuits to which they are connected.

#### Asymmetrical interference

Asymmetrical means that the source of interference and the potentially susceptible equipment are grounded, i.e., they have a capacitive or galvanic connection to the protective conductor. As shown in the figure, the interference moves from the source along both conductors to the potentially susceptible equipment and back via ground. The terms "common-mode interference" or "common mode" are also used.

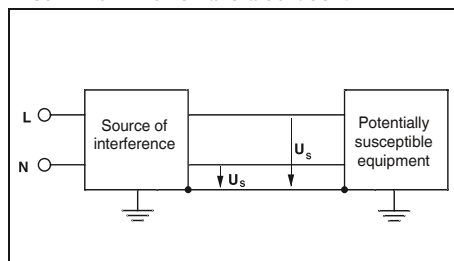

#### Asymmetrical voltage, common mode voltage

Average voltage between each conductor and a specified reference point, usually reference ground or ground.

#### Burst

Pulses which occur repeatedly within a specific time interval.

#### Common mode voltage

The common mode voltage is the voltage which occurs in the event of interference between live conductors and ground.

#### Coupling

Interaction between circuits, in which energy is transferred capacitively, inductively or galvanically from one circuit to the other.

#### Direct or close-up strikes

These cause surge voltages with an energy level that constitutes a considerable part of the total energy of the lightning discharge.

#### Discharge of static electricity; electrostatic discharge; ESD

The transmission of an electrical charge between bodies with different electrostatic potentials when they are in close proximity or touching.

#### Disconnect device

This is a device which disconnects a SPD from the mains when it fails. It is designed to prevent a permanent fault in the system caused by the faulty surge arrester and provide an optical indication of the faulty SPD.

#### Disturbance variable

The disturbance variable is an electromagnetic (or electrical or magnetic) variable, which can have an undesirable influence on electrical equipment.

#### Electromagnetic compatibility (EMC)

The ability of a device or system to operate without faults in an electromagnetic environment without itself causing electromagnetic interference, which would be unacceptable for other devices in this environment.

#### Electromagnetic environment

The sum of all electromagnetic phenomena at a given location.



### Electromagnetic interference

A loss in the quality of the operating behavior, such as malfunction or failure of electrical or electronic equipment, that is caused by an electromagnetic disturbance variable.

### Equipment to be protected

All equipment of a structural system or a range which requires surge protection or lightning protection.

### Equipotential bonding

The removal of potential differences between conductive parts, in which all points assume virtually the same potential.

A distinction is made between functional equipotential bonding and protective equipotential bonding.

### Equipotential bonding conductors

These are electrically conductive connections used to create equipotential bonding.

### Equipotential bonding strip

This is the strip which is designed to connect protective conductors, equipotential bonding conductors, and conductors for functional earth grounding to the ground conductor and the ground electrodes.

### Equipotential bonding system

This refers to all the interconnected equipotential bonding conductors, including the conductive parts such as housing or external conductive parts which work in the same way.

The equipotential bonding system can also be the grounding system or part of a grounding system.

### Exposure

Exposure is an insufficient distance between the lightning protection system and metal installations or electrical systems which leads to a risk of flashover or disruptive discharge in the event of a lightning strike.

### Exposure voltage

The exposure voltage is a voltage that occurs at the exposure point when lightning strikes the lightning protection system.

### Follow current $I_f$

Current which flows through the SPD following discharge and is supplied by the mains. The follow current differs considerably from the continuous operating current.

### Gas-filled surge arrester

The gas-filled surge arrester is a discharge path which is filled with a gas other than air, generally an inert gas.

### Ground

This expression refers to the earth and the ground.

### Ground conductor

A conductor which connects the equipment to be grounded to a ground electrode, as long as the ground conductor is not laid in the ground or, if laid in the ground, is insulated.

### Ground electrode

A conductor embedded in the ground with an electrically conductive connection to ground. Parts of supply lines to a ground electrode, which are not insulated in the ground, are considered to be parts of the ground electrode.

### Grounding

Grounding is the sum of all means and measures used for grounding.

### Grounding resistance

The resistance between the grounding system and the reference ground. The amount of grounding resistance depends on the interaction of the individual ground electrodes.

### Impulse sparkover voltage of 1.2/50 $\mu$ s

Highest voltage value before the disruptive discharge between the electrodes of the spark gap of a SPD.

### Impulse withstand voltage $U_{st}$

The peak value of the highest surge voltage with a predefined form and polarity, which will not lead to a disruptive discharge under the specified test conditions.

Note: the impulse withstand voltage is equal to or greater than the rated surge voltage.

### Inactive parts

Inactive parts are conductive parts that are electrically isolated from all live parts through basic insulation.

### Insertion attenuation

To determine the insertion attenuation of a SPD, the mains and frequency are specified. The attenuation value is defined as the ratio of voltages that occur immediately before and after the insertion point of the SPD to be tested. The result is expressed in decibels.

### Insulation coordination

The assignment of characteristic insulation data for an item of equipment for:

- Expected surge voltages
- Characteristic data of the surge protective device
- Expected ambient conditions
- Protective measures against contamination

### Interference suppression

Measure to reduce or avoid the electromagnetic disturbance variables that occur.

### Intrinsically safe circuit

A circuit protected against sparks and thermal effects that may occur under the conditions specified in DIN EN 60079-11 (which include error-free operation and specific fault conditions), which can cause the ignition of a particular explosive gas atmosphere.

### Intrinsically safe electrical equipment

Electrical equipment in which all circuits are intrinsically safe.

### Lightning protection system

All devices as a whole that provide external and internal lightning protection for the system to be protected.

### Lightning surge current $I_{imp}$

Lightning surge currents are characterized by the parameters peak value, charge, specific energy, and current increase rate. The lightning surge current  $I_{imp}$  is a measurement for the discharge capacity of lightning arresters (class I). It is determined according to a defined test procedure using 10/350  $\mu$ s waveform test pulses.

### Lightning surge voltage

Surge voltage as a result of lightning discharge.

## Explanation of terms

### Lightning test current

The (10/350)  $\mu\text{s}$  lightning test current has a rise time of 10  $\mu\text{s}$  and a decay time to half-value of 350  $\mu\text{s}$ .

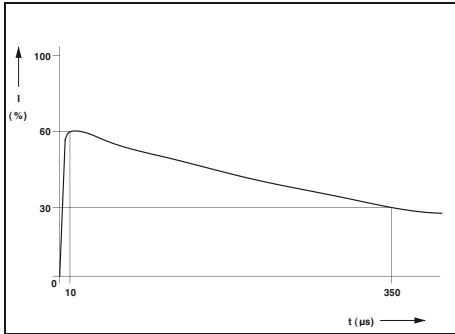

10/350 lightning current pulse according to IEC 62305-1

### Live parts

Live parts are conductors and conductive parts of equipment that are energized under normal operating conditions.

### Maximum continuous voltage $U_c$

The rated voltage is the maximum permissible r.m.s. value of the power-frequency AC voltage, which may be permanently applied to the protective paths of the arrester.

### Nominal current $I_N$ or load current $I_L$

Highest continuous current for products according to IEC 61643 which can flow through the surge protective device at the specified temperature without altering the electrical operating properties. For higher operating temperatures, the nominal current is lower (derating).

### Nominal discharge surge current $I_n$

Peak value of the current flowing through the SPD with surge form (8/20)  $\mu\text{s}$ . It is used to classify the SPD according to class II. Source: EN 61643-11

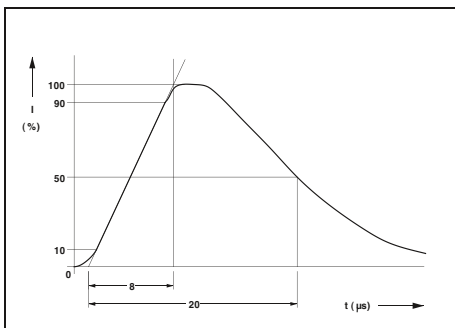

8/20 surge current pulse according to IEC 60060-1

### Nominal voltage $U_N$

A suitable rounded voltage value, which is specified by the manufacturer for equipment for the purpose of designation or identification.

### Normal mode voltage

The normal mode voltage is the voltage which occurs in the event of interference between two conductors of a circuit.

### Potentially susceptible equipment

All electrical equipment whose function can be influenced by disturbance variables is referred to as potentially susceptible equipment. Influence on function may be in the form of a functional disturbance, reduction in function, malfunction or failure.

### Protection level $U_p$

A parameter that characterizes the performance capabilities of the SPD with regard to voltage limitation via its connection terminal blocks. This value, which should be specified by the manufacturer, must be greater than the highest measured value of the clamping voltages.

### Protective paths

The voltage-limiting or switching components of the SPD can be connected between conductor/ conductor, conductor/ground, conductor/neutral conductor, and neutral conductor/ground or a combination of these options. These circuit types are referred to as protective paths.

### Pulse

Rapid, brief alteration of a physical variable, followed by a fast return to the original value.

### Pulse burst; burst

Result of a limited number of pulses or waves of a limited duration.

### Rate of rise

Average rate of change of a variable between two specified values, e.g., 10% and 90% of the peak value.

### Reference ground

An area of the earth, particularly of the earth's surface, which is so far away from the ground conductors that no noticeable voltages occur between any points of this area as a result of the current entering the earth.

### Remote strikes

These usually cause surge voltages with a significantly lower energy level than close-up strikes. Remote strikes are responsible for causing surge voltages in electrical and electronic systems.

### Residual current device (RCD)

Residual current devices are devices which isolate electrical systems from the power supply system as soon as the residual current to ground exceeds a specific value.

### Residual voltage $U_{res}$

The peak voltage value that occurs while discharge surge current is flowing via the terminal blocks of the SPD.

Source: EN 61643-11:2002

### Response

- A response is when either:
- The peak value of the ohmic components of the current flowing through the arrester reaches 5 mA
  - A voltage dip with an increase in the peak value of the current flowing through the arrester to 5 mA occurs

### Selective residual current device

Selective residual current devices are time-delayed circuit breakers.

### Short circuit stability

Highest interference-free short-circuit current the SPD can withstand.

### Source of interference

A source of interference is the origin of disturbance variables. In principle, any electrical equipment, such as motors or fluorescent lamps, can be a source of interference.

### Specialist

A specialist is a person who, because of their education, experience, and instruction, and their knowledge of relevant regulations, can assess any required operations and recognize any possible dangers.

Note: when considering a person's professional training, several years' experience in the relevant field can also be taken into account.

### Spike

A relatively short single-polarity pulse.

### Surface discharge surge arrester

The surface discharge surge arrester, according to DIN VDE 0845 Part 1, is a discharge path in which gas discharge is initiated by means of surface discharge.

### Surge current of (8/20) $\mu\text{s}$

Surge current with a rise time of 8  $\mu\text{s}$  and a decay time to half-value of 20  $\mu\text{s}$ . Source: IEC 60060-1

**Surge current of (10/350)  $\mu$ s**

Surge current with a rise time of 10  $\mu$ s and a decay time to half-value of 350  $\mu$ s. Source: IEC 62305-1

**Surge protection equipment (SPE)**

Surge protection equipment consists of surge protective devices and all equipment in telecommunications systems, including their cables, used for surge protection.

**Surge protective device (SPD)**

A device to limit surge voltages and discharge surge currents. It contains at least one non-linear voltage-limiting component.

**Surge voltage**

Any voltage with a peak value that exceeds the corresponding peak value of the maximum continuous voltage under normal operating conditions. Source: EN 60664-1

**Surge voltage category**

Assignment of electrical equipment to the anticipated surge voltage.

**Surge voltage of (1.2/50)  $\mu$ s**

Surge voltage with a rise time of 1.2  $\mu$ s and a decay time to half-value of 50  $\mu$ s. Source: IEC 60060-1

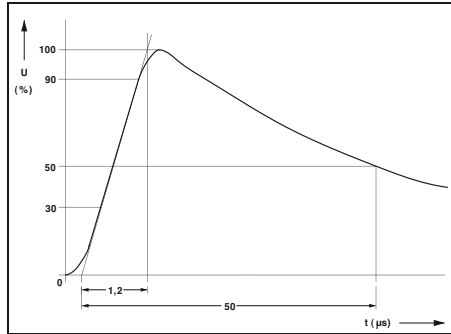

1.2/50 surge voltage pulse according to IEC 60060-1

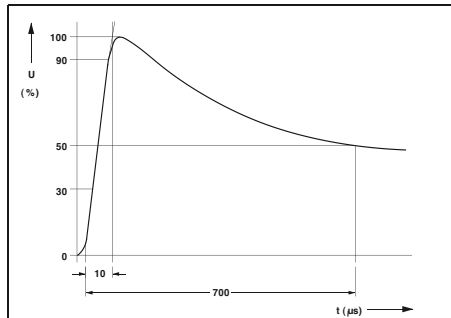

10/700 surge voltage pulse according to ITU-T K.44

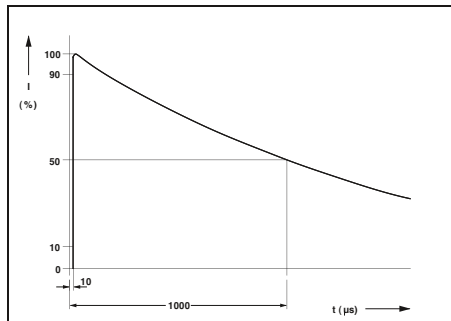

10/1000 surge current pulse according to IEEE C62.41.1

**Switching surge voltage**

Surge voltage as a result of a switching operation.

**Symmetrical interference**

As shown in the figure, the disturbance variable moves from the source along one conductor to the potentially susceptible equipment and back along the other conductor. The terms “normal-mode interference” or “differential mode” are also used.

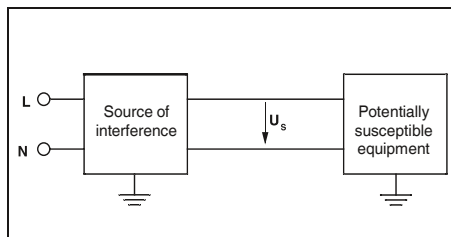

**Symmetrical interference voltage**

Interference voltage between two wires of a cable (e.g., double cable) or between two connection points of electrical equipment for this cable type.

**Symmetrical voltage, differential mode voltage**

Voltage between two live conductors from one defined group.

**Temperature range**

Range between the minimum and maximum temperature that may be present at/in housing. For devices without self-heating, this value is the permissible ambient temperature. For devices with self-heating, these values are the maximum temperatures that may occur at/in the device during operation.

**To ground**

An electrically conductive part, e.g., the lightning protection system is connected to ground via a grounding system.

**Transient**

Describes a phenomenon or variable which changes during what is, in comparison to the time scale being observed, a short period of time between two consecutive stationary states.

**Transients**

Irregular and relatively short positive and/or negative voltage or current changes between two stationary states.

**Varistors**

A varistor is a bipolar non-linear resistor with a symmetrical voltage/current characteristic curve and a resistance value which decreases as the voltage increases.

## Quality in quantity



### Integrated management system

The aim of the Phoenix Contact integrated management system is to coordinate all the requirements regarding products, processes, and organization.

Statutory and regulatory requirements, as well as those of international standards and our customers, are met and, in some cases, even exceeded in all phases of the product lifecycle.

In the Phoenix Contact management system, the integration of quality, environmental protection, and safety in the workplace is monitored each year for conformance by internationally recognized independent bodies. Certification in accordance with international standards ISO 9001, ISO 14001, and BS OHSAS 18001 is the result of our corporate philosophy of meeting the needs of our customers, staff, and environment as best as possible. They serve as the basis for innovative products with the familiar high Phoenix quality standard, actively practiced environmental protection, and responsibility in the field of occupational health and safety. Of course, we integrate all further requirements of standards, international approvals or special customer requirements into company processes.

This system provides a building block for the success of the Phoenix Contact Group and its products and services.

### CE marking

The CE mark was introduced as an important instrument for the free movement of goods and services within the single European market. By attaching the mark to a product, the manufacturer confirms that it complies with all applicable European Union (EU) directives. EC directives describe the product properties with regard to device safety and avoiding danger. These are legally binding regulations of the European Union (EU). In other words, compliance with the requirements is a **statutory condition for**

### marketing the product within the EU.

Where applicable, the products that our company currently manufactures fall within the scope of the following directives:

- 2006/95/EC  
Electrical equipment designed for use within certain voltage limits (Low Voltage Directive)
- 2004/108/EC  
Electromagnetic compatibility (EMC Directive)
- 2006/42/EC  
Safety of machinery (Machinery Directive)
- 94/9/EC  
Equipment and protective systems intended for use in potentially explosive areas (ATEX Directive 100a)
- 1999/5/EC  
Radio and telecommunications terminal equipment (R&TTE)

The standards upon which the specified directives are based, have been part of our standard of development for a long time. This guarantees conformance with European directives. The numbers of the directives indicate their version at the time of publication. In the event of changes to directives and/or standards, our products will undergo conformity assessment again in good time and a new declaration of conformity will be issued promptly. The current declarations for each product can also be found in our Download Center.

The EMC Directive occupies a special place among the European directives listed. It defines electromagnetic compatibility as a fundamental property of devices based on mandatory guidelines. European Law therefore acknowledges the electromagnetic compatibility of devices and systems as an important condition for error-free operation of machinery and systems. Phoenix Contact is one of the leading international companies in surge protection, and therefore possesses broad expertise in EMC. This expertise and the experience gained over years of developing and applying industrial interface and communication technology have resulted in our products having an extremely high standard of quality with regard to electromagnetic compatibility. It was with a view to providing other companies with this expertise that our associate company, Phoenix Testlab, was founded. Phoenix Testlab GmbH is an independent, accredited service provider offering EMC testing that conforms to European standards. At Phoenix Testlab, devices are also tested with regard to their electrical safety, mechanical influences, and their behavior in relation to environmental influences. Furthermore,

Phoenix Testlab is a “Notified Body” in accordance with EMC Directive 2004/108/EC and according to R&TTE Directive 1999/5/EC for radio and telecommunications terminal equipment. As a “Telecom Certification Body” (TCB), Phoenix Testlab may also approve these products for markets in the USA, Canada, and Japan.

### Standards and regulations

All relevant standards and regulations are used as the basis for the development and maintenance of our products.

International standards are subject to continuous changes as a result of harmonization and new developments. In line with this process, the current version of all standards that are relevant to our products is documented in the product area on our website at [www.phoenixcontact.net/products](http://www.phoenixcontact.net/products).

### Online product information service on the web

Phoenix Contact's product range is growing constantly.

Due to our commitment to product monitoring, all products are subject to improvement.

The Internet is an ideal platform to quickly communicate new product developments and improvements to the market.

You can quickly access the relevant Phoenix Contact website for your region via [www.phoenixcontact.com](http://www.phoenixcontact.com). Here, you will always find the latest overview of products, solutions, and services from Phoenix Contact. This includes technical documents, such as data sheets and user manuals, the latest driver and demo software, plus a means of contacting the appropriate contact person directly.

## Shock protection

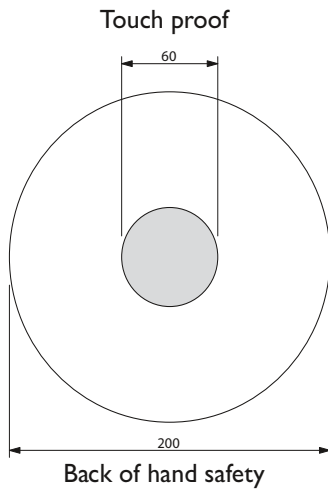

### Example: pressure actuation

The accident prevention regulations BGV A 2 issued by the German employer's liability insurance association for precision mechanics and electrical engineering apply to the operators of electrical systems and are aimed at the prevention of electrical accidents by means of special safety requirements.

These regulations contain specifications regarding the safety distances for work, operation, and occasional handling in the proximity of "live parts" in low-voltage systems up to 1000 V ~ or 1500 V –.

- Work with live parts is only permitted once they have been de-energized. Operational activities are only permitted in the vicinity of live parts if these parts are de-energized or are protected against direct contact (§ 6). The following safety measures are applicable when working in close proximity to live parts:
- Provision of the de-energized state for the duration of the work
- Ensure shock protection is in place in the form of covers or barriers during the work
- Assurance that proximity limits will not be violated (§ 7)

The term "occasional handling" has been introduced for the operation of elements such as pushbuttons, rocker arms or rotary buttons in the proximity of live parts.

In VDE 0105-1, this is covered by "operation with partial protection against direct contact".

Detailed specifications for "occasional handling" can be found in DIN VDE 0106-100. This specifies to what degree live parts in the proximity of operating elements are to be protected against contact. The basis for this is the definition of a "protection area for occasional handling"; this is the area into which the user must reach in order to handle the machine.

The most important thing is that an area

formed by an even envelope curve 30 mm in radius must surround the live parts. This area must be **touch proof**, i.e., the live parts of the electrical device must not be within reach of the VDE test finger in accordance with IEC 60529/DIN VDE 0470-1 (test finger).

Back of hand safety is specified for the "rest of the area" up to 100 mm around the operating element. **Back of hand safety** means that when a force of 50 N is applied to a ball with a diameter of 50 mm, this does not come into contact with the live parts of the equipment. No special measures for shock

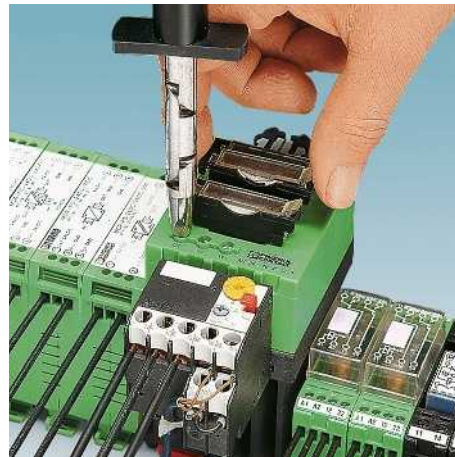

protection are provided outside this area.

Note: systems and equipment that are operated with SELV up to 25 V ~ or 60 V – are considered to be protected against direct contact.

According to § 5, Subsection 4 of the BGV A 2 regulations, there is no need to test the condition of the system prior to initial startup if the company has confirmation from the manufacturer or installer that the electrical systems and equipment conform to



BGV A 2. The confirmation required relates to systems and equipment that have been installed and are ready for operation and can only be issued by the installer or installation

company. The manufacturer of the electrical equipment can only issue a confirmation that products have been produced in accordance with the relevant electrotechnical DIN VDE regulations stipulated in BGV A 2. The installer must bear this in mind when selecting the equipment to be used.

In the field of connection technology, Phoenix Contact offers a wide range of products that are touch proof or that can be protected against contact using covers. Depending on the conditions, all of this must be taken into account when selecting the individual types of terminal block and accessories.

## Quality features of insulating housing

### Thermoplastics

The majority of our insulating housing is made from thermoplastic materials. Roughly speaking, these can be divided into amorphous and semi-crystalline substances. Thermoplastics are processed using the efficient and environmentally-friendly injection molding process. They have good recycling properties and can be re-used. We use many materials that are modified in different ways to meet the demanding requirements that electrical and electronic modules, devices, and systems have to meet with regard to their mechanical, thermal, and electrical properties.

### Behavior of plastics under the influence of temperature (operating temperatures, mechanical influences)

All plastics undergo a process referred to as thermal aging when they are subjected to heat over long periods. This process causes changes in the mechanical and electrical properties of the material. External influences, e.g., radiation, additional mechanical, chemical or electrical stresses, amplify this effect. Special tests on samples can yield characteristic data which provides a good means of drawing comparisons between different plastics. However, applying these characteristics to an evaluation of molded plastic parts is only possible to a limited extent, and can only give the designer a rough guide when it comes to selecting a plastic material. This catalog uses the following assessment criteria: the **RTI value** according to UL746B/ANSI 746 B (elec. based on dielectric strength) and the **Ti value** according to IEC 60216-1 (based on a 50% reduction in tensile strength after 20,000 hours).

IEC 60947-7-1/EN 60947-7-1 specifies a permissible temperature increase of 45 K for modular terminal blocks under nominal load. Phoenix Contact terminal blocks meet this requirement.

The properties of plastics are not only affected by the influence of heat as described above; they also undergo changes as a result of cold influences. When subjected to cold as well as low levels of humidity, plastics become increasingly brittle with the result that they are no longer capable of withstanding the same mechanical loads. As the table on the right shows, the plastics concerned can be used down to a temperature of  $-40^{\circ}\text{C}$ , but only without a mechanical load. As far as the products presented in the catalog are concerned, it is the ambient temperature specified in each case that is to be regarded as definitive for operation. Regardless of the plastics used, this may be subject to further restrictions (e.g., limited to  $-20^{\circ}\text{C}$ ) as a result

of the components used or other restrictive parameters.

At very low temperatures, this means that any form of mechanical load on the plastic components must be avoided (e.g., mounting of products on/removal of products from the DIN rail, actuation of terminal points, locking/ejection of relays from bases, prizing out of plug-in bridges, bending of cables and lines, etc.), as there is always an associated risk of damage. Unless otherwise indicated, it is recommended that you carry out the specified mounting/operational tasks in a temperature range from  $-10^{\circ}\text{C}$  to  $+40^{\circ}\text{C}$ .

### Inflammability characteristics of plastics (UL 94)

Inflammability tests for plastics have been defined by Underwriters Laboratories (USA) in regulation UL 94. This applies to all areas of application, but in particular to electrical engineering. A horizontal or vertical test is carried out at the test laboratory to determine the inflammability of the plastic material with a naked flame. In order of increasing resistance to combustion, the evaluation classes are HB, V2, V1, V0, and 5V. Test results are recorded on "yellow cards" and are published annually in the **Recognized Component Directory**.

### Thermoplastics: non-reinforced polyamide, PA

We use modern, semi-crystalline polyamide insulation material, which has now become an essential component in electrical engineering and electronics. It has long occupied a leading position and is authorized for use by the relevant approval authorities such as the CSA, NEMKO, KEMA, PTB, SEV, UL, VDE, etc.

Polyamide also has excellent electrical, mechanical, chemical, and other properties, even at high operating temperatures. Brief peak temperatures up to approximately  $200^{\circ}\text{C}$  are permitted as a result of heat aging stabilization. Depending on the type (PA 4.6, 6.6, 6.10, etc.), its melting point is in the region of  $215^{\circ}\text{C}$  to  $295^{\circ}\text{C}$ .

Polyamide absorbs moisture from its surroundings, on average 2.8%. However, this moisture is not in the form of crystallization water in the plastic itself, but chemically bonded  $\text{H}_2\text{O}$  groups in the molecule structure. This makes the plastic flexible and resistant to breakage, even at temperatures as low as  $-40^{\circ}\text{C}$ . According to UL 94, PA belongs to inflammability class V2 to V0.

### Thermoplastics: polyester, PBT

We use the semi-crystalline thermoplastic polyester in non-reinforced and fiberglass-reinforced variants for special applications which require increased dimensional and form stability.

In addition to the high operating temperature, the material is characterized by excellent mechanical strength and hardness, and does not absorb moisture from its surroundings. PBT is therefore particularly suitable for strips, for example, which are soldered onto PCBs and subsequently have to pass a burn-in test while they are subjected to heat. According to UL 94, PBT belongs to inflammability class V2 to V0.

### Thermoplastics: polycarbonate, PC

Polycarbonate combines many advantages such as rigidity, impact strength, transparency, dimensional stability, good insulation properties, and resistance to heat.

This amorphous material only absorbs moisture to a very limited degree, and is used for items such as large, rigid electronic component housing.

In its transparent form, polycarbonate is particularly suitable for use as cover profiles or marking materials.

PC has good resistance properties against mineral acids, saturated aliphatic hydrocarbons, gasoline, greases, and oils.

The material is less resistant to solvents, benzene, lyes, acetone, and ammonia. Strain cracks may result from contact with certain chemicals.

According to UL 94, PC belongs to inflammability class V2 to V0.

**Thermoplastics:**

**polycarbonate fiber-reinforced, PC-F**

Compared to non-reinforced materials, fiber-reinforced polycarbonates feature greater rigidity, impact strength, and operating temperature. In other respects, their properties are largely identical to those of non-reinforced polycarbonate.

**Thermoplastics: ABS**

We use the thermoplastic molding compound ABS for products which must have good impact and notched impact properties in addition to high mechanical stability and rigidity. The products are resistant to chemicals and stress cracking due to their special surface quality and hardness.

The characteristic thermal properties provide good dimensional stability at both low and high temperatures. Products made from ABS can be coated with metallic surfaces, e.g., nickel.

According to UL 94, the molding compound used belongs to inflammability class HB to V0.

**Dimensions: width / height / depth**

The dimensions for “width / height / depth” are defined as follows for all DIN-rail mountable products in the INTERFACE range:

- Width: measurement taken along the DIN rail
- Height: measurement taken across the DIN rail
- Depth: measurement taken starting from the mounting plate and including the NS 35/7,5 DIN rail (EN 60715)

The width, height, and depth never change, even if the products shown in this catalog happen to be photographed from two different perspectives (horizontal or vertical).

To make things easier for you, one of the following two symbols has been included next to each product photo:



Properties	Unit/level	Polyamide PA	Polyester PBT	Polycarbonate PC	Polycarbonate PC-F	ABS
Operating temperature	RTI */**	°C ≤ 105	≤ 105	≤ 125	≤ 120	≤ 80
Minimum temperature (without mechanical load)		°C -40	-40	-40	-40	-40
Dielectric strength acc. to IEC 60243-1/DIN VDE 0303-21	kV/cm	600	400	> 300		850
Creep resistance	CTI...M	550	225	175		200
IEC 60112/DIN VDE 0303-1	CTI...	600	225	175	175	600
Tropical and termite resistance		Good	Good	Good		
Specific contact resistance IEC 60093/VDE 0303 Part 30; IEC 60167/VDE 0303 Part 31	Ω cm	10 <sup>12</sup>	10 <sup>16</sup>	> 10 <sup>16</sup>	> 10 <sup>14</sup>	10 <sup>14</sup>
Surface resistance IEC 60093/VDE 0303 Part 30; IEC 60167/VDE 0303 Part 31	Ω	10 <sup>10</sup>	10 <sup>13</sup>	> 10 <sup>14</sup>		10 <sup>13</sup>
Inflammability class according to UL 94		V2 - V0	V0	V2 - V0	V0	HB - V0

\* According to UL 746 B/ANSI 746 B (elec.)      \*\* Minimum value

**Tightening torque of terminal block screws**

IEC 60947-1/EN 60947-1, modified, Table 4 specifies tightening torques for screw connections based on the screw size for electrical and mechanical type tests.

Extract from IEC 60 947-1/EN 60 947-1, Table 4  
The torque according to IEC and the recommended tightening torque for Phoenix Contact terminal blocks are specified.

Thread	Head screw with slot	
	Torque [Nm]	Recommended tightening torque [Nm]
M2.5 (M2.6)	0.4	0.4 - 0.5
M3	0.5	0.5 - 0.6
M3.5	0.8	0.8 - 1.0
M4	1.2	1.2 - 1.5
M5	2.0	3
M6	2.5	4

## Connection cross section

The rated cross sections of modular terminal blocks must be specified by the manufacturer in accordance with IEC 60947-7-1. The rated cross section is the maximum conductor cross section that can be connected in single-, multi- or fine-strand versions subject to specific thermal, mechanical and electrical requirements.

The manufacturer must also specify the **rated connection capacity**, i.e., the area of the conductor that can be connected, as well as the number of conductors that can be connected simultaneously and the necessary preparation of the conductor ends. The conductors can be **solid (single or multi-strand)** or **stranded (fine-strand)**.

These values can be found in the product-specific technical data.

The rated connection capacity of the Phoenix Contact modular terminal blocks usually exceeds standard requirements, which specify that it must only be possible to connect one conductor with one of the two next smallest cross sections, excluding the rated cross section (standardized for the cross section range from 0.2 to 35 mm<sup>2</sup>).

In addition, conductors with a rated cross section can usually be wired with ferrules with plastic sleeve.

Phoenix Contact modular terminal blocks are designed to allow copper conductors to be connected to them untreated. "Special treatment" or the use of ferrules – both permitted according to IEC 60947-7-1 – is not

required. If ferrules are nevertheless used to protect stranded conductors against splicing, the connection capacity of the stranded conductor is generally reduced by one level.

Structure and dimensions of connecting cables													
Cross section [mm <sup>2</sup> ]	Single-strand		Multi-strand		Fine-strand		American Wire Gauge [AWG]						
	Diameter max. dimension	Number of wires	Diameter max. dimension	Number of wires (minimum number)	Diameter max. dimension	Number of wires (guide value)	Gauge No. AWG	Solid wires		Stranded wires			
								[Ø mm]	[circ. mils]	[mm <sup>2</sup> ]	[Ø mm]	[circ. mils]	[mm <sup>2</sup> ]
0.2	0.5	1	–	–	–	–	24	0.51	404	0.21	–	–	–
0.5	0.9	1	1.1	7	1.1	16	20	0.81	1022	0.52	0.97	1111	0.56
0.75	1.0	1	1.2	7	1.3	24	18	1.02	1620	0.82	1.16	1600	0.82
1	1.2	1	1.4	7	1.5	32	(17)	1.15	2050	1.04			
–	–	–	–	–	–	–	16	1.29	2580	1.31	1.50	2580	1.32
1.5	1.5	1	1.7	7	1.8	30	(15)	1.45	3260	1.65			
–	–	–	–	–	–	–	14	1.63	4110	2.08	<b>1.85</b>	4100	2.09
2.5	1.9	1	2.2	7	2.3	50	(13)	1.83	5180	2.63			
–	–	–	–	–	–	–	12	2.05	6530	3.31	<b>2.41</b>	6500	3.32
4	2.4	1	2.7	7	2.9	56	(11)	2.30	8230	4.17			
–	–	–	–	–	–	–	10	2.59	10380	5.26	2.95	10530	5.37
6	2.9	1	3.3	7	3.9	84	(9)	2.91	13100	6.63			
–	–	–	–	–	–	–	8	3.26	16510	8.37	3.73	16625	8.48
10	3.7	1	4.2	7	5.1	80	(7)	3.67	20800	10.56	4.15	20820	10.55
–	–	–	–	–	–	–	6	4.12	26240	13.30	4.67	26250	13.39
16	4.6	1	5.3	7	6.3	126	(5)	4.62	33100	16.77	5.24	33100	16.77
–	–	–	–	–	–	–	4	5.19	41740	21.15	5.90	41650	21.24
25	–	–	6.6	7	7.8	196	3	5.83	52600	26.67	6.61	52630	26.67
35	–	–	7.9	7	9.2	276	2	6.54	66360	33.62	7.42	66150	33.74
–	–	–	–	–	–	–	1	7.35	83690	42.41	8.33	83706	42.69

## Current carrying capacity







































Standard IEC 60947-7-1/EN 60947-7-1/ DIN VDE 0611-1 specifies the test currents for the individual conductor cross sections listed in the adjacent table. The corresponding currents are listed with the connection data for the individual terminal blocks. The type tests for modular terminal blocks are based on this data.

### Test currents according to IEC 60947-7-1/EN 60947-7-1, Table 5

Rated cross section	[mm <sup>2</sup> ]	0.2	0.5	0.75	1.0	1.5	2.5	4	6	10	16
Test current	[A]	4	6	9	13.5	17.5	24	32	41	57	76



**Overview of certification bodies and safety marks**

Certification bodies and approvals		Country code	Explosion protection		Country code	Ship classification societies		Country code
	IECEE CB Scheme (in combination with certifying body)	International		FM Approvals	US		Bureau Veritas	FR
CCA	CENELEC Certification Agreement (CCA inspection report) (in combination with certifying body)	EU		DEKRA Certification B.V.	NL		Germanischer Lloyd AG	DE
	Canadian Standards Association (CSA)	CA		Physikalisch-Technische Bundesanstalt	DE		Lloyd's Register EMEA	GB
 	Underwriters Laboratories Inc. (UL)	US		QS Schaffhausen	CH		Nippon Kaiji Kyokai	JP
 	Underwriters Laboratories Inc. (UL) - UL approval for Canada -	CA		VTT Expert Services Oy	FI		Det Norske Veritas	NO
 	Underwriters Laboratories Inc. (UL) Combined logo - UL approval for the USA and Canada -	US CA		IBExU Institut für Sicherheitstechnik GmbH	DE		Polski Rejestr Statków	PL
	INSIEME PER LA QUALITA'E LA SICUREZZA	IT		TÜV Rheinland do Brasil	BR		Russian Maritime Register of Shipping	RU
	Gosudarstvennoe Komitet Standartov (GOST)	RU	 	Underwriters Laboratories Inc. (UL)	US		Korean Register of Shipping	KR
	DEKRA Certification B.V.	NL		TÜV Nord	DE		American Bureau of Shipping	US
	Österreichischer Verband für Elektrotechnik	AT		DEKRA EXAM GmbH	DE			
	South African Bureau of Standards	ZA						
	electrosuisse SEV Verband für Elektro-, Energie- und Informationstechnik	CH						
 	Verband Deutscher Elektrotechniker e.V. (VDE) - Approval of drawings - Reports with production monitoring	DE						
 	Berufsgenossenschaft (BG) GS - Geprüfte Sicherheit	DE						
	TÜV Rheinland Industrie Service GmbH	DE						

**EMC: Class A product:**

In accordance with statutory regulations, our products are indicated with this footnote if they are intended for use in industrial environments. This means that the permissible limit values for residential applications may be exceeded in the event of conducted and emitted interference. In such cases, the operator may have to take additional safety measures in order to ensure electromagnetic compatibility in residential applications.

**Note:**

Subject to changes that serve the purpose of technical progress.

Dimensioning of clearances

Schematic for determining clearances

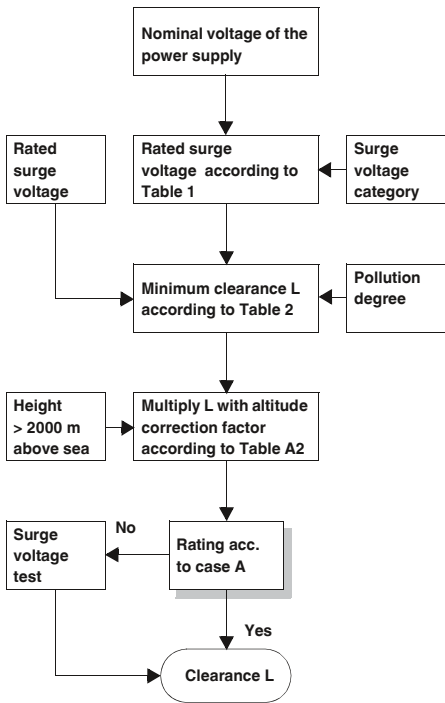

**Altitude correction factors (extract from Table A.2)**

Height in m	Normal air pressure in kPa	Multiplication factor for gaps
2000	80.0	1.00
3000	70.0	1.14
4000	62.0	1.29
5000	54.0	1.48
6000	47.0	1.70
7000	41.0	1.95
8000	35.5	2.25
9000	30.5	2.62
10000	26.5	3.02
15000	12.0	6.67
20000	5.5	14.50

Rated surge voltages for items that are directly supplied by the low-voltage network (extract from Table 1)

Nominal voltage of the power supply system <sup>1)</sup> (mains) acc. to IEC 60038 <sup>3)</sup> [V]		Conductor-neutral conductor voltage derived from the total nominal AC voltage or nominal DC voltage [V]	Rated surge voltage <sup>2)</sup> [V] Surge voltage category <sup>4)</sup>			
Three-phase	Single-phase		I	II	III	IV
	120 to 240	50	330	500	800	1500
		100	500	800	1500	2500
		150	800	1500	2500	4000
230/400 277/480		300	1500	2500	4000	6000
400/690		600	2500	4000	6000	8000
1000		1000	4000	6000	8000	12000

- <sup>1)</sup> Refer to Appendix B for application in existing deviating low-voltage networks and their nominal voltages.
- <sup>2)</sup> Items with this rated surge voltage may be used in systems in accordance with IEC 60364-4-443.
- <sup>3)</sup> The slash, i.e., /, indicates a three-phase 4-conductor system. The lower value is the conductor-to-neutral conductor voltage, whereas the higher value is the conductor-to-conductor voltage. When only one value is specified, it refers to a three-phase 3-conductor system, and indicates the conductor-to-conductor voltage.
- <sup>4)</sup> Refer to 2.2.2.1.1 for an explanation of surge voltage categories.

Minimum clearances for surge voltages (extract from Table 2)

Required impulse withstand voltage <sup>1) 5)</sup>	Condition A Non-homogeneous field (refer to 1.3.15)			Condition B Homogeneous field (refer to 1.3.14)		
	Pollution degree <sup>6)</sup>			Pollution degree <sup>6)</sup>		
	1 [mm]	2 [mm]	3 [mm]	1 [mm]	2 [mm]	3 [mm]
0.33 <sup>2)</sup>	0.01			0.01		
0.40	0.02			0.02		
0.5 <sup>2)</sup>	0.04	0.2 <sup>3) 4)</sup>		0.04	0.2 <sup>3) 4)</sup>	
0.60	0.06			0.06		
0.80 <sup>2)</sup>	0.10		0.8 <sup>4)</sup>	0.10		0.8 <sup>4)</sup>
1.0	0.15			0.15		
1.2	0.25	0.25		0.2		
1.5 <sup>2)</sup>	0.5	0.5		0.3	0.3	
2.0	1.0	1.0	1.0	0.45	0.45	
2.5 <sup>2)</sup>	1.5	1.5	1.5	0.6	0.6	
3.0	2.0	2.0	2.0	0.8	0.8	
4.0 <sup>2)</sup>	3	3	3	1.2	1.2	1.2
5.0	4	4	4	1.5	1.5	1.5
6.0 <sup>2)</sup>	5.5	5.5	5.5	2	2	2
8.0 <sup>2)</sup>	8	8	8	3	3	3
10	11	11	11	3.5	3.5	3.5
12 <sup>2)</sup>	14	14	14	4.5	4.5	4.5
15	18	18	18	5.5	5.5	5.5
20	25	25	25	8	8	8
25	33	33	33	10	10	10
30	40	40	40	12.5	12.5	12.5
40	60	60	60	17	17	17
50	75	75	75	22	22	22
60	90	90	90	27	27	27
80	130	130	130	35	35	35
100	170	170	170	45	45	45

- <sup>1)</sup> This voltage is:
  - For function insulation: the highest surge voltage expected for the clearance
  - For basic insulation, if influenced directly or considerably by surge voltages from the low-voltage network: the item's rated surge voltage
  - For a different basic insulation: the highest surge voltage possible in the circuit
- <sup>2)</sup> Preferred values
- <sup>3)</sup> For PCBs, the values of pollution degree 1 are applicable, except that no deviation below the value of 0.04 mm is permitted, as specified in Table 4.
- <sup>4)</sup> Minimum clearances for pollution degrees 2 and 3 are based on the corresponding creepage distances. This resistance is reduced due to the effects of humidity.
- <sup>5)</sup> Values can be interpolated for parts or circuits within items that are subjected to surge voltages.
- <sup>6)</sup> The distances for pollution degree 4 are equal to those for pollution degree 3, except that the minimum clearance is 1.6 mm.

Dimensioning of creepage distances

Schematic for determining creepage distances

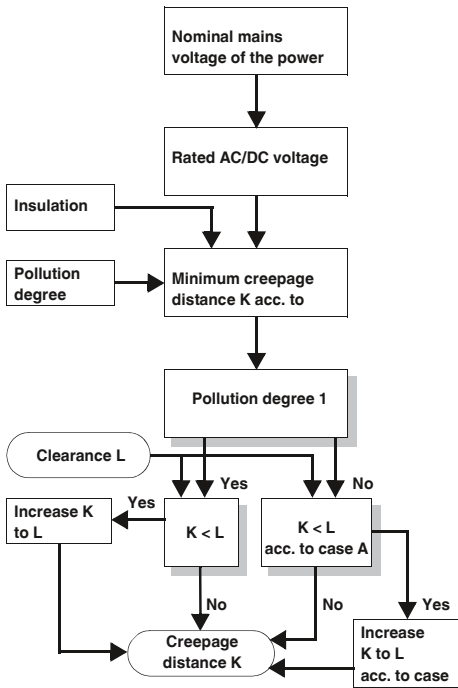

Single-phase 3 or 2-conductor AC or DC voltage systems (extract from Table 3a)

Nominal voltage of the power supply system (mains) *)	Voltages for Table 4	
	for conductor-conductor	for conductor-ground insulation 1)
	All systems	3-conductor systems center point
[V]	[V]	[V]
12.5	12.5	-
24	25	-
25	-	-
30	32	-
42	-	-
48	50	-
50 **)	-	-
60	63	-
30 - 60	63	32
100 **)	100	-
110	125	-
120	-	-
150 **)	160	-
220	250	-
110 - 220	250	125
220 - 240	-	-
300 **)	320	-
220 - 440	500	250
600 **)	630	-
480 - 960	1000	500
1000 **)	1000	-

1) Conductor-ground insulation levels for non-grounded systems or those grounded through impedance correspond to conductor-conductor insulation levels as the operating voltage of every conductor to ground can, in practice, reach the conductor-conductor voltage. This is due to the fact that the actual voltage to ground is determined by the insulation resistance and the capacitive reactance of each conductor to ground. A low (but permissible) insulation resistance of one conductor can thereby practically ground it and increase the other two to conductor-conductor voltage to ground.  
 \*) Refer to 2.2.1 for correlation with the rated voltage.  
 \*\*) These values correspond to the values in Table 1.

Three-phase 4 or 3-conductor AC voltage systems (extract from Table 3b)

Nominal voltage of the power supply system (mains) *)	Voltages for Table 4		
	for conductor-conductor insulation	Insulation for conductor-conductor insulation	
	All systems	Three-phase 4-conductor systems with grounded neutral conductor 2)	Three-phase 3-conductor systems non-grounded 1) or conductor grounded
[V]	[V]	[V]	[V]
60	63	32	63
110/120/127	125	80	125
150 **)	160	-	160
208	200	125	200
220/230/240	250	160	250
300 **)	320	-	320
380/400/415	400	250	400
440	500	250	400
480/500	500	320	500
575	630	400	630
600 **)	630	-	630
660/690	630	400	630
720/830	800	500	800
960	1000	630	1000
1000 **)	1000	-	1000

1) Conductor-ground insulation levels for non-grounded systems or those grounded through impedance correspond to conductor-conductor insulation levels as the operating voltage of every conductor to ground can, in practice, reach the conductor-conductor voltage. This is due to the fact that the actual voltage to ground is determined by the insulation resistance and the capacitive reactance of each conductor to ground. A low (but permissible) insulation resistance of one conductor can thereby practically ground it and increase the other two to conductor-conductor voltage to ground.  
 2) For items designed for use in three-phase 4-conductor and three-phase 3-conductor systems, grounded as well as non-grounded, only the values for 3-conductor systems may be used.  
 \*) Refer to 2.2.1 for correlation with the rated voltage.  
 \*\*) These values correspond to the values in Table 1.

Creepage distances to prevent failures occurring due to creepage (extract from Table 4)

Voltage 1) r.m.s. value	Minimum creepage distances									
	Printed circuits		Pollution degree							
	Pollution degree									
	1	2	1	2			3			
	All insulation material groups	All insulation material groups except IIIb	All insulation material groups	Insulation material group			Insulation material group			
[V]	[mm]	[mm]	[mm]	I [mm]	II [mm]	III [mm]	I [mm]	II [mm]	III 2) [mm]	
10	0.025	0.04	0.08	0.40	0.40	0.40	1.00	1.00	1.00	
12.5	0.025	0.04	0.09	0.42	0.42	0.42	1.05	1.05	1.05	
16	0.025	0.04	0.10	0.45	0.45	0.45	1.10	1.10	1.10	
20	0.025	0.04	0.11	0.48	0.48	0.48	1.20	1.20	1.20	
25	0.025	0.04	0.125	0.50	0.50	0.50	1.25	1.25	1.25	
32	0.025	0.04	0.14	0.53	0.53	0.53	1.30	1.30	1.30	
40	0.025	0.04	0.16	0.56	0.80	1.10	1.4	1.6	1.8	
50	0.025	0.04	0.18	0.60	0.85	1.20	1.5	1.7	1.9	
63	0.040	0.63	0.20	0.63	0.90	1.25	1.6	1.8	2.0	
80	0.063	0.10	0.22	0.67	0.95	1.3	1.7	1.9	2.1	
100	0.10	0.16	0.25	0.71	1.00	1.4	1.8	2.0	2.2	
125	0.16	0.25	0.28	0.75	1.05	1.5	1.9	2.1	2.4	
160	0.25	0.40	0.32	0.80	1.1	1.6	2.0	2.2	2.5	
200	0.40	0.63	0.42	1.00	1.4	2.0	2.5	2.8	3.2	
250	0.56	1.00	0.56	1.25	1.8	2.5	3.2	3.6	4.0	
320	0.75	1.60	0.75	1.60	2.2	3.2	4.0	4.5	5.0	
400	1.00	2.00	1.00	2.00	2.8	4.0	5.0	5.6	6.3	
500	1.30	2.50	1.30	2.50	3.6	5.0	6.3	7.1	8.0	
630	1.80	3.20	1.8	3.2	4.5	6.3	8.0	9	10.0	
800	2.40	4.00	2.4	4.0	5.6	8.0	10.0	11	12.5	
1000	3.20	5.00	3.2	5.0	7.1	10	12.5	14	16.0	
1250			4.2	6.3	9	12.5	16	18	20	
1600			5.6	8	11	16	20	22	25	
2000			7.5	10	14	20	25	28	32	
2500			10	12.5	18	25	32	36	40	
3200			12.5	16	22	32	40	45	50	
4000			16	20	28	40	50	56	63	
5000			20	25	36	50	63	71	80	
6300			25	32	45	63	80	90	100	
8000			32	40	56	80	100	110	125	
10000			40	50	71	100	125	140	160	

1) This voltage is:  
 a) For function insulation: the working voltage  
 b) For basic and additional insulation of a circuit supplied directly by the low-voltage network: either the voltage selected from Table 3a or 3b on the basis of the rated voltage of the equipment or the rated insulation voltage  
 c) For basic and additional insulation of systems, equipment and internal circuits which are not supplied directly from the mains: the highest r.m.s. value of the voltage that, within the bounds of the rated data, can occur in the system, the equipment or the internal circuit, when supplied with rated voltage and in the case of the most unfavorable combination of operating conditions.  
 2) With pollution degree 3, insulation material group IIIb is not recommended for use if voltages are greater than 630 V.

# Index

## Alphabetical

Type	Order No.	Page	Type	Order No.	Page	Type	Order No.	Page	Type	Order No.	Page
<b>A</b>	ADAPTER KOAX TYP F	2880972 142	CB TM1 3A F1 P	2800860	261	CT 10-2/2-GS/3E	2765408	108	EC-E4 4A	0903035	268
			CB TM1 3A M1 P	2800849	260	CT 10-2/2-GS/3E-110AC	2920829	108	EC-E4 6A	0903036	268
			CB TM1 3A SFB P	2800838	259	CT 10-2PE/FS-24	2807955	106	EC-E4 8A	0903037	268
			CB TM1 4A F1 P	2800861	261	CT 10-2PE/FSR-24	2807968	107	ECP 4	0912034	273
<b>B</b>	BATTERY MOUNTING KIT BNC-DV 50 BNC-DV 75 BNC-V 50	2320788 229 2805038 141 2805083 141 2805041 141	CB TM1 4A M1 P	2800850	260	CTM 1X2- 24DC	2838513	102	ECP-E 2A	0900210	270
			CB TM1 4A SFB P	2800839	259	CTM 1X2- 60DC	2838568	102	ECP-E 3A	0900317	270
			CB TM1 5A F1 P	2800862	261	CTM 1X2-110AC	2838539	102	ECP-E 4A	0900414	270
			CB TM1 5A M1 P	2800851	260	CTM 2X1- 12DC	2838584	102	ECP-E 6A	0900618	270
<b>C</b>	C-SAT-BOX C-TV-SAT C-TV/HIFI C-UB/E	2880561 142 2856993 142 2857002 142 2763701 137	CB TM1 5A SFB P	2800840	259	CTM 2X1- 24DC	2838500	102	ECP-E 8A	0900812	270
			CB TM1 6A F1 P	2800863	261	CTM 2X1- 5DC	2838571	102	ECP-E 10A	0901002	270
			CB TM1 6A M1 P	2800852	260	CTM 2X1- 60DC	2838542	102	ECP-E-12A	0900126	270
			CB TM1 6A SFB P	2800841	259	CTM 2X1-110AC	2838526	103	ECP-E2-10A	0900100	271
<b>D</b>	C-UB-5DC C-UB-5DC/E C-UB-5DC/E 75 C-UB-24DC	2797858 140 2782300 140 2763604 140 2797861 140	CB TM2 0.5A M1 P	2800879	261	CTM 2X1-180DC-GS	2838636	103	ECP-E2-12A	0900207	271
			CB TM2 0.5A SFB P	2800868	259	CTM 2X1-180DC-GS-P	2838623	103	ECP-E2-1A	0900139	271
			CB TM2 10A F1 P	2800898	261	CTM EST	2838649	104	ECP-E2-2A	0900236	271
			CB TM2 10A M1 P	2800887	261	CTM ISDN	2838555	104	ECP-E2-3A	0900333	271
<b>E</b>	C-UB-24DC/E C7/16-LAMBDA/4-2.25-BB C7/16-LAMBDA/4-2.25-SB CB 1/10-1/10 UT-BE	2782313 140 2801060 139 2801059 139 2801305 258	CB TM2 10A SFB P	2800876	259	D-DEK 1,5 BK	2838995	94	ECP-E3 12A	0912052	272
			CB TM2 12A F1 P	2800889	261	D-DEK 1,5 BU	2838982	95	ECP-E3 1A	0912041	272
			CB TM2 12A M1 P	2800888	261	D-DS1-A/RJ45-BB	2838050	129	ECP-E3 2A	0912042	272
			CB TM2 12A SFB P	2800877	259	D-LAN-19"-12	2880150	115	ECP-E3 3A	0912043	272
<b>F</b>	CB 1/6-2/4 PT-BE CB E1 24DC/10A S-C P CB E1 24DC/10A S-R P CB E1 24DC/1A NC P	2800929 258 2800928 257 2800914 257 2800915 257	CB TM2 2A SFB P	2800870	259	D-LAN-19"-16	2880147	115	ECP-E3 4A	0912044	272
			CB TM2 3A F1 P	2800893	261	D-LAN-19"-20	2880134	115	ECP-E3 6A	0912046	272
			CB TM2 3A M1 P	2800882	261	D-LAN-19"-24	2838791	115	ECP-E3 8A	0912048	272
			CB TM2 3A SFB P	2800871	259	D-LAN-19"-4	2880176	115	ECP-LOCK	0912021	273
<b>G</b>	CB E1 24DC/1A NO P CB E1 24DC/1A S-C P CB E1 24DC/1A S-R P CB E1 24DC/2A NC P	2800901 256 2800922 257 2800908 257 2800916 257	CB TM2 4A F1 P	2800894	261	D-LAN-19"-8	2880163	115	F-M5 12	2817987	45
			CB TM2 4A M1 P	2800883	261	D-LAN-19"-D-P	2880192	115	F-M5 12 ST	2817990	42
			CB TM2 4A SFB P	2800872	259	D-LAN-CAT.5-FP	2800723	115	F-M5 12/MT	2817974	45
			CB TM2 5A F1 P	2800895	261	D-TERMITRAB-UK 5	2794990	98	F-M5 2200/30 ST	2805392	51
<b>H</b>	CB E1 24DC/2A NO P CB E1 24DC/2A S-C P CB E1 24DC/2A S-R P CB E1 24DC/3A NC P	2800902 256 2800923 257 2800909 257 2800917 257	CB TM2 5A M1 P	2800884	261	DT-LAN-CAT.6+	2881007	114	F-M5 80 ST	2921307	48
			CB TM2 5A SFB P	2800873	259	DT-TELE-RJ45	2882925	133	F-M5-T1/T2 50 ST	2800191	34
			CB TM2 6A F1 P	2800896	261	DT-UB-485/BS	2920612	121	FBS 2-6	3030336	258
			CB TM2 6A M1 P	2800885	261	DT-UB-IB-RB0	2800056	123	FBS 2-6 BU	3036932	258
<b>I</b>	CB E1 24DC/3A NO P CB E1 24DC/3A S-C P CB E1 24DC/3A S-R P CB E1 24DC/4A NC P	2800903 256 2800924 257 2800910 257 2800918 257	CB TM2 6A SFB P	2800874	259	DT-UB-IB-RBI	2800055	122	FBS 2-6 GY	3032237	258
			CB TM2 8A F1 P	2800897	261	DT-UB-V24/S-9-SB	2803069	116	FBS 3-6	3030242	258
			CB TM2 8A M1 P	2800886	261	DT-UB-V24/S-SB-SET	2803072	117	FBS 3-6 BU	3036945	258
			CB TM2 8A SFB P	2800875	259	CBB TM 04 2X2RC P-PT	2838924	152	FBS 3-6 GY	3032240	258
<b>J</b>	CB E1 24DC/4A NO P CB E1 24DC/4A S-C P CB E1 24DC/4A S-R P CB E1 24DC/6A NC P	2800904 256 2800925 257 2800911 257 2800919 257	CBB TM 08 2X4RC P-PT	2801482	262	CM-KBL-PROG	2881557	153	FBS 4-6	3030255	258
			CHECKMASTER	2801483	262	CM-KBL-RS232/USB	2881078	153	FBS 4-6 BU	3036958	258
			CM-PA-CT10	2816959	153	CM-PA-CT10	2816959	153	FBS 4-6 GY	3032279	258
			CM-PA-CTM	2816962	153	CM-PA-CTM	2816962	153	FBS 5-6	3030349	258
<b>K</b>	CB E1 24DC/6A NO P CB E1 24DC/6A S-C P CB E1 24DC/6A S-R P CB E1 24DC/8A S-C P	2800905 256 2800926 257 2800912 257 2800927 257	CM-LAMBDA/4-0.47-BB	2800104	153	CM-PA-FLT/VAL-CP	2880392	153	FBS 5-6 GY	3032266	258
			CM-LAMBDA/4-0.47-SB	2800022	138	CM-PA-PT	2882844	153	CM-PA-PT	0903042	269
			CM-LAMBDA/4-2.25-BB	2801057	138	CM-PA-PT/A	2816933	153	CM-PA-PT/A	0903043	269
			CM-LAMBDA/4-2.25-BB	2801057	138	CM-PA-TF	2816975	153	CM-PA-TF	0903044	269
<b>L</b>	CB TM1 0.5A SFB P CB TM1 10A F1 P CB TM1 10A M1 P CB TM1 10A SFB P	2800835 259 2800865 261 2800854 260 2800843 259	CM-PA-VAL-MS	2800104	153	EC-E 0,5A DC24V	0903041	269	FBS 10-6	3030271	258
			EC-E 1A DC24V	0903042	269	EC-E 2A DC24V	0903043	269	FBS 10-6 BU	3032198	258
			EC-E 2A DC24V	0903043	269	EC-E 3A DC24V	0903044	269	FBS 10-6 GY	3032253	258
			EC-E 4A DC24V	0903045	269	EC-E 4A DC24V	0903045	269	FBS 20-6	3030365	258
<b>M</b>	CB TM1 12A F1 P CB TM1 12A M1 P CB TM1 12A SFB P CB TM1 16A F1 P	2800866 261 2800855 260 2800844 259 2800867 261	EC-E 6A DC24V	0903046	269	EC-E 1A	0903022	268	FBS 20-6 BU	3032208	258
			EC-E 8A DC24V	0903047	269	EC-E1 0,5A	0903022	268	FBS 50-6 BU	3032211	258
			EC-E 10A DC24V	0903048	269	EC-E1 10A	0903030	268	FBST 500 TMC P	0916615	274
			EC-E 12A DC24V	0903049	269	EC-E1 12A	0903031	268	FBST 500-PLC BU	2966692	268
<b>N</b>	CB TM1 16A M1 P CB TM1 16A SFB P CB TM1 1A F1 P CB TM1 1A M1 P	2800856 260 2800845 259 2800858 260 2800847 261	EC-E1 0,5A	0903022	268	EC-E1 2A	0903023	268	FBST 500 TMC-N GY	0901028	268
			EC-E1 2A	0903023	268	EC-E1 3A	0903025	268	FBST 500 TMC P	0916615	274
			EC-E1 3A	0903025	268	EC-E1 4A	0903026	268	FBST 500-PLC RD	2966786	268
			EC-E1 4A	0903026	268	EC-E1 6A	0903028	268	FL CAT6 PATCH 1,0	2891385	114
<b>O</b>	CB TM1 1A SFB P CB TM1 2A F1 P CB TM1 2A M1 P CB TM1 2A SFB P	2800836 259 2800859 261 2800848 260 2800837 259	EC-E1 6A	0903028	268	EC-E1 8A	0903029	268	FL CAT6 PATCH 1,5	2891482	127
			EC-E1 8A	0903029	268	EC-E4 0,5A	0903040	268	FLT 100 N/PE-1,5	2800303	31
			EC-E4 0,5A	0903040	268	EC-E4 10A	0903038	268	FLT-CP-1C-350	2859741	38
			EC-E4 10A	0903038	268	EC-E4 1A	0903032	268	FLT-CP-1S-350	2859738	37
<b>P</b>	CB TM1 2A SFB P CB TM1 2A F1 P CB TM1 2A M1 P CB TM1 2A SFB P	2800837 259 2765547 110 2807926 107 2807939 107 2765398 108	EC-E4 1A	0903032	268	EC-E4 2A	0903033	268	FLT-CP-2C-350	2859770	37
			EC-E4 2A	0903033	268	EC-E4 3A	0903034	268	FLT-CP-2S-350	2859767	37
			EC-E4 3A	0903034	268	EC-E4 12A	0903039	268	FLT-CP-350-ST	2881887	36
			EC-E4 12A	0903039	268	EC-E4 1A	0903032	268	FLT-CP-3C-350	2859725	36
<b>Q</b>	CB TM1 2A SFB P CB TM1 2A F1 P CB TM1 2A M1 P CB TM1 2A SFB P	2800837 259 2765547 110 2807926 107 2807939 107 2765398 108	EC-E4 1A	0903032	268	EC-E4 2A	0903033	268	FLT-CP-3S-350	2859712	36
			EC-E4 2A	0903033	268	EC-E4 3A	0903034	268	FLT-CP-N/PE-350	2859754	30
			EC-E4 3A	0903034	268	EC-E4 1A	0903032	268	EC-E4 2A	0903033	268
			EC-E4 1A	0903032	268	EC-E4 3A	0903034	268	EC-E4 4A	0903035	268



# Index

## Alphabetical

Type	Order No.	Page	Type	Order No.	Page	Type	Order No.	Page	Type	Order No.	Page
QUINT-PS/3AC/24DC/40	2866802	169	STEP-PS/1AC/48DC/2	2866880	191	TT-2-PE/S1-M-24DC	2920638	95	UPS-CP-BP-1/2/3KVA	2800291	249
QUINT-PS/3AC/48DC/20	2320827	172	STEP-PS/1AC/5DC/2	2320513	190	TT-2/2-24DC	2838173	95	UPS-CP-BP-4.5/6KVA	2800292	249
QUINT-PS/12DC/24DC/5	2320131	200	STEP-PS/48AC/24DC/0.5	2868716	187	TT-2/2-M-24DC	2920722	95	UPS-CP-MS-4X16A-IEC	2800294	249
QUINT-PS/24DC/12DC/8	2320115	199	STEP-UPS/12DC/12DC/4	2868693	232	TT-D-2-PE-M-BK	2920654	94	UPS-CP-MS-5X16A/9X10A-IEC	2800296	249
QUINT-PS/24DC/24DC/5	2320034	198	STEP-UPS/24DC/24DC/3	2868703	232	TT-D-2-PE-M-BU	2803878	95	UPS-CP-MS-9X10A-IEC	2800293	249
QUINT-PS/24DC/24DC/10	2320092	198	SVP 2E-48AC	2788919	108	TT-D-ST-BU	2856773	97	UPS-CP-PU-240AC/32A-4.5/6KV	2800297	249
QUINT-PS/24DC/24DC/10/CO	2320555	201	SVP 2E-110AC	2765534	108	TT-D-STTCCO-BK	2858894	96	UPS-CP-PU-240AC/63A-4.5/6KV	2800298	249
QUINT-PS/24DC/24DC/20	2320102	199	SVP 3E-110AC	2765521	108	TT-EX(I)-24DC	2832124	95	UPS-SNMP-CARD	2800289	248
QUINT-PS/24DC/24DC/20/CO	2320568	201	SYS N4 120/208Y	2800704	68	TT-EX(I)-M-24DC	2803865	95	UPS-SNMP-CARD E	2800290	248
QUINT-PS/24DC/24DC/5/CO	2320542	201	SYS N4 120/240HLD	2800706	69	TT-SLKK5-F/110AC	2765602	123	UT 6-TMC M 0.5A	0916603	263
QUINT-PS/24DC/48DC/5	2320128	199	SYS N4 120/240S	2800705	68	TT-SLKK5-S-12DC	2809597	99	UT 6-TMC M 10A	0916610	263
QUINT-PS/48DC/24DC/5	2320144	200	SYS N4 277/480Y	2800703	69	TT-SLKK5-S-24DC	2809607	99	UT 6-TMC M 12A	0916611	263
QUINT-PS/FAN/4	2320076	212	SYS N4 480D	2800707	69	TT-SLKK5-S-48DC	2809610	99	UT 6-TMC M 15A	0916612	263
QUINT-UPS/1AC/1AC/500VA	2320270	221	SYS N4/1 120/208Y	2800709	68	TT-SLKK5/12DC	2794893	99	UT 6-TMC M 16A	0916613	263
QUINT-UPS/24DC/24DC/5	2320212	218	SYS N4/1 120/240HLD	2800711	69	TT-SLKK5/24DC	2794903	99	UT 6-TMC M 1A	0916604	263
QUINT-UPS/24DC/24DC/5/1.3AH	2320254	230	SYS N4/1 120/240S	2800710	68	TT-SLKK5/48DC	2794916	99	UT 6-TMC M 2A	0916605	263
QUINT-UPS/24DC/24DC/10/3.4AH	2320267	230	SYS N4/1 277/480Y	2800708	69	TT-ST-2-PE-24DC	2858878	96	UT 6-TMC M 4A	0916606	263
QUINT-UPS/24DC/24DC/20	2320238	219	SYS N4/1 480D	2800712	69	TT-ST-2-PE/S2-24DC	2801458	97	UT 6-TMC M 5A	0916607	263
QUINT-UPS/24DC/12DC/5/24DC/10	2320461	220	SYS N4X 120/208Y	2800714	68	TT-ST-2/2-24DC	2858881	97	UT 6-TMC M 6A	0916608	263
QUINT-UPS/24DC/24DC/10	2320225	219	SYS N4X 120/240HLD	2800716	69	TT-ST-M-2-PE-24AC	2858920	96	UT 6-TMC M 8A	0916609	263
QUINT-UPS/24DC/24DC/40	2320241	219	SYS N4X 120/240S	2800715	68	TT-ST-M-2-PE-24DC	2858904	96	UWA 130	2901664	213
			SYS N4X 277/480Y	2800713	69	TT-ST-M-2/2-24AC	2858933	97	UWA 182/52	2938235	213
			SYS N4X 480D	2800717	69	TT-ST-M-2/2-24DC	2858917	97			
			SYS N4X/1 120/208Y	2800719	68	TT-ST-M-EX(I)-24DC	2859424	97			
			SYS N4X/1 120/240HLD	2800721	69	TT-ST-M-SFP-24AC	2858946	148			
			SYS N4X/1 120/240S	2800720	68	TT-UK5/12DC	2794686	98			
			SYS N4X/1 277/480Y	2800718	69	TT-UK5/24DC	2794699	98			
			SYS N4X/1 480D	2800722	69	TT-UK5/48DC	2794709	98			
<b>R</b>			SZS 0,6X3,5	1205053	268	TT-UJK5-M/24DC	2795960	99	VAL-CP-175-ST	2859628	40
RAD-ADP-NM-SMA/F	2917036	137	SZS 1,0X4,0 VDE	1205066	263	TT-UJK5-M/48DC	2795973	99	VAL-CP-1S-175	2859479	41
RAD-PIG-EF316-MCX-N	2867681	137				TT-UJK5-M/60DC	2795986	99	VAL-CP-1S-350	2859563	41
									VAL-CP-1S-350/O	2881036	41
									VAL-CP-2C-175	2859482	41
									VAL-CP-2C-350	2859589	41
									VAL-CP-2C-350/O	2881052	41
									VAL-CP-2S-175	2859495	41
									VAL-CP-2S-350	2859505	41
									VAL-CP-2S-350/O	2881049	41
									VAL-CP-350-ST	2859602	36
									VAL-CP-350-ST-GY	2882718	52
									VAL-CP-3C-175	2859466	40
									VAL-CP-3C-350	2859547	40
									VAL-CP-3C-350/O	2881023	40
									VAL-CP-3S-175	2859453	40
									VAL-CP-3S-350	2859521	40
									VAL-CP-3S-350/O	2881010	40
									VAL-CP-MCB-1S-350/40/FM	2882763	55
									VAL-CP-MCB-3C-350/40/FM	2882776	55
									VAL-CP-MCB-3S-350/40/FM	2882750	54
									VAL-CP-MOSO 60-3C-FM	2804416	53
									VAL-CP-MOSO 60-3S-FM	2804403	53
									VAL-CP-N/PE-350-ST	2859699	40
									VAL-CP-N/PE-350-ST-GY	2882734	52
									VAL-CP-RCD-3S/40/0.03	2882802	52
									VAL-CP-RCD-3S/40/0.3/SEL	2808001	52
									VAL-MS 60 ST	2807573	44
									VAL-MS 1000DC-PV-ST	2800624	64
									VAL-MS 1000DC-PV2+V	2800628	64
									VAL-MS 1000DC-PV2+V-FM	2800627	64
									VAL-MS 120 ST	2807586	46
									VAL-MS 230	2839127	44
									VAL-MS 230 IT ST	2807599	46
									VAL-MS 230 ST	2798844	42
									VAL-MS 230/1+1	2804429	43
									VAL-MS 230/1+1-FM	2804432	43
									VAL-MS 230/2+0	2800103	43
									VAL-MS 230/2+0-FM	2800102	43
									VAL-MS 230/3+1	2838209	42
									VAL-MS 230/3+1 FM	2838199	42
									VAL-MS 230FM	2839130	44
									VAL-MS 320 ST	2838843	42
									VAL-MS 320-UD ST	2858315	42
									VAL-MS 320/1+1	2804380	43
									VAL-MS 320/1+1-FM	2804393	43
									VAL-MS 320/3+0	2920230	43
									VAL-MS 320/3+0-FM	2920243	43
									VAL-MS 320/3+1	2859178	42
									VAL-MS 320/3+1/FM	2859181	42
									VAL-MS 320/3+1/FM-UD	2856689	42
									VAL-MS 350 VF ST	2856595	45
QUINT-PS/1AC/48DC/2	2866880	191	STEP-PS/1AC/5DC/2	2320513	190	TT-2/2-24DC	2838173	95	UPS-CP-BP-1/2/3KVA	2800291	249
QUINT-PS/1AC/5DC/2	2320513	190	STEP-PS/48AC/24DC/0.5	2868716	187	TT-2/2-M-24DC	2920722	95	UPS-CP-BP-4.5/6KVA	2800292	249
STEP-PS/1AC/24DC/10	2868541	191	STEP-UPS/12DC/12DC/4	2868693	232	TT-D-2-PE-M-BK	2920654	94	UPS-CP-MS-4X16A-IEC	2800294	249
STEP-PS/1AC/24DC/10	2868538	192	STEP-UPS/24DC/24DC/3	2868703	232	TT-D-2-PE-M-BU	2803878	95	UPS-CP-MS-9X10A-IEC	2800293	249
STEP-PS/1AC/24DC/5	2868570	193	SVP 2E-48AC	2788919	108	TT-D-ST-BU	2856773	97	UPS-CP-PU-240AC/32A-4.5/6KV	2800297	249
STEP-PS/1AC/24DC/5	2868583	193	SVP 2E-110AC	2765534	108	TT-D-STTCCO-BK	2858894	96	UPS-CP-PU-240AC/63A-4.5/6KV	2800298	249
STEP-PS/1AC/24DC/5	2868583	193	SVP 3E-110AC	2765521	108	TT-EX(I)-24DC	2832124	95	UPS-SNMP-CARD	2800289	248
STEP-PS/1AC/15DC/4	2868619	193	SYS N4 120/208Y	2800704	68	TT-EX(I)-M-24DC	2803865	95	UPS-SNMP-CARD E	2800290	248
STEP-PS/1AC/24DC/2.5	2868606	211	SYS N4 120/240HLD	2800706	69	TT-SLKK5-F/110AC	2765602	123	UT 6-TMC M 0.5A	0916603	263
STEP-PS/1AC/24DC/1.5	2868554	192	SYS N4 120/240S	2800705	68	TT-SLKK5-S-12DC	2809597	99	UT 6-TMC M 10A	0916610	263
STEP-PS/1AC/24DC/1.5	2868570	193	SYS N4 277/480Y	2800703	69	TT-SLKK5-S-24DC	2809607	99	UT 6-TMC M 12A	0916611	263
STEP-PS/1AC/24DC/3	2868570	193	SYS N4 480D	2800707	69	TT-SLKK5-S-48DC	2809610	99	UT 6-TMC M 15A	0916612	263
STEP-PS/1AC/24DC/5	2868583	193	SYS N4/1 120/208Y	2800709	68	TT-SLKK5/12DC	2794893	99	UT 6-TMC M 16A	0916613	263
STEP-PS/1AC/24DC/5	2868583	193	SYS N4/1 120/240HLD	2800711	69	TT-SLKK5/24DC	2794903	99	UT 6-TMC M 1A	0916604	263
STEP-PS/1AC/24DC/5	2868583	193	SYS N4/1 120/240S	2800710	68	TT-SLKK5/48DC	2794916	99	UT 6-TMC M 2A	0916605	263
STEP-PS/1AC/24DC/5	2868583	193	SYS N4/1 277/480Y	2800708	69	TT-ST-2-PE-24DC	2858878	96	UT 6-TMC M 4A	0916606	263
STEP-PS/1AC/24DC/5	2868583	193	SYS N4/1 480D	2800712	69	TT-ST-2-PE/S2-24DC	2801458	97	UT 6-TMC M 5A	0916607	263
STEP-PS/1AC/24DC/5	2868583	193	SYS N4X 120/208Y	2800714	68	TT-ST-2/2-24DC	2858881	97	UT 6-TMC M 6A	0916608	263
STEP-PS/1AC/24DC/5	2868583	193	SYS N4X 120/240HLD	2800716	69</						

Type	Order No.	Page	Type	Order No.	Page
VAL-MS 350 VF/FM	2856579	45			
VAL-MS 350VF	2856582	45			
VAL-MS 385/65 ST	2920308	48			
VAL-MS 385/65/1+1	2921255	49			
			<b>W</b>		
VAL-MS 385/65/1+1-FM	2921242	49	WS UT 6	3047345	263
VAL-MS 385/65/3+0	2921019	49	WT-RJ 12-S/FM A/K AP	2809186	131
VAL-MS 385/65/3+0-FM	2921006	49	WT-RJ 45-S/ISDN1/K AP	2809830	127
VAL-MS 385/65/3+1	2920890	48			
			<b>Z</b>		
VAL-MS 385/65/3+1-FM	2920887	48	ZB 12,LGS:L1-N,PE	0812146	111
VAL-MS 385/80 ST	2920353	48	ZB 12:UNPRINTED	0812120	111
VAL-MS 385/80/1+1	2921297	49	ZB 22 CUS	0824949	141
VAL-MS 385/80/1+1-FM	2921284	49	ZB 5 :UNBEDRUCKT	1050004	111
			ZB 5,LGS:FORTL.ZAHLEN	1050017	111
VAL-MS 385/80/3+0	2921093	49	ZB 5,LGS:L1-N,PE	1050415	111
VAL-MS 385/80/3+0-FM	2921080	49	ZB 6,LGS:FORTL.ZAHLEN	1051016	111
VAL-MS 385/80/3+1	2920971	48	ZB 6,LGS:L1-N,PE	1051414	111
VAL-MS 385/80/3+1-FM	2920968	48	ZB 6:UNBEDRUCKT	1051003	111
			ZBF 12:UNBEDRUCKT	0809735	63
VAL-MS 400 ST	2816399	46	ZBF 15:UNBEDRUCKT	0811202	111
VAL-MS 500 ST	2807609	46	ZBF 5,LGS:FORTL.ZAHLEN	0808671	111
VAL-MS 580-ST	2920434	43	ZBF 5:UNBEDRUCKT	0808642	111
VAL-MS 580/3+0	2920450	43	ZBF 6,LGS:FORTL.ZAHLEN	0808749	111
			ZBF 6:UNBEDRUCKT	0808710	111
VAL-MS 580/3+0-FM	2920447	43	ZBFM 5 WH:UNBEDRUCKT	0803595	63
VAL-MS 60	2868020	44	ZBN 18 CUS	0825059	63
VAL-MS 60/FM	2868033	44	ZBN 18,LGS:ERDE	2749589	63
VAL-MS 600DC-PV-ST	2800623	64	ZBN 18,LGS:L1-N,ERDE	2749576	63
			ZBN 18:UNBEDRUCKT	2809128	63
VAL-MS 600DC-PV/2+V	2800642	64	ZP-J/TAE/ST550 WH	2830362	59
VAL-MS 600DC-PV/2+V-FM	2800641	64			
VAL-MS 75 VF ST	2805318	50			
VAL-MS 750/30-ST	2920256	51			
VAL-MS 750/30/3+0	2920269	51			
VAL-MS 750/30/3+0-FM	2920272	51			
VAL-MS 800/30 VF/FM	2805402	51			
VAL-MS BE	2817741	44			
VAL-MS BE/FM	2817738	44			
VAL-MS-T1/T2 1000DC-PV-ST	2801162	64			
VAL-MS-T1/T2 1000DC-PV/2+V	2801160	64			
VAL-MS-T1/T2 1000DC-PV/2+V-FM	2801161	64			
VAL-MS-T1/T2 175/12.5 ST	2800676	34			
VAL-MS-T1/T2 175/12.5/1+0	2801043	35			
VAL-MS-T1/T2 175/12.5/1+0-FM	2801044	35			
VAL-MS-T1/T2 175/12.5/1+1	2800675	35			
VAL-MS-T1/T2 175/12.5/1+1-FM	2800674	35			
VAL-MS-T1/T2 175/12.5/3+0	2800673	35			
VAL-MS-T1/T2 175/12.5/3+0-FM	2800672	35			
VAL-MS-T1/T2 175/12.5/3+1	2800671	34			
VAL-MS-T1/T2 175/12.5/3+1-FM	2800670	34			
VAL-MS-T1/T2 335/12.5 ST	2800190	34			
VAL-MS-T1/T2 335/12.5/1+0	2801041	35			
VAL-MS-T1/T2 335/12.5/1+0-FM	2801042	35			
VAL-MS-T1/T2 335/12.5/1+1	2800187	35			
VAL-MS-T1/T2 335/12.5/1+1-FM	2800186	35			
VAL-MS-T1/T2 335/12.5/3+0	2800189	35			
VAL-MS-T1/T2 335/12.5/3+0-FM	2800188	35			
VAL-MS-T1/T2 335/12.5/3+1	2800184	34			
VAL-MS-T1/T2 335/12.5/3+1-FM	2800183	34			
VAL-MS-T1/T2 335/12.5/4+0	2800645	34			
VAL-MS-T1/T2 335/12.5/4+0-FM	2800644	34			
VAL-MS-T1/T2 48/12.5 ST	2801242	35			
VAL-MS-T1/T2 48/12.5/1+0	2801241	35			
VAL-MS-T1/T2 48/12.5/1+0-FM	2801240	35			
VAL-MS-T1/T2 600DC-PV-ST	2801165	64			
VAL-MS-T1/T2 600DC-PV/2+V	2801163	64			
VAL-MS-T1/T2 600DC-PV/2+V-FM	2801164	64			
VAL-MS/2+0-BE	2804584	46			
VAL-MS/2+0-BE/FM	2805321	46			
VAL-MS/2+0-BE/FM/S2	2800246	50			
VAL-MS/3+0-BE	2881816	46			
VAL-MS/3+0-BE/FM	2881803	46			
VAL-US 120 ST	2800739	47			
VAL-US 240 ST	2800740	47			
VAL-US 277 ST	2800741	47			
VAL-US 347 ST	2800742	47			
VAL-US 480 ST	2800743	47			
VAL-US 60 ST	2800738	47			
VIP-CAB-FLK16/FR/FR/0,14/0,5M	2900154	90			
VIP-CAB-FLK16/FR/FR/0,14/1,0M	2900155	90			
VIP-CAB-FLK16/FR/FR/0,14/2,0M	2900156	90			

