

CGHV38375F

400 W, 2.75 - 3.75 GHz, Internally-Matched, GaN-on-Silicon Carbide Transistor (IM-FET)

Description

WolfSpeed's CGHV38375F is a packaged, 400 W HPA matched to 50 ohms at both input and output ports. The CGHV38375F operates from 2.75 - 3.75 GHz providing coverage over the entire S-Band radar band. This high-power amplifier provides >10 dB of large signal gain and 40% power-added efficiency and is ideally suited as a high-power building block supporting both pulsed and CW radar applications.



Package Type: 440226
PN: CGHV38375F

Typical Performance Over 2.75 - 3.75 GHz ($T_c = 25^\circ\text{C}$)

Parameter	2.75 GHz	2.9 GHz	3.3 GHz	3.5 GHz	3.75 GHz	Units
Small Signal Gain ^{1,2}	10.0	12.5	12.6	12.6	13.5	dB
Output Power ^{1,3}	55.9	57.4	57.5	57.7	56.8	dBm
Power Gain ^{1,3}	9.9	11.4	11.5	11.7	10.8	dB
Drain Efficiency ^{1,3}	50	67	62	60	60	%

Note:

1 $V_{DD} = 50\text{ V}$, $I_{DQ} = 500\text{ mA}$

2 Measured at $P_{IN} = -10\text{ dBm}$

3 Measured at $P_{IN} = 46\text{ dBm}$ and $100\ \mu\text{s}$; Duty Cycle = 10%

Features

- Full S-Band Radar Coverage
- 400 W Typical P_{SAT}
- 55% Typical Drain Efficiency
- >10 dB Large Signal Gain
- Pulsed and CW Operation

Note: Features are typical performance across frequency under 25°C , pulsed operation. Please reference performance charts for additional details.

Applications

- Civil and Military, Pulsed and CW S-Band Radar

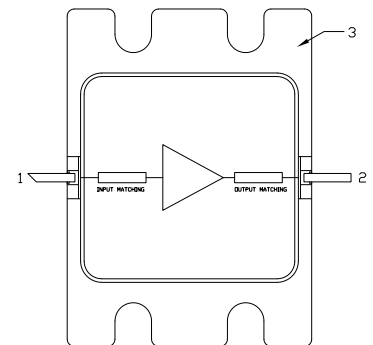

Figure 1.





Absolute Maximum Ratings (not simultaneous) at 25°C

Parameter	Symbol	Rating	Units	Conditions
Drain-source Voltage	V_{DSS}	150	V_{DC}	25°C
Gate-source Voltage	V_{GS}	-10, +2		
Storage Temperature	T_{STG}	-55, +150	°C	
Maximum Forward Gate Current	I_G	80	mA	25°C
Maximum Drain Current	I_{DMAX}	24	A	
Soldering Temperature	T_S	260	°C	MTTF > 1e6 Hours
Junction Temperature	T_J	225		

Electrical Characteristics (Frequency = 2.75 GHz to 3.75 GHz unless otherwise stated; $T_c = 25^\circ\text{C}$)

Characteristics	Symbol	Min.	Typ.	Max.	Units	Conditions
DC Characteristics						
Gate Threshold Voltage	$V_{GS(th)}$	-3.8	-3.0	-2.3	V	$V_{DS} = 10\text{ V}$, $I_D = 83.6\text{ mA}$
Gate Quiescent Voltage	$V_{GS(Q)}$	—	-2.7	—	V_{DC}	$V_{DD} = 28\text{ V}$, $I_{DQ} = 500\text{ mA}$
Saturated Drain Current ¹	I_{DS}	54.4	77.7	—	A	$V_{DS} = 6.0\text{ V}$, $V_{GS} = 2.0\text{ V}$
Drain-Source Breakdown Voltage	V_{BD}	125	—	—	V	$V_{GS} = -8\text{ V}$, $I_D = 83.6\text{ mA}$
RF Characteristics²						
Small Signal Gain	S_{21_1}	—	12.5	—	dB	$P_{IN} = -10\text{ dBm}$
Output Power at 2.75 GHz	P_{OUT1}	—	55.9	—	dBm	$V_{DD} = 50\text{ V}$, $I_{DQ} = 500\text{ mA}$, $P_{IN} = 46\text{ dBm}$
Output Power at 2.9 GHz	P_{OUT2}	—	57.4	—		
Output Power at 3.3 GHz	P_{OUT3}	—	57.5	—		
Output Power at 3.5 GHz	P_{OUT4}	—	57.7	—		
Output Power at 3.75 GHz	P_{OUT5}	—	56.8	—		
Drain Efficiency at 2.75 GHz	DE_1	—	50	—	%	
Drain Efficiency at 2.9 GHz	DE_2	—	67	—		
Drain Efficiency at 3.3 GHz	DE_3	—	62	—		
Drain Efficiency at 3.5 GHz	DE_4	—	60	—		
Drain Efficiency at 3.75 GHz	DE_5	—	60	—		
Power Gain at 2.75 GHz	G_{P2}	—	9.9	—	dB	
Power Gain at 2.9 GHz	G_{P3}	—	11.4	—		
Power Gain at 3.3 GHz	G_{P4}	—	11.5	—		
Power Gain at 3.5 GHz	G_{P5}	—	11.7	—		
Power Gain at 3.75 GHz	G_{P6}	—	10.8	—		



Electrical Characteristics (Frequency = 2.75 GHz to 3.75 GHz unless otherwise stated; $T_c = 25^\circ\text{C}$)

Characteristics	Symbol	Typ.	Max.	Units	Conditions
RF Characteristics²					
Input Return Loss	S11	-6	–	dB	$P_{IN} = -10\text{ dBm}$
Output Return Loss	S22	-6	–		
Output Mismatch Stress	VSWR	–	5:1	Ψ	No damage at all phase angles

Notes:

¹ Scaled from PCM data

² Unless otherwise noted: Pulse Width = 100 μs , Duty Cycle = 10%

Thermal Characteristics

Parameter	Symbol	Rating	Units	Conditions
Operating Junction Temperature	T_J	177	$^\circ\text{C}$	Pulse Width = 100 μs , Duty Cycle = 10%, $P_{DISS} = 418\text{ W}$, $T_{CASE} = 85^\circ\text{C}$
Thermal Resistance, Junction to Case	$R_{\theta JC}$	0.22	$^\circ\text{C/W}$	
Operating Junction Temperature	T_J	185	$^\circ\text{C}$	CW, $P_{DISS} = 200\text{ W}$, $T_{CASE} = 85^\circ\text{C}$
Thermal Resistance, Junction to Case	$R_{\theta JC}$	0.5	$^\circ\text{C/W}$	

Typical Performance of the CGHV38375F

Test conditions unless otherwise noted: $V_D = 50\text{ V}$, $I_{DQ} = 500\text{ mA}$, Pulse Width = $100\ \mu\text{s}$, Duty Cycle = 10%, $P_{IN} = 46\text{ dBm}$, $T_{BASE} = +25^\circ\text{C}$

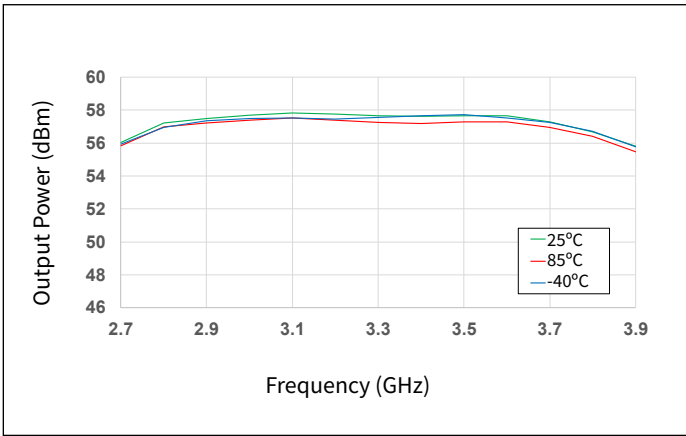

Figure 1. Output Power vs Frequency as a Function of Temperature

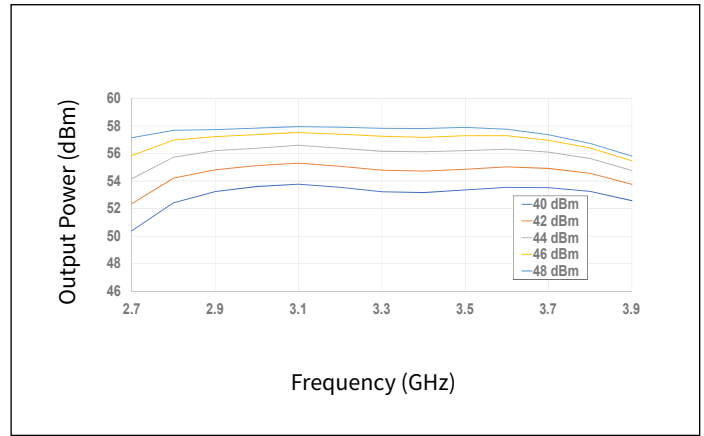

Figure 2. Output Power vs Frequency as a Function of Input Power

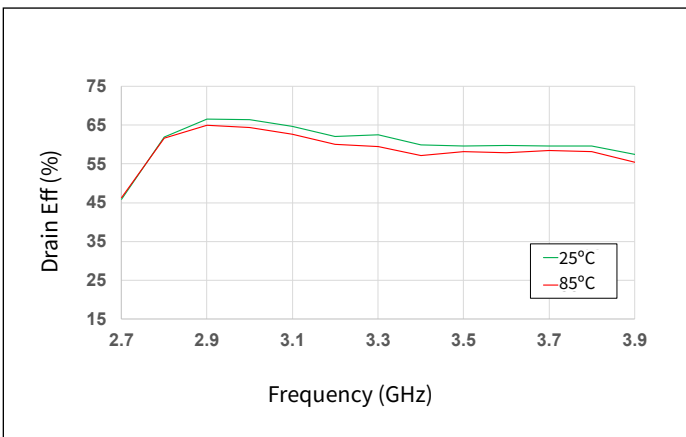

Figure 3. Drain Eff. vs Frequency as a Function of Temperature

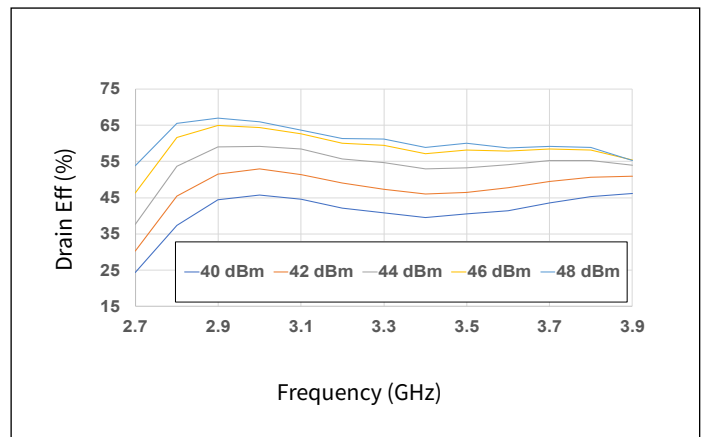

Figure 4. Drain Eff. vs Frequency as a Function of Input Power

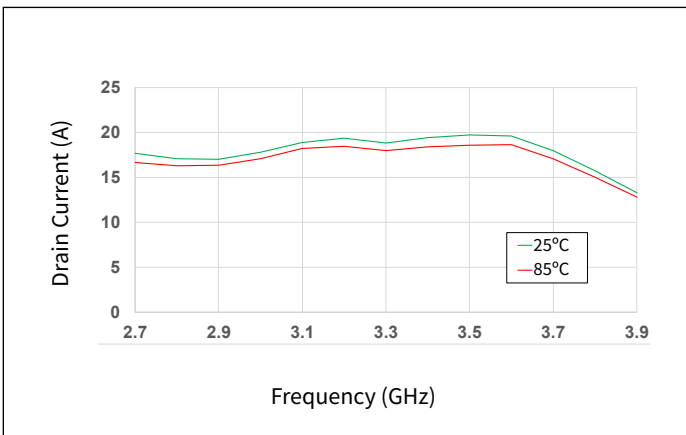

Figure 5. Drain Current vs Frequency as a Function of Temperature

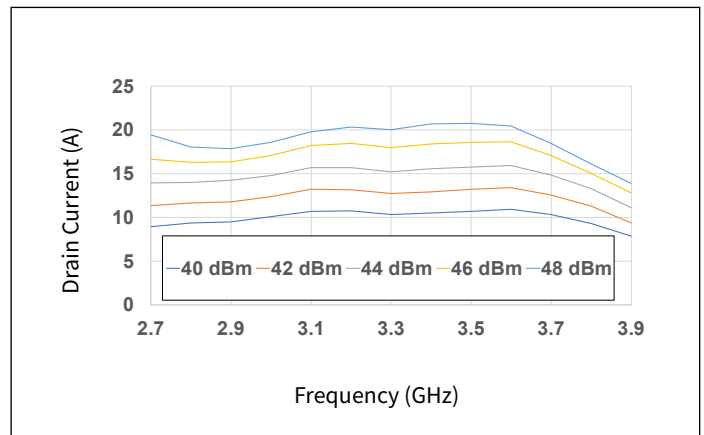

Figure 6. Drain Current vs Frequency as a Function of Input Power



Typical Performance of the CGHV38375F

Test conditions unless otherwise noted: $V_D = 50\text{ V}$, $I_{DQ} = 500\text{ mA}$, Pulse Width = $100\ \mu\text{s}$, Duty Cycle = 10%, $P_{IN} = 46\text{ dBm}$, $T_{BASE} = +25^\circ\text{C}$

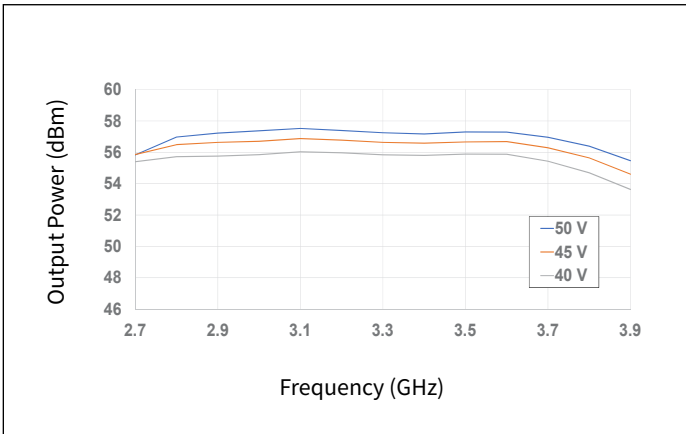

Figure 7. Output Power vs Frequency as a Function of V_D

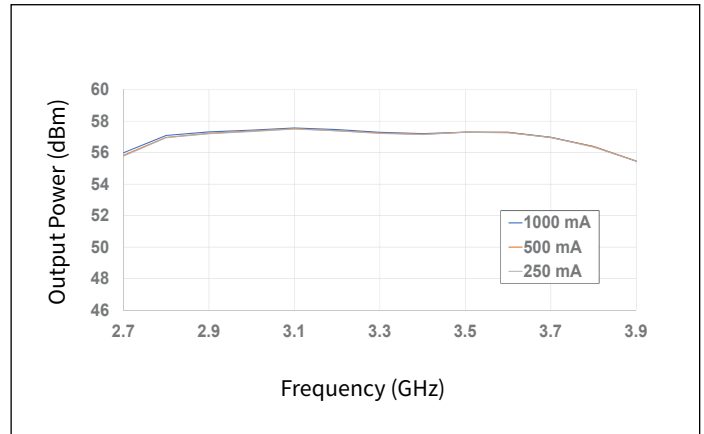

Figure 8. Output Power vs Frequency as a Function of I_{DQ}

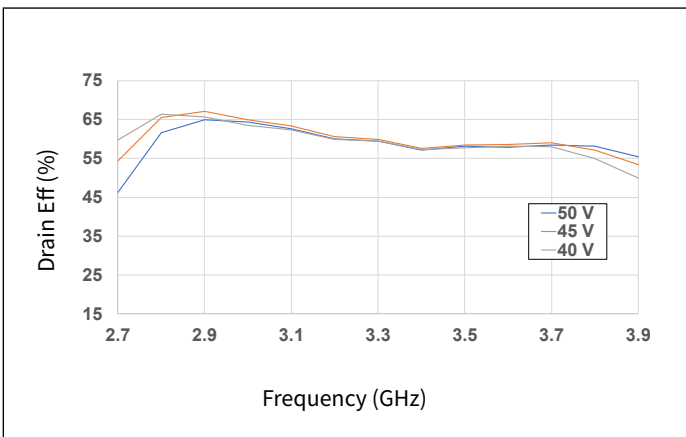

Figure 9. Drain Eff. vs Frequency as a Function of V_D

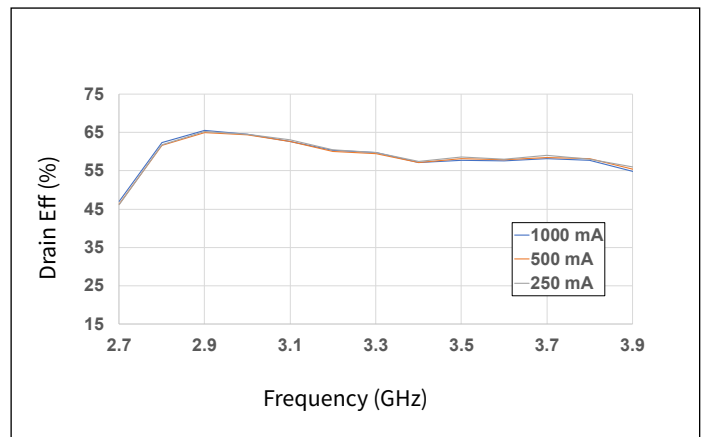

Figure 10. Drain Eff. vs Frequency as a Function of I_{DQ}

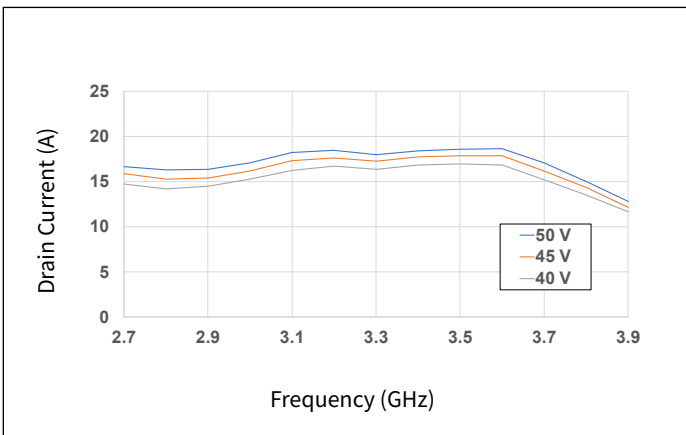

Figure 11. Drain Current vs Frequency as a Function of V_D

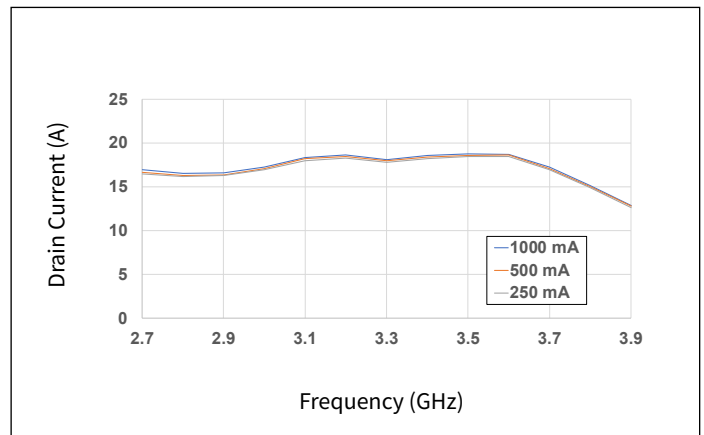

Figure 12. Drain Current vs Frequency as a Function of I_{DQ}

Typical Performance of the CGHV38375F

Test conditions unless otherwise noted: $V_D = 50\text{ V}$, $I_{DQ} = 500\text{ mA}$, Pulse Width = $100\text{ }\mu\text{s}$, Duty Cycle = 10%, $P_{IN} = 46\text{ dBm}$, $T_{BASE} = +25^\circ\text{C}$

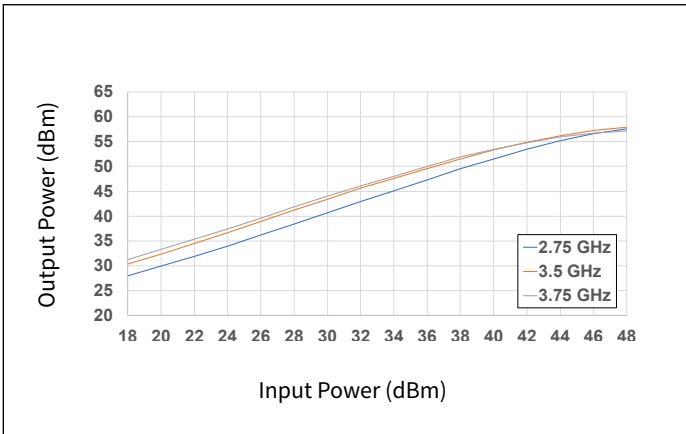

Figure 13. Output Power vs Input Power as a Function of Frequency

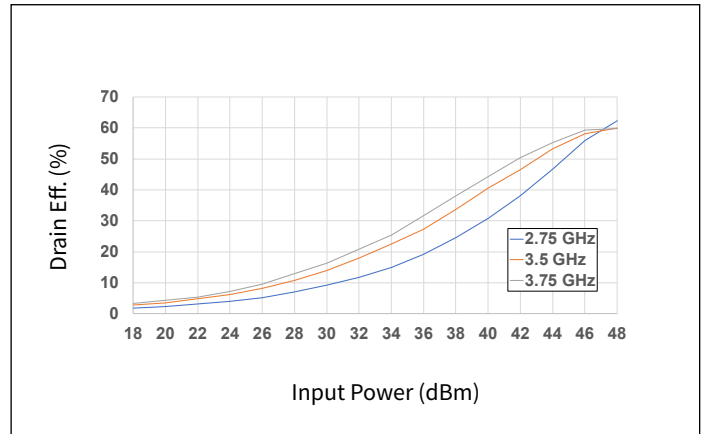

Figure 14. Drain Eff. vs Input Power as a Function of Frequency

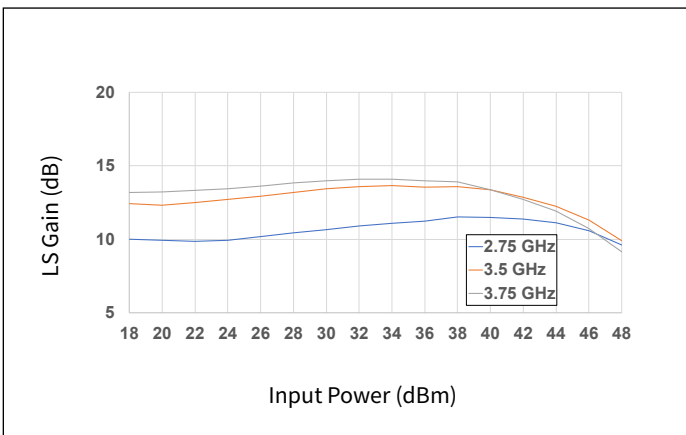

Figure 15. Large Signal Gain vs Input Power as a Function of Frequency

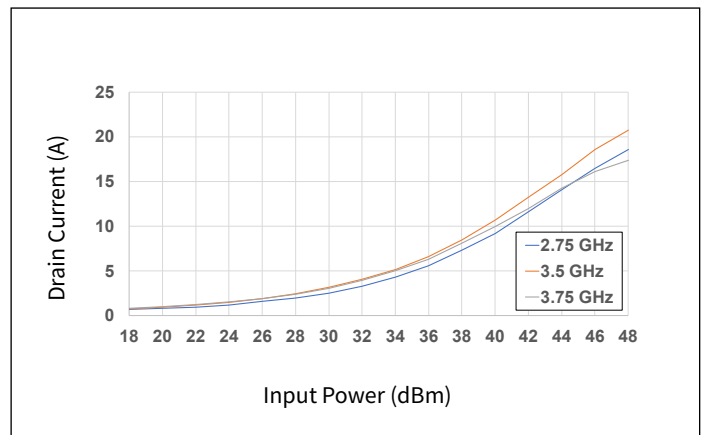

Figure 16. Drain Current vs Input Power as a Function of Frequency

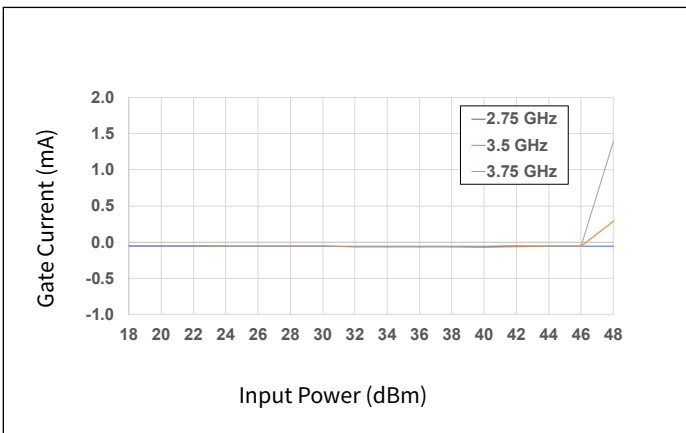

Figure 17. Gate Current vs Input Power as a Function of Frequency



Typical Performance of the CGHV38375F

Test conditions unless otherwise noted: $V_D = 50\text{ V}$, $I_{DQ} = 500\text{ mA}$, Pulse Width = 100 μs , Duty Cycle = 10%, $P_{IN} = 46\text{ dBm}$, $T_{BASE} = +25^\circ\text{C}$

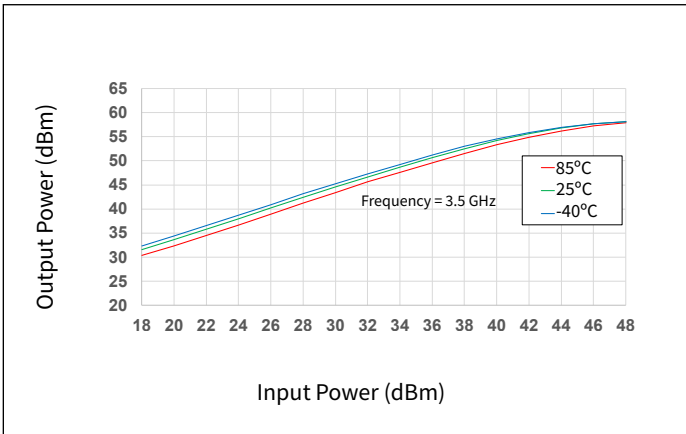

Figure 18. Output Power vs Input Power as a Function of Temperature

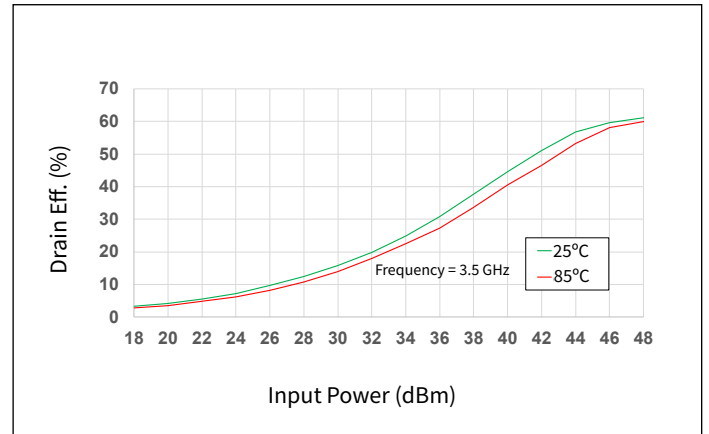

Figure 19. Drain Eff. vs Input Power as a Function of Temperature

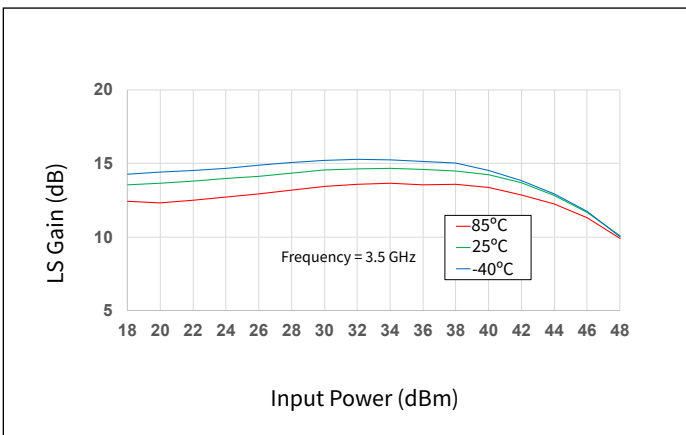

Figure 20. Large Signal Gain vs Input Power as a Function of Temperature

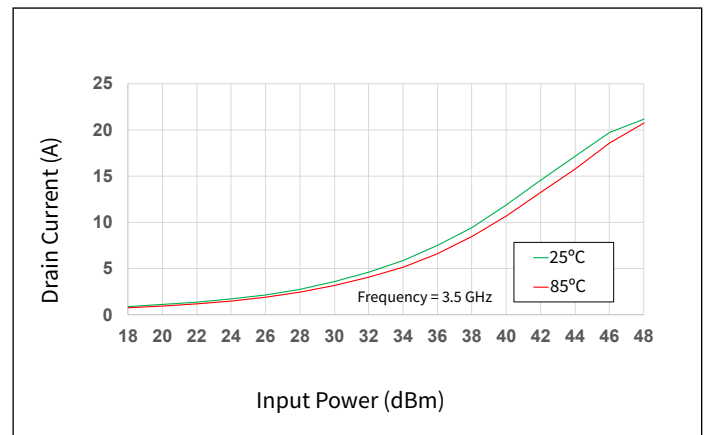

Figure 21. Drain Current vs Input Power as a Function of Temperature

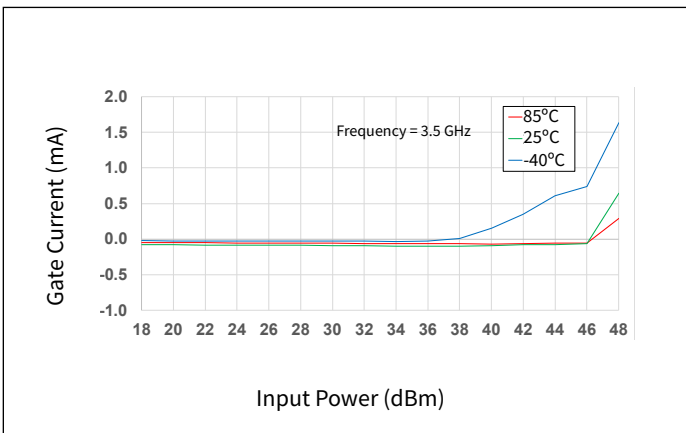

Figure 22. Gate Current vs Input Power as a Function of Temperature

Typical Performance of the CGHV38375F

Test conditions unless otherwise noted: $V_D = 50\text{ V}$, $I_{DQ} = 500\text{ mA}$, Pulse Width = $100\text{ }\mu\text{s}$, Duty Cycle = 10%, $P_{IN} = 46\text{ dBm}$, $T_{BASE} = +25^\circ\text{C}$

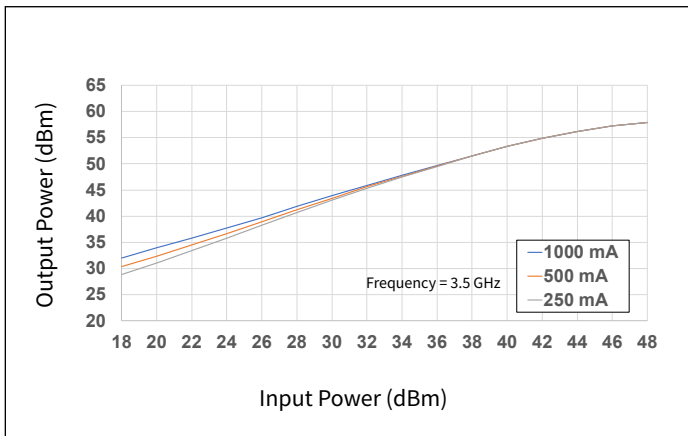

Figure 23. Output Power vs Input Power as a Function of I_{DQ}

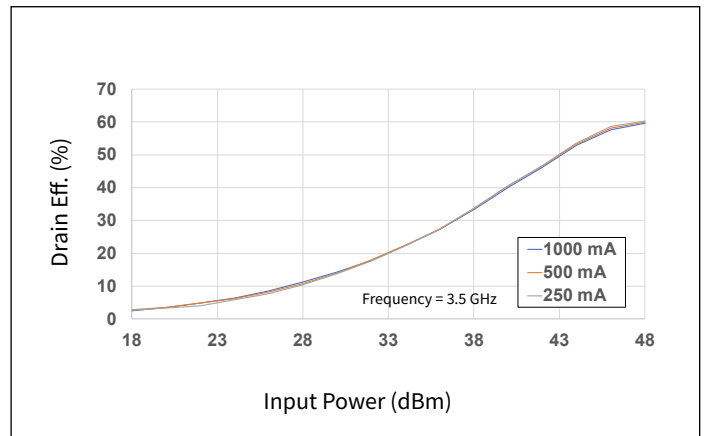

Figure 24. Drain Eff. vs Input Power as a Function of I_{DQ}

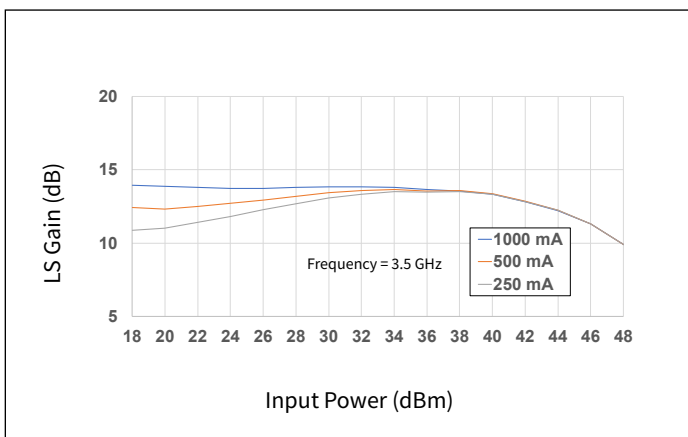

Figure 25. Large Signal Gain vs Input Power as a Function of I_{DQ}

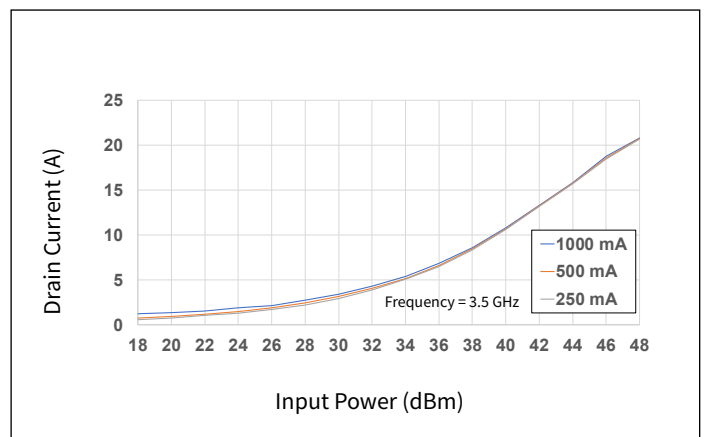

Figure 26. Drain Current vs Input Power as a Function of I_{DQ}

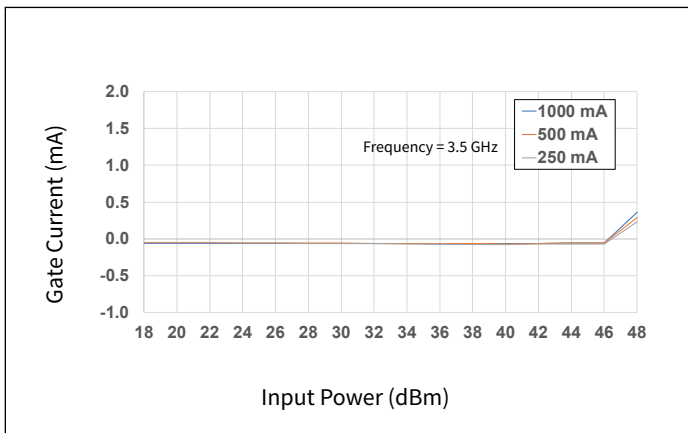

Figure 27. Gate Current vs Input Power as a Function of I_{DQ}

Typical Performance of the CGHV38375F

Test conditions unless otherwise noted: $V_D = 50\text{ V}$, $I_{DQ} = 500\text{ mA}$, CW, $P_{IN} = 43\text{ dBm}$, $T_{BASE} = +25^\circ\text{C}$

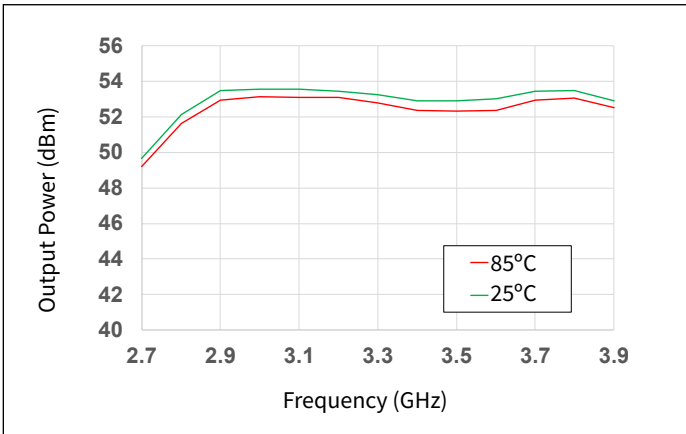

Figure 28. Output Power vs Frequency as a Function of Temperature

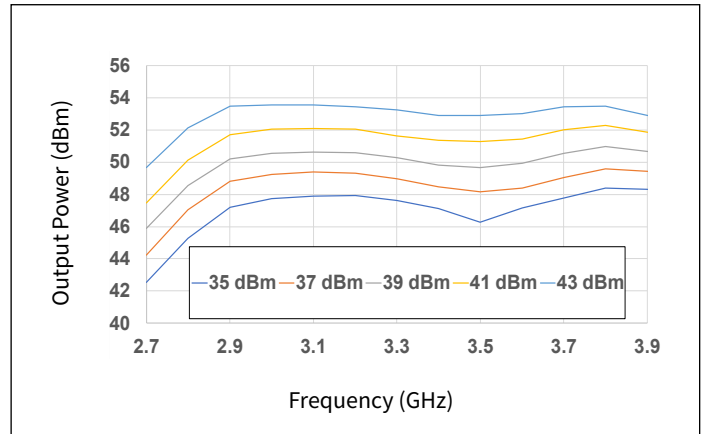

Figure 29. Output Power vs Frequency as a Function of Input Power

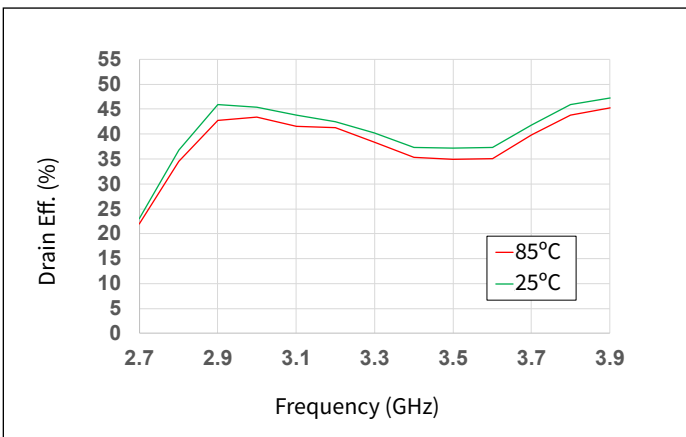

Figure 30. Drain Eff. vs Frequency as a Function of Temperature

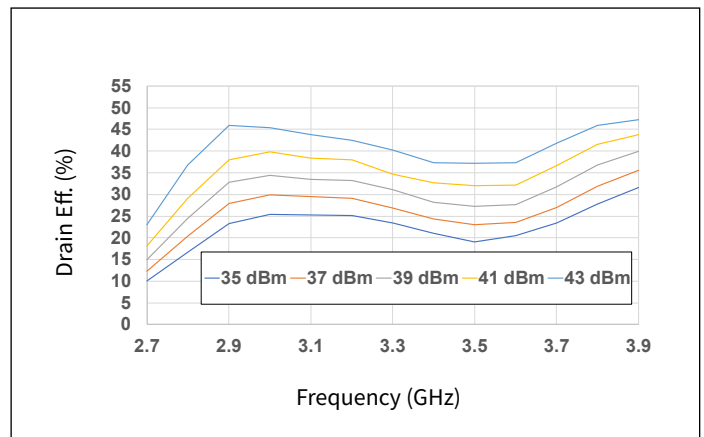

Figure 31. Drain Eff. vs Frequency as a Function of Input Power

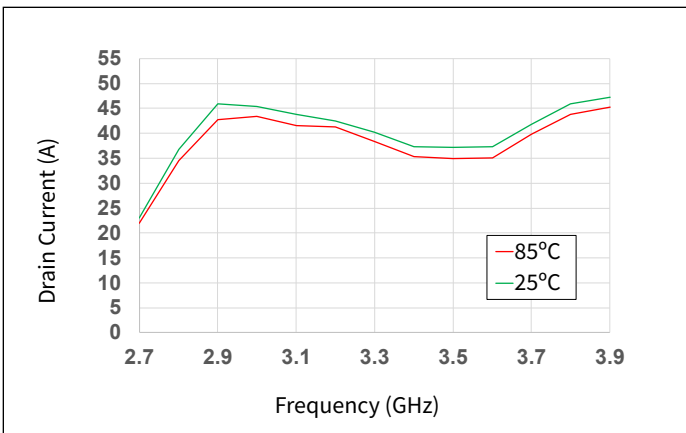

Figure 32. Drain Current vs Frequency as a Function of Temperature

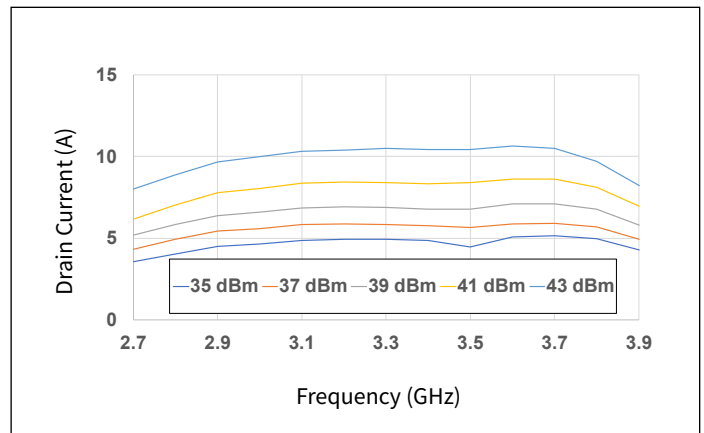

Figure 33. Drain Current vs Frequency as a Function of Input Power



Typical Performance of the CGHV38375F

Test conditions unless otherwise noted: $V_D = 50\text{ V}$, $I_{DQ} = 500\text{ mA}$, CW, $P_{IN} = 43\text{ dBm}$, $T_{BASE} = +25^\circ\text{C}$

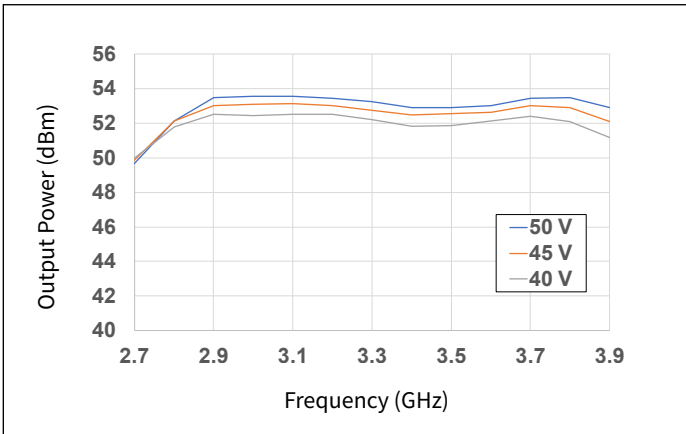

Figure 34. Output Power vs Frequency as a Function of Voltage

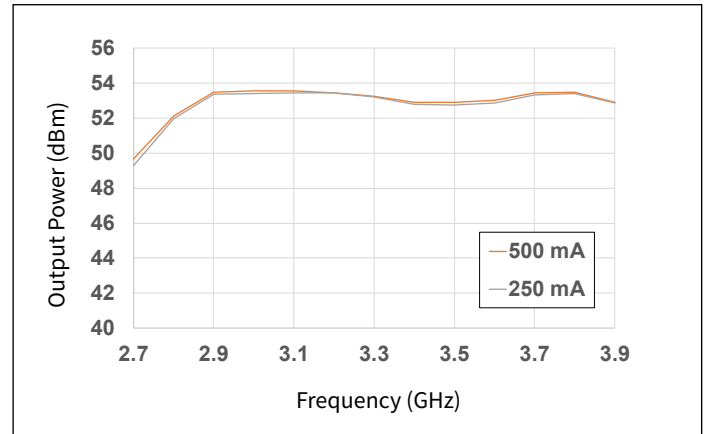

Figure 35. Output Power vs Frequency as a Function of I_{DQ}

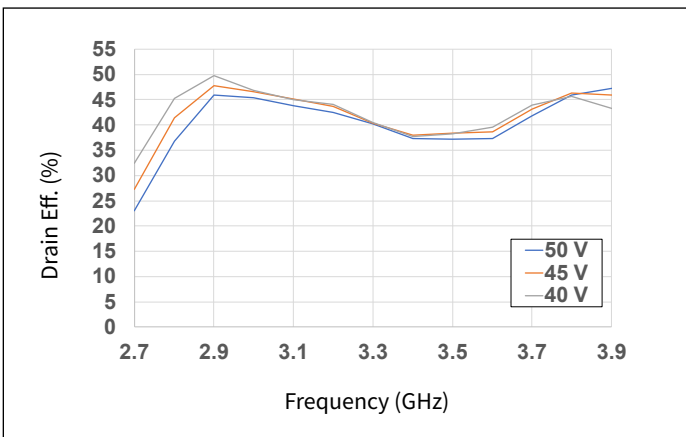

Figure 36. Drain Eff. vs Frequency as a Function of Voltage

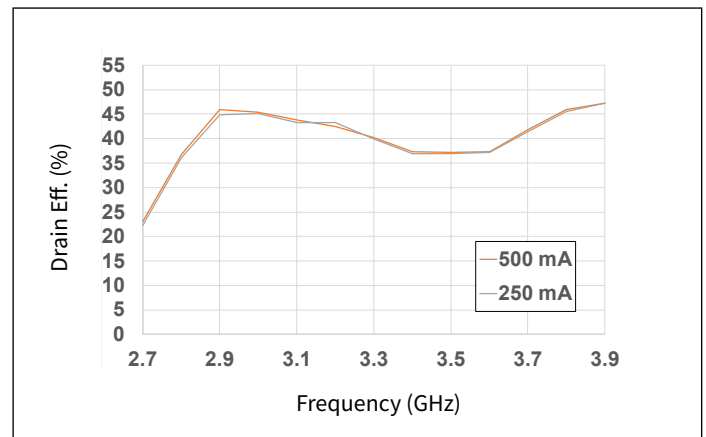

Figure 37. Drain Eff. vs Frequency as a Function of I_{DQ}

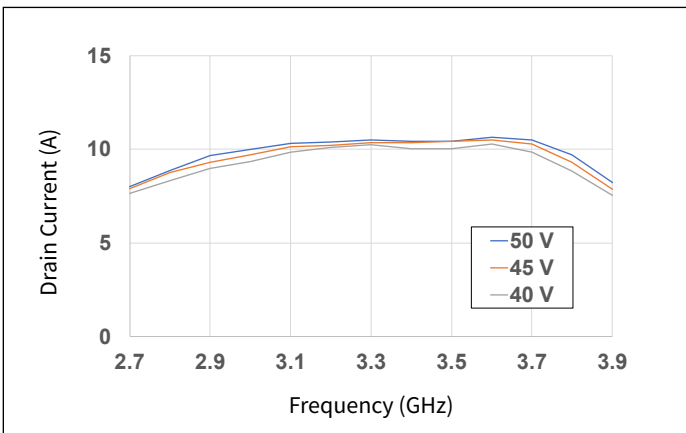

Figure 38. Drain Current vs Frequency as a Function of Voltage

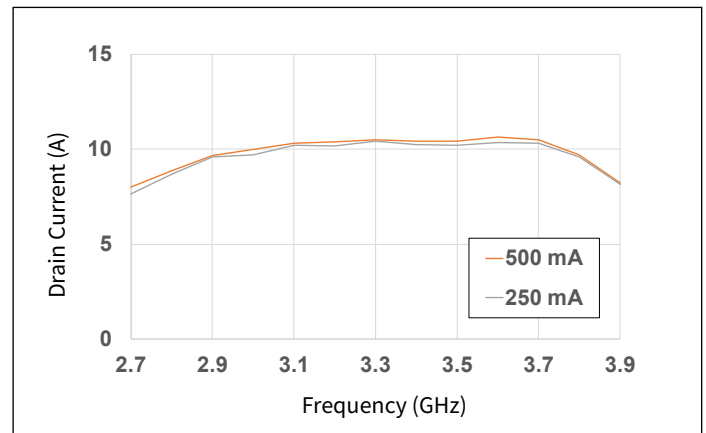

Figure 39. Drain Current vs Frequency as a Function of I_{DQ}



Typical Performance of the CGHV38375F

Test conditions unless otherwise noted: $V_D = 50\text{ V}$, $I_{DQ} = 500\text{ mA}$, CW, $P_{IN} = 43\text{ dBm}$, $T_{BASE} = +25^\circ\text{C}$

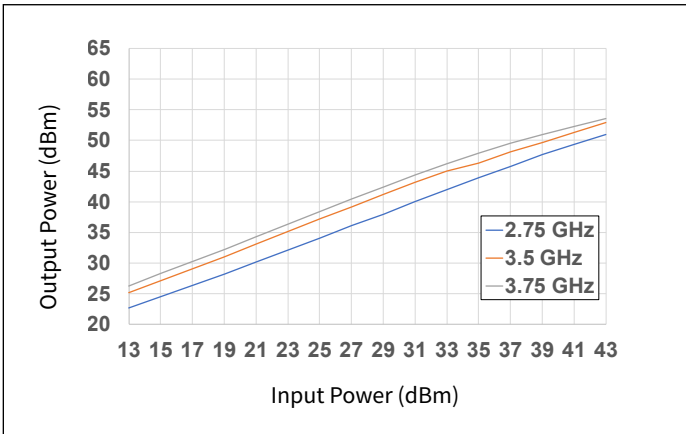

Figure 40. Output Power vs Input Power as a Function of Frequency

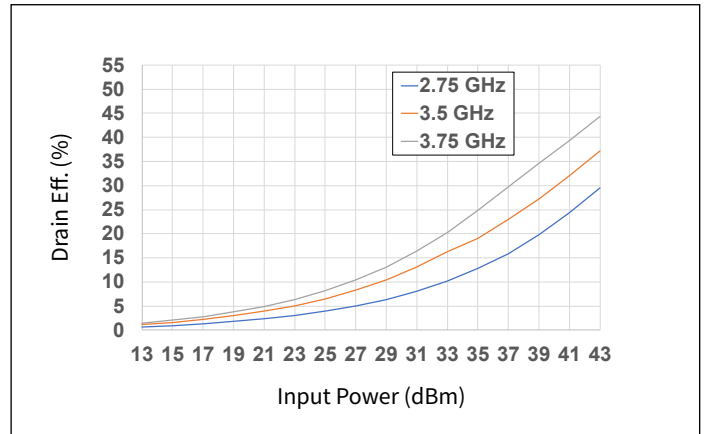

Figure 41. Drain Eff. vs Input Power as a Function of Frequency

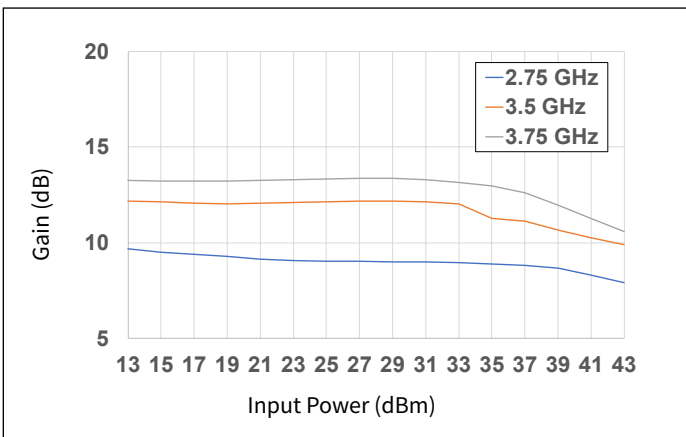

Figure 42. Large Signal Gain vs Input Power as a Function of Frequency

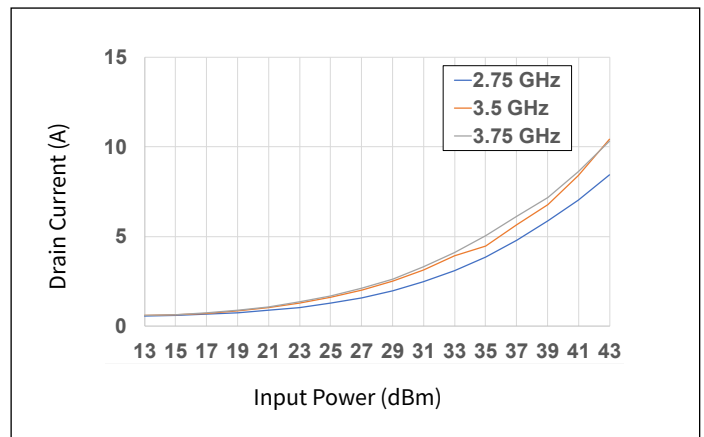

Figure 43. Drain Current vs Input Power as a Function of Frequency

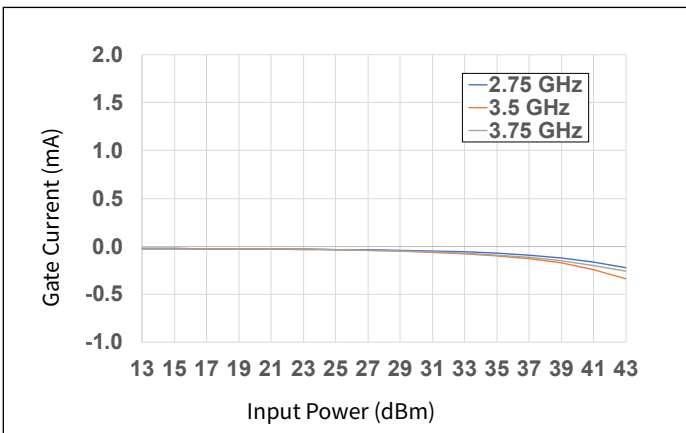

Figure 44. Gate Current vs Input Power as a Function of Frequency



Typical Performance of the CGHV38375F

Test conditions unless otherwise noted: $V_D = 50\text{ V}$, $I_{DQ} = 500\text{ mA}$, CW, $P_{IN} = 43\text{ dBm}$, $T_{BASE} = +25^\circ\text{C}$

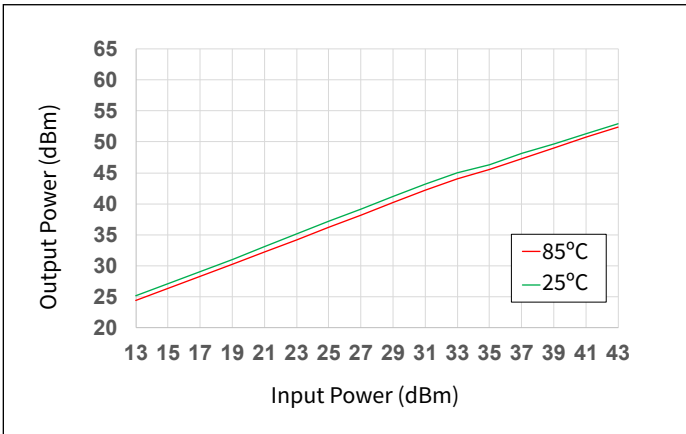

Figure 45. Output Power vs Input Power as a Function of Temperature

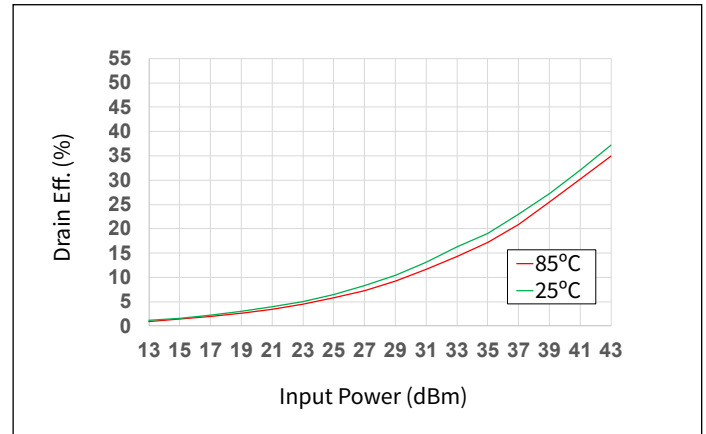

Figure 46. Drain Eff. vs Input Power as a Function of Frequency

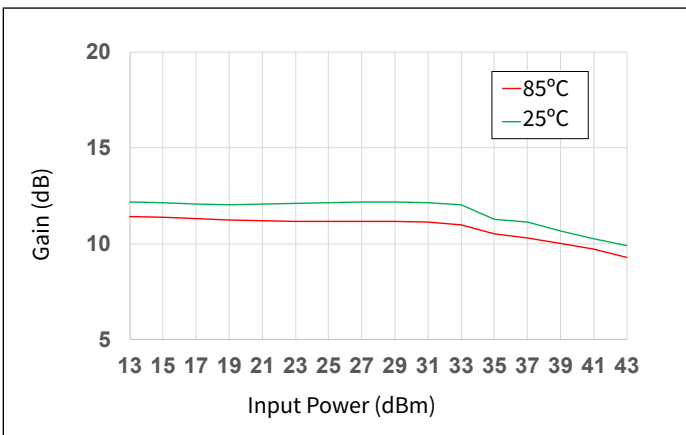

Figure 47. Large Signal Gain vs Input Power as a Function of Temperature

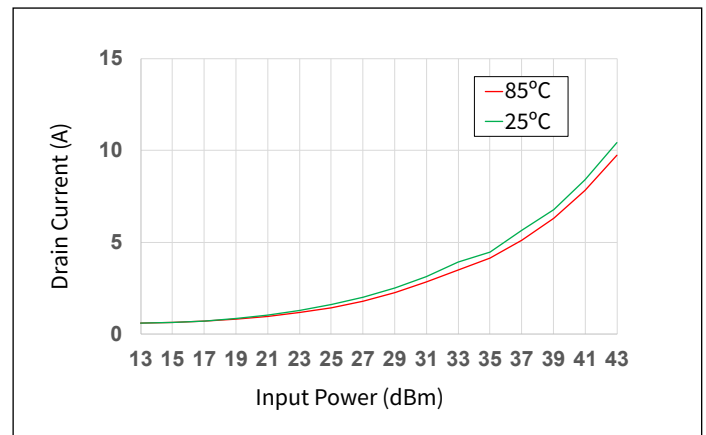

Figure 48. Drain Current vs Input Power as a Function of Temperature

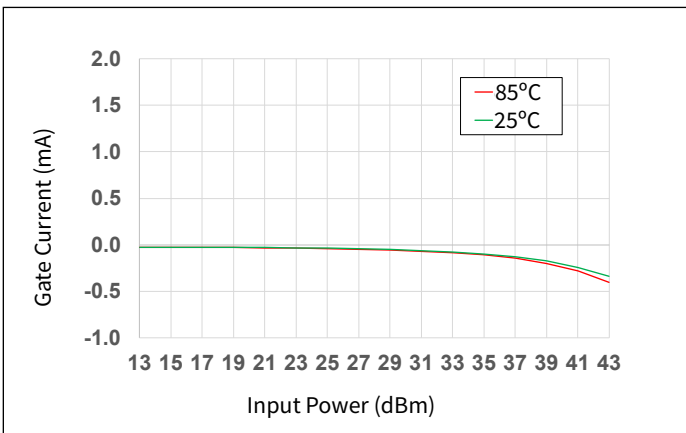

Figure 49. Gate Current vs Input Power as a Function of Temperature



Typical Performance of the CGHV38375F

Test conditions unless otherwise noted: $V_D = 50\text{ V}$, $I_{DQ} = 500\text{ mA}$, CW, $P_{IN} = 43\text{ dBm}$, $T_{BASE} = +25^\circ\text{C}$

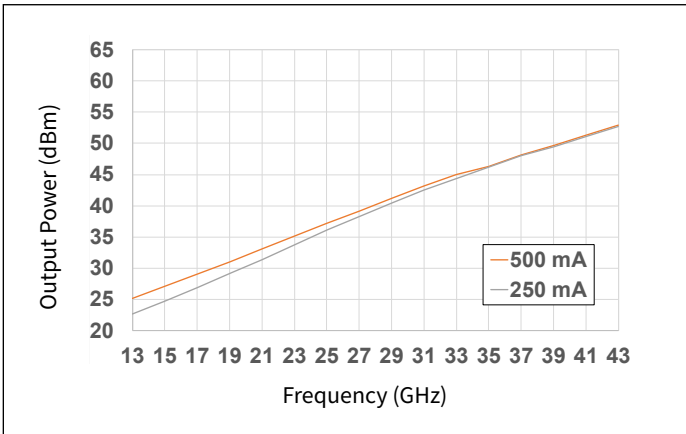

Figure 50. Output Power vs Input Power as a Function of I_{DQ}

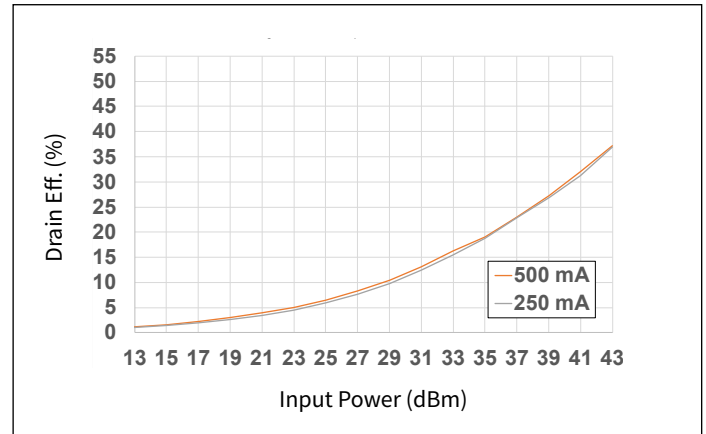

Figure 51. Drain Eff. vs Input Power as a Function of I_{DQ}

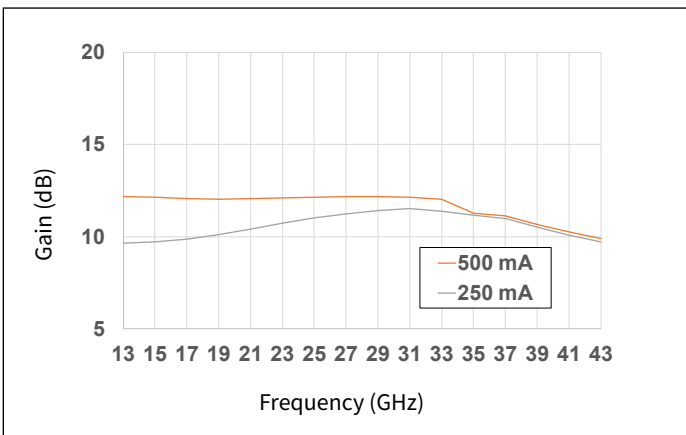

Figure 52. Large Signal Gain vs Input Power as a Function of I_{DQ}

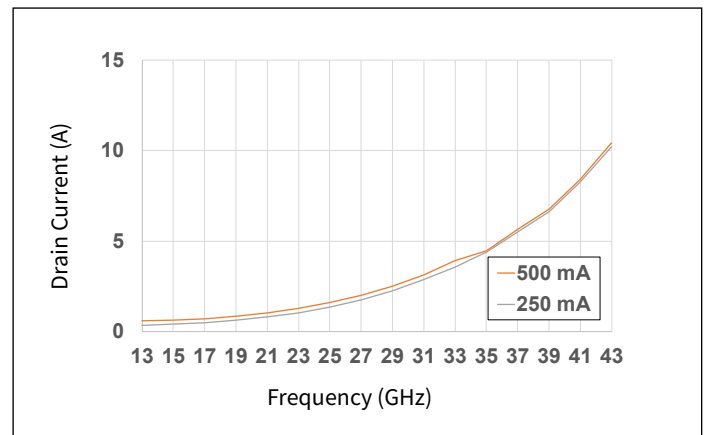

Figure 53. Drain Current vs Input Power as a Function of I_{DQ}

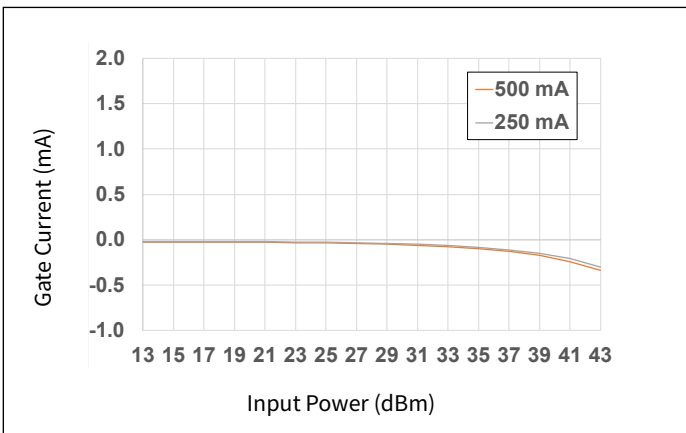

Figure 54. Gate Current vs Input Power as a Function of I_{DQ}



Typical Performance of the CGHV38375F

Test conditions unless otherwise noted: $V_D = 50\text{ V}$, $I_{DQ} = 500\text{ mA}$, Pulse Width = $100\text{ }\mu\text{s}$, Duty Cycle = 10%, $P_{IN} = 46\text{ dBm}$, $T_{BASE} = +25^\circ\text{C}$

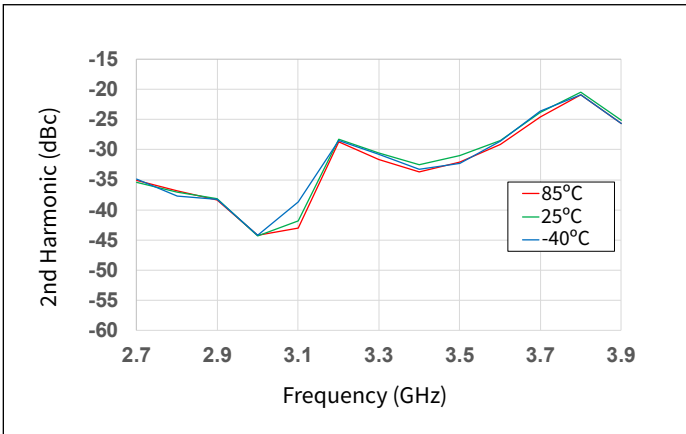

Figure 55. 2nd Harmonic vs Frequency as a Function of Temperature

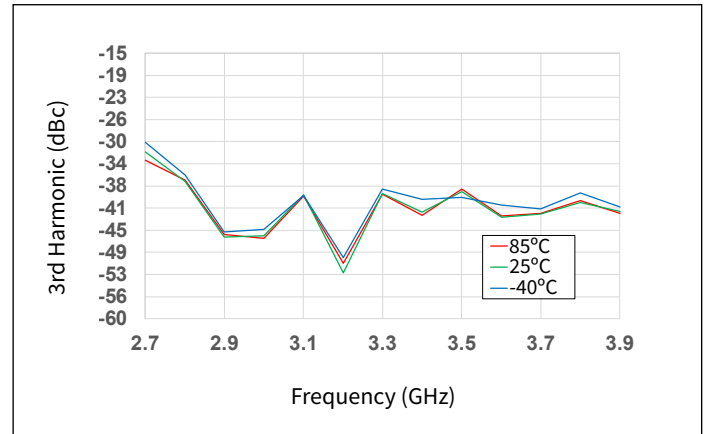

Figure 56. 3rd Harmonic vs Frequency as a Function of Temperature

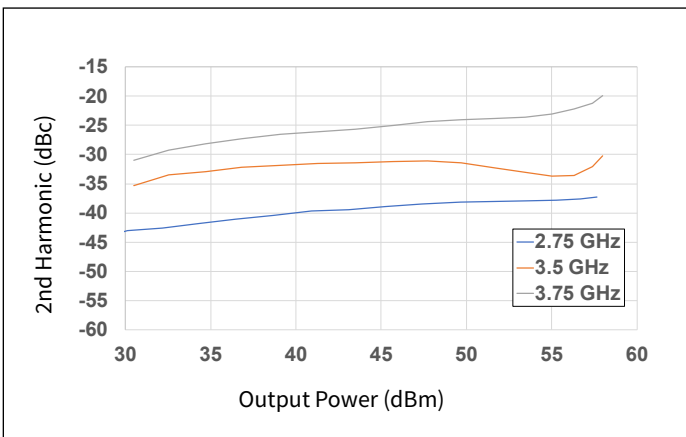

Figure 57. 2nd Harmonic vs Output Power as a Function of Frequency

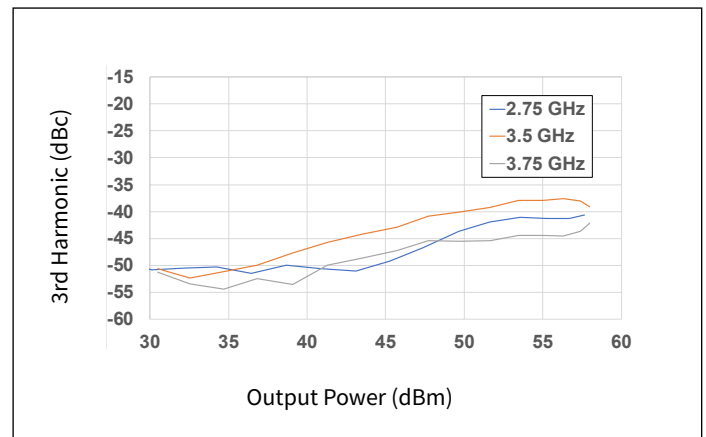

Figure 58. 3rd Harmonic vs Output Power as a Function of Frequency

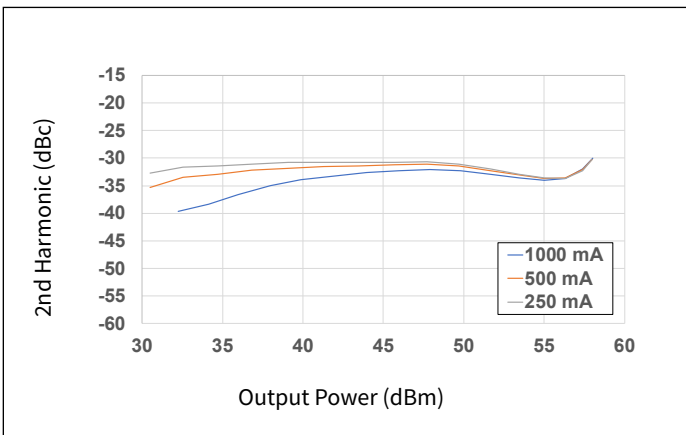

Figure 59. 2nd Harmonic vs Output Power as a Function of I_{DQ}

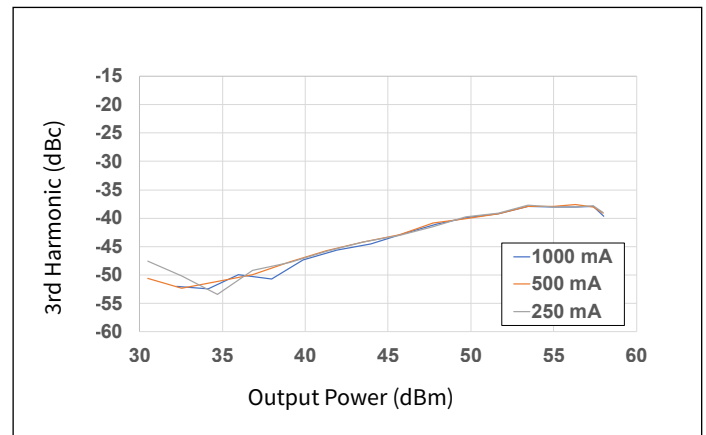

Figure 60. 3rd Harmonic vs Output Power as a Function of I_{DQ}

Typical Performance of the CGHV38375F

Test conditions unless otherwise noted: $V_D = 50\text{ V}$, $I_{DQ} = 500\text{ mA}$, $P_{IN} = -10\text{ dBm}$, $T_{BASE} = +25^\circ\text{C}$

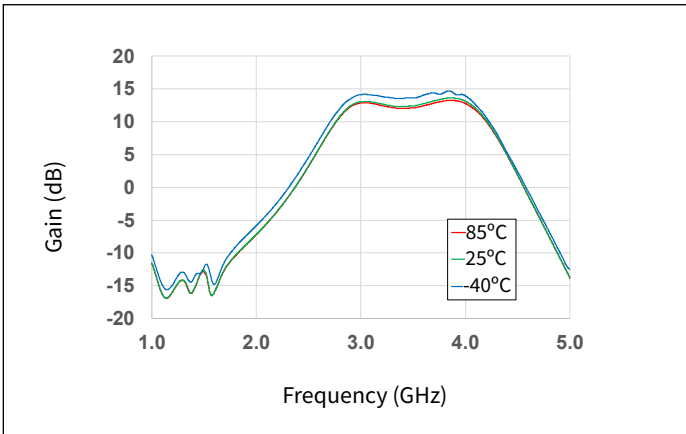

Figure 61. Gain vs Frequency as a Function of Temperature

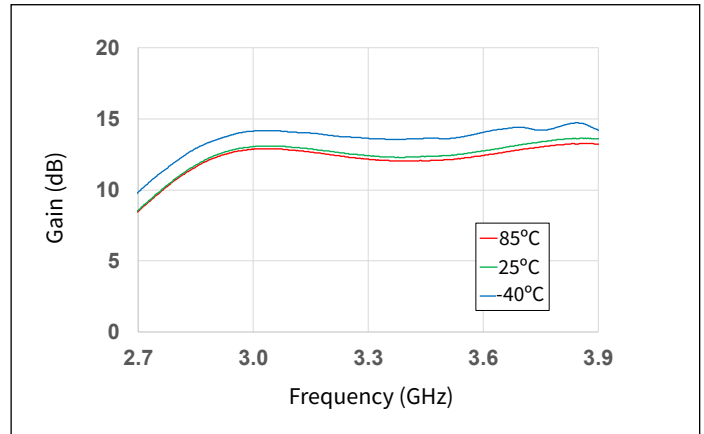

Figure 62. Gain vs Frequency as a Function of Temperature

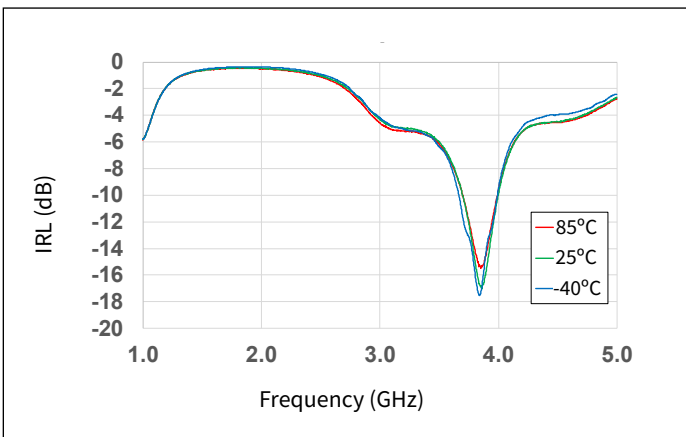

Figure 63. Input RL vs Frequency as a Function of Temperature

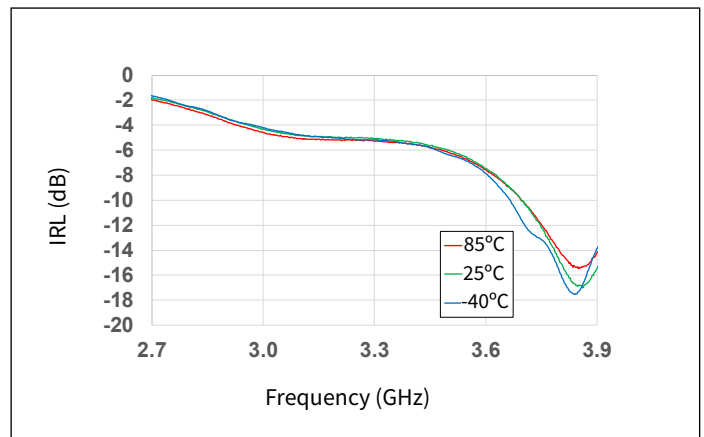

Figure 64. Input RL vs Frequency as a Function of Temperature

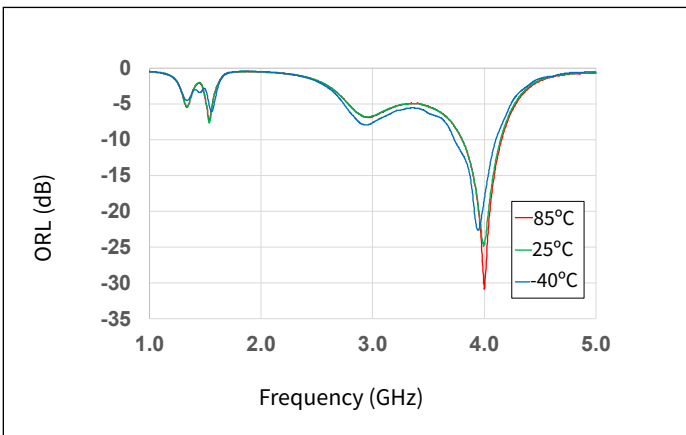

Figure 65. Output RL vs Frequency as a Function of Temperature

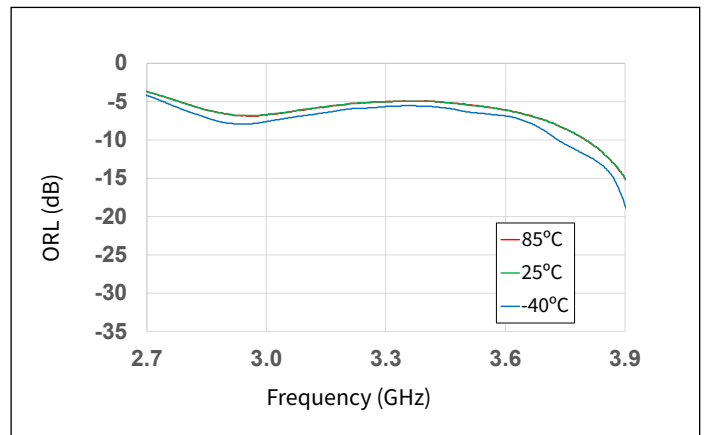

Figure 66. Output RL vs Frequency as a Function of Temperature



Typical Performance of the CGHV38375F

Test conditions unless otherwise noted: $V_D = 50\text{ V}$, $I_{DQ} = 500\text{ mA}$, $P_{IN} = -10\text{ dBm}$, $T_{BASE} = +25^\circ\text{C}$

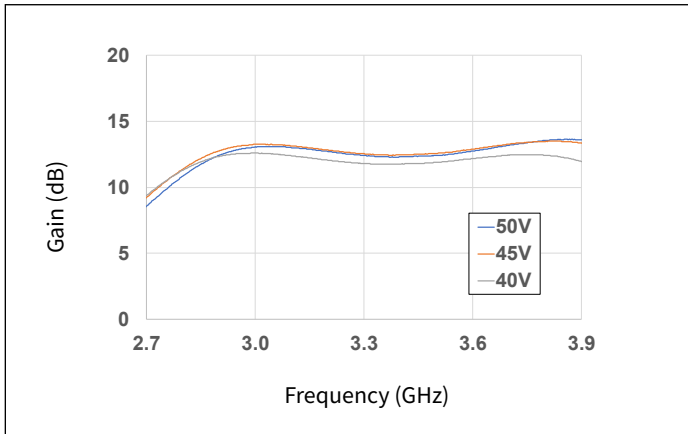

Figure 67. Gain vs Frequency as a Function of Voltage

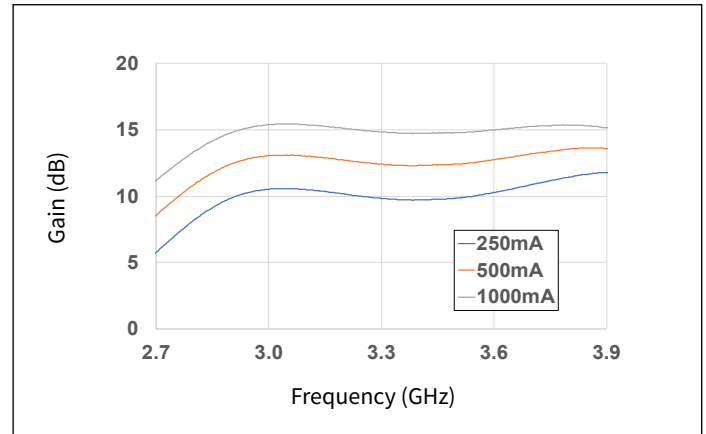

Figure 68. Gain vs Frequency as a Function of I_{DQ}

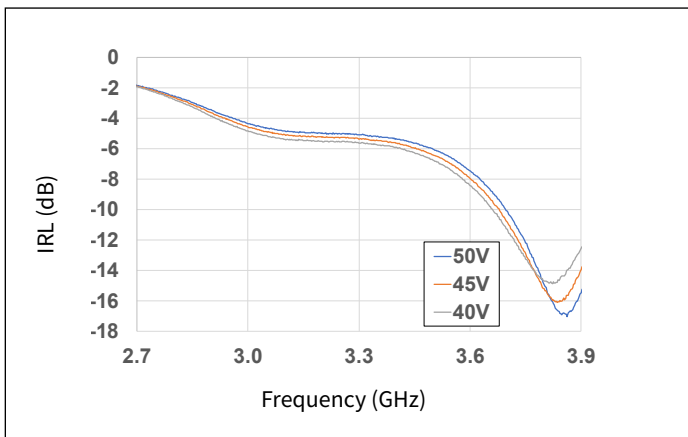

Figure 69. Input RL vs Frequency as a Function of Voltage

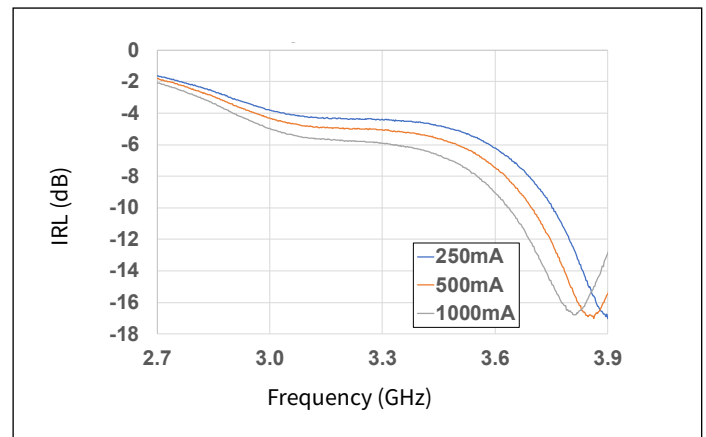

Figure 70. Input RL vs Frequency as a Function of I_{DQ}

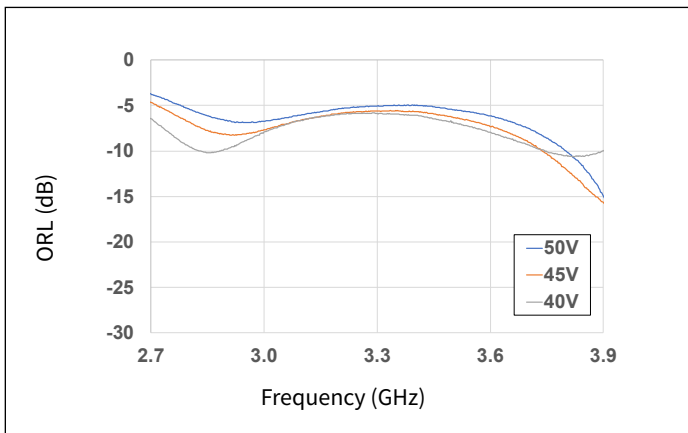

Figure 71. Output RL vs Frequency as a Function of Voltage

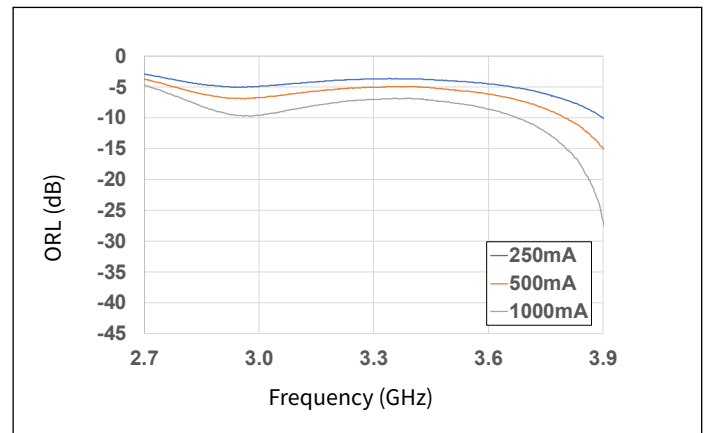
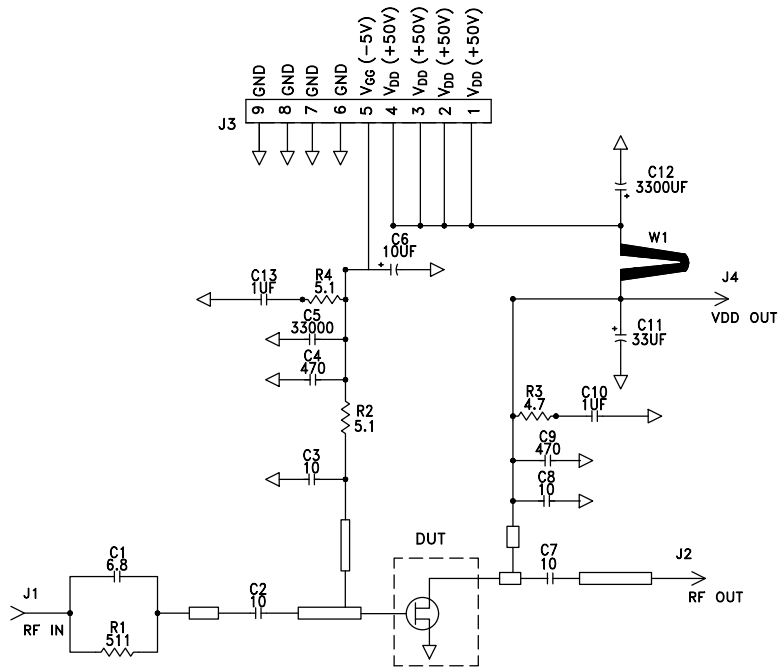

Figure 72. Output RL vs Frequency as a Function of I_{DQ}



CGHV38375F-AMP Evaluation Board Schematic



CGHV38375F-AMP Evaluation Board Outline

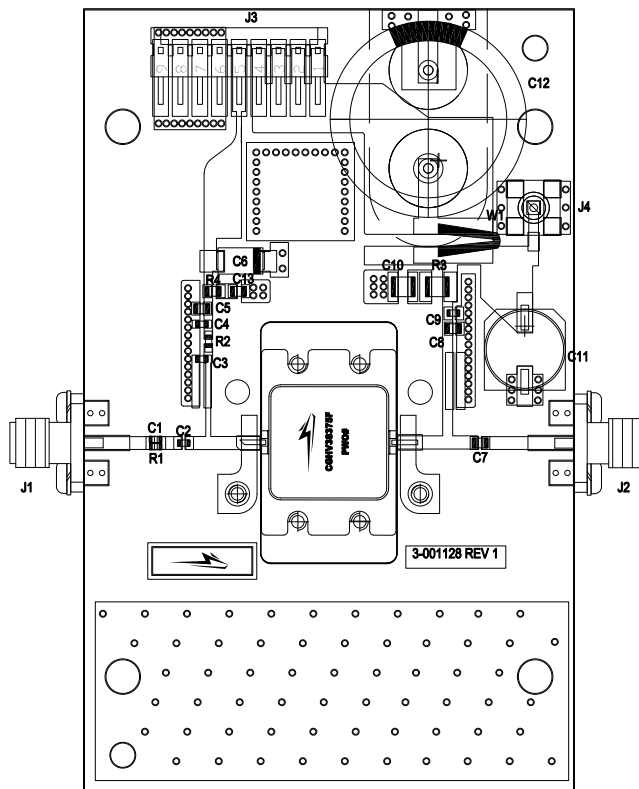



CGHV38375F-AMP Evaluation Board Bill of Materials

Designator	Description	Qty
R1	RES, 511 OHM, +/- 1%, 1/16W,0603	1
R2, R4	RES, 5.1,OHM, +/- 1%, 1/16W,0603	2
R3	RES, 4.7 OHM, 1%, 1/4W, 1206	1
C1	CAP, 6.8pF, +/- 0.25pF, 250V, 0603	1
C2,C7,C8	CAP, 10pF, +/- 1%, 250V, 0805	3
C3	CAP, 10.0pF, +/-5%,250V, 0603,	1
C4,C9	CAP, 470pF, 5%, 100V, 0603, X	2
C5	CAP, 33000pF, 0805, 100V, X7R	1
C6	CAP, 10μF, 16V, TANTALUM	1
C10	CAP, 1.0μF, 100V, 10%, X7R, 1210	1
C11	CAP, 33μF, 20%, G CASE	1
C12	CAP, 3300μF, +/-20%, 100V, ELECTROLYTIC	1
C13	CAP, 1μF, 0805, 100V, X7S	1
J1,J2	CONN, SMA, PANEL MOUNT JACK, FL	2
J3	HEADER RT>PLZ .1CEN LK 9POS	1
J4	CONNECTOR ; SMB, Straight, JACK, SMD	1
W1	CABLE, 18 AWG, 4.2	1
	PCB, RF35-TC, 2.5 X 4.0 X 0.030	1
	BASEPLATE, AL, 4.0 X 2.5 X 0.5	1
	2-56 SOC HD SCREW 1/4 SS	4
	#2 SPLIT LOCKWASHER SS	4
Q1	Transistor CGHV38375F	1

Electrostatic Discharge (ESD) Classifications

Parameter	Symbol	Class	Classification Level	Test Methodology
Human Body Model	HBM	1B	ANSI/ESDA/JEDEC JS-001 Table 3	JEDEC JESD22 A114-D
Charge Device Model	CDM	C3	ANSI/ESDA/JEDEC JS-002 Table 3	JEDEC JESD22 C101-C



Product Dimensions CGHV38375F (Package 440226)

NOTES: (UNLESS OTHERWISE SPECIFIED)

1. INTERPRET DRAWING IN ACCORDANCE WITH ANSI Y14.5M-2009
2. ADHESIVE FROM LID MAY EXTEND A MAXIMUM OF .020 BEYOND EDGE OF LID
3. LID MAY BE MISALIGNED TO THE BODY OF PACKAGE BY A MAXIMUM OF .008 IN ANY DIRECTION
4. ALL PLATED SURFACES ARE GOLD OVER NICKEL

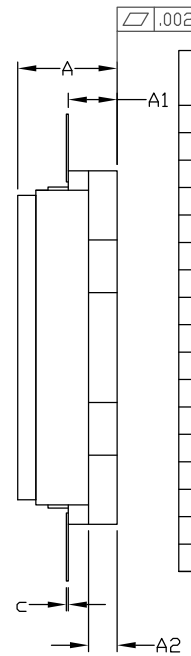
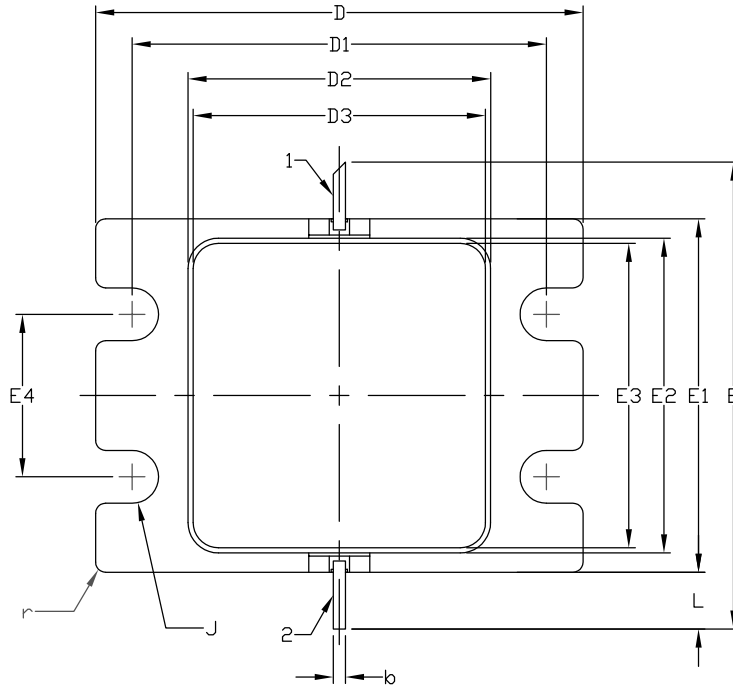

DIM	INCHES		MILLIMETERS		NOTES
	MIN	MAX	MIN	MAX	
A	0.185	0.201	4.70	5.11	
A1	0.088	0.100	2.24	2.54	2x
A2	0.049	0.061	1.24	1.55	
b	0.022	0.026	0.56	0.66	2x
c	0.003	0.006	0.08	0.15	
D	0.935	0.955	23.75	24.26	
D1	0.797	0.809	20.24	20.55	2x
D2	0.581	0.593	14.76	15.06	
D3	0.565	0.571	14.35	14.50	
E	0.906		23.01		REF
E1	0.679	0.691	17.25	17.55	
E2	0.604	0.616	15.34	15.65	
E3	0.588	0.594	14.93	15.09	
E4	0.309	0.321	7.85	8.15	2x
J	∅0.097	∅0.107	∅2.46	∅2.72	4x
L	0.090	0.130	2.29	3.30	2x
r	0.02 TYP		0.51 TYP		12x

PIN	DESC.
1	RF _{IN}
2	RF _{OUT}
3	SOURCE/FLANGE



Part Number System

CGHV38375F

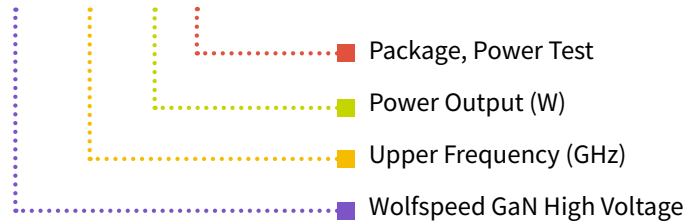

Table 1.

Parameter	Value	Units
Lower Frequency	2.75	GHz
Upper Frequency ¹	3.75	
Power Output	375	W
Package	Flange	–



Note:

¹ Alpha characters used in frequency code indicate a value greater than 9.9 GHz. See Table 2 for value.

Table 2.

Character Code	Code Value
A	0
B	1
C	2
D	3
E	4
F	5
G	6
H	7
J	8
K	9
Examples	1A = 10.0 GHz 2H = 27.0 GHz

Product Ordering Information

Order Number	Description	Unit of Measure	Image
CGHV38375F	GaN HEMT	Each	
CGHV38375F-AMP	Test board with GaN HEMT installed	Each	

**For more information, please contact:**

4600 Silicon Drive
Durham, NC 27703 USA
Tel: +1.919.313.5300
www.wolfspeed.com/RF

Sales Contact
RFSales@wolfspeed.com

RF Product Marketing Contact
RFMarketing@wolfspeed.com

Notes & Disclaimer

Specifications are subject to change without notice. “Typical” parameters are the average values expected by Wolfspeed in large quantities and are provided for information purposes only. Wolfspeed products are not warranted or authorized for use as critical components in medical, life-saving, or life-sustaining applications, or other applications where a failure would reasonably be expected to cause severe personal injury or death. No responsibility is assumed by Wolfspeed for any infringement of patents or other rights of third parties which may result from use of the information contained herein. No license is granted by implication or otherwise under any patent or patent rights of Wolfspeed.

©2021-2022 Wolfspeed, Inc. All rights reserved. Wolfspeed® and the Wolfstreak logo are registered trademarks and the Wolfspeed logo is a trademark of Wolfspeed, Inc.
PATENT: <https://www.wolfspeed.com/legal/patents>

The information in this document is subject to change without notice.