



50 MHz to 750 MHz CASCADEABLE AMPLIFIER

 Check for Samples: [THS9000](#)

FEATURES

- **High Dynamic Range**
 - $OIP_3 = 36 \text{ dBm}$
 - $NF < 4.5 \text{ dB}$
- **Single-Supply Voltage**
- **High Speed**
 - $V_S = 3 \text{ V to } 5 \text{ V}$
 - $I_S = \text{Adjustable}$
- **Input/Output Impedance**
 - 50Ω

APPLICATIONS

- **IF Amplifiers**
 - **TDMA: GSM, IS-136, EDGE/UWE-136**
 - **CDMA: IS-95, UMTS, CDMA2000**
 - **Wireless Local Loops**
 - **Wireless LAN: IEEE802.11**

DESCRIPTION

The THS9000 is a medium power, cascadeable, gain block optimized for high IF frequencies. The amplifier incorporates internal impedance matching to 50Ω . The part mounted on the standard EVM achieves greater than 15-dB input and output return loss from 50 MHz to 325 MHz with $V_S = 5 \text{ V}$, $R_{(\text{BIAS})} = 237 \Omega$, $L_{(\text{COL})} = 470 \text{ nH}$. Design requires only two dc-blocking capacitors, one power-supply bypass capacitor, one RF choke, and one bias resistor.

Figure 1. FUNCTIONAL BLOCK DIAGRAM

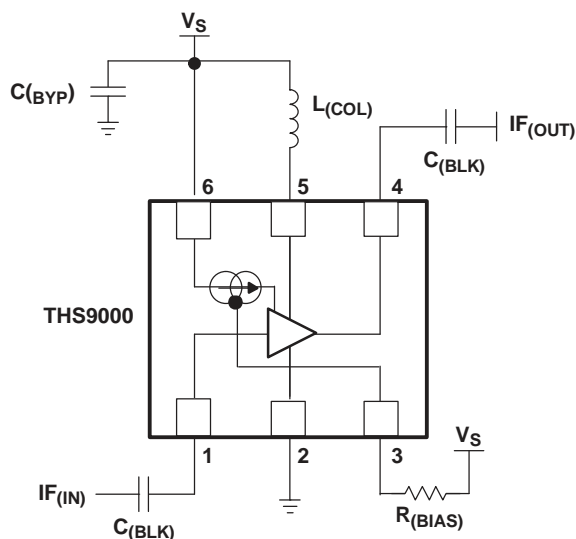

Please be aware that an important notice concerning availability, standard warranty, and use in critical applications of Texas Instruments semiconductor products and disclaimers thereto appears at the end of this data sheet.

PowerPAD is a trademark of Texas Instruments Incorporated.
All other trademarks are the property of their respective owners.



These devices have limited built-in ESD protection. The leads should be shorted together or the device placed in conductive foam during storage or handling to prevent electrostatic damage to the MOS gates.

AVAILABLE OPTIONS

PACKAGED DEVICE ⁽¹⁾	PACKAGE TYPE	TRANSPORT MEDIA, QUANTITY
THS9000DRWT	2 × 2 QFN ⁽²⁾	Tape and Reel, 250
THS9000DRWR		Tape and Reel, 3000

- (1) For the most current package and ordering information, see the Package Option Addendum at the end of this document, or see the TI Web site at www.ti.com.
 (2) The PowerPAD™ is electrically isolated from all other pins.

ABSOLUTE MAXIMUM RATINGS

Over operating free-air temperature (unless otherwise noted)⁽¹⁾

	THS9000	UNIT	
Supply voltage, GND to V _S	5.5	V	
Input voltage	GND to V _S		
Continuous power dissipation	See Dissipation Rating table		
Maximum junction temperature, T _J	+150	°C	
Maximum junction temperature, continuous operation, long term reliability, T _J ⁽²⁾	+125	°C	
Storage temperature, T _{stg}	–65 to +150	°C	
Lead temperature 1,6 mm (1/16 inch) from case for 10 seconds	+300	°C	
ESD Ratings:	HBM	2000	V
	CDM	1500	V
	MM	100	V

- (1) The absolute maximum ratings under any condition is limited by the constraints of the silicon process. Stresses above these ratings may cause permanent damage. Exposure to absolute maximum conditions for extended periods may degrade device reliability. These are stress ratings only, and functional operation of the device at these or any other conditions beyond those specified is not implied.
 (2) The maximum junction temperature for continuous operation is limited by package constraints. Operation above this temperature may result in reduced reliability and/or lifetime of the device.

DISSIPATION RATING TABLE

PACKAGE	θ_{JA} (°C/W)	POWER RATING ⁽¹⁾	
		T _A ≤ +25°C	T _A = +85°C
DRW ⁽²⁾ (3)	91	1.1 W	440 mW

- (1) Power rating is determined with a junction temperature of +125°C. Thermal management of the final PCB should strive to keep the junction temperature at or below +125°C for best performance.
 (2) This data was taken using the JEDEC standard High-K test PCB.
 (3) The THS9000 incorporates a PowerPAD on the underside of the chip. This acts as a heatsink and must be connected to a thermally dissipating plane for proper power dissipation. Failure to do so may result in exceeding the maximum junction temperature, which could permanently damage the device. See TI Technical Brief [SLMA002](#) for more information about utilizing the PowerPAD thermally-enhanced package.

RECOMMENDED OPERATING CONDITIONS

	MIN	NOM	MAX	UNIT
Supply voltage	2.7		5	V
Operating free-air temperature, T _A	–40		+85	°C
Supply current		100		mA

ELECTRICAL CHARACTERISTICS

 Typical Performance ($V_S = 5\text{ V}$, $R_{(\text{BIAS})} = 237\ \Omega$, $L_{(\text{COL})} = 470\text{ nH}$) (unless otherwise noted)

PARAMETER	TEST CONDITIONS	MIN	TYP	MAX	UNITS
Gain	$f = 50\text{ MHz}$		15.9		dB
	$f = 350\text{ MHz}$		15.6		
OIP ₃	$f = 50\text{ MHz}$		36		dBm
	$f = 350\text{ MHz}$		35		
1-dB compression	$f = 50\text{ MHz}$		20.8		dBm
	$f = 350\text{ MHz}$		20.6		
Input return loss	$f = 50\text{ MHz}$		15		dB
	$f = 350\text{ MHz}$		19.7		
Output return loss	$f = 50\text{ MHz}$		17.2		dB
	$f = 350\text{ MHz}$		15.1		
Reverse isolation	$f = 50\text{ MHz}$		21		dB
	$f = 350\text{ MHz}$		20		
Noise figure	$f = 50\text{ MHz}$		3.6		dB
	$f = 350\text{ MHz}$		4		

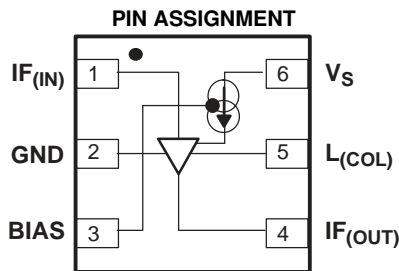

Terminal Functions

PIN NUMBERS	NAME	DESCRIPTION
1	IF _(IN)	Signal input
2	GND	Negative power-supply input
3	BIAS	Bias current adjustment input
4	IF _(OUT)	Signal output
5	L _(COL)	Output transistor load inductor
6	V _S	Positive power-supply input

SIMPLIFIED SCHEMATIC

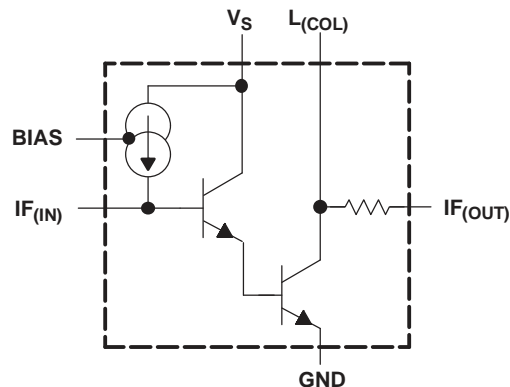

TABLE OF GRAPHS

	FIGURE
S21 Frequency response	1
S22 Frequency response	2
S11 Frequency response	3
S12 Frequency response	4
S21 vs $R_{(Bias)}$	5
Output power vs Input power	6
OIP ₂ vs Frequency	7
Noise figure vs Frequency	8
OIP ₃ vs Frequency	9
I_S Supply current vs $R_{(Bias)}$	10
S21 Frequency response	11
S22 Frequency response	12
S11 Frequency response	13
S12 Frequency response	14
Noise figure vs Frequency	15
OIP ₂ vs Frequency	16
Output power vs Input power	17
OIP ₃ vs Frequency	18

TYPICAL CHARACTERISTICS

S-Parameters of THS9000 as mounted on the EVM with $V_S = 5\text{ V}$, $R_{(BIAS)} = 237\ \Omega$, and $L_{(COL)} = 68\text{ nH}$ to 470 nH at room temperature.

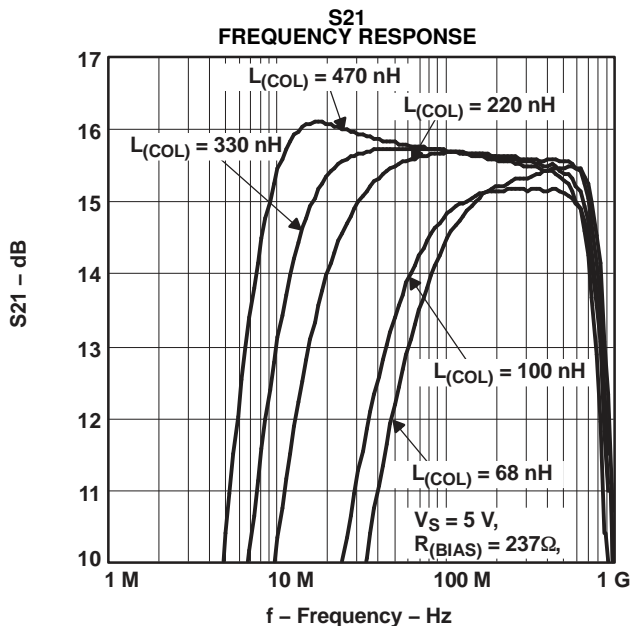

Figure 2.

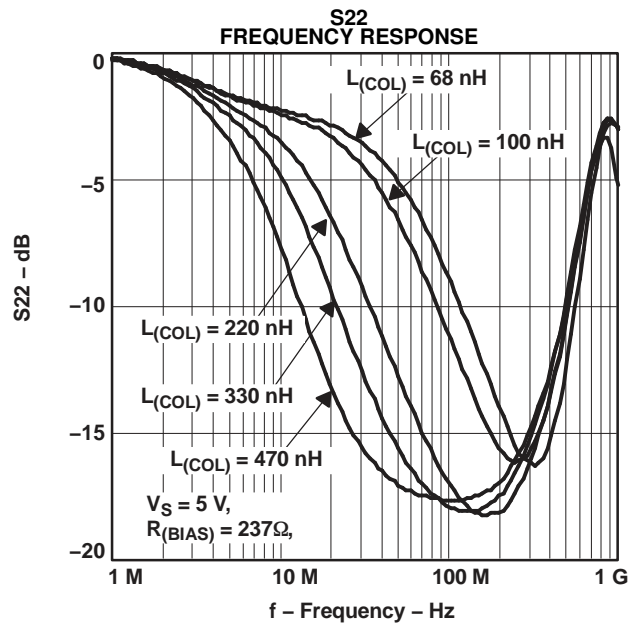

Figure 3.

TYPICAL CHARACTERISTICS (continued)

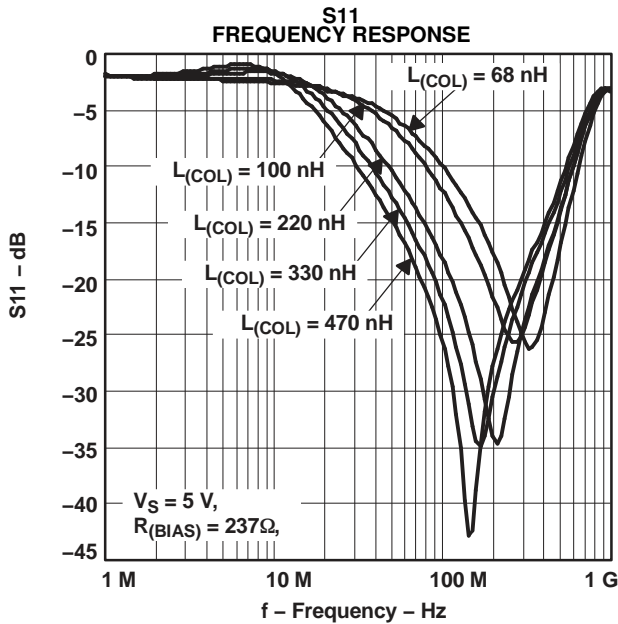

Figure 4.

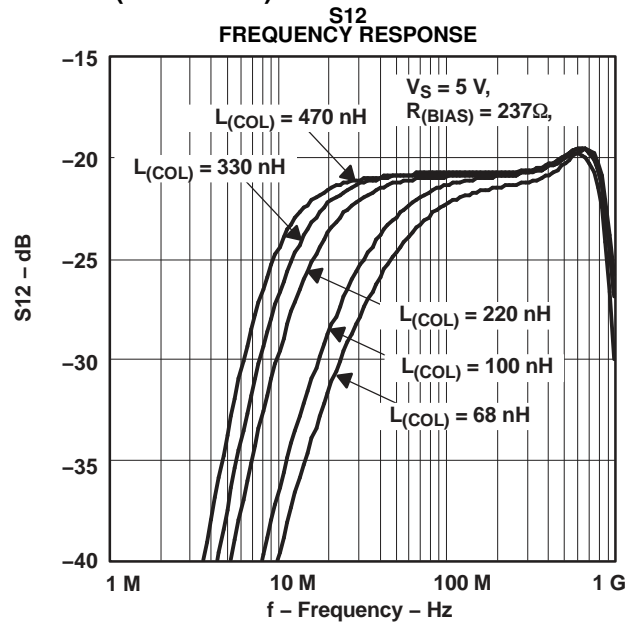

Figure 5.

S-Parameters of THS9000 as mounted on the EVM with $V_S = 3 \text{ V}$ and 5 V , $R_{(BIAS)} = \text{various}$, and $L_{(COL)} = 470 \text{ nH}$ at room temp.

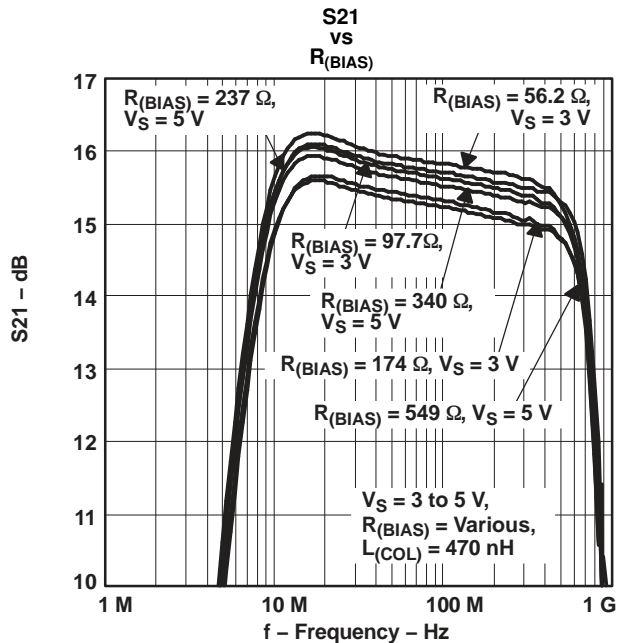

Figure 6.

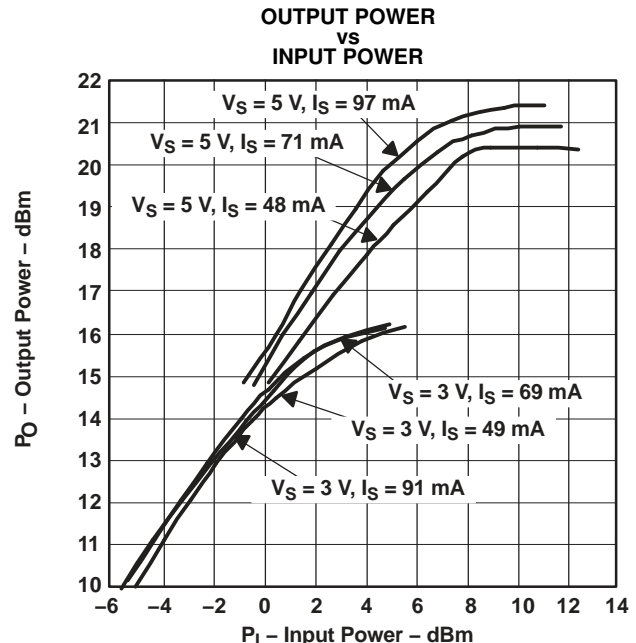

Figure 7.

TYPICAL CHARACTERISTICS (continued)

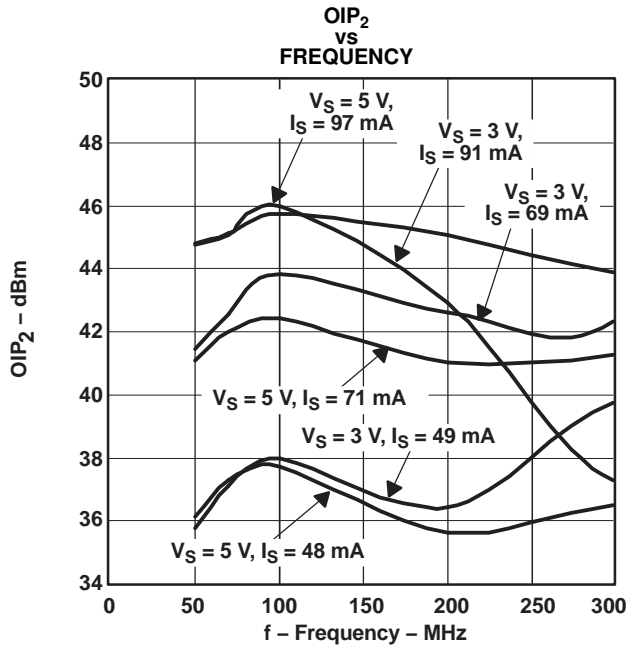

Figure 8.

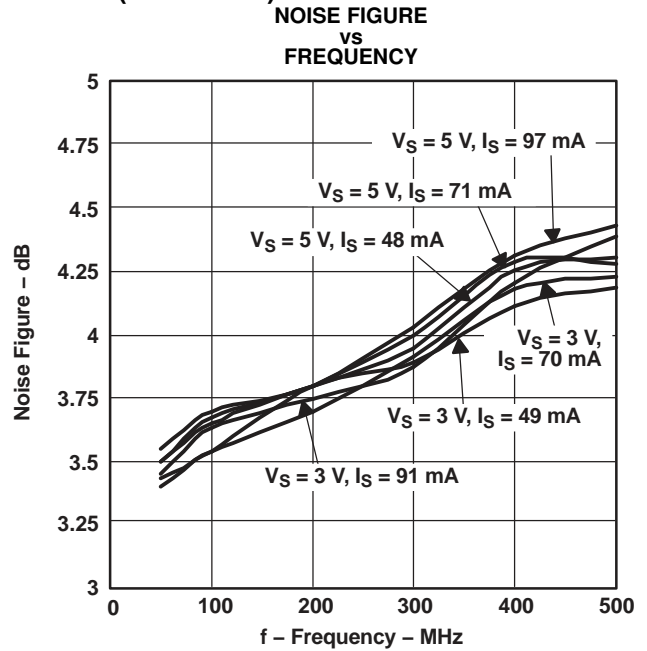

Figure 9.

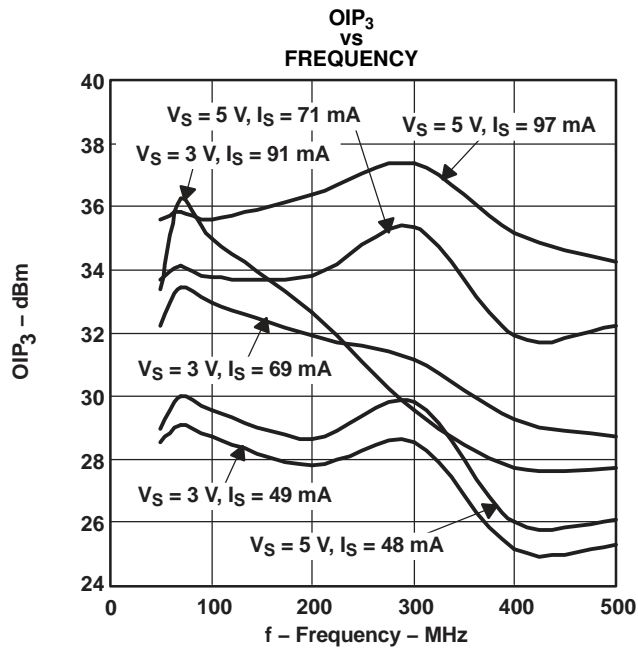

Figure 10.

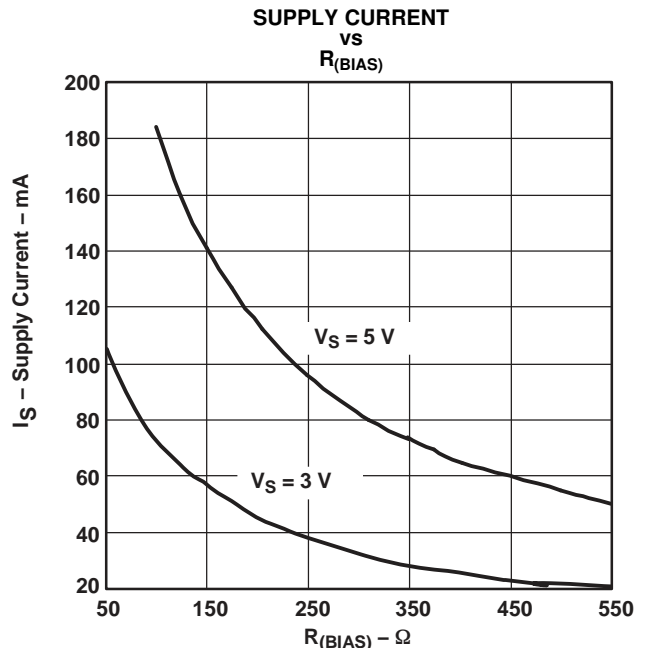

Figure 11.

TYPICAL CHARACTERISTICS (continued)

THS9000 as mounted on the EVM with $V_S = 5\text{ V}$, $R_{(BIAS)} = 237\ \Omega$, and $L_{(COL)} = 470\text{ nH}$ at $+40^\circ\text{C}$, $+25^\circ\text{C}$, and $+85^\circ\text{C}$.

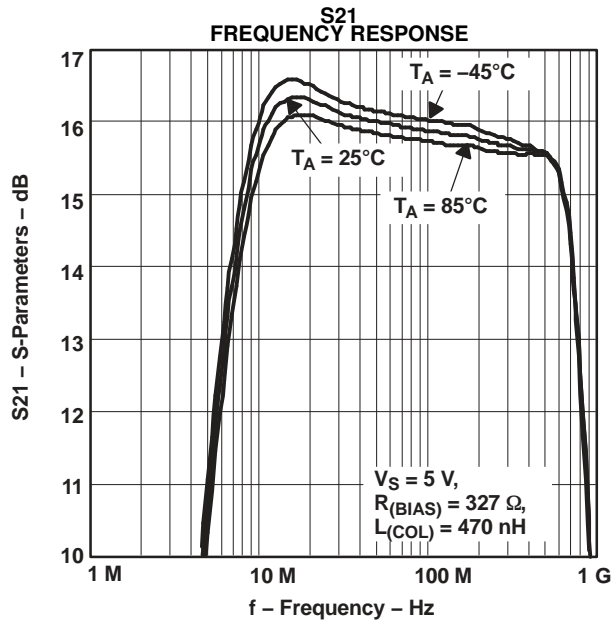

Figure 12.

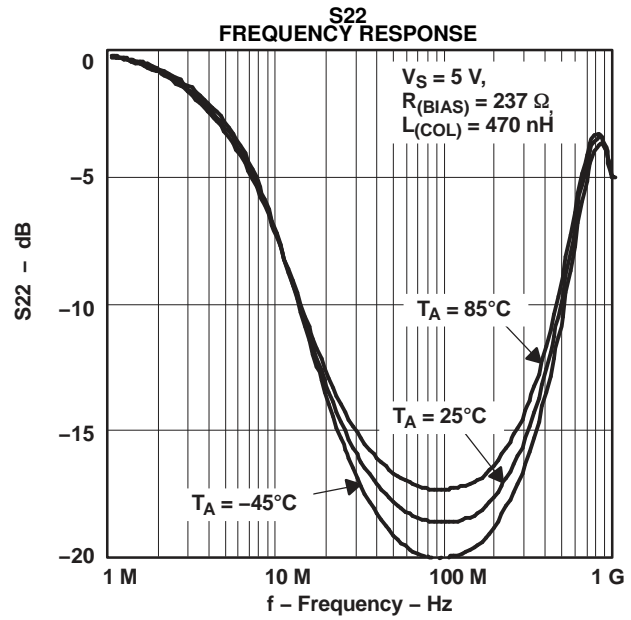

Figure 13.

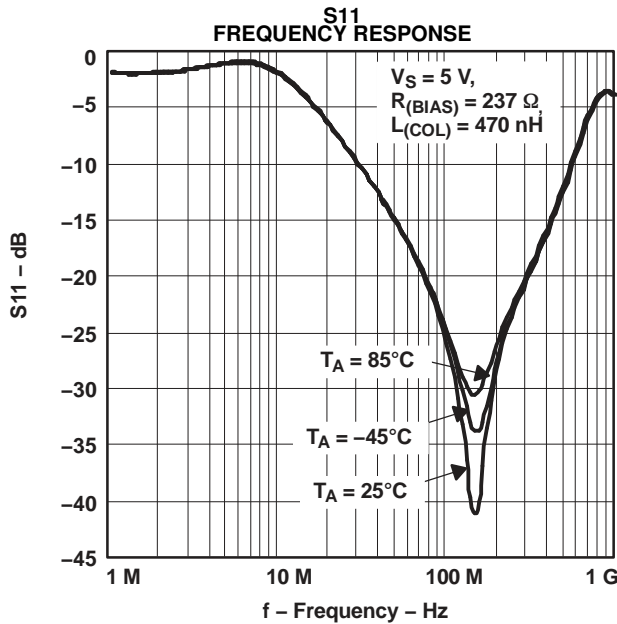

Figure 14.

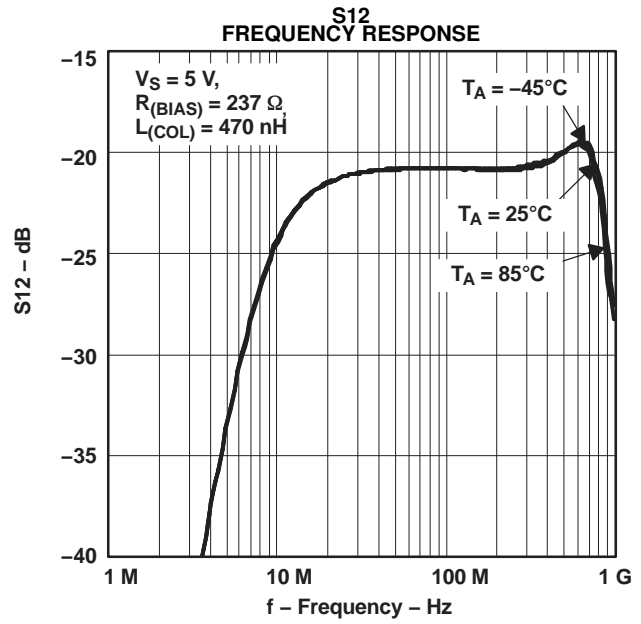

Figure 15.

TYPICAL CHARACTERISTICS (continued)

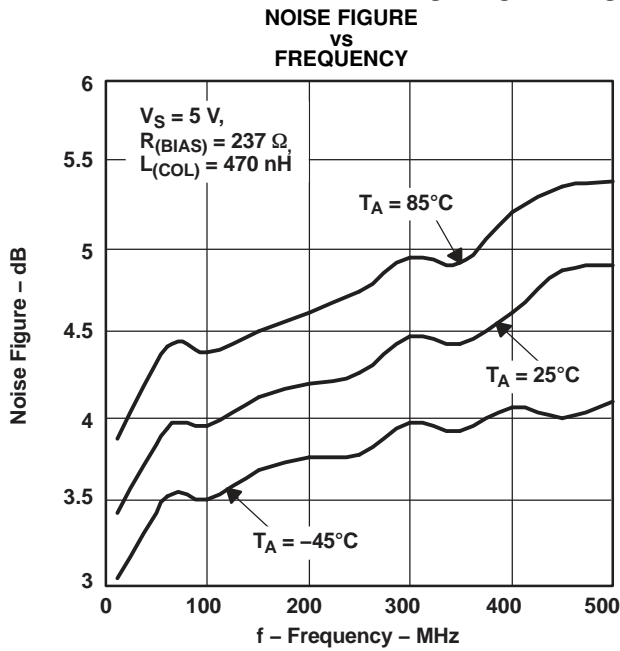

Figure 16.

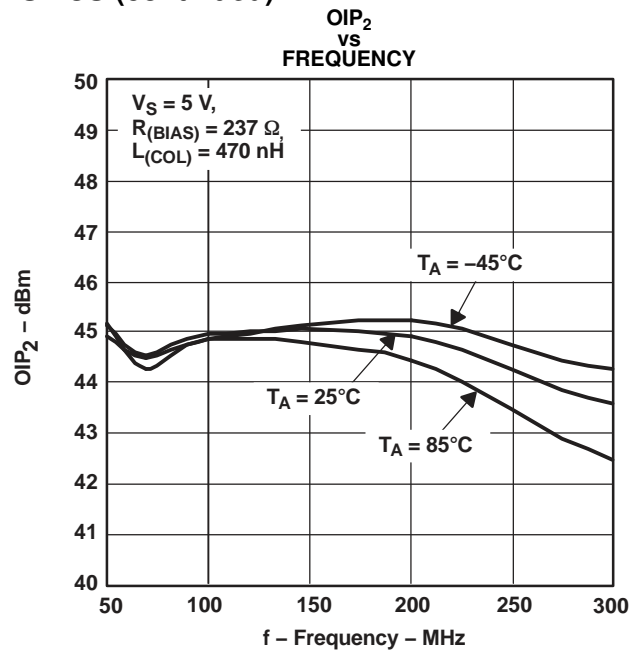

Figure 17.

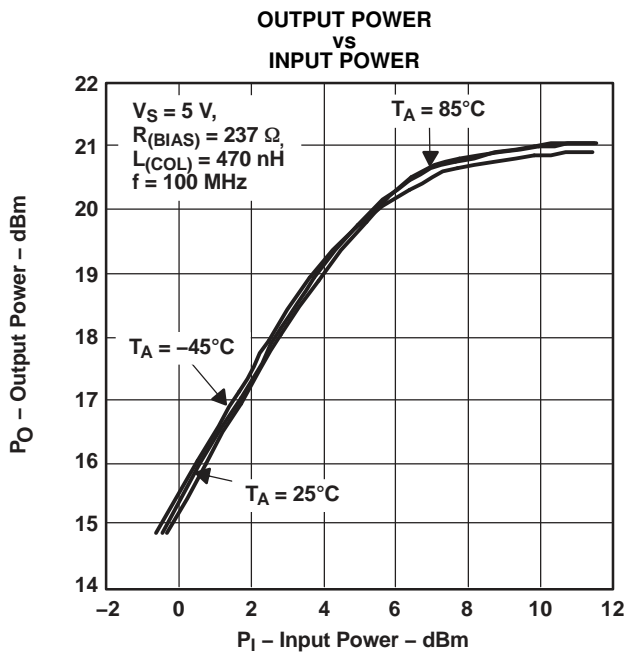

Figure 18.

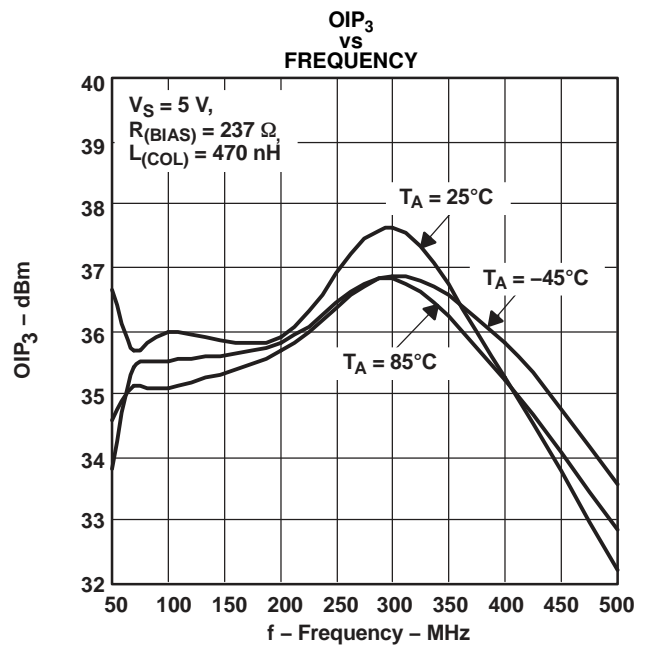

Figure 19.

TYPICAL CHARACTERISTICS

Table 1. S-Parameters Tables of THS9000 with EVM De-Embedded

$V_S = 5\text{ V}$, $R_{(\text{BIAS})} = 237\ \Omega$, $L_{(\text{COL})} = 470\ \text{nH}$								
FREQUENCY (MHz)	S21		S11		S22		S12	
	GAIN (dB)	PHASE (°)	GAIN (dB)	PHASE (°)	GAIN (dB)	PHASE (°)	GAIN (dB)	PHASE (°)
1.0	-4.2	-169.5	-2.4	-0.9	-1.9	158.1	-63.1	167.0
5.0	11.3	-124.5	-1.5	-14.5	-2.6	138.0	-32.9	122.4
10.2	15.8	-147.8	-2.2	-42.3	-5.0	101.0	-24.0	80.4
19.7	16.4	-169.4	-6.5	-69.7	-10.5	66.6	-21.3	41.6
50.1	16.0	177.2	-15.6	-91.4	-16.7	30.1	-20.7	14.4
69.7	15.9	173.5	-19.8	-97.7	-17.8	17.7	-20.7	9.1
102.4	15.9	168.4	-26.9	-102.6	-18.2	4.3	-20.7	4.4
150.5	15.8	162.0	-39.0	14.1	-18.1	-8.6	-20.7	-0.7
198.1	15.7	155.8	-27.6	50.8	-17.4	-19.6	-20.7	-1.7
246.9	15.7	149.6	-23.7	40.6	-16.4	-26.7	-20.7	-3.5
307.6	15.6	141.9	-19.8	33.1	-14.9	-37.2	-20.6	-5.7
362.8	15.6	134.7	-17.3	24.7	-13.3	-44.3	-20.4	-7.7
405.0	15.6	129.2	-15.5	20.3	-12.1	-51.0	-20.2	-10.0
452.2	15.6	122.3	-13.8	14.7	-10.6	-58.1	-19.9	-12.5
504.7	15.5	114.9	-11.8	6.3	-9.0	-66.5	-19.7	-16.2
563.4	15.4	105.8	-9.7	-2.9	-7.2	-77.5	-19.4	-22.4
595.3	15.3	100.5	-8.6	-9.1	-6.3	-83.6	-19.3	-26.2
664.5	14.9	88.7	-6.3	-24.2	-4.4	-99.7	-19.3	-36.7
702.1	14.6	81.0	-5.3	-33.2	-3.7	-109.2	-19.6	-43.4
741.8	14.1	76.3	-4.4	-42.9	-3.0	-118.8	-19.9	-50.2
828.1	12.7	60.2	-2.9	-65.5	-2.3	-142.8	-21.7	-69.2
874.9	11.2	51.0	-2.5	-77.9	-2.5	-155.0	-23.6	-75.0
924.4	10.1	50.2	-2.4	-90.4	-3.1	-166.0	-25.8	-85.2
976.7	8.8	51.8	-2.5	-100.7	-4.3	-173.7	-28.4	-78.9
1031.9	9.2	58.2	-2.6	-108.7	-4.7	-175.2	-29.7	-68.7
1090.3	8.9	48.0	-2.5	-115.2	-4.4	-164.7	-31.4	-69.1
1151.9	8.8	39.9	-2.3	-123.3	-3.5	-175.4	-33.6	-83.4
1217.1	8.0	27.7	-2.1	-132.0	-3.0	175.3	-38.2	-81.4
1285.9	7.0	30.5	-2.0	-140.7	-2.8	168.7	-42.3	-25.5
1358.6	5.6	20.6	-1.9	-149.4	-2.9	159.1	-42.2	41.6
1435.5	4.3	19.5	-1.8	-159.4	-3.0	151.3	-38.7	63.3
1516.6	3.4	17.7	-1.9	-168.3	-3.2	144.7	-33.6	62.4
1602.4	2.8	16.5	-2.0	-177.2	-3.5	138.2	-30.5	59.6
1693.0	2.2	8.6	-2.1	174.0	-3.8	131.4	-28.1	56.2
1788.8	1.4	-0.7	-2.2	165.4	-4.1	124.6	-26.2	50.4
1889.9	0.5	-4.1	-2.3	157.0	-4.5	118.2	-24.7	42.4
1996.8	-0.6	-4.5	-2.6	150.0	-4.9	111.2	-24.2	39.5

APPLICATION INFORMATION

The THS9000 is a medium power, cascadeable, amplifier optimized for high intermediate frequencies in radios. The amplifier is unconditionally stable and the design requires only two dc-blocking capacitors, one power-supply bypass capacitor, one RF choke, and one bias resistor. Refer to [Figure 26](#) for the circuit diagram.

The THS9000 operates with a power-supply voltage ranging from 2.5 V to 5.5 V.

The value of $R_{(BIAS)}$ sets the bias current to the amplifier. Refer to [Figure 11](#). This allows the designer to trade-off linearity versus power consumption. $R_{(BIAS)}$ can be removed without damage to the device.

Component selection of $C_{(BYP)}$, C_{IN} , and C_{OUT} is not critical. The values shown in [Figure 26](#) were used for all the data shown in this data sheet.

The amplifier incorporates internal impedance matching to $50\ \Omega$ that can be adjusted for various frequencies of operation by proper selection of $L_{(COL)}$.

[Figure 20](#) shows the s-parameters of the part mounted on the standard EVM with $V_S = 5\text{ V}$, $R_{(BIAS)} = 237\ \Omega$, and $L_{(COL)} = 470\text{ nH}$. With this configuration, the part is very broadband, and achieves greater than 15-dB input and output return loss from 50 MHz to 325 MHz.

[Figure 21](#) shows the S-parameters of the part mounted on the standard EVM with $V_S = 5\text{ V}$, $R_{(BIAS)} = 237\ \Omega$, and $L_{(COL)} = 68\text{ nH}$. With this configuration, the part achieves greater than 15-dB input and output return loss from 250 MHz to 400 MHz.

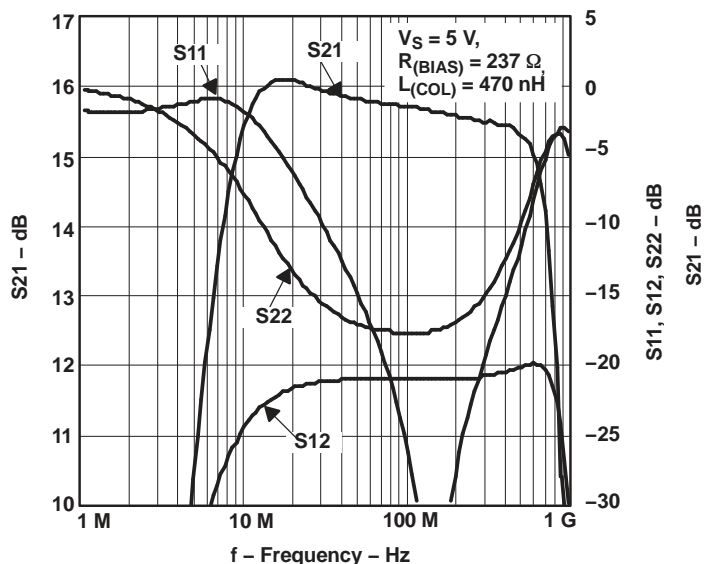

Figure 20. S-Parameters of THS9000 mounted on the standard EVM with $V_S = 5\text{ V}$, $R_{(BIAS)} = 237\ \Omega$, and $L_{(COL)} = 470\text{ nH}$

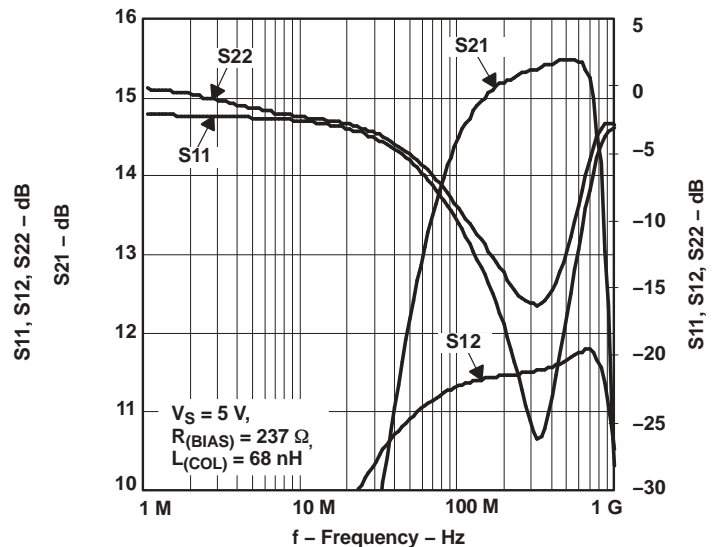

Figure 21. S-Parameters of THS9000 mounted on the standard EVM with $V_S = 5\text{ V}$, $R_{(BIAS)} = 237\ \Omega$, and $L_{(COL)} = 68\text{ nH}$

Figure 22 shows an example of a single conversion receiver architecture and where the THS9000 would typically be used.

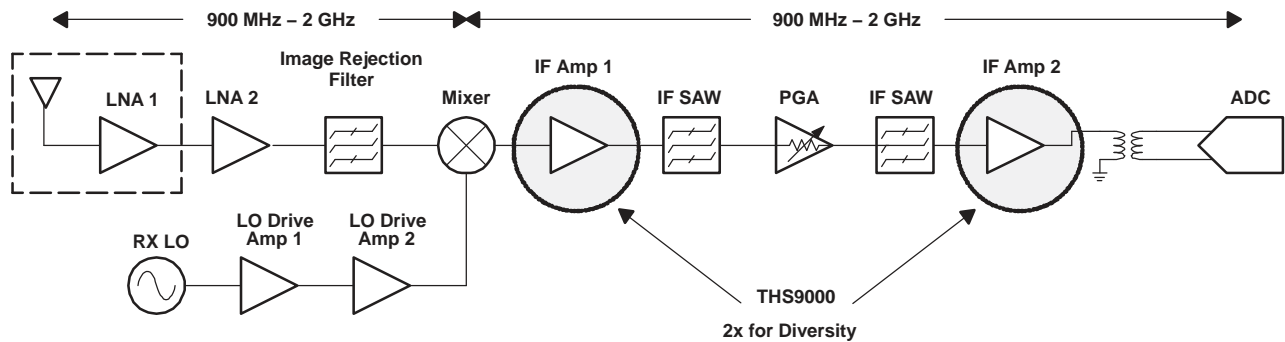

Figure 22. Example Single Conversion Receiver Architecture

Figure 23 shows an example of a dual conversion receiver architecture and where the THS9000 would typically be used.

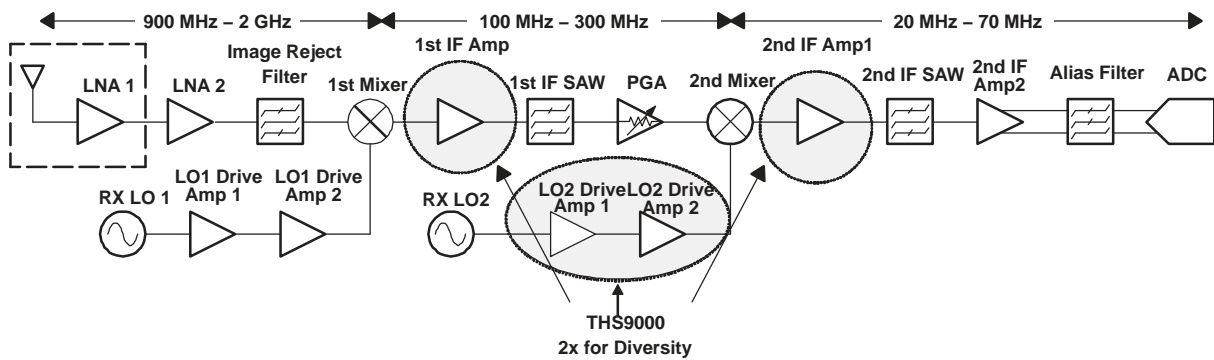

Figure 23. Example Dual Conversion Receiver Architecture

Figure 24 shows an example of a dual conversion transmitter architecture and where the THS9000 would typically be used.

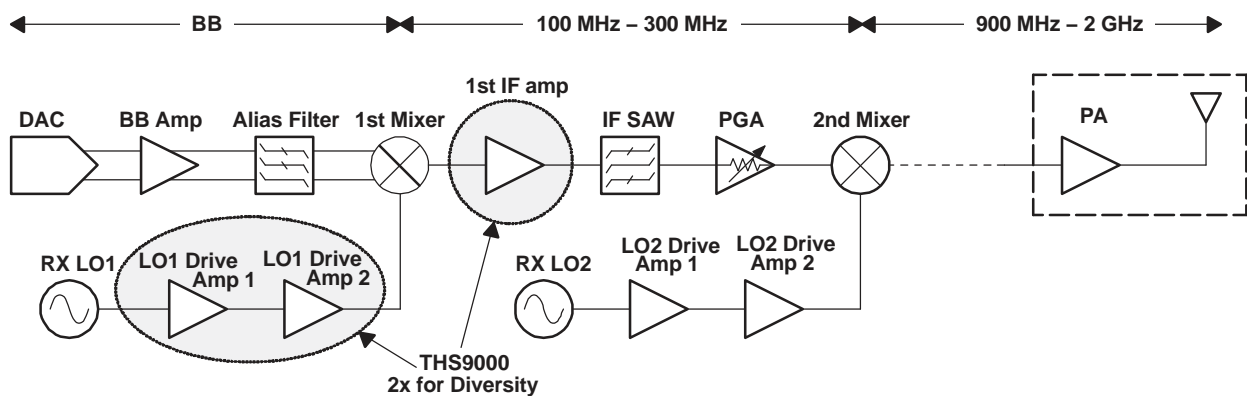
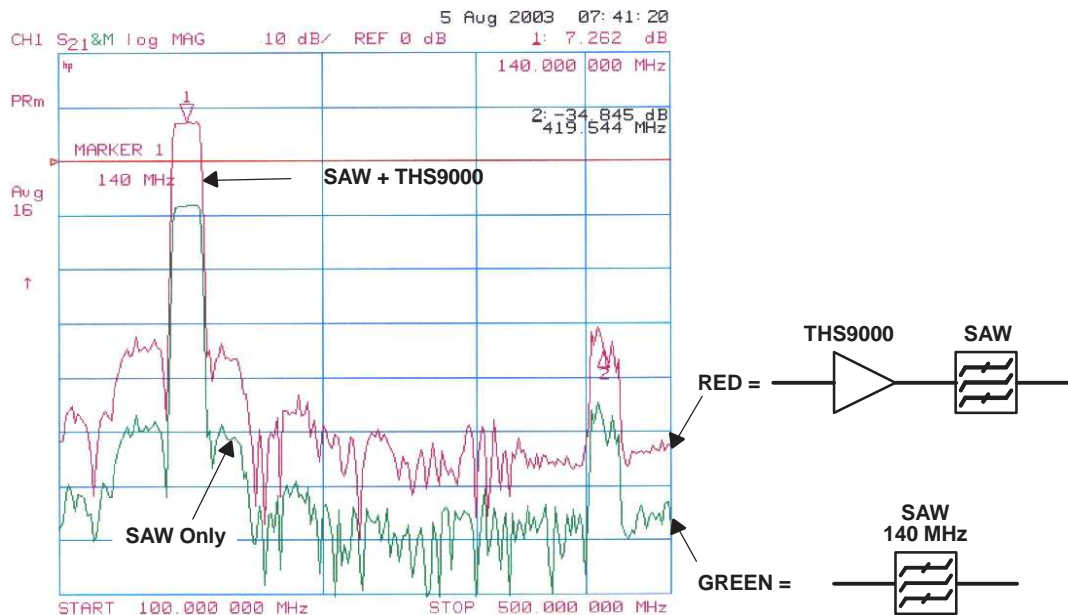

Figure 24. Example Dual Conversion Transmitter Architecture

Figure 25 shows the THS9000 and Sawtek #854916 SAW filter frequency response along with the frequency response of the SAW filter alone. The SAW filter has a center frequency of 140 MHz with 10-MHz bandwidth and 8-dB insertion loss. It can be seen that the frequency response with the THS9000 is the same as with the SAW except for a 15-dB gain. The THS9000 is mounted on the standard EVM with $V_S = 5\text{ V}$, $R_{(BIAS)} = 237\ \Omega$, and $L_{(COL)} = 470\text{ nH}$. Note the amplifier does not add artifacts to the signal.



140 MHz SAW: Sawtek #854916

Figure 25. Frequency Response of the THS9000 and SAW Filter, and SAW Filter Only

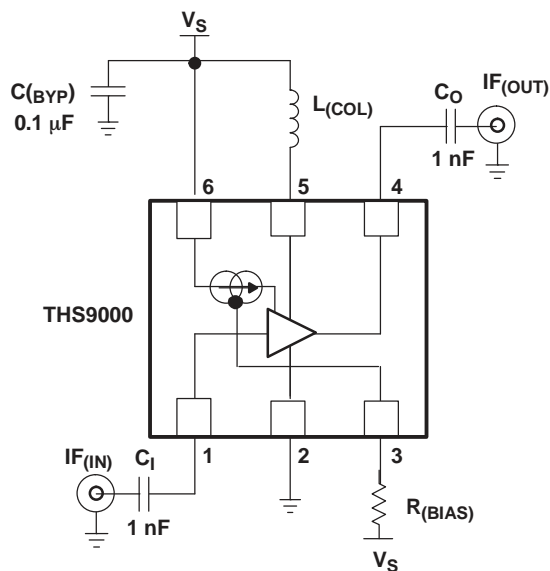

Figure 26. THS9000 Recommended Circuit (used for all tests)

Evaluation Module

Table 1 is the bill of materials, and [Figure 27](#) and [Figure 28](#) show the EVM layout.

Bill Of Materials

ITEM	DESCRIPTION	REF DES	QTY	PART NUMBER ⁽¹⁾
1	Cap, 0.1 μ F, ceramic, X7R, 50 V	C1	1	(AVX) 08055C104KAT2A
2	Cap, 1000 pF, ceramic, NPO, 100 V	C2, C3	2	(AVX) 08051A102JAT2A
3	Inductor, 470 nH, 5%	L1	1	(Coilcraft) 0805CS-471XJBC
4	Resistor, 237 Ω , 1/8 W, 1%	R1	1	(Phycomp) 9C08052A2370FKHFT
5	Open	TR1	1	
6	Jack, banana receptance, 0.25" dia.	J3, J4	2	(SPC) 813
7	Connector, edge, SMA PCB jack	J1, J2	2	(Johnson) 142-0701-801
8	Standoff, 4-40 Hex, 0.625" Length		4	(KEYSTONE) 1808
9	Screw, Phillips, 4-40, .250"		4	SHR-0440-016-SN
10	IC, THS9000	U1	1	(TI) THS9000DRD
11	Board, printed-circuit		1	(TI) EDGE # 6453521 Rev.A

(1) The manufacturer's part numbers are used for test purposes only.

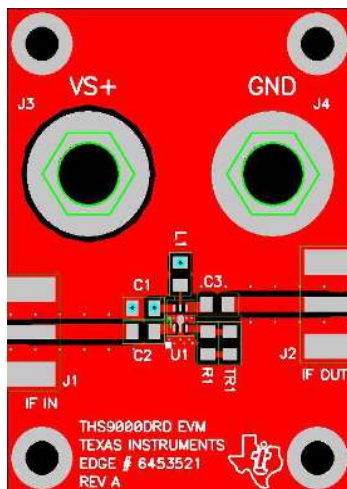

Figure 27. EVM Top Layout

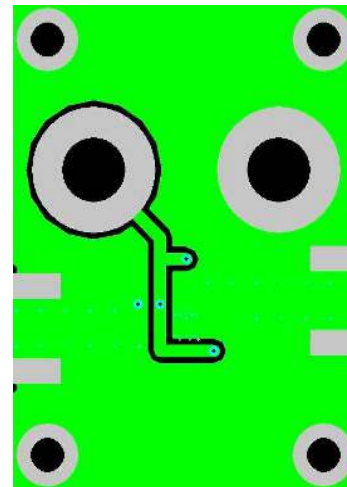

Figure 28. EVM Bottom Layout

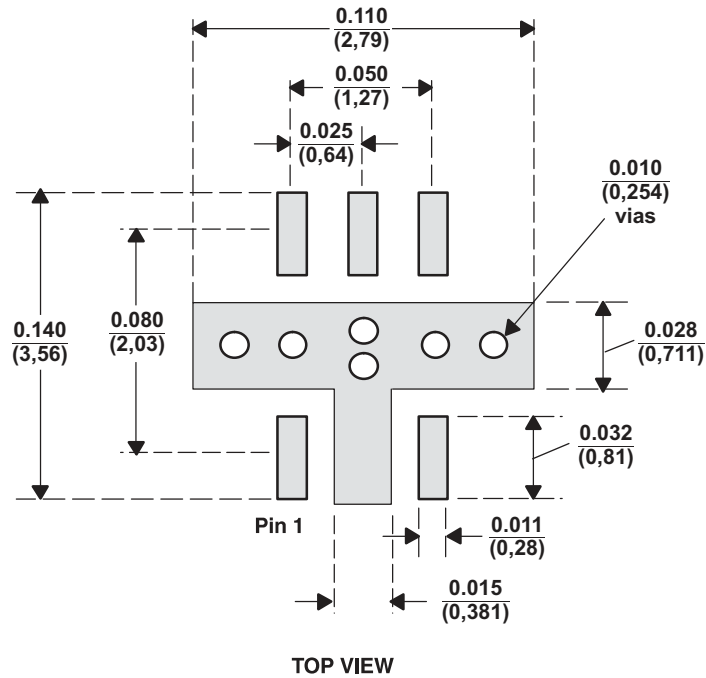

Figure 29. THS9000 Recommended Footprint dimensions are in inches (millimeters)

REVISION HISTORY

Changes from Revision D (October 2008) to Revision E	Page
---	-------------

- | | | |
|---|---|---|
| • | Changed the data sheet title From: 50 MHz to 400 MHz CASCADEABLE AMPLIFIER To: 50 MHz to 750 MHz
CASCADEABLE AMPLIFIER | 1 |
|---|---|---|
-

Changes from Revision C (February 2007) to Revision D	Page
--	-------------

- | | | |
|---|--|---|
| • | Removed the DRD ordering options from the <i>Available Options</i> table | 2 |
|---|--|---|
 - | | | |
|---|---|---|
| • | Formatted the Absolute Maximum Ratings table to current standards | 2 |
|---|---|---|
 - | | | |
|---|--|---|
| • | Deleted DRD row from the <i>Dissipation Rating</i> table | 2 |
|---|--|---|
-

PACKAGING INFORMATION

Orderable Device	Status (1)	Package Type	Package Drawing	Pins	Package Qty	Eco Plan (2)	Lead finish/ Ball material (6)	MSL Peak Temp (3)	Op Temp (°C)	Device Marking (4/5)	Samples
THS9000DRWR	ACTIVE	VSON	DRW	6	3000	RoHS & Green	NIPDAUAG	Level-2-260C-1 YEAR	-40 to 85	BQX	Samples
THS9000DRWT	ACTIVE	VSON	DRW	6	250	RoHS & Green	NIPDAUAG	Level-2-260C-1 YEAR	-40 to 85	BQX	Samples

(1) The marketing status values are defined as follows:

ACTIVE: Product device recommended for new designs.

LIFEBUY: TI has announced that the device will be discontinued, and a lifetime-buy period is in effect.

NRND: Not recommended for new designs. Device is in production to support existing customers, but TI does not recommend using this part in a new design.

PREVIEW: Device has been announced but is not in production. Samples may or may not be available.

OBsolete: TI has discontinued the production of the device.

(2) **RoHS:** TI defines "RoHS" to mean semiconductor products that are compliant with the current EU RoHS requirements for all 10 RoHS substances, including the requirement that RoHS substance do not exceed 0.1% by weight in homogeneous materials. Where designed to be soldered at high temperatures, "RoHS" products are suitable for use in specified lead-free processes. TI may reference these types of products as "Pb-Free".

RoHS Exempt: TI defines "RoHS Exempt" to mean products that contain lead but are compliant with EU RoHS pursuant to a specific EU RoHS exemption.

Green: TI defines "Green" to mean the content of Chlorine (Cl) and Bromine (Br) based flame retardants meet JS709B low halogen requirements of <=1000ppm threshold. Antimony trioxide based flame retardants must also meet the <=1000ppm threshold requirement.

(3) MSL, Peak Temp. - The Moisture Sensitivity Level rating according to the JEDEC industry standard classifications, and peak solder temperature.

(4) There may be additional marking, which relates to the logo, the lot trace code information, or the environmental category on the device.

(5) Multiple Device Markings will be inside parentheses. Only one Device Marking contained in parentheses and separated by a "~" will appear on a device. If a line is indented then it is a continuation of the previous line and the two combined represent the entire Device Marking for that device.

(6) Lead finish/Ball material - Orderable Devices may have multiple material finish options. Finish options are separated by a vertical ruled line. Lead finish/Ball material values may wrap to two lines if the finish value exceeds the maximum column width.

Important Information and Disclaimer:The information provided on this page represents TI's knowledge and belief as of the date that it is provided. TI bases its knowledge and belief on information provided by third parties, and makes no representation or warranty as to the accuracy of such information. Efforts are underway to better integrate information from third parties. TI has taken and continues to take reasonable steps to provide representative and accurate information but may not have conducted destructive testing or chemical analysis on incoming materials and chemicals. TI and TI suppliers consider certain information to be proprietary, and thus CAS numbers and other limited information may not be available for release.

In no event shall TI's liability arising out of such information exceed the total purchase price of the TI part(s) at issue in this document sold by TI to Customer on an annual basis.

TAPE AND REEL INFORMATION

QUADRANT ASSIGNMENTS FOR PIN 1 ORIENTATION IN TAPE

*All dimensions are nominal

Device	Package Type	Package Drawing	Pins	SPQ	Reel Diameter (mm)	Reel Width W1 (mm)	A0 (mm)	B0 (mm)	K0 (mm)	P1 (mm)	W (mm)	Pin1 Quadrant
THS9000DRWR	VSON	DRW	6	3000	179.0	8.4	2.2	2.2	1.2	4.0	8.0	Q2
THS9000DRWT	VSON	DRW	6	250	179.0	8.4	2.2	2.2	1.2	4.0	8.0	Q2

TAPE AND REEL BOX DIMENSIONS

*All dimensions are nominal

Device	Package Type	Package Drawing	Pins	SPQ	Length (mm)	Width (mm)	Height (mm)
THS9000DRWR	VSON	DRW	6	3000	213.0	191.0	35.0
THS9000DRWT	VSON	DRW	6	250	213.0	191.0	35.0

DRW (S-PVSON-N6)

PLASTIC SMALL OUTLINE NO-LEAD

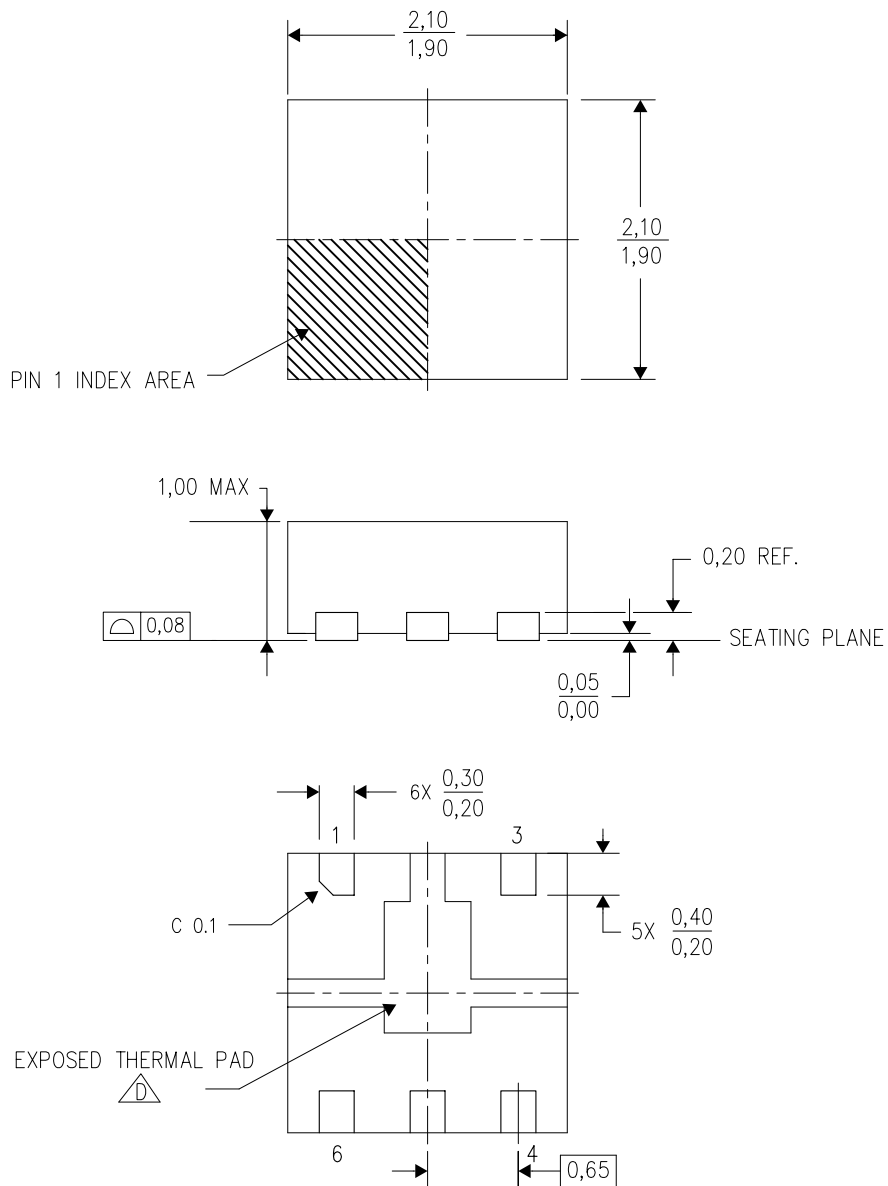

4207179/D 12/10

- NOTES:
- A. All linear dimensions are in millimeters. Dimensioning and tolerancing per ASME Y14.5-1994.
 - B. This drawing is subject to change without notice.
 - C. Small Outline No-Lead (SON) package configuration.
 -  The package thermal pad must be soldered to the board for thermal and mechanical performance. See the Product Data Sheet for details regarding the exposed thermal pad dimensions.

IMPORTANT NOTICE AND DISCLAIMER

TI PROVIDES TECHNICAL AND RELIABILITY DATA (INCLUDING DATASHEETS), DESIGN RESOURCES (INCLUDING REFERENCE DESIGNS), APPLICATION OR OTHER DESIGN ADVICE, WEB TOOLS, SAFETY INFORMATION, AND OTHER RESOURCES "AS IS" AND WITH ALL FAULTS, AND DISCLAIMS ALL WARRANTIES, EXPRESS AND IMPLIED, INCLUDING WITHOUT LIMITATION ANY IMPLIED WARRANTIES OF MERCHANTABILITY, FITNESS FOR A PARTICULAR PURPOSE OR NON-INFRINGEMENT OF THIRD PARTY INTELLECTUAL PROPERTY RIGHTS.

These resources are intended for skilled developers designing with TI products. You are solely responsible for (1) selecting the appropriate TI products for your application, (2) designing, validating and testing your application, and (3) ensuring your application meets applicable standards, and any other safety, security, or other requirements. These resources are subject to change without notice. TI grants you permission to use these resources only for development of an application that uses the TI products described in the resource. Other reproduction and display of these resources is prohibited. No license is granted to any other TI intellectual property right or to any third party intellectual property right. TI disclaims responsibility for, and you will fully indemnify TI and its representatives against, any claims, damages, costs, losses, and liabilities arising out of your use of these resources.

TI's products are provided subject to TI's Terms of Sale (<https://www.ti.com/legal/termsofsale.html>) or other applicable terms available either on [ti.com](https://www.ti.com) or provided in conjunction with such TI products. TI's provision of these resources does not expand or otherwise alter TI's applicable warranties or warranty disclaimers for TI products.

Mailing Address: Texas Instruments, Post Office Box 655303, Dallas, Texas 75265
Copyright © 2021, Texas Instruments Incorporated