

IEC Appliance Outlet J, Integrated Light Pipes, PCB terminals, Color Coding



Grey, Light Pipe Position C and D



Black, Light Pipe Position B and C



White, Light Pipe Position A and B

type J



70° C

See below:

Approvals and Compliances

Description

- Panel mount :
 Snap-in version front side
- IEC Outlet type J , Pin temperature -25 °C to 70 °C , Protection class I
- Ideal for smart PDU and UPS applications
- Pre-assembled light pipes
- For PCB mounting

Unique Selling Proposition

- Integrated Light Pipe for a space saving status indication
- Clear assignment of the status indication
- Optionally up to four Light Pipes
- Cord retention systems of V-Lock, P-Lock and TwyLock supported

Other versions on request

- Panel thickness 1.0, 1.2, 2.0, 2.5 und 3.0 mm
- Other Light Pipe Arrangements
- Other Light Pipe lengths: 32.7, 37.4 to 50 mm
- Samples available in grey and white

References

Alternative: version without light pipe

Weblinks

[pdf data sheet](#), [html datasheet](#), [General Product Information](#), [Approvals](#), [Distributor-Stock-Check](#), [Accessories](#), [Detailed request for product](#), [Landing Page](#), [Video](#)

The integration of light pipes in the appliance outlet provides status indication in smart PDUs. See PDU Landing Page for more information.

[Power Distribution Units](#)

Technical Data

Ratings IEC	16A / 250VAC; 50Hz
Ratings UL/CSA	20A / 250VAC; 60Hz
Dielectric Strength	> 1.5kVAC between L-N > 3kVAC between L/N-PE (1 min/50Hz)
Allowable Operation Temperature	-25 °C to 70 °C
IP-Protection	front side IP40 acc. to IEC 60529
Protection against electric shock	Suitable for appliances with protection class I acc. to IEC 61140
Terminal	For PCB mounting
Panel Thickness S	Snap-in: 1.5 mm
Light Pipe Length L	ø2 x 27.5 mm
Material: Housing	Thermoplastic, black / grey / white, UL 94V-0

Appliance inlet/-outlet	type J acc. to IEC 60320-1 and IEC 60320-3, UL 60320-1, CSA C22.2 no. 60320-1-11 (for cold conditions) pin-temperature 70 °C, 16A, Protection Class I
-------------------------	----------------------------------------------------------------------------------------------------------------------------------------------------------

Approvals and Compliances



Detailed information on product approvals, code requirements, usage instructions and detailed test conditions can be looked up in [Details about Approvals](#)

SCHURTER products are designed for use in industrial environments. They have approvals from independent testing bodies according to national and international standards. Products with specific characteristics and requirements such as required in the automotive sector according to IATF 16949, medical technology according to ISO 13485 or in the aerospace industry can be offered exclusively with customer-specific, individual agreements by SCHURTER.

Approvals



The approval mark is used by the testing authorities to certify compliance with the safety requirements placed on electronic products.

Approval Reference Type: 4797-5

Approval Logo	Certificates	Certification Body	Description
	VDE Approvals	VDE	Certificate Number: 40046643
	UL Approvals	UL	UR File Number: E103791
	CCC Approvals	CCC	CCC Certificate Number: 2018180204005525



Product standards

Product standards that are referenced

Organization	Design	Standard	Description
	Designed according to	IEC 60320-1	Appliance couplers for household and similar general purposes
	Designed according to	UL 60320-1	Standard for Attachment Plugs and Receptacles
	Designed according to	CSA C22.2 no. 60320-1-11	General Use Receptacles, Attachment Plugs, and Similar Wiring Devices







Application standards

Application standards where the product can be used

Organization	Design	Standard	Description
	Designed for applications acc.	IEC/UL 62368-1	Audio/video, information and communication technology equipment - Part 1: Safety requirements
	Designed for applications acc.	IEC 60335-1	Safety of electrical appliances for household and similar purposes. Meets the requirements for appliances in unattended use. This includes the enhanced requirements of glow wire tests acc. to IEC 60695-2-11 or -12 & -13.

Compliances

The product complies with following Guide Lines

Identification	Details	Initiator	Description
	CE declaration of conformity	SCHURTER AG	The CE marking declares that the product complies with the applicable requirements laid down in the harmonisation of Community legislation on its affixing in accordance with EU Regulation 765/2008.
	UKCA declaration of conformity	SCHURTER AG	The UKCA marking declares that the product complies with the applicable requirements laid down in the British Amendment of Regulation (EC) 765/2008.
	RoHS	SCHURTER AG	Directive RoHS 2011/65/EU, Amendment (EU) 2015/863
	China RoHS	SCHURTER AG	The law SJ / T 11363-2006 (China RoHS) has been in force since 1 March 2007. It is similar to the EU directive RoHS.
	REACH	SCHURTER AG	On 1 June 2007, Regulation (EC) No 1907/2006 on the Registration, Evaluation, Authorization and Restriction of Chemicals 1 (abbreviated as "REACH") entered into force.
		SCHURTER AG	V-Lock system are based on a matching plug-dose combination. The connector is equipped with a notch intended for use with the latching cordset. The cord latching system prevents against accidental removal of the cordset.
	White Paper Glow wire test	SCHURTER AG	Meets the requirements of IEC 60335-1 for appliances in unattended use. This includes the enhanced requirements of glow wire tests acc. to IEC 60695-2-11 or -12 & -13.

Dimensions [mm]

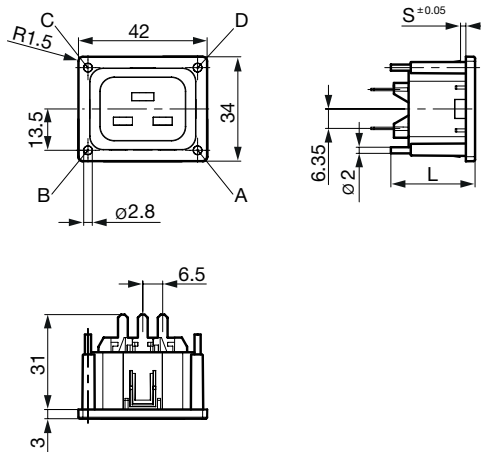

L = Light Pipe Length
 S = Panel Thickness

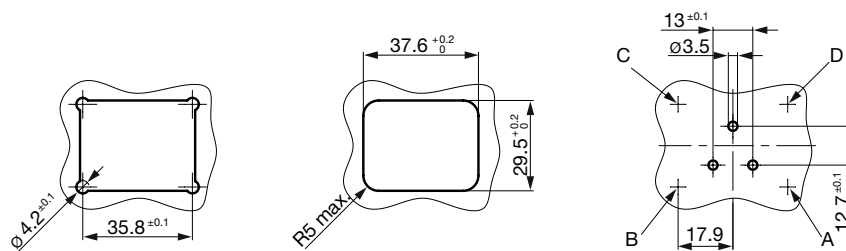

All Variants

Panel Thickness [mm]	Light Pipe Position - A	Light Pipe Position - B	Light Pipe Position - C	Light Pipe Position - D	Color	Order Number
1.5		●			black	3-103-009
1.5		●	●		black	3-103-016
1.5			●	●	black	3-104-614

Availability for all products can be searched real-time: <https://www.schurter.com/en/Stock-Check/Stock-Check-SCHURTER>

Packaging unit

50 Pcs

Mating Inlets/Plugs

Category / Description



[Plug Overview complete](#)

4796, Mounting: Power Cord, Cable, Plug: IEC I	4796
4789, Mounting: Power Cord, Screw, Plug: IEC I	4789

Mating Inlets/Plugs shuttered



[Interconnection Cord Overview complete](#)

VAC19KS, Interconnection, V-Lock cord retaining, 2.0 m, Connector IEC C19, H05VV-F3G1.5 / SJT 3x14 AWG, black	3-100-362
VAC19KS, Interconnection, V-Lock cord retaining, 3.0 m, Connector IEC C19, H05VV-F3G1.5 / SJT 3x14 AWG, black	3-100-363
VAC19KS, Interconnection, V-Lock cord retaining, 1.0 m, Connector IEC C19, H05VV-F3G1.5, black	6051.2147
VAC19KS, Interconnection, V-Lock cord retaining, 1.0 m, Connector IEC C19, H05VV-F3G1.5 / SJT 3x14 AWG, black	6051.2197