



# **PEB383 (QFP)<sup>™</sup>** **Evaluation Board User Manual**

**602060\_MA001\_01**

**February 2010**

6024 Silver Creek Valley Road, San Jose, California 95138  
Telephone: (800) 345-7015 • (408) 284-8200 • FAX: (408) 284-2775  
Printed in U.S.A.  
©2009 Integrated Device Technology, Inc.

#### GENERAL DISCLAIMER

Integrated Device Technology, Inc. reserves the right to make changes to its products or specifications at any time, without notice, in order to improve design or performance and to supply the best possible product. IDT does not assume any responsibility for use of any circuitry described other than the circuitry embodied in an IDT product. The Company makes no representations that circuitry described herein is free from patent infringement or other rights of third parties which may result from its use. No license is granted by implication or otherwise under any patent, patent rights or other rights, of Integrated Device Technology, Inc.

#### CODE DISCLAIMER

Code examples provided by IDT are for illustrative purposes only and should not be relied upon for developing applications. Any use of the code examples below is completely at your own risk. IDT MAKES NO REPRESENTATIONS OR WARRANTIES OF ANY KIND CONCERNING THE NONINFRINGEMENT, QUALITY, SAFETY OR SUITABILITY OF THE CODE, EITHER EXPRESS OR IMPLIED, INCLUDING WITHOUT LIMITATION ANY IMPLIED WARRANTIES OF MERCHANTABILITY, FITNESS FOR A PARTICULAR PURPOSE, OR NON-INFRINGEMENT. FURTHER, IDT MAKES NO REPRESENTATIONS OR WARRANTIES AS TO THE TRUTH, ACCURACY OR COMPLETENESS OF ANY STATEMENTS, INFORMATION OR MATERIALS CONCERNING CODE EXAMPLES CONTAINED IN ANY IDT PUBLICATION OR PUBLIC DISCLOSURE OR THAT IS CONTAINED ON ANY IDT INTERNET SITE. IN NO EVENT WILL IDT BE LIABLE FOR ANY DIRECT, CONSEQUENTIAL, INCIDENTAL, INDIRECT, PUNITIVE OR SPECIAL DAMAGES, HOWEVER THEY MAY ARISE, AND EVEN IF IDT HAS BEEN PREVIOUSLY ADVISED ABOUT THE POSSIBILITY OF SUCH DAMAGES. The code examples also may be subject to United States export control laws and may be subject to the export or import laws of other countries and it is your responsibility to comply with any applicable laws or regulations.

#### LIFE SUPPORT POLICY

Integrated Device Technology's products are not authorized for use as critical components in life support devices or systems unless a specific written agreement pertaining to such intended use is executed between the manufacturer and an officer of IDT.

1. Life support devices or systems are devices or systems which (a) are intended for surgical implant into the body or (b) support or sustain life and whose failure to perform, when properly used in accordance with instructions for use provided in the labeling, can be reasonably expected to result in a significant injury to the user.
2. A critical component is any components of a life support device or system whose failure to perform can be reasonably expected to cause the failure of the life support device or system, or to affect its safety or effectiveness.

IDT, the IDT logo, and Integrated Device Technology are trademarks or registered trademarks of Integrated Device Technology, Inc.

# Contents

<b>About this Document</b> .....	<b>5</b>
Related Information .....	5
Terms .....	5
Revision History .....	5
<b>1. Board Design</b> .....	<b>7</b>
1.1 Overview .....	7
1.2 PCI Interface .....	9
1.2.1 Overview .....	9
1.2.2 IDSEL Signals .....	9
1.2.3 Interrupt Signals .....	9
1.2.4 Pull-up Signals .....	9
1.3 PCIe Interface .....	10
1.4 Power Management .....	10
1.4.1 Power Regulation .....	10
1.4.2 Power Requirements .....	11
1.4.3 Power Sequencing .....	13
1.4.4 System Power Design .....	13
1.4.5 PCI Vaux (PCI Auxiliary) Support .....	14
1.5 Clock Management .....	14
1.5.1 PCI .....	14
1.5.2 System Clock Distribution .....	15
1.6 Other Interfaces .....	15
1.6.1 JTAG Interface .....	15
1.6.2 EEPROM Interface .....	15
1.6.3 GPIO Interface .....	16
1.7 Hardware Reset .....	16
1.8 Logic Analyzer Connectivity .....	17
<b>2. Configurable Options</b> .....	<b>19</b>
2.1 Switches .....	19
2.1.1 DIP Switches .....	19
2.1.2 Push Button .....	23
2.2 Shunt Jumpers .....	24
2.2.1 J6 Shunt Jumper .....	25
2.2.2 J21 Shunt Jumper .....	25
2.3 Debug Headers .....	26
2.3.1 J22 PEB383 JTAG .....	27
2.3.2 J23 Logic Analyzer PADS .....	28

2.4	Connectors .....	29
2.4.1	J1, J2, J36, J37 Connectors .....	29
2.4.2	J3 ATX Power Connector .....	30
2.4.3	P1 x1 PCIe Finger Connector .....	30
2.5	LEDs .....	31

## About this Document

This document describes how to test the key features of the PEB383 (LQFP) using the PEB383 (LQFP) evaluation board. It can be used in conjunction with the *PEB383 (LQFP) Evaluation Board Schematics*.

## Related Information

- *PEB383 User Manual*
- *PEB383 (QFP) Evaluation Board Schematics*
- *PEB383 QFP Board Design Guidelines*
- *PCI Express Base Specification (Revision 1.1)*
- *PCI Express CEM Specification (Revision 1.1)*
- *PCI Express-to-PCI/PCI-X Bridge Specification (Revision 1.0)*

## Terms

Term	Definition
PCIe	PCI Express
SerDes	Serial/De-serializer

## Revision History

### **60E2060\_MA001\_01, Formal, February, 2010**

This is the first version of the *PEB383 PCIe-to-PCI Bridge User Manual*.



---

# 1. Board Design

Topics discussed include the following:

- “Overview” on page 7
- “PCI Interface” on page 9
- “PCIe Interface” on page 10
- “Power Management” on page 10
- “Clock Management” on page 14
- “Other Interfaces” on page 15
- “Hardware Reset” on page 16
- “Logic Analyzer Connectivity” on page 17

---

## 1.1 Overview

The key features of the PEB383 evaluation board include the following (see also [Figure 1](#)):

- Single x1 lane, 2.5 Gbps PCIe 1.1 compatible riser card (extended height form factor)
- Four PCI slots
- 32-bit PCI bus, 25–66 MHz operation
- PCI power support through system or external supply
- PCIe compliance/debugging test points

Figure 1: Evaluation Board Block Diagram

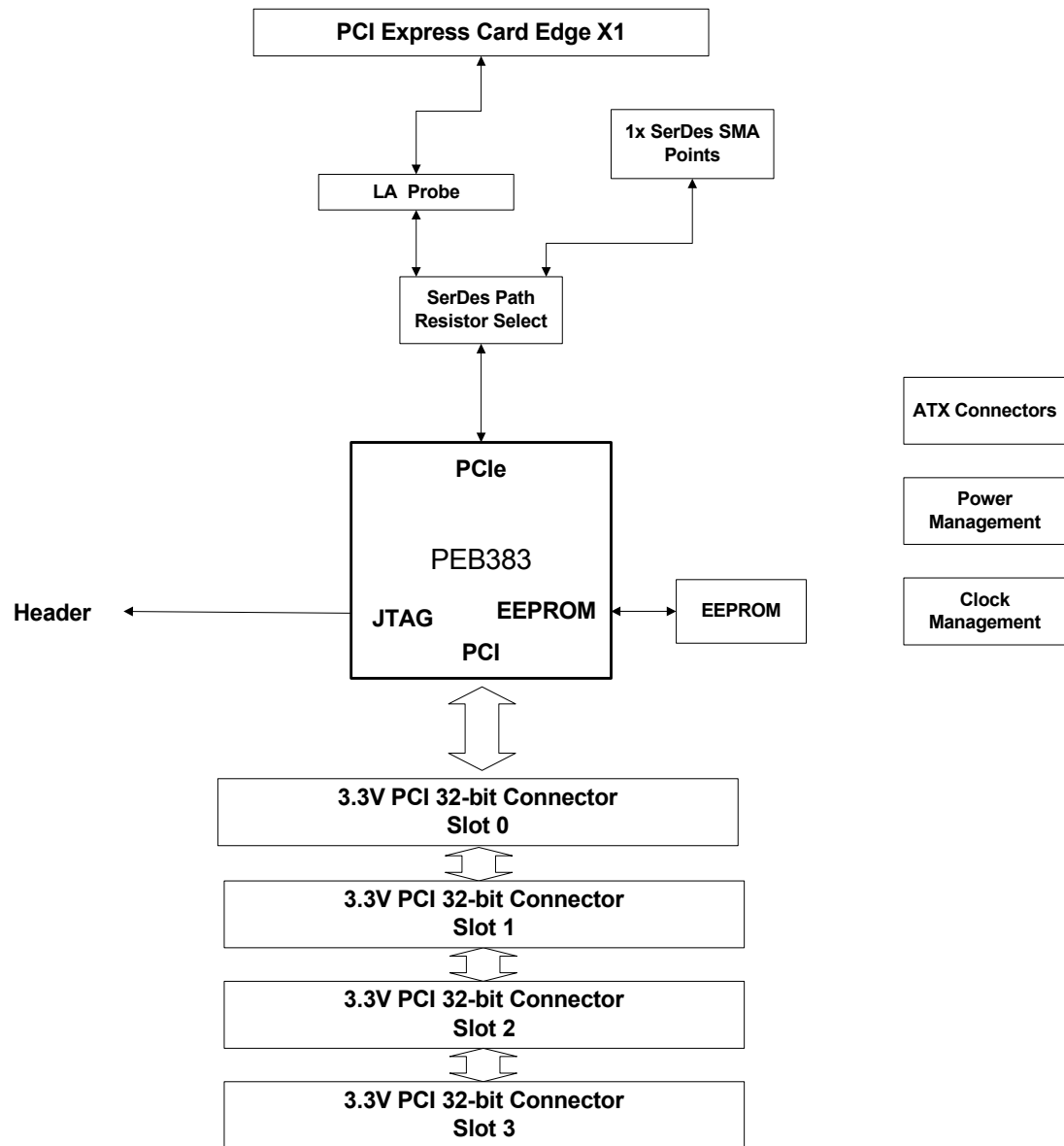



## 1.2 PCI Interface

### 1.2.1 Overview

The PCI Interface is implemented on the board with four slots, in which one is an R/A mounted connector on the top of the board. All PCI connectors are compliant with the PCI 3.0 specification. Appropriate clearance is provided such that up to four PCI cards can be inserted for testing while the board is in an open-chassis standard ATX case.

The PCI Interface supports four slots operating at 25, 33, 50, or 66 MHz.

### 1.2.2 IDSEL Signals

IDSEL signals are connected in the following order:

- Slot 0 – R/A connector top slot: 150 ohms to AD16 (Device 0)
- Slot 1 – 150 ohms to AD17 (Device 1)
- Slot 2 – 150 ohms to AD19 (Device 3)
- Slot 3 – 150 ohms AD18 (Device 2)

### 1.2.3 Interrupt Signals

The PCI interrupt signals are connected to the slots as shown in the following table.

**Table 1: PCI Interrupt Routing**

PEB383	Slot 0	Slot 1	Slot 3	Slot 4
A	A	B	D	C
B	B	C	A	D
C	C	D	B	A
D	D	A	C	B

### 1.2.4 Pull-up Signals

The following pull-ups are added to the PCI bus, in which a value of 8.2Kohm is used.

**Table 2: PCI Pull-up Signals**

Signal	Description
PCI_REQ#[0:3]	Bus request
PCI_GNT#[0:3]	Bus grant
PCI_FRAME#	Control signal
PCI_IRDY#, PCI_TRDY#	Control signal

**Table 2: PCI Pull-up Signals (Continued)**

Signal	Description
PCI_STOP#	Control signal
PCI_SERR#	System error
PCI_PERR#	Parity error
PCI_DEVSEL#	Device select line
PCI_INT#[A:D]	Interrupt line
PCI_PME#	PCI Power Management Event occurred

## 1.3 PCIe Interface

The PEB383 evaluation board implements a single lane PCIe Interface. It is designed to connect to a PCIe system with a standard x1 finger connector. The system must provide the REFCLK and PERSTN signals. The PCIe Interface has the following design elements:

- Supports hot insertion and removal
- Mid-bus logic analyzer pads for PCIe RXD/TXD signal probing
- AC coupling on the TXD lanes
- JTAG TDI - TDO loopback for chain continuity



The PCIE\_REXT signal must be tied to ground through a 190-ohm resistor.

## 1.4 Power Management

### 1.4.1 Power Regulation

The evaluation board's power regulation is implemented as follows:

- Digital 3.3V power supply available from DC/DC regulator or ATX supply
- Digital 1.0V switching regulator
- PCIe supplies filtered using EMI ferrite networks

To support PCI cards, the following additional power resources are included:

- 12V to 5V DC/DC converter
- 12V to 3.3V DC/DC converter
- External power connectors – ATX 20-pin connector for supplying all power from an ATX power supply

## 1.4.2 Power Requirements

The power requirements and implementation for the PEB383 is as follows.

**Table 3: PEB383 Power Requirements**

Supply Name	Symbol	Supplied Source
Device Core 1.0V	1.2V_384	DC/DC switching regulator w/Enable pin
PCIe 1.0V Core	1.2V_A_384	Passive Filter
PCI 3.3V supply	3.3V_384	Power switch w optional Ferrite filter to reduce EMI/noise from PCI environment
PCIe 3.3V supply	3.3V_A_384	Passive Filter

The target power draw of the PEB383 is a maximum of 1W, all supplies combined. The supplies to the PEB383 are controlled during ramp up using enable pins on regulators and switches.

### 1.4.2.1 PCIe

The *PCIe CEM Specification 1.1* defines power limits on PCIe slots according to the number of lanes available on a card. Power rules regarding x1 PCIe slots are a maximum of 25W slot. Current limits are included in [Table 4](#).

**Table 4: PCIe Connector Current Limits**

Rail	Current
3.3V	3A
12V	2.1A

The usage of the 12V supply provides access to the full 25W available from the system to the board. The PCIe pinout design includes more 12V power pins as it allows more power-per-pin capability. The evaluation board regulates all power from the 12V system rail; however, 3.3V from the system remains unused.

**1.4.2.2 PCI**

The PCISIG defines the power rules regarding PCI cards as a maximum of 25 Watts per card (All power rails combined power draw). The individual current limits on voltage rails are included in [Table 5](#).

**Table 5: PCI Connector Current Limits**

Rail	Current
3.3V	7.6a
5V	5a
-12V	100ma
12V	500ma

It is not possible to provide the full power required to the PCI bus without violating the specification while drawing power from only a x1 PCIe system. Up to 23W not including regulator efficiency losses can be made available. The evaluation board provides the power requirements in one of two ways depending on the application:

- PCIe system power
- ATX System connector

The following conditions summarize the power available for a single PCI card without external supply. An efficiency of 85% is taken into account for switching regulators. These limits can be exceeded in cases where the system can provide more than the suggested limit, which is usually only implemented in hot swap systems.

**Table 6: PCI Connector Current Limit with No External Supply**

Rail	Supplying Topology	Current (Maximum)
3.3V	12V to 3.3V regulator	6A
12V	12V directly	500mA
-12V	N/A	N/A
5V	12V to 5V regulator	4A

For additional slots, or in cases where the system cannot supply enough power, a separate ATX power connector is used to power the card. The evaluation board senses the presence of this supply, and disables the slave PCIe slot power. For the case of a separate external ATX supply, all four slots are provided with the required power.

### 1.4.3 Power Sequencing

On power-up, the board's power sequence is as follows:

1. 1.0V powered on
  2. PCI I/O slot power and pull-ups, and 3.3V
- 12V/-12V/5V PCI are not sequence controlled.

### 1.4.4 System Power Design

Figure 2 illustrates the power distribution for the riser card. The following list is a functional summary of the power design:

1. Sequencing control over the following rails:
  - 3.3V PCI
  - 3.3V PEB383 I/O/PCIe  $A_{VDD}$
  - 1.0V PEB383/PEB383 Core/PCIe  $V_{DD}$
2. ATX 20-pin connector override, which disables all power draw from the PCIe system.

Figure 2: System Power Distribution

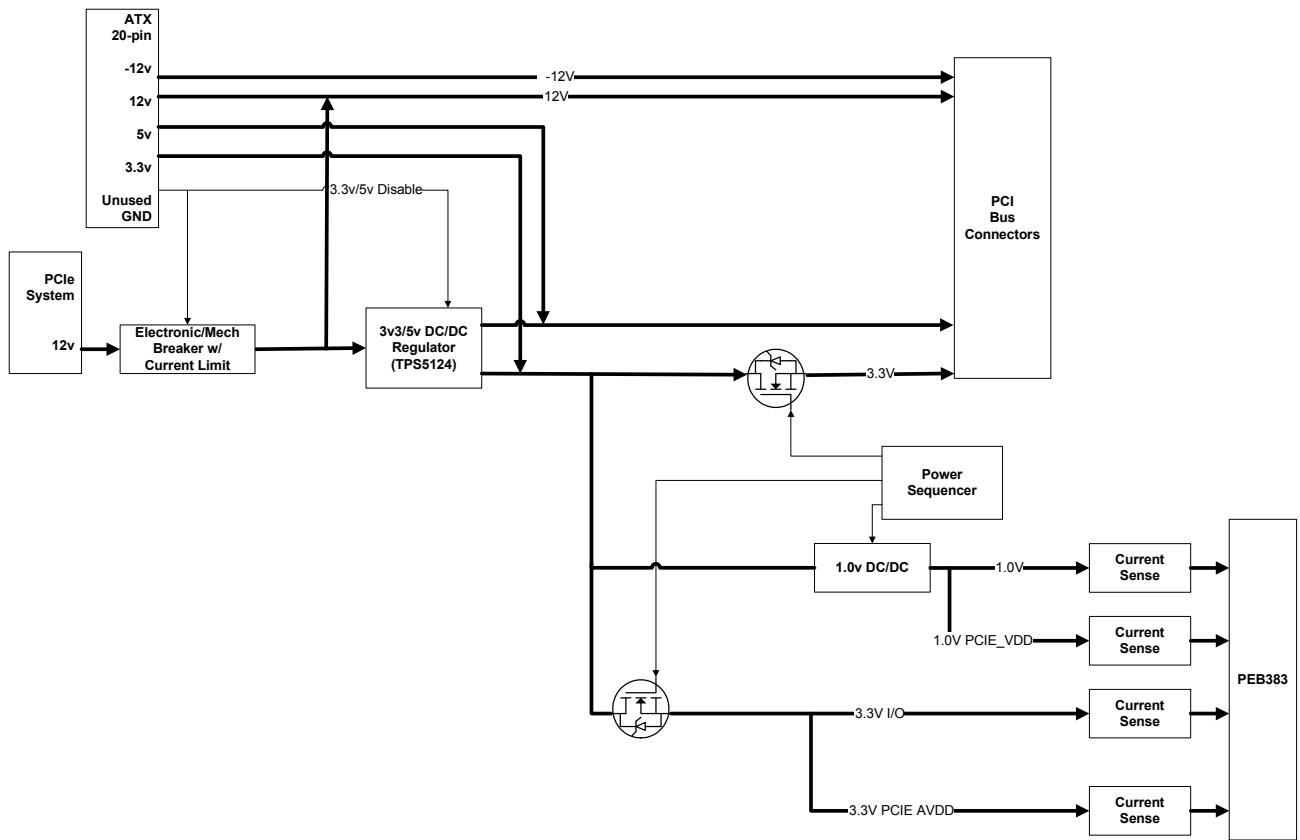

### 1.4.5 PCI Vaux (PCI Auxiliary) Support

PCI connectors are provided with a 3.3V supply to the vaux pins only during operation. There is no support for this power supply in standby mode. This feature is not documented in the PEB383 evaluation board schematic.

## 1.5 Clock Management

The PEB383 requires up to two input clocks to operate:

- 25–66 MHz clock for PCI
- 100-MHz reference clock for PCIe

The PCI and PCIe input clocks are briefly discussed.



The PEB383 supports five PCI clock outputs, PCI\_CLKO[0:4]. The PEB383 evaluation board demonstrates only PCI\_CLKO[0:1].

### 1.5.1 PCI

The evaluation board supports master and slave clocking for PCI.

- Master – When in master mode, the PEB383 generates the required PCI clock for all slots.
- Slave – When in slave mode, an on-board selectable 25–66 MHz clock generator is used.

On-board resistor muxes are used to multiplex either PEB383's PCI clock or the external clock generator.

#### 1.5.1.1 PCIe

For PCIe clocking, a 100-MHz differential HCSL clock source is required. The clock source is available in two forms:

- Edge connector clock source – This clock source synchronizes the system SerDes with the PEB383.
- On-board 100-MHz reference – This clock source can separate the clock domains between the bridge and the root complex.

The two PCIe clock sources are multiplexed with an analog multiplexer to select between the system clock or on-board clock (see [Figure 3](#)).

## 1.5.2 System Clock Distribution

The following figure shows the distribution of the system clock on the PEB383 evaluation board.

Figure 3: System Clock Distribution

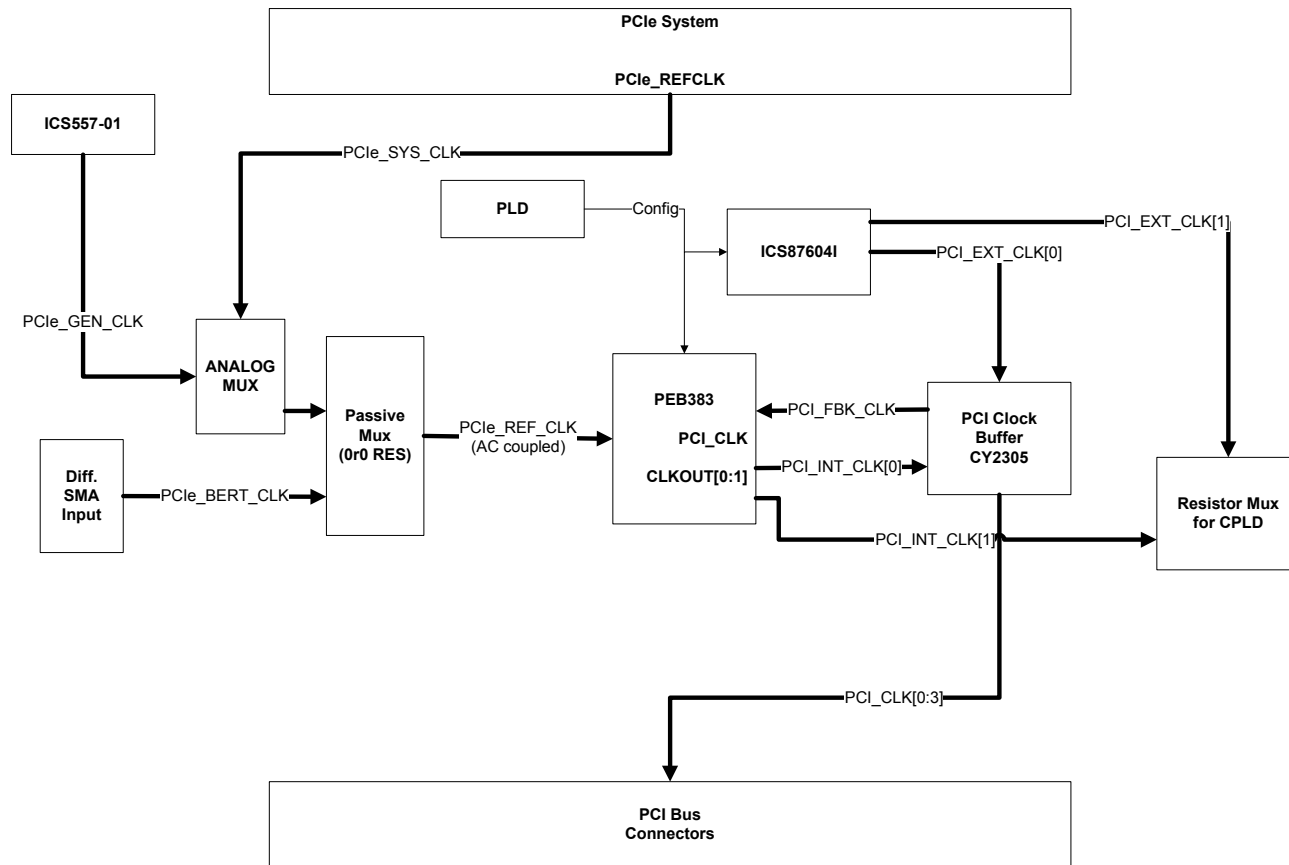

## 1.6 Other Interfaces

### 1.6.1 JTAG Interface

To support debug and testing of device, JTAG access to the PEB383 is available using a standard JTAG header for Wiggler connection.



For more information about accessing the PEB383 using JTAG, see the *JTAG Register Access Software Application Note*.

### 1.6.2 EEPROM Interface

A single EEPROM device socket is available for programming the PEB383's registers during startup. The socket is in an 8-pin DIP format.

### 1.6.3 GPIO Interface

The GPIO Interface is comprised of the following:

- On-board LEDs on GPIO lines
- Available 100mil Header to send/receive external 3.3V level signals

The following list outlines the connections to GPIO:

- External I/O header:
  - J7.1: NC
  - J7.2: GPIO0
  - J7.3: GPIO1
  - J7.4: GPIO2
  - J7.5: GPIO3
  - J7.6: Connected to ground
- LEDs:
  - D11: GPIO0, active led when driven low
  - D1: GPIO1, active led when driven low
  - D13: GPIO2, active led when driven low
  - D12: GPIO3, active led when driven low

## 1.7 Hardware Reset

The following figure shows the reset options of the PEB383 evaluation board.

**Figure 4: Board Reset**

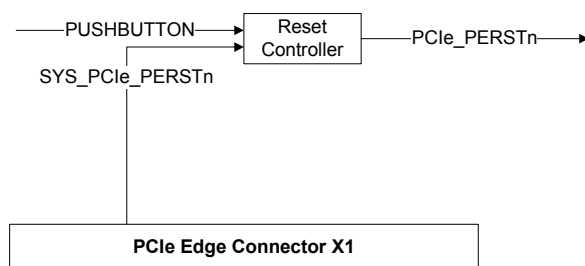



Three levels of reset are available:

- Cold reset – This reset is applied during power up. System (card edge) PCIe\_PERSTn is muxed with the board's reset controller.
- Warm reset – This reset is activated by a push-button reset on the board.
- Hot reset – This reset is activated by the in-band message sent by the root complex. No supporting hardware is necessary.



For more information on cold, warm, and hot reset levels, see the “Resets, Clocking, and Initialization Options” chapter in the *PEB383 User Manual*.

## 1.8 Logic Analyzer Connectivity

The serial buses have Midbus pads (TMS818 probe) for visibility of SerDes lines using a pre-processor. Each probing pad provides access to the RX and TX segments of a x1 link.

To access the PCI bus, a Nexus PCI interposer card can be used with Tektronix mictor cables. The card can be plugged into any PCI edge slot, or in-line with the device under test.



## 2. Configurable Options

Topics discussed include the following:

- “Switches” on page 19
- “Shunt Jumpers” on page 24
- “Debug Headers” on page 26
- “Connectors” on page 29
- “LEDs” on page 31

### 2.1 Switches

#### 2.1.1 DIP Switches

Switches S1 to S6 combine four, small slide switches identified with numbers 1 to 4 (see [Table 7](#) for individual switch definition).

**Figure 5: DIP Switch Package/Individual Switch Position**

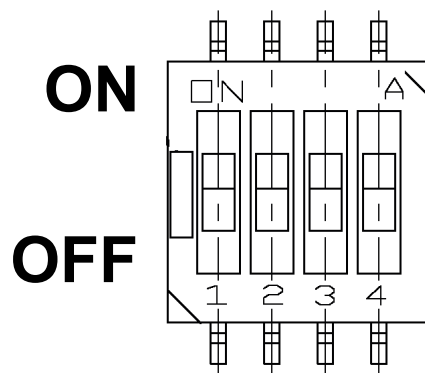
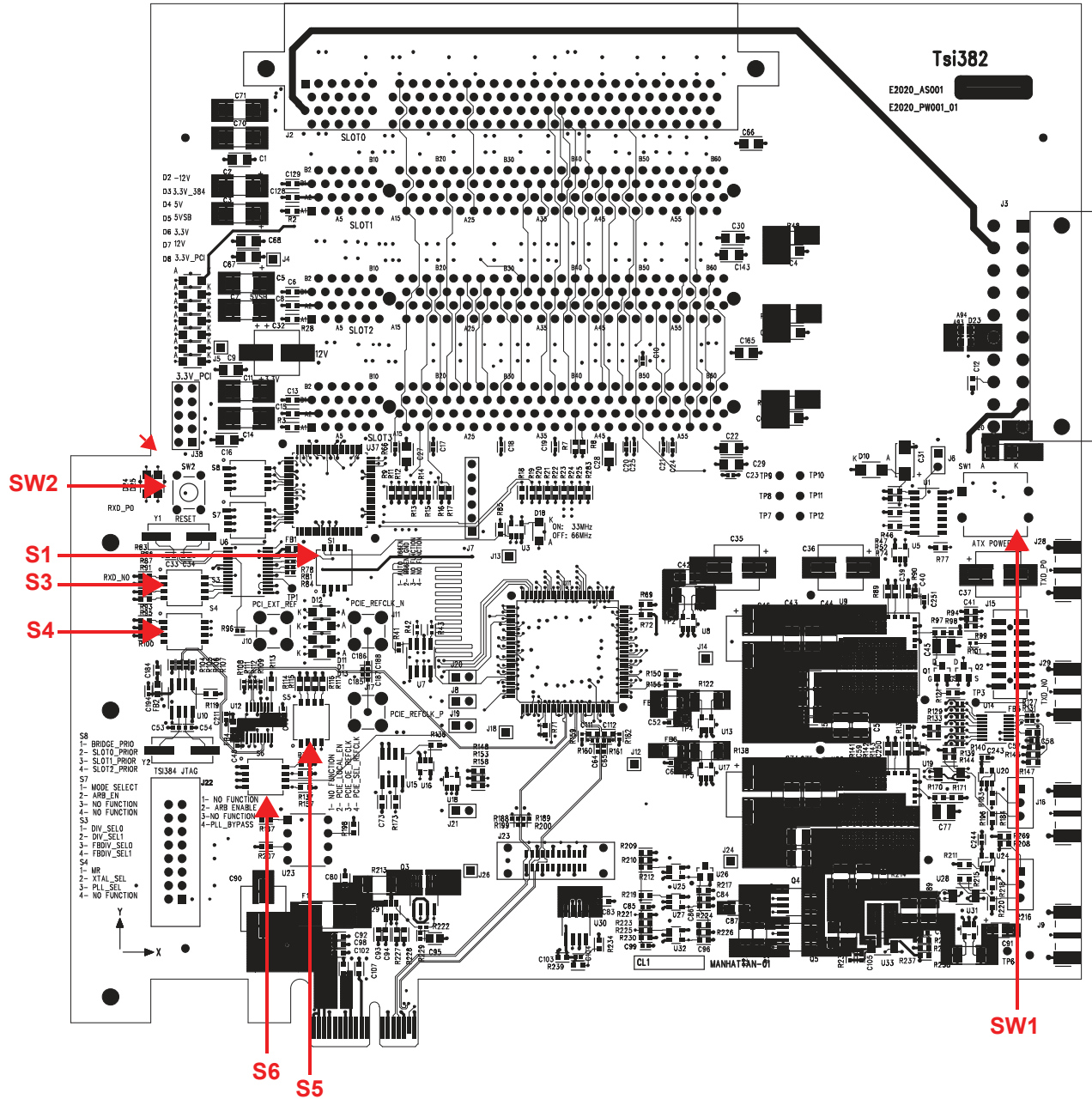

Figure 6: Switch Locations



Switch S1 is used to manually set PCI bus modes.

**Table 7: S1 Settings**

Switch Number	Description	Default Setting	On/Off Setting
1	M66EN	ON	ON = Connects M66EN to all cards OFF = Forces M66EN high if S1.2 OFF
2	M66EN	OFF	ON = Forces M66EN to GND OFF = Disables forcing M66EN to GND

Switches S3 and S4 are used to set the PCI bus external clock frequency. By default the PCI bus clock source is the PEB383. The external clock can only be connected to the PCI bus by replacing resistors on the board. When an external clock source is used, an on-board PLL is used to set the proper bus clock frequency. Table 8 contains the clock frequency settings for S3.

**Table 8: S3 Settings**

Switch Number	Description	Default Setting	On/Off Setting
1	DIV_SEL0	OFF	[FBDIV_SEL1, FBDIV_SEL0, DIV_SEL1, DIV_SEL0] ON = 1 OFF = 0 0,0,0,0 = x 4 0,0,0,1 = x 3 0,0,1,0 = x 2 0,0,1,1 = x 1 0,1,0,0 = x 5.33 0,1,0,1 = x 4 0,1,1,0 = x 2.667 0,1,1,1 = x 1.33 1,0,0,0 = x 6.667 1,0,0,1 = x 5 1,0,1,0 = x 3.33 1,0,1,1 = x 1.67 1,1,0,0 = x 8 1,1,0,1 = x 6 1,1,1,0 = x 4 1,1,1,1 = x 2
2	DIV_SEL1	OFF	
3	FBDIV_SEL0	OFF	
4	FBDIV_SEL1	OFF	

Switch S4 controls the external clock PLL.

**Table 9: S4 Settings**

Switch Number	Description	Default Setting	On/Off Setting
1	PLL Reset	ON	ON = PLL in reset. PLL clock outputs are low. OFF = PLL is active and clock outputs are enabled.
2	XTAL select	OFF	ON = Clock source for PLL is reference clock from connector J10 OFF = Clock source for PLL is a 25-MHz oscillator.
3	PLL select	OFF	ON = PLL is bypassed. OFF = PLL is enabled. External clock source is multiplied as per S3 setting
4	No function	-	-

Switch S5 controls the PCIe clock multiplexer and the on-board PCIe reference clock PLL.

**Table 10: S5 Settings**

Switch Number	Description	Default Setting	On/Off Setting
1	No Function	-	-
2	PCIe on-board PLL enable	ON	ON = On-board PCIe reference clock PLL is disabled. OFF = On-board PCIe reference clock PLL is enabled.
3	PCIe clock multiplexer enable	OFF	ON = On-board PCIe clock multiplexer is disabled. OFF = On-board PCIe clock multiplexer is enabled.
4	PCIe clock source select	OFF	ON = On-board PCIe reference clock is used. OFF = System PCIe reference clock is used.

Switch S6 configures PEB383's power-up options.

**Table 11: S6 Settings**

Switch Number	Description	Default Setting	On/Off Setting
1	No function	-	-
2	Internal arbiter option	ON	ON = Internal arbiter is enabled OFF = Internal arbiter is disabled
3	No function	-	-
4	PCI PLL bypass	ON	ON = PLL is enabled OFF = PLL is bypassed

### 2.1.2 Push Button

SW1 is used to turn the ATX power supply ON. This switch is used only when the PEB383 evaluation board is powered up with a stand-alone ATX power supply.

SW2 is used to reset the evaluation board. When pushing the reset button, the board is reset the same way a PCIe system reset would reset the board.

## 2.2 Shunt Jumpers

Shunt jumpers control special features on the evaluation board (see Figure 7). These jumpers are explained in the following sub-sections.

Figure 7: Shunt Jumper Locations

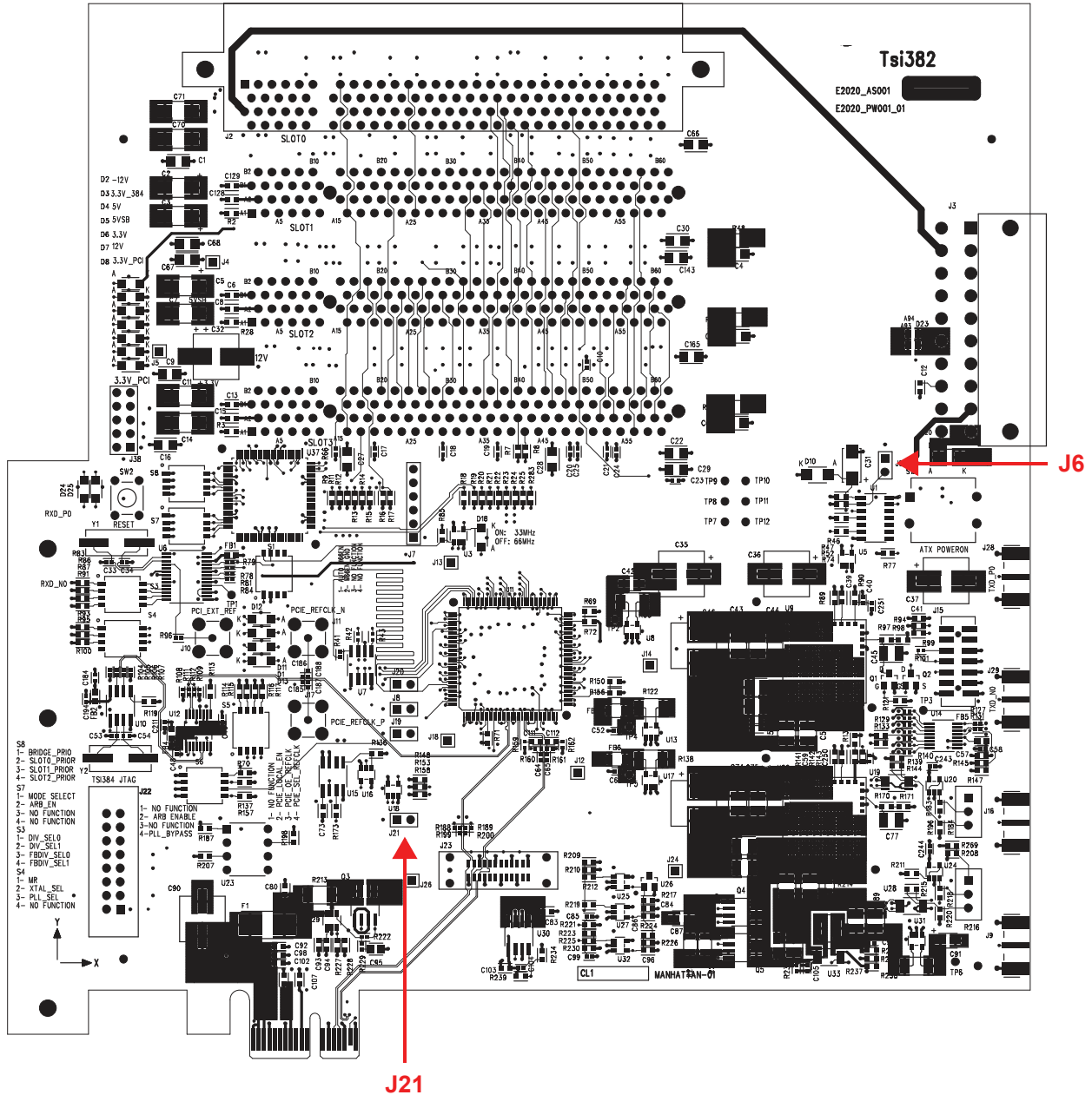



### 2.2.1 J6 Shunt Jumper

J6 is used to bypass the On/Off push button to enable the ATX power supply.

**Table 12: J6 Shunt Jumper Setting**

Jumper Setting	Default Setting	Function
Installed	Removed	Forces ATX power supply ON.
Removed		Normal operation, ATX power supply is turned On/OFF from push button.

### 2.2.2 J21 Shunt Jumper

J21 is used to force the PEB383 into a special debug mode. The default setting for this jumper is ON.

## 2.3 Debug Headers

Debug headers are used to connect to signals on the evaluation board. This section provides header pinouts.

Figure 8: Debug Header Locations

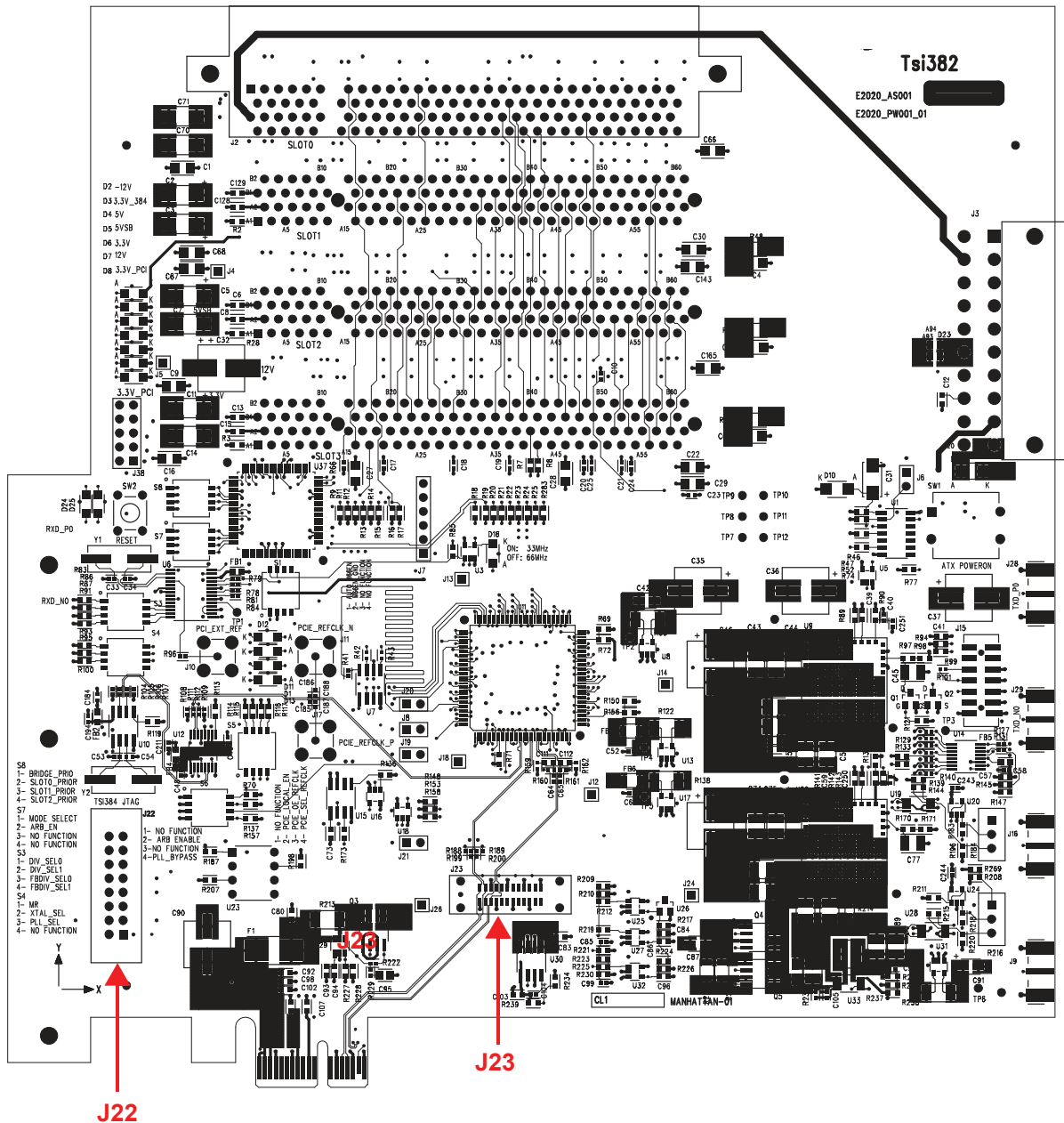

2.3.1 J22 PEB383 JTAG

Table 13: J22 Pin Assignment

Pin Number	Signal Assignment	Pin Location
1	TDO	<p style="text-align: center;"><b>J22</b></p>
2	NC	
3	TDI	
4	3.3V	
5	NC	
6	3.3V	
7	TCK	
8	NC	
9	TMS	
10	NC	
11	NC	
12	GND	
13	NC	
14	NC	
15	NC	
16	GND	

### 2.3.2 J23 Logic Analyzer PADS

Table 14: J23 Pin Assignment

Pin Number	Signal Assignment	Pin Location
1	PCIE_RXD_EDG_P0	
2	GND	
3	PCIE_RXD_EDG_N0	
4	PCIE_TXD_EDG_P0	
5	GND	
6	PCIE_TXD_EDG_N0	
7	N/C	
8	GND	
9	N/C	
10	N/C	
11	GND	
12	N/C	
13	N/C	
14	GND	
15	N/C	
16	N/C	
17	GND	
18	N/C	
19	N/C	
20	GND	
21	N/C	
22	N/C	
23	GND	
24	N/C	

## 2.4 Connectors

Figure 9: Board Connector Locations

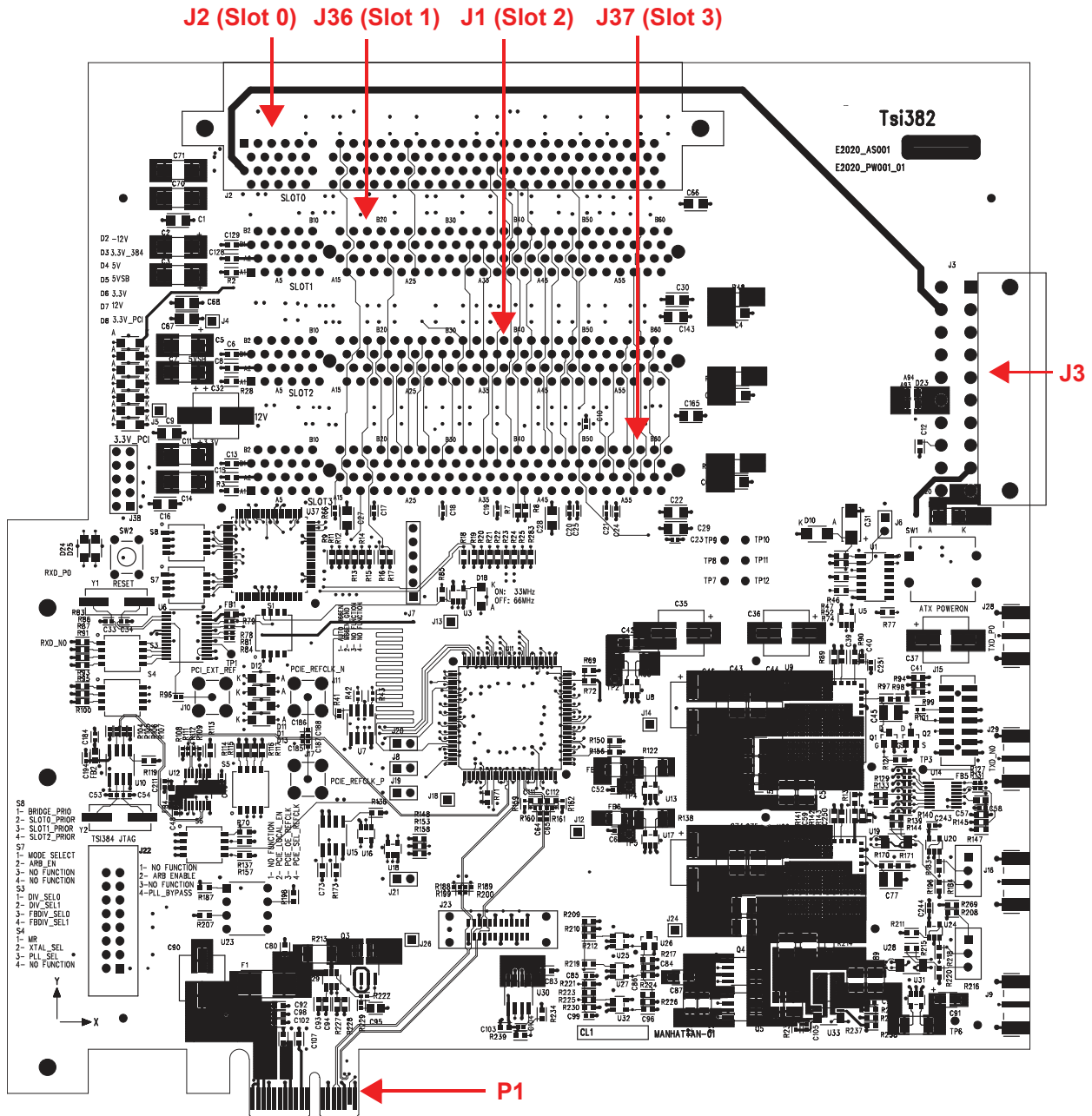

### 2.4.1 J1, J2, J36, J37 Connectors

These connectors are used to connect a plug-in card to the PEB383's PCI Interface. The connectors' pin assignments are as per the PCI standard for 32-bit connectors.

### 2.4.2 J3 ATX Power Connector

A standard ATX power supply can be used to power up the board when used stand alone (not plugged into a PCIe system).

**Table 15: J3 Pin Assignment**

Pin Number	Signal Assignment	J3 Pin Location
1	3.3V	
2	3.3V	
3	GND	
4	5V	
5	GND	
6	5V	
7	GND	
8	N.C.	
9	5VSB	
10	12V	
11	3.3V	
12	-12V	
13	GND	
14	GND	
15	GND	
16	GND	
17	GND	
18	N.C.	
19	5V	
20	5V	

### 2.4.3 P1 x1 PCIe Finger Connector

The pin assignment for the finger connector is as per the PCIe standard. Note that the JTAG signals TDI and TDO are connected together on the board.

## 2.5 LEDs

Figure 10: LED Locations

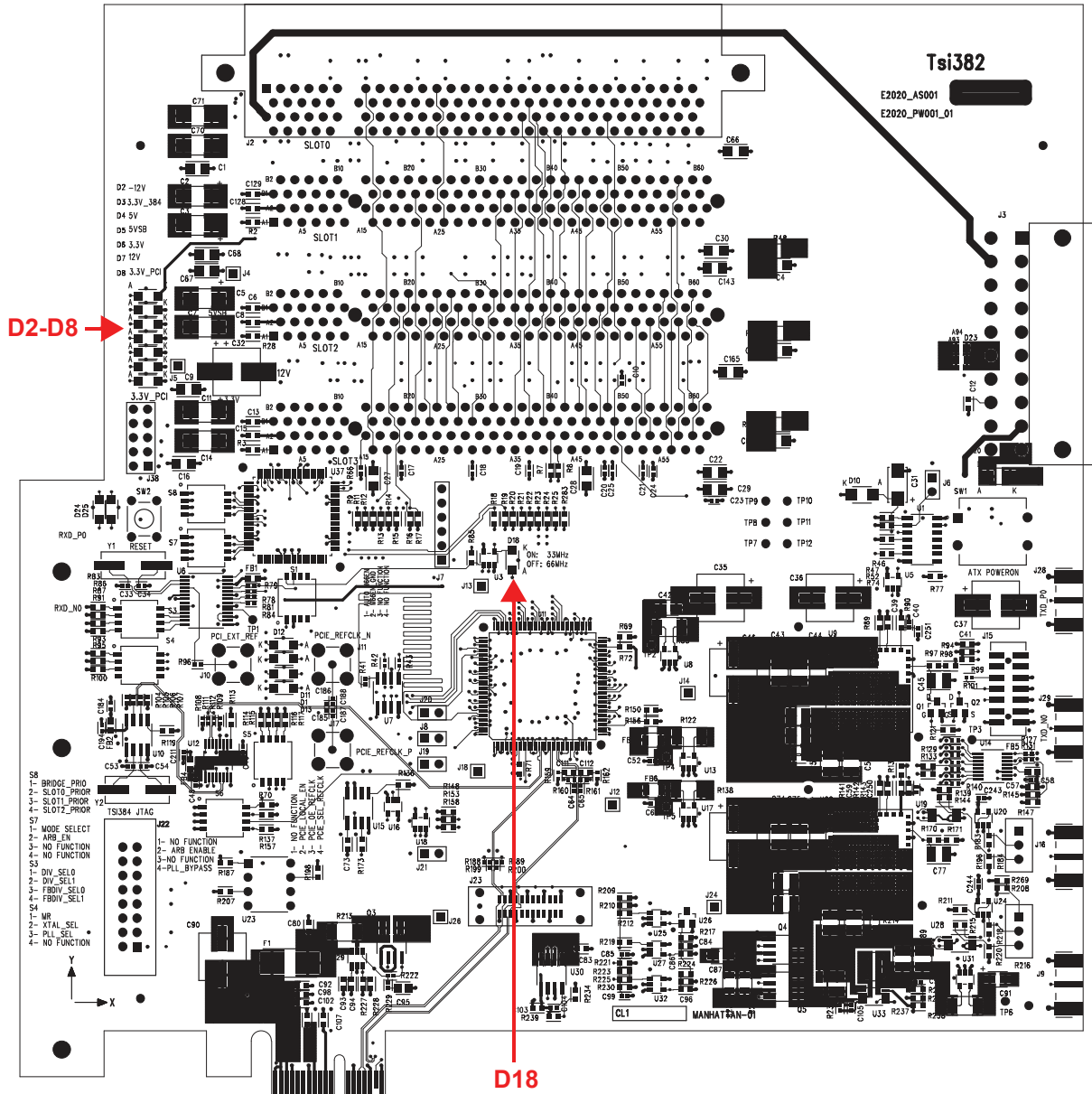







## IMPORTANT NOTICE AND DISCLAIMER

RENESAS ELECTRONICS CORPORATION AND ITS SUBSIDIARIES (“RENESAS”) PROVIDES TECHNICAL SPECIFICATIONS AND RELIABILITY DATA (INCLUDING DATASHEETS), DESIGN RESOURCES (INCLUDING REFERENCE DESIGNS), APPLICATION OR OTHER DESIGN ADVICE, WEB TOOLS, SAFETY INFORMATION, AND OTHER RESOURCES “AS IS” AND WITH ALL FAULTS, AND DISCLAIMS ALL WARRANTIES, EXPRESS OR IMPLIED, INCLUDING, WITHOUT LIMITATION, ANY IMPLIED WARRANTIES OF MERCHANTABILITY, FITNESS FOR A PARTICULAR PURPOSE, OR NON-INFRINGEMENT OF THIRD PARTY INTELLECTUAL PROPERTY RIGHTS.

These resources are intended for developers skilled in the art designing with Renesas products. You are solely responsible for (1) selecting the appropriate products for your application, (2) designing, validating, and testing your application, and (3) ensuring your application meets applicable standards, and any other safety, security, or other requirements. These resources are subject to change without notice. Renesas grants you permission to use these resources only for development of an application that uses Renesas products. Other reproduction or use of these resources is strictly prohibited. No license is granted to any other Renesas intellectual property or to any third party intellectual property. Renesas disclaims responsibility for, and you will fully indemnify Renesas and its representatives against, any claims, damages, costs, losses, or liabilities arising out of your use of these resources. Renesas' products are provided only subject to Renesas' Terms and Conditions of Sale or other applicable terms agreed to in writing. No use of any Renesas resources expands or otherwise alters any applicable warranties or warranty disclaimers for these products.

(Disclaimer Rev.1.0 Mar 2020)

### Corporate Headquarters

TOYOSU FORESIA, 3-2-24 Toyosu,  
Koto-ku, Tokyo 135-0061, Japan  
[www.renesas.com](http://www.renesas.com)

### Contact Information

For further information on a product, technology, the most up-to-date version of a document, or your nearest sales office, please visit:  
[www.renesas.com/contact/](http://www.renesas.com/contact/)

### Trademarks

Renesas and the Renesas logo are trademarks of Renesas Electronics Corporation. All trademarks and registered trademarks are the property of their respective owners.