

SPECIFICATIONS **SDDAN40R21W**

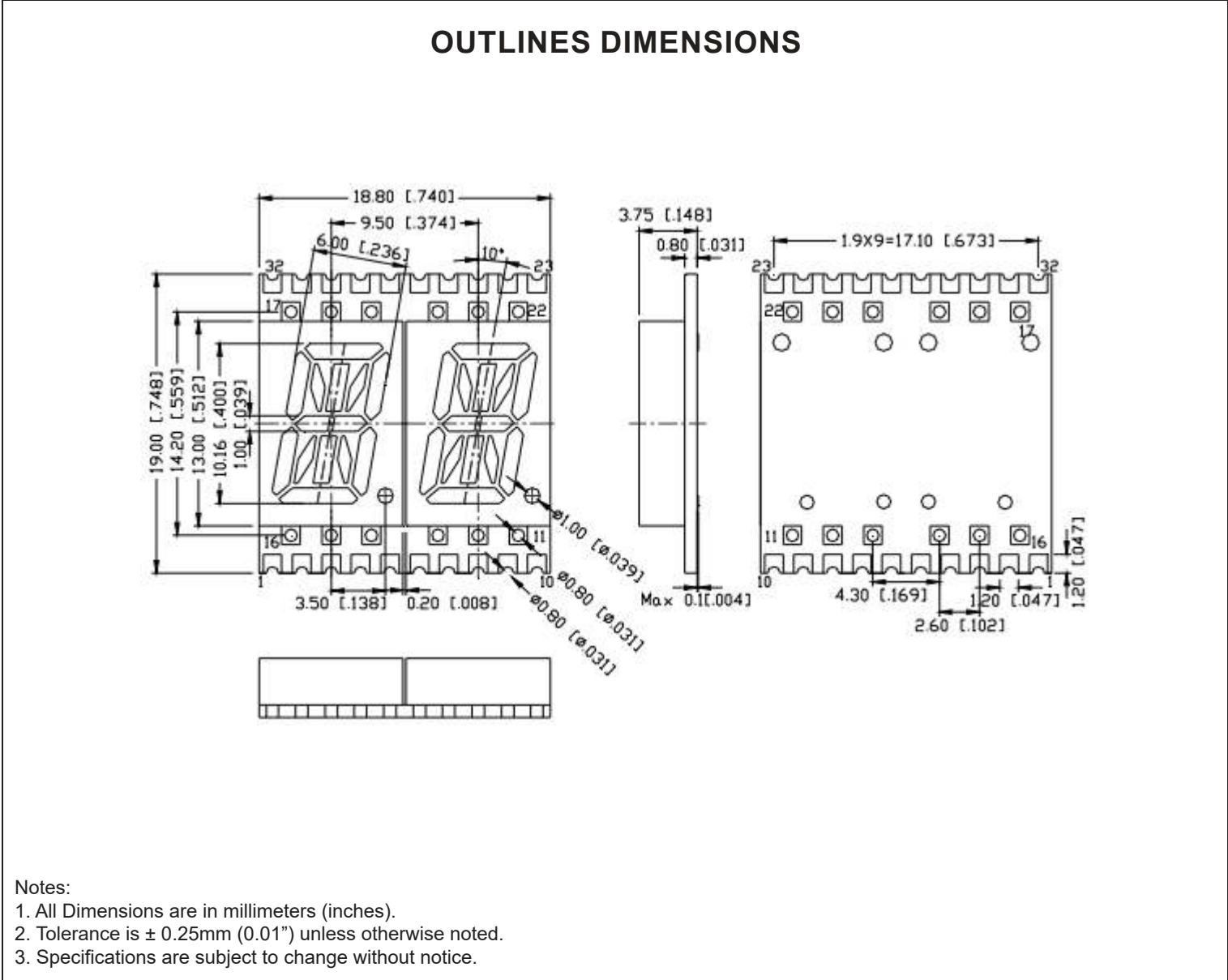

Part Number	Chip Material	Color of Emission	Lens Type	Description
SDDAN40R21W	InGaAlP	Red	White Segment	Common Anode



ChromeLED Corp. reserves the right to make changes at any time in order to supply the best product possible. The most current version of this document will always be available at: www.chromeled.com

TYPICAL INTERNAL EQUIVALENT CIRCUIT

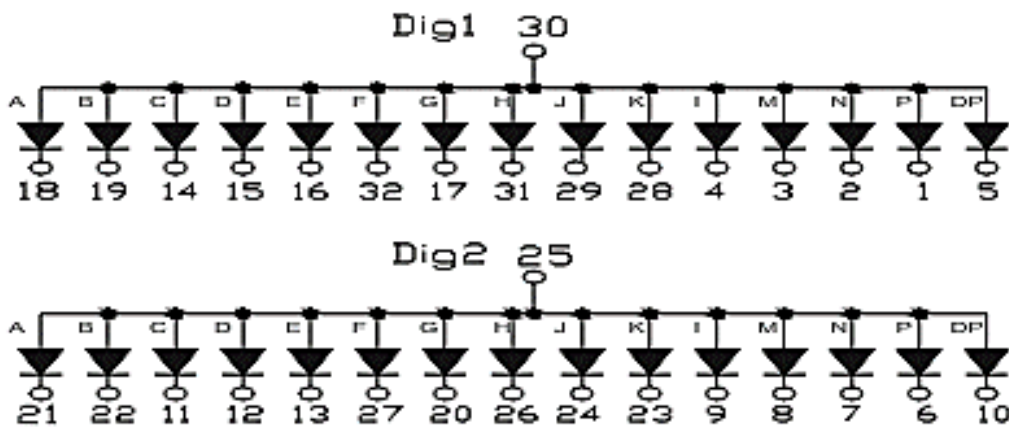
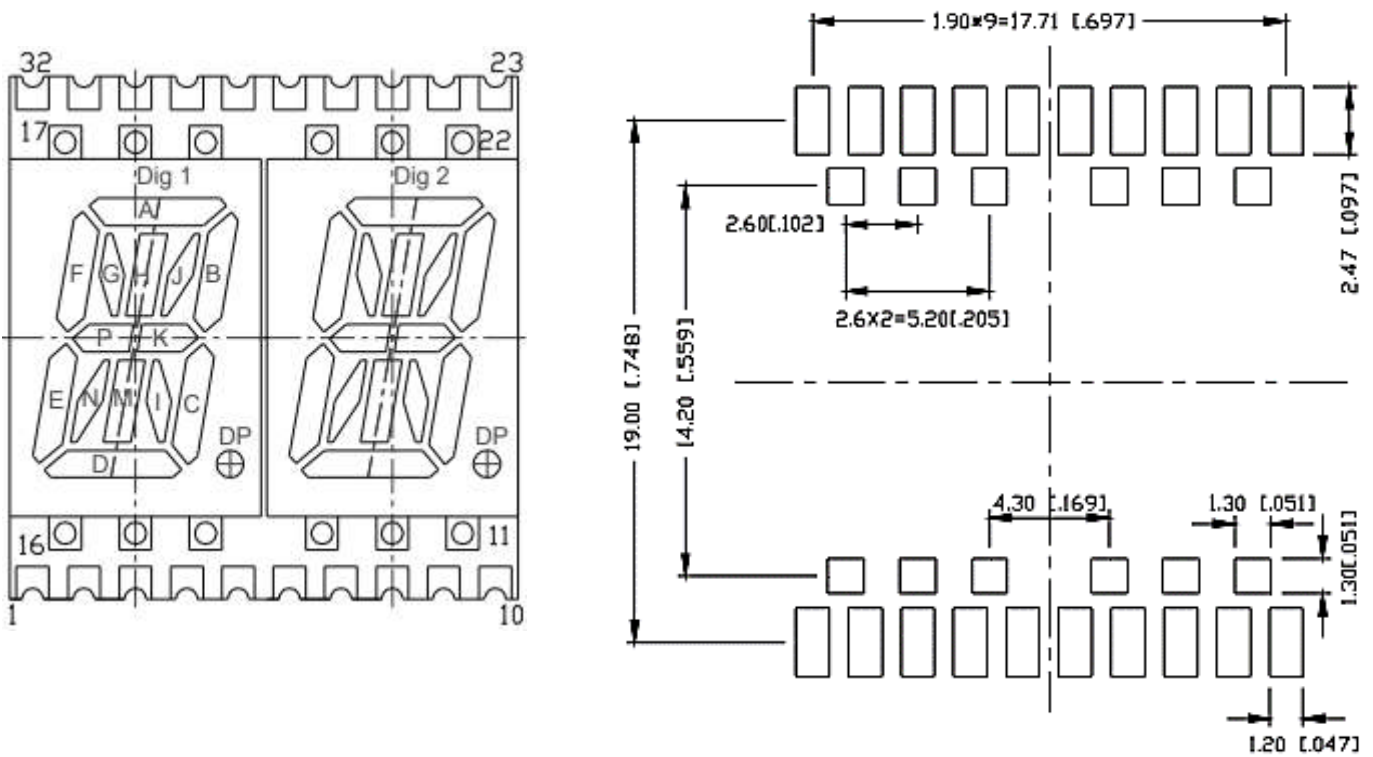

Common Anode



ChromeLED Corp. reserves the right to make changes at any time in order to supply the best product possible. The most current version of this document will always be available at: www.chromeled.com

ABSOLUTE MAXIMUM RATINGS (TA=25°C)

Parameter	Symbol	Max Rating	Unit
Power Dissipation	PD	70	mW
Pulse Forward Current	IFP	90	mA
Continuous Forward Current	IF	25	mA
Reverse Voltage Segment	VR	5	V
Operating Temperature Range	TOPR	-40~+105	°C
Storage Temperature Range	TSTG	-40~+105	°C
IFP = Pulse Width ≤ 10 ms, Duty Ratio ≤1/10. Soldering Condition: 260 °C/ 5sec			

OPTICAL-ELECTRICAL CHARACTERISTICS (TA=25°C)

Parameter	Symbol	Test Condition	Value			Unit
			Min	Typ	Max	
Luminous Intensity	IV	IF = 20mA	-	7	-	mcd
Forward Voltage (Per Dice)	VF	IF = 20mA	-	2.0	2.8	V
Reverse Leakage Current	IR	VR = 5V	-	-	100	µA
Dominant Wavelength	λd	IF = 20mA	-	630	-	nm
Peak Wavelength	Δp	IF = 20mA	-	644	-	nm



ChromeLED Corp. reserves the right to make changes at any time in order to supply the best product possible. The most current version of this document will always be available at: www.chromeled.com

OPTICAL CHARACTERISTIC CURVES

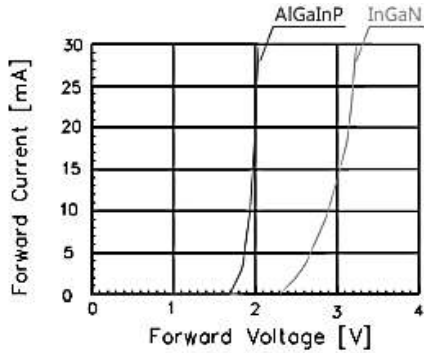

Fig 1. Forward Current vs. Forward Voltage

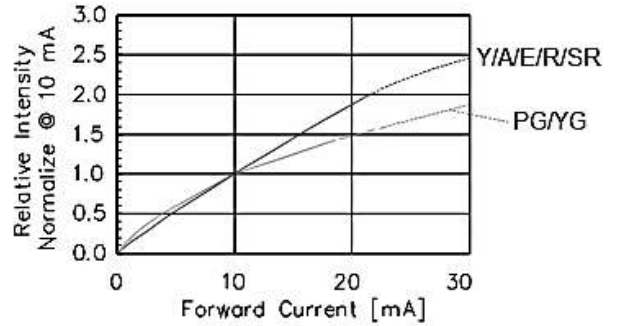

Fig 2. Relative Intensity vs. Forward Current

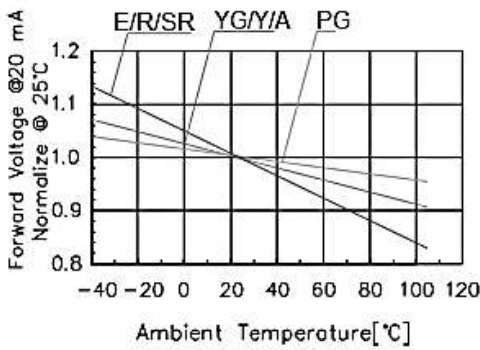

Fig 3. Forward Voltage vs. Temperature

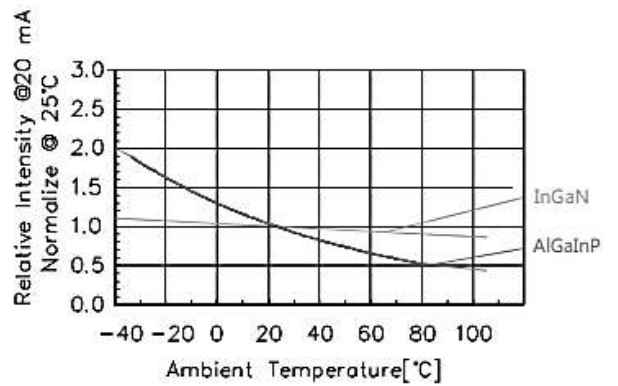

Fig 4. Relative Intensity vs. Temperature

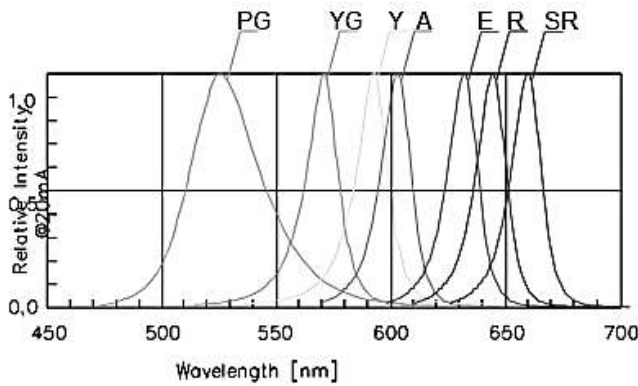

Fig 5. Relative Intensity vs. Wavelength

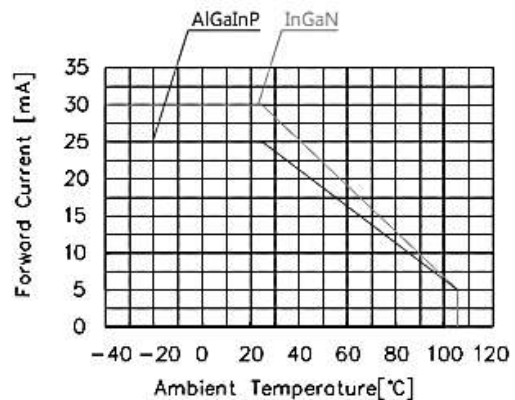

Fig 6. Forward current vs. Temperature



ChromeLED Corp. reserves the right to make changes at any time in order to supply the best product possible. The most current version of this document will always be available at: www.chromeled.com

SOLDERING CONDITIONS – DISPLAY TYPE LED
● SMT REFLOW SOLDERING INSTRUCTIONS

SMT Soldering Profile

Pb free reflow soldering Profile

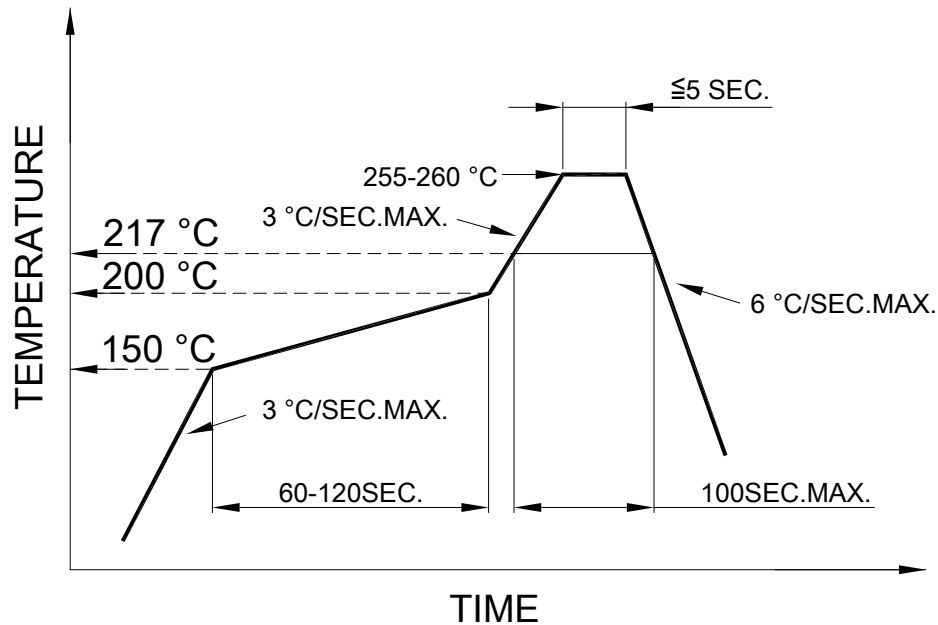
● SOLDERING IRON

Basic spec is ≤ 4 sec when 260°C. If temperature is higher, time should be shorter (+10°C → 1 sec). Power dissipation of Iron should be smaller than 15W, and temperature should be controllable. Surface temperature of the device should be under 230°C.

● REWORK

- Customer must finish rework within 3 sec. under 350°C.
- The head of soldering iron cannot touch copper foil.



ChromeLED Corp. reserves the right to make changes at any time in order to supply the best product possible. The most current version of this document will always be available at: www.chromeled.com

PACKAGING SPECIFICATION

REEL DIMENSION

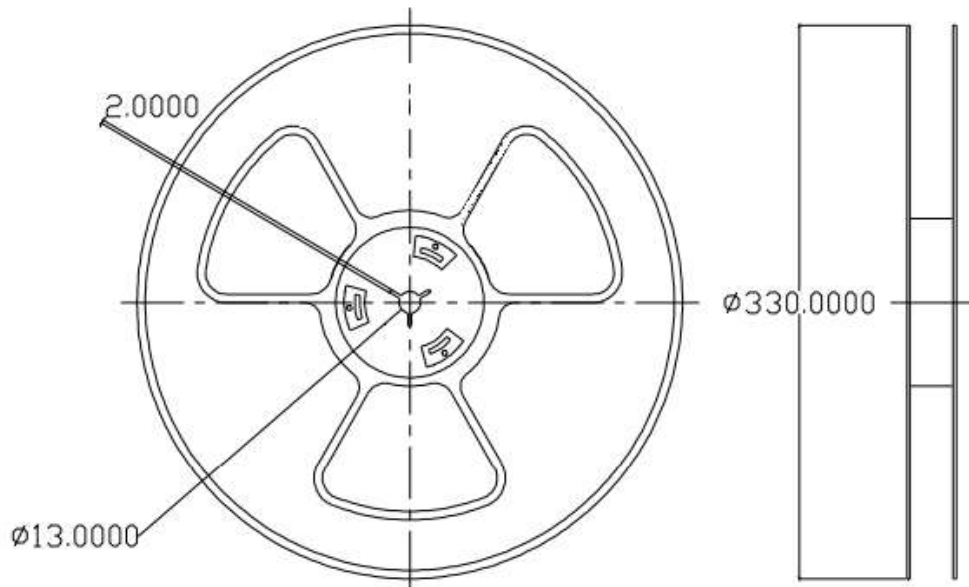

PACKING & LABEL DIMENSIONS

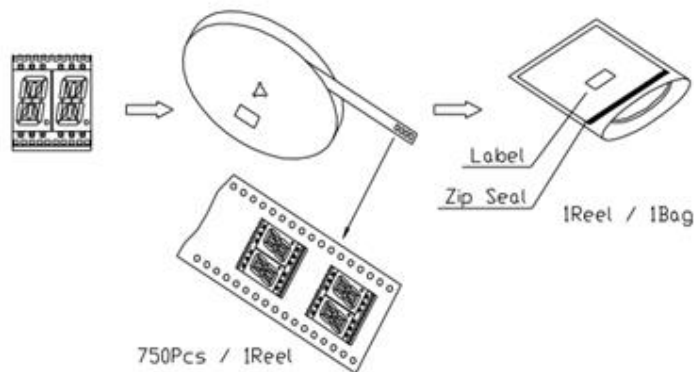

Note:

1. Specifications are subject to change without notice.
2. Please contact us for the updated information.



ChromeLED Corp. reserves the right to make changes at any time in order to supply the best product possible. The most current version of this document will always be available at: www.chromeled.com