

**This part is now OBSOLETE 1/22/2009**

**Not Recommended for new designs**

International  
**IR** Rectifier

Data Sheet No. PD 10057 revN

## Series PVY116 & PbF

Microelectronic Power IC  
HEXFET® Power MOSFET Photovoltaic Relay  
Single-Pole, Normally-Open, 0-40V AC/DC, 250mA

### General Description

The PVY116 Series Photovoltaic Relay is a single-pole, normally-open solid-state relay that can replace dry and Mercury-wetted reed relays in many applications. It utilizes International Rectifier's proprietary HEXFET power MOSFET as the output switch, driven by an integrated circuit photovoltaic generator of novel construction. The output switch is controlled by radiation from a GaAlAs light emitting diode (LED), which is optically isolated from the photovoltaic generator.

The PVY116 is ideally suited for use as matrix relay in low voltage ATE applications and general instrumentation applications involving high frequency test signals. This can be accomplished thanks to the extremely low Figure Of Merit ( $FOM = Coff * Ron$ ), which is the product of the relay's off-state output capacitance and on-state resistance.

The PVY116 is packaged in a 4-pin, molded small outline package (SOP-4) with surface mount (gull wing) terminals. It is available in plastic shipping tubes or on tape-and-reel. Please refer to Part Identification information.

### Applications

- Automated Test Equipment
- Instrumentation
- Data Acquisition

### Features

- Low signal distortion at high frequencies
- Low  $Coff * Ron$  Figure Of Merit
- High off-state resistance
- Bounce-free operation
- 1,500 V<sub>RMS</sub> I/O isolation
- Long operational life
- Solid-State Reliability
- ESD Tolerance 2000V Human Body Mode

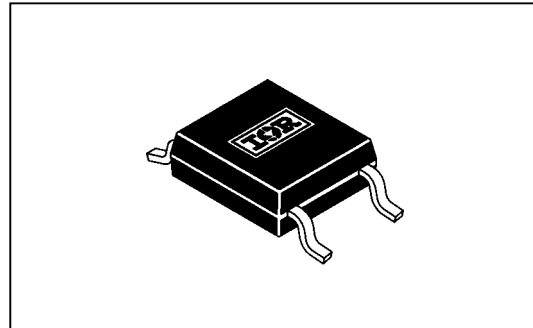

### Part Identification

PVY116 & PbF	surface-mount
PVY116-T & PbF	surface-mount, tape-and-reel

*(HEXFET is the registered trademark for International Rectifier's power MOSFETs)*

**Electrical Specifications** ( $-40^{\circ}\text{C} \leq T_A \leq +85^{\circ}\text{C}$  unless otherwise specified)

INPUT CHARACTERISTICS	Units	Min	Typ	Max
Minimum control current (see Figure 1)	mA	2.0	—	—
Control current for off-state resistance @ $T_A = +25^{\circ}\text{C}$	mA	—	—	0.2
Control current range (caution: current limit input LED, see Figure 8)	mA	2.0	—	20.0
Reverse voltage	V	—	—	6.0

OUTPUT CHARACTERISTICS	Units	Min	Typ	Max
Operating voltage range	V peak	—	—	40
Continuous load current @ $40^{\circ}\text{C}$ , 5mA control (see Figure 1)	mA	—	—	250
Pulsed load current @ $25^{\circ}\text{C}$ , 5mA control (see Figure 2 and 3) 10ms on, 10% duty cycle	mA	—	—	420
Off-state leakage @ 32V, $25^{\circ}\text{C}$ , (see Figure 4)	nA	—	0.02	1.0
On-state resistance @ 5mA control, $I_L = 100\text{mA}$ (see Figure 2 and 3)	$\Omega$	—	3.8	4.4
Output capacitance $V_d = 0\text{V}$ , $f = 1\text{MHz}$ ( $C_{out}$ , see Figure 7)	pF	—	2.4	3.0
$C * R$ ( $R_{D(on)} \times C_{out}$ )	pF * $\Omega$	—	9.1	—
Turn-on time, 5mA control, $100\Omega$ , 20V ( $T_{on}$ , see Figure 5) 1ms on, 50% duty cycle	$\mu\text{S}$	—	110	500
Turn-off time, 5mA control, $100\Omega$ , 20V ( $T_{off}$ , see Figure 5) 1ms on, 50% duty cycle	$\mu\text{S}$	—	100	500

GENERAL CHARACTERISTICS	Units	Min	Typ	Max
Dielectric strength, Input to Output	$V_{RMS}$	1500	—	—
Insulation Resistance, Input to Output	$\Omega$	$10^{12}$	—	—
$C_{I-O}$ (Input to Output Capacitance), $V_d = 0\text{V}$ , $f = 1\text{MHz}$	pF	—	0.8	—
Max. pin soldering temperature (10 seconds max.)	$^{\circ}\text{C}$			+260
Ambient temperature range: Operating	$^{\circ}\text{C}$	-40		+85
Storage	$^{\circ}\text{C}$	-40		+100

International Rectifier does not recommend the use of this product in aerospace, avionics, military or life support applications. Users of this International Rectifier product in such applications assume all risks of such use and indemnify International Rectifier against all damages resulting from such use.

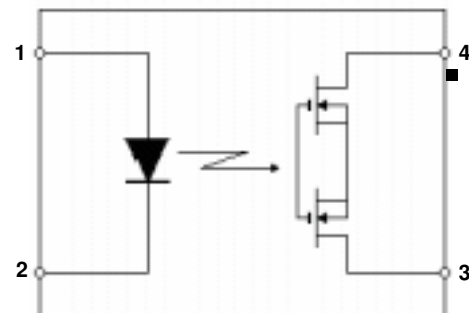

Connection Diagram

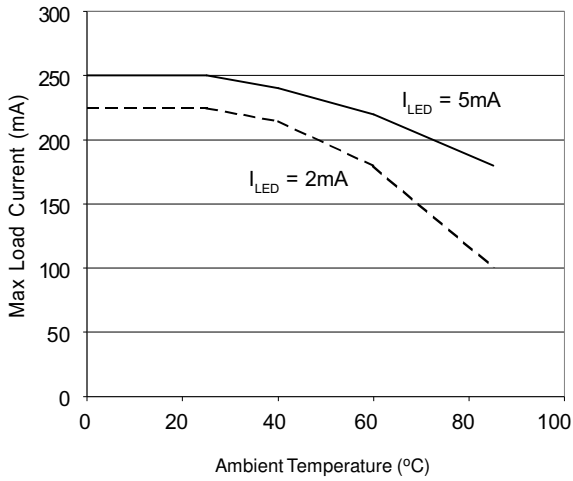

Figure 1. Current Derating Curves

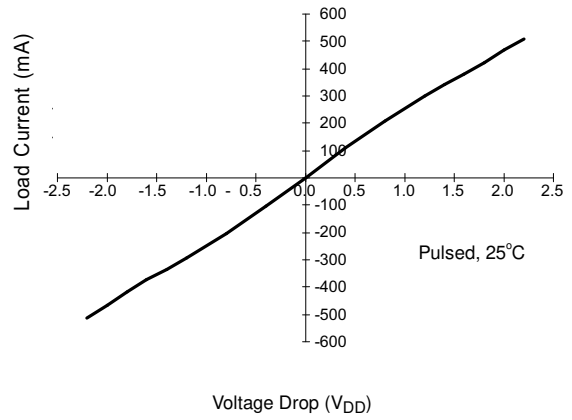

Figure 2. Typical On Characteristics

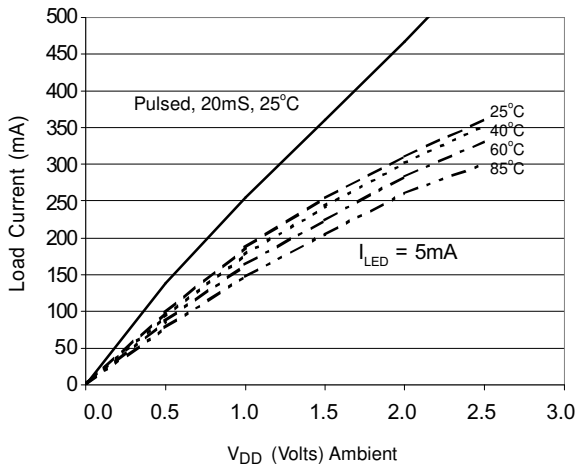

Figure 3. Typical On Characteristics

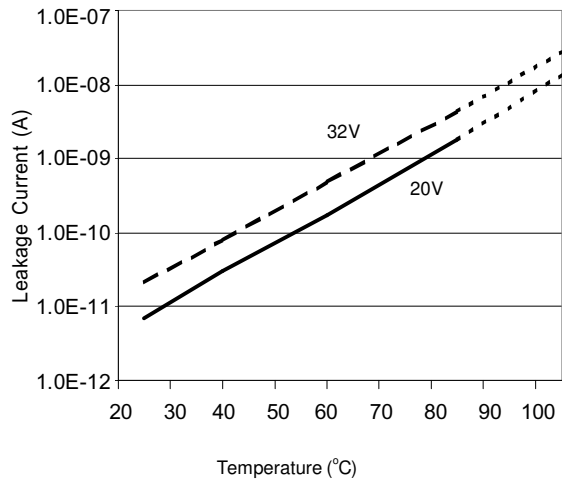
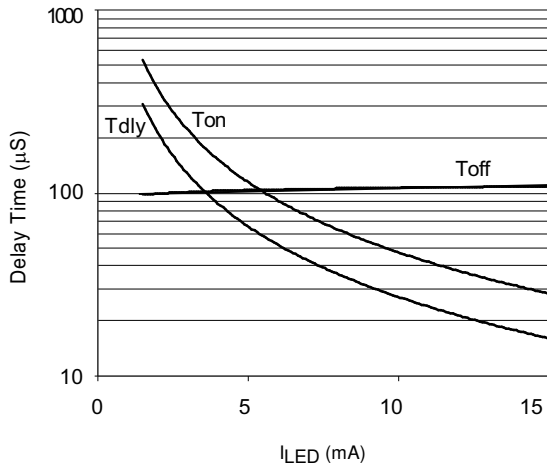
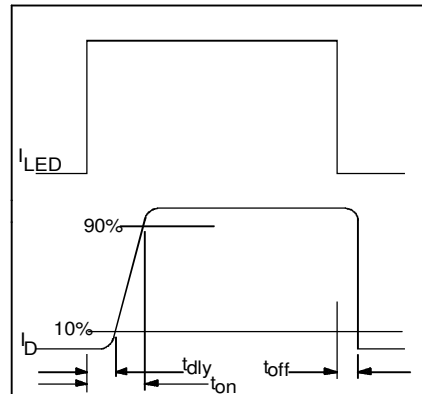

Figure 4. Typical Leakage Characteristics



**Figure 5. Typical Delay Times**



**Figure 6. Delay Time Definitions**

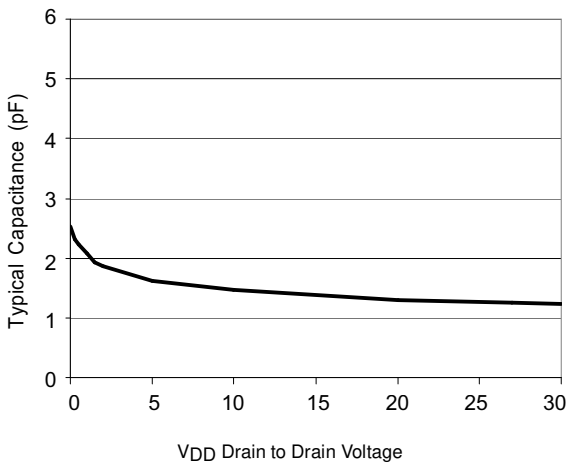

**Figure 7. Output Capacitance**

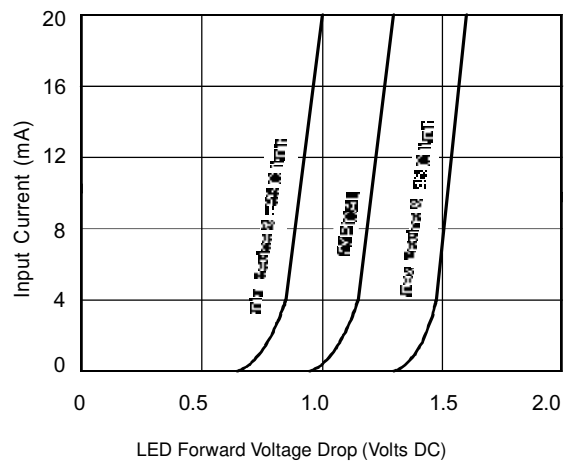

**Figure 8. Input Characteristics (Current Controlled)**

**Case Outlines - 4 Lead SOP**

