

IDS-3112

12" SVGA / XGA Industrial Open Frame Monitor

NEW



Features

- 12.1" SVGA / XGA LCD panel with LED backlight for 20% power savings, and environmental protection
- -20° C ~ +60° C wide range operating temperature
- 5-wire resistive and P-cap touch screen solution or 3mm tempered smudge resistant protected glass
- Combo touch interface, both RS-232 and USB
- Dual signal interface with VGA & DVI
- Integrated bracket for easy installation
- Versatile mounting method for rear mounting and VESA mounting
- Anti-Reflective treatment (optional)
- Ultra-high brightness: 1200 cd/m² for outdoor applications (optional)

Introduction

The Advantech IDS-3112 Embedded Open Frame Monitor series offers flexible options for LCD, touchscreen, signal interface and chassis mounting. The series supports rear and VESA mounting. The integrated brackets provide the benefits of easy installation, and flexibility for different applications.

Specifications

	Model	IDS-3112 (XGA)	IDS-3112 (SVGA)	IDS-3112E (SVGA)
Display	Size	12.1" LED panel	12.1" LED panel	12.1" LED panel
	Resolution	1024 x 768 (XGA)	800 x 600 (SVGA)	800 x 600 (SVGA)
	Viewing Angle	80°/80° (H), 70°/70° (V)	80°/80° (H), 65°/75° (V)	80°/80° (H), 65°/75° (V)
	Brightness	600 (cd/m ²)	450 (cd/m ²)	450 (cd/m ²)
	Color Support	16.2M/262K colors	16.2M/262K colors	16.2M/262K colors
	Contrast Ratio	700:1	700:1	700:1
	Response Time	16 [msec]	35 [msec]	35 [msec]
	Backlight Life (hrs)	50,000 hrs	50,000 hrs	50,000 hrs
	Touchscreen	T/S Type	5-Wire Resistive Touchscreen / Projected Capacitive Touchscreen	
Surface Hardness		3H / 7H		
Durability		10 million touches / -		
Transparency		80% / 90% ± 3%		
Environment	Operating Temperature	-20 ~ 60° C (-4 ~ 140° F)	-20 ~ 60° C (-4 ~ 140° F)	0~ 45° C (32 ~ 113° F)
	Storage Temperature	-30 ~ 70° C (-22 ~ 158° F)	-30 ~ 70° C (-22 ~ 158° F)	-20 ~ 60° C (-4 ~ 140° F)
	Humidity	5 ~ 95% @ 40° C, non-condensing		
	Vibration	5-500Hz, 0.026G ² /Hz, 2.16Grms, X, Y, Z 1 hour per axis		
System	I/O	VGA x 1; DVI-D x 1; 12V _{DC} Jack x 1; USB x 1; RS-232 x 1 (USB & RS-232 are reserved for the connection to enable touch usage only)	VGA x 1; DVI-D x 1; 12 V _{DC} Jack x 1; USB x 1; RS-232 x 1 (USB & RS-232 are reserved for the connection to enable touch usage only)	VGA x 1; 12 V _{DC} Jack x 1; USB x 1; RS-232 x 1 (USB & RS-232 are reserved for the connection to enable touch usage only)
	OSD	Keys; Menu, Up, Down, Auto Adjust, Monitor Power on/off Menu Function: Brightness, Contrast, Screen Setting, Color Temp, Language OSD settings, VGA/DVI, Recall, Auto Adjust	Keys; Menu, Up, Down, Auto Adjust, Monitor Power on/off Menu Functions: Brightness, Contrast, Screen Setting, Color Temp, Language OSD Settings, VGA/DVI, Recall, Auto Adjust.	Keys; Menu, Up, Down, Auto Adjust, Monitor Power on/off Menu Functions: Brightness, Contrast, Color Adjust, Color Temp, Auto Color, and Language
	Power	36 W power adapter, with AC 100 ~ 240 V input and DC +12V @ 3 A output		
	EMC Compliance	CE/FCC/CCC		

Dimensions

Unit: mm

IDS-3112 (XGA) Series

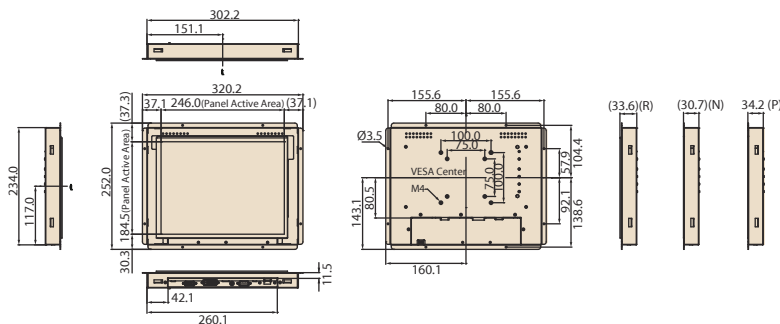

IDS-3112 (SVGA) Series

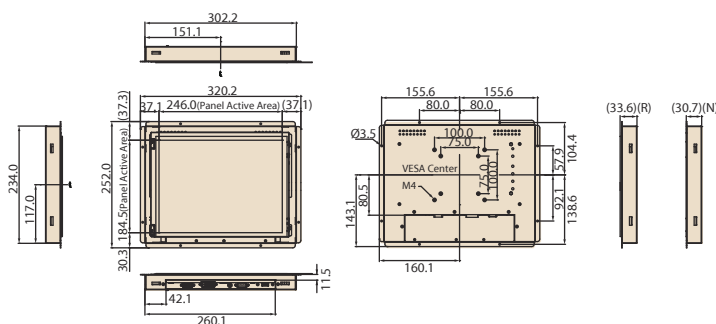

IDS-3112E (SVGA) Series

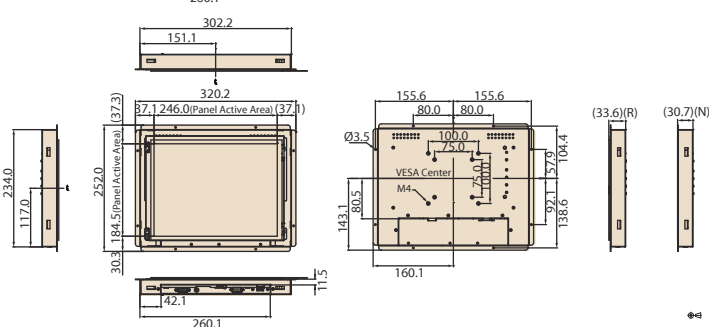

Packing List

Part Number	Description
1700002215	1 x M Cable USB-A(M)/USB-A(M) 180CM
1700021332-01	1 x VGA cable 15P(M) 180 cm
1962055040	4 x Clamper
1935042520	4 x Screw of clamper M4_25L
1992610005	1 x Cable clamp
1933030500	1 x Screw of cable clamp
1992602010	1 x Cable tie

* USB Cable is only included with IDS-3112R and IDS-3112ER series. Note: Package contents are subject to change without prior notice

Ordering Information

Model Name	Description
IDS-3112N-60XGA1E	12.1" XGA 600 cd/m ² LED Open Frame Monitor
IDS-3112R-60XGA1E	12.1" XGA 600 cd/m ² LED Open Frame Monitor with Res. Touch
IDS-3112N-45SVA1E	12.1" SVGA 450 cd/m ² LED Open Frame Monitor
IDS-3112R-45SVA1E	12.1" XGA 600 cd/m ² LED Open Frame Monitor with Res. Touch
IDS-3112EN-45SVA1E	12.1" SXGA 450 cd/m ² LED Open Frame Monitor
IDS-3112ER-45SVA1E	12.1" SVGA 450 cd/m ² LED Open Frame Monitor with Res. Touch
IDS-3112P-60XGA1	12.1" XGA 600 cd/m ² LED Open Frame Monitor with P-Cap Touch

Optional Items

Part Number	Description
1700001524	3-Pin Power Cord (USA)
170203183C	3-Pin Power Cord (EU)
1700008921	3-Pin Power Cord with PSE (Japan)
96PSA-A36W12R1	Adaptor AC100-240V 36W +12V/3A
1700000243-11	M cable DVI 19P(M)/DVI 19P(M) 191cm
1700091800	CABLE 9P/9P 1.8M M/F (T/S RS-232 Cable)