

PERM-O-PADS®

TO-5 Mounts

Material Specifications:

White or Natural Nylon, per ASTM D4066 PA111, UL Rated 94V-2

Oxygen Rating Index: Over 28%

Standard Drawing Tolerances:

(unless otherwise indicated)

Fractions: $\pm 1/64$ (0.4) .XX = ± 0.01 (0.25)

.X = ± 0.10 (2.5) .XXX = ± 0.005 (0.13)

513-075

Price Code: A

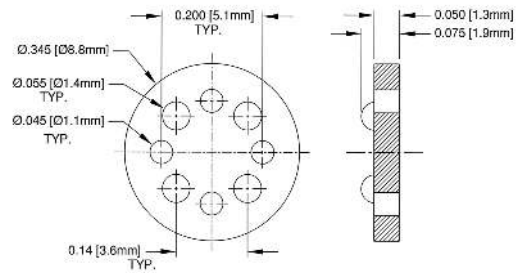

515-020

Price Code: A

A55485 / 02-018N

M38527 / 02-018N

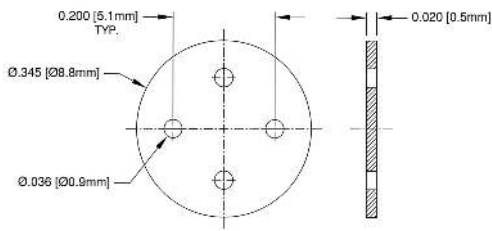

516-038

Price Code: A

A55485 / 02-013N

M38527 / 02-013N

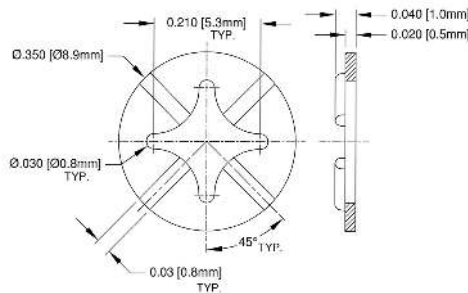

518-038

Price Code: A

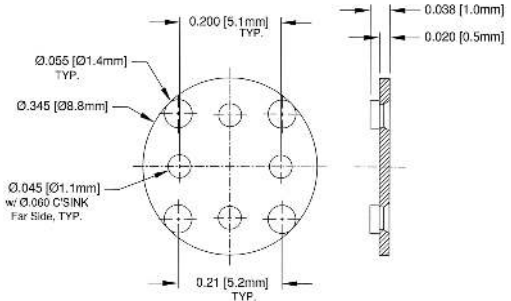

520-021

Price Code: A

A55485 / 02-019N

M38527 / 02-019N

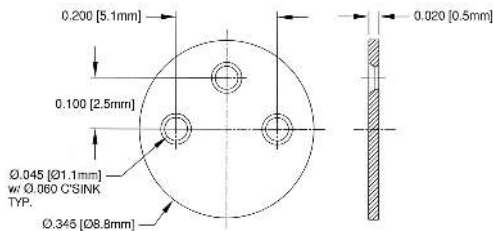

525-038

Price Code: A

A55485 / 02-014N

M38527 / 02-014N

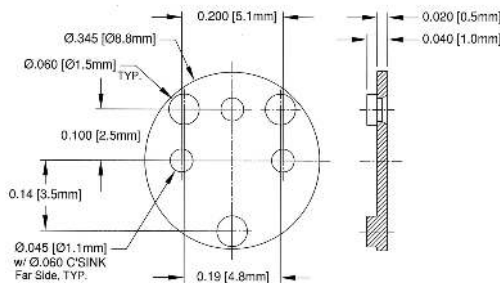

526-090

Price Code: A

A55485 / 02-038N

M38527 / 02-038N

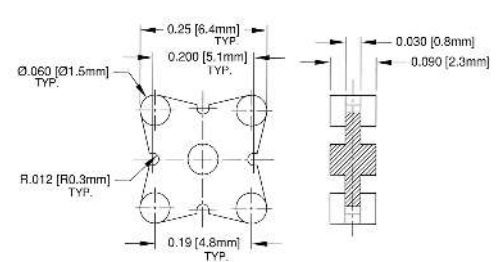

532-050

Price Code: A

