

# BGU8007

## SiGe:C Low Noise Amplifier MMIC for GPS, GLONASS, Galileo and Compass

Rev. 2 — 30 March 2012

Product data sheet

## 1. Product profile

### 1.1 General description

The BGU8007 is a Low Noise Amplifier (LNA) for GNSS receiver applications in a plastic leadless 6-pin, extremely small SOT886 package. The BGU8007 requires only one external matching inductor and one external decoupling capacitor.

The BGU8007 adapts itself to the changing environment resulting from co-habitation of different radio systems in modern cellular handsets. It has been designed for low power consumption and optimal performance when jamming signals from co-existing cellular transmitters are present. At low jamming power levels it delivers 19 dB gain at a noise figure of 0.75 dB. During high jamming power levels, resulting for example from a cellular transmit burst, it temporarily increases its bias current to improve sensitivity.

#### CAUTION



This device is sensitive to ElectroStatic Discharge (ESD). Therefore care should be taken during transport and handling.

### 1.2 Features and benefits

- Covers full GNSS L1 band, from 1559 MHz to 1610 MHz
- Noise figure (NF) = 0.75 dB
- Excellent low NF < 1 dB in the presence of strong jamming signals
- Gain 19 dB
- High input 1 dB compression point  $P_{i(1dB)}$  of -11 dBm
- High out of band  $IP3_i$  of 4 dBm
- Supply voltage 1.5 V to 2.5 V
- Power-down mode current consumption < 1  $\mu$ A
- Optimized performance at low supply current of 4.6 mA
- Integrated temperature stabilized bias for easy design
- Requires only one input matching inductor and one supply decoupling capacitor
- Input and output DC decoupled
- ESD protection on all pins (HBM > 2 kV)
- Integrated matching for the output
- Small 6-pin leadless package 1 mm  $\times$  1.45 mm  $\times$  0.5 mm
- 110 GHz transit frequency - SiGe:C technology



### 1.3 Applications

- LNA for GPS, GLONASS, Galileo and Compass (BeiDou) in smart phones, feature phones, tablet PCs, Personal Navigation Devices, Digital Still Cameras, Digital Video Cameras, RF Front End modules, complete GPS chipset modules and theft protection (laptop, ATM)

### 1.4 Quick reference data

**Table 1. Quick reference data**

$f = 1559\text{ MHz to }1610\text{ MHz}$ ;  $V_{CC} = 1.8\text{ V}$ ;  $P_i < -40\text{ dBm}$ ;  $T_{amb} = 25\text{ }^\circ\text{C}$ ; input matched to  $50\ \Omega$  using a  $5.6\text{ nH}$  inductor; unless otherwise specified.

Symbol	Parameter	Conditions	Min	Typ	Max	Unit
$V_{CC}$	supply voltage	RF input AC coupled	1.5	-	2.5	V
$I_{CC}$	supply current	$V_{ENABLE} \geq 0.8\text{ V}$				
		$P_i < -40\text{ dBm}$	3.3	4.6	5.9	mA
		$P_i = -20\text{ dBm}$	8.4	11.9	14.7	mA
$G_p$	power gain	$P_i < -40\text{ dBm}$ , no jammer	17.0	19.0	20.5	dB
		$P_i = -20\text{ dBm}$ , no jammer	18.5	20.5	21.5	dB
NF	noise figure	$P_i < -40\text{ dBm}$ , no jammer [1]	-	0.75	1.1	dB
		$P_i < -40\text{ dBm}$ , no jammer [2]	-	0.80	1.2	dB
		$P_i = -20\text{ dBm}$ , no jammer [2]	-	1.0	1.4	dB
$P_{i(1dB)}$	input power at 1 dB gain compression	$f = 1559\text{ MHz to }1610\text{ MHz}$				
		$V_{CC} = 1.5\text{ V}$	-15	-12	-	dBm
		$V_{CC} = 1.8\text{ V}$	-14	-11	-	dBm
		$V_{CC} = 2.2\text{ V}$	-13	-10	-	dBm
$IP3_i$	input third-order intercept point	$f = 1.575\text{ GHz}$				
		$V_{CC} = 1.5\text{ V}$	[3]	1	4	dBm
		$V_{CC} = 1.8\text{ V}$	[3]	1	4	dBm
		$V_{CC} = 2.2\text{ V}$	[3]	2	5	dBm

[1] PCB losses are subtracted.

[2] Including PCB losses.

[3]  $f_1 = 1713\text{ MHz}$ ;  $f_2 = 1851\text{ MHz}$ ;  $P_1 = P_2 = -30\text{ dBm}$ .

## 2. Pinning information

**Table 2. Pinning**

Pin	Description	Simplified outline	Graphic symbol
1	GND	<p>Transparent top view</p>	<p>sym129</p>
2	GND		
3	RF_IN		
4	$V_{CC}$		
5	ENABLE		
6	RF_OUT		

### 3. Ordering information

Table 3. Ordering information

Type number	Package		Version
	Name	Description	
BGU8007	XSON6	plastic extremely thin small outline package; no leads; 6 terminals; body 1 × 1.45 × 0.5 mm	SOT886

### 4. Marking

Table 4. Marking codes

Type number	Marking code
BGU8007	UZ

### 5. Limiting values

Table 5. Limiting values

In accordance with the Absolute Maximum Rating System (IEC 60134).

Symbol	Parameter	Conditions	Min	Max	Unit	
$V_{CC}$	supply voltage	RF input AC coupled	-0.5	+4.0	V	
$V_{ENABLE}$	voltage on pin ENABLE	$V_{ENABLE} < V_{CC} + 0.6$	[2]	-0.5	+4.0	V
$V_{RF\_IN}$	voltage on pin RF_IN	DC; $V_{RF\_IN} < V_{CC} + 0.6$	[2][3]	-0.5	+4.0	V
$V_{RF\_OUT}$	voltage on pin RF_OUT	DC; $V_{RF\_OUT} < V_{CC} + 0.6$	[2][3]	-0.5	+4.0	V
$P_i$	input power		-	0	dBm	
$P_{tot}$	total power dissipation	$T_{sp} \leq 130$ °C	[1]	55	mW	
$T_{stg}$	storage temperature		-65	+150	°C	
$T_j$	junction temperature		-	150	°C	
$V_{ESD}$	electrostatic discharge voltage	Human Body Model (HBM); According JEDEC standard 22-A114E	-	2	kV	
		Charged Device Model (CDM); According JEDEC standard 22-C101B	-	1	kV	

[1]  $T_{sp}$  is the temperature at the soldering point of the emitter lead.

[2] Warning: due to internal ESD diode protection, the applied DC voltage should not exceed  $V_{CC} + 0.6$  and shall not exceed 5.0 V in order to avoid excess current.

[3] The RF input and RF output are AC coupled through internal DC blocking capacitors.

### 6. Thermal characteristics

Table 6. Thermal characteristics

Symbol	Parameter	Conditions	Typ	Unit
$R_{th(j-sp)}$	thermal resistance from junction to solder point		225	K/W

## 7. Characteristics

**Table 7. Characteristics**

$f = 1559 \text{ MHz to } 1610 \text{ MHz}$ ;  $V_{CC} = 1.8 \text{ V}$ ;  $V_{ENABLE} \geq 0.8 \text{ V}$ ;  $P_i < -40 \text{ dBm}$ ;  $T_{amb} = 25 \text{ }^\circ\text{C}$ ; input matched to  $50 \text{ } \Omega$  using a  $5.6 \text{ nH}$  inductor; unless otherwise specified.

Symbol	Parameter	Conditions	Min	Typ	Max	Unit	
$V_{CC}$	supply voltage	RF input AC coupled	1.5	-	2.5	V	
$I_{CC}$	supply current	$V_{ENABLE} \geq 0.8 \text{ V}$					
		$P_i < -40 \text{ dBm}$	3.3	4.6	5.9	mA	
		$P_i = -20 \text{ dBm}$	8.4	11.9	14.7	mA	
		$V_{ENABLE} \leq 0.3 \text{ V}$	-	-	1	$\mu\text{A}$	
$T_{amb}$	ambient temperature		-40	+25	+85	$^\circ\text{C}$	
$G_p$	power gain	$T_{amb} = 25 \text{ }^\circ\text{C}$					
		$P_i < -40 \text{ dBm}$ , no jammer	17.0	19.0	20.5	dB	
		$P_i = -20 \text{ dBm}$ , no jammer	18.5	20.5	21.5	dB	
		$P_{jam} = -20 \text{ dBm}$ ; $f_{jam} = 850 \text{ MHz}$	18.5	20.5	21.5	dB	
		$P_{jam} = -20 \text{ dBm}$ ; $f_{jam} = 1850 \text{ MHz}$	18.5	20.5	21.5	dB	
		$-40 \text{ }^\circ\text{C} \leq T_{amb} \leq +85 \text{ }^\circ\text{C}$					
		$P_i < -40 \text{ dBm}$ , no jammer	16	-	21	dB	
		$P_i = -20 \text{ dBm}$ , no jammer	17	-	22	dB	
		$P_{jam} = -20 \text{ dBm}$ ; $f_{jam} = 850 \text{ MHz}$	17	-	22	dB	
		$P_{jam} = -20 \text{ dBm}$ ; $f_{jam} = 1850 \text{ MHz}$	17	-	22	dB	
$RL_{in}$	input return loss	$P_i < -40 \text{ dBm}$	4	5.5	-	dB	
		$P_i = -20 \text{ dBm}$	6	9	-	dB	
$RL_{out}$	output return loss	$P_i < -40 \text{ dBm}$	15	26	-	dB	
		$P_i = -20 \text{ dBm}$	15	27	-	dB	
ISL	isolation		22	24	-	dB	
NF	noise figure	$T_{amb} = 25 \text{ }^\circ\text{C}$					
		$P_i < -40 \text{ dBm}$ , no jammer	[1]	-	0.75	1.1	dB
		$P_i < -40 \text{ dBm}$ , no jammer	[2]	-	0.80	1.2	dB
		$P_i = -20 \text{ dBm}$ , no jammer	[2]	-	1.0	1.4	dB
		$P_{jam} = -20 \text{ dBm}$ ; $f_{jam} = 850 \text{ MHz}$	[2]	-	0.8	1.2	dB
		$P_{jam} = -20 \text{ dBm}$ ; $f_{jam} = 1850 \text{ MHz}$	[2]	-	1.1	1.5	dB
		$-40 \text{ }^\circ\text{C} \leq T_{amb} \leq +85 \text{ }^\circ\text{C}$					
		$P_i < -40 \text{ dBm}$ , no jammer	[2]	-	-	1.5	dB
		$P_i = -20 \text{ dBm}$ , no jammer	[2]	-	-	1.7	dB
		$P_{jam} = -20 \text{ dBm}$ ; $f_{jam} = 850 \text{ MHz}$	[2]	-	-	1.5	dB
		$P_{jam} = -20 \text{ dBm}$ ; $f_{jam} = 1850 \text{ MHz}$	[2]	-	-	1.8	dB

**Table 7. Characteristics ...continued**

$f = 1559 \text{ MHz to } 1610 \text{ MHz}$ ;  $V_{CC} = 1.8 \text{ V}$ ;  $V_{ENABLE} \geq 0.8 \text{ V}$ ;  $P_i < -40 \text{ dBm}$ ;  $T_{amb} = 25 \text{ }^\circ\text{C}$ ; input matched to  $50 \text{ } \Omega$  using a  $5.6 \text{ nH}$  inductor; unless otherwise specified.

Symbol	Parameter	Conditions	Min	Typ	Max	Unit	
$P_{i(1dB)}$	input power at 1 dB gain compression	$f = 1559 \text{ MHz to } 1610 \text{ MHz}$					
		$V_{CC} = 1.5 \text{ V}$	-15	-12	-	dBm	
		$V_{CC} = 1.8 \text{ V}$	-14	-11	-	dBm	
		$V_{CC} = 2.2 \text{ V}$	-13	-10	-	dBm	
		$f = 806 \text{ MHz to } 928 \text{ MHz}$					
		$V_{CC} = 1.5 \text{ V}$	[3]	-13	-10	-	dBm
		$V_{CC} = 1.8 \text{ V}$	[3]	-13	-10	-	dBm
		$V_{CC} = 2.2 \text{ V}$	[3]	-12	-9	-	dBm
		$f = 1612 \text{ MHz to } 1909 \text{ MHz}$					
		$V_{CC} = 1.5 \text{ V}$	[3]	-12	-9	-	dBm
		$V_{CC} = 1.8 \text{ V}$	[3]	-11	-8	-	dBm
		$V_{CC} = 2.2 \text{ V}$	[3]	-10	-7	-	dBm
$IP3_i$	input third-order intercept point	$f = 1.575 \text{ GHz}$					
		$V_{CC} = 1.5 \text{ V}$	[4]	1	4	-	dBm
		$V_{CC} = 1.8 \text{ V}$	[4]	1	4	-	dBm
		$V_{CC} = 2.2 \text{ V}$	[4]	2	5	-	dBm
$t_{on}$	turn-on time		[5]	-	-	2	$\mu\text{s}$
$t_{off}$	turn-off time		[5]	-	-	1	$\mu\text{s}$

- [1] PCB losses are subtracted.
- [2] Including PCB losses.
- [3] Out of band.
- [4]  $f_1 = 1713 \text{ MHz}$ ;  $f_2 = 1851 \text{ MHz}$ ;  $P_1 = P_2 = -30 \text{ dBm}$ .
- [5] Within 10 % of the final gain.

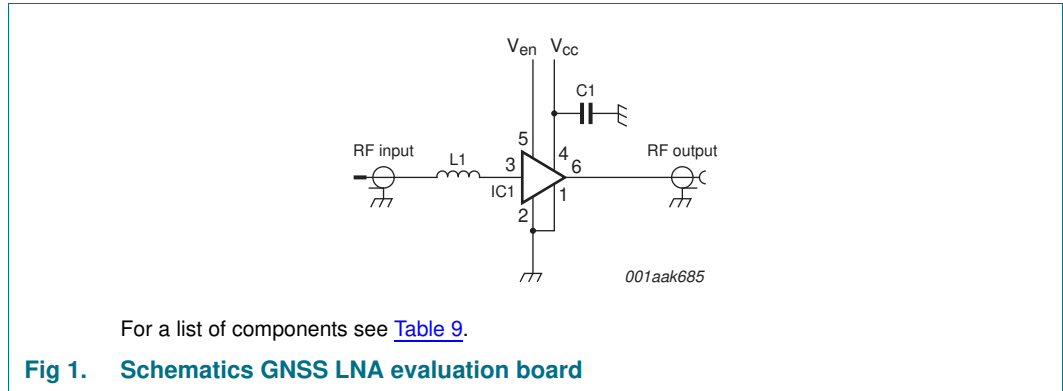
**Table 8. ENABLE (pin 5)**

$-40 \text{ }^\circ\text{C} \leq T_{amb} \leq +85 \text{ }^\circ\text{C}$ ;  $1.5 \text{ V} \leq V_{CC} \leq 2.5 \text{ V}$

$V_{ENABLE} \text{ (V)}$	State
$\leq 0.3$	OFF
$\geq 0.8$	ON

## 8. Application information

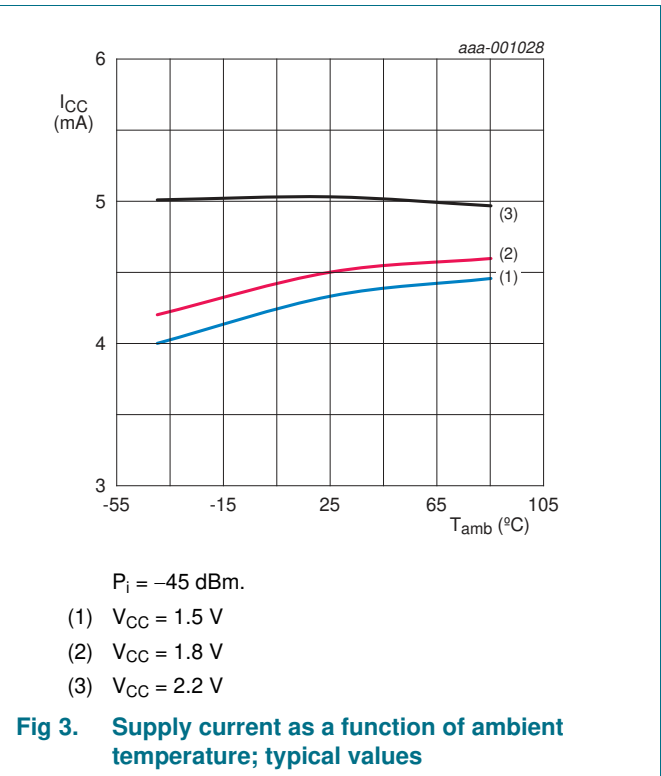
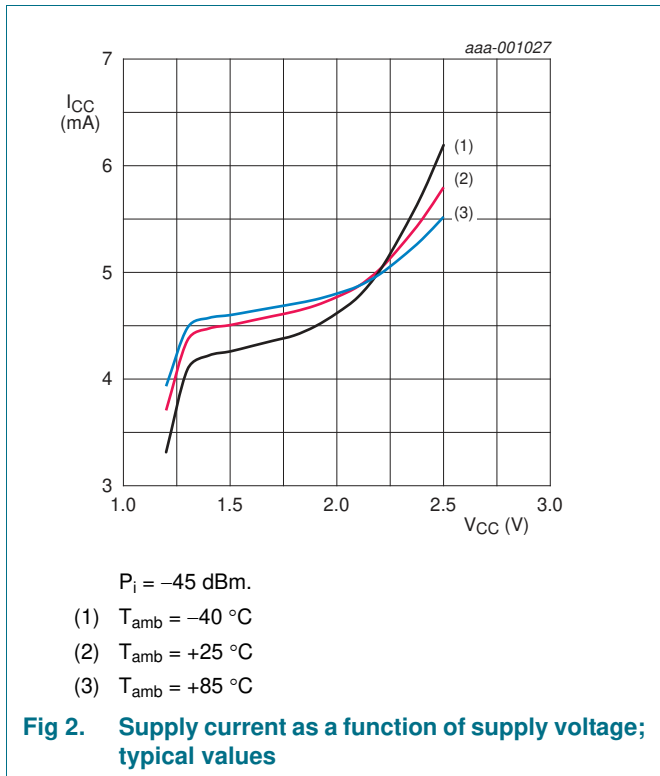
### 8.1 GNSS LNA

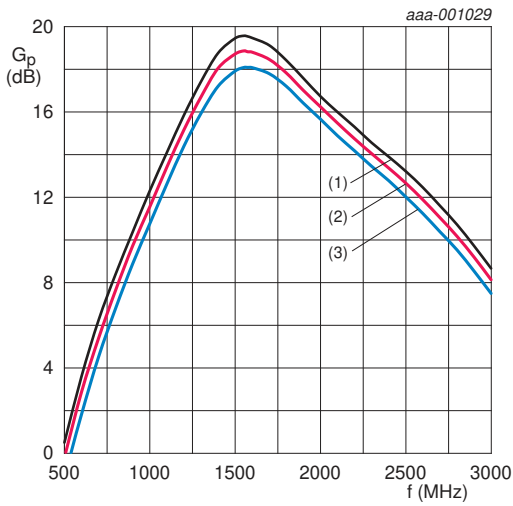


**Table 9. List of components**

For schematics see [Figure 1](#).

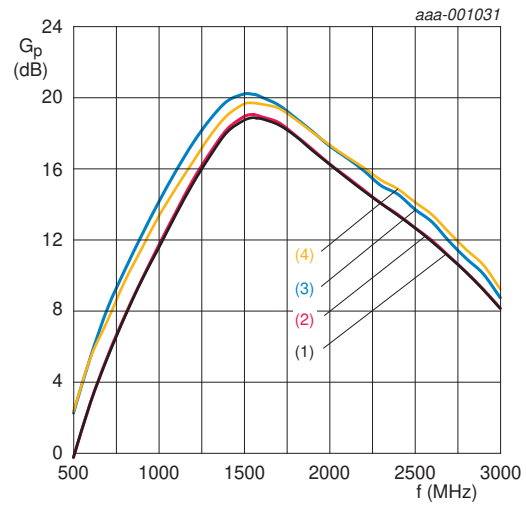
Component	Description	Value	Supplier	Remarks
C1	decoupling capacitor	1 nF	various	
IC1	BGU8007	-	NXP	
L1	high quality matching inductor	5.6 nH	Murata LQW15A	





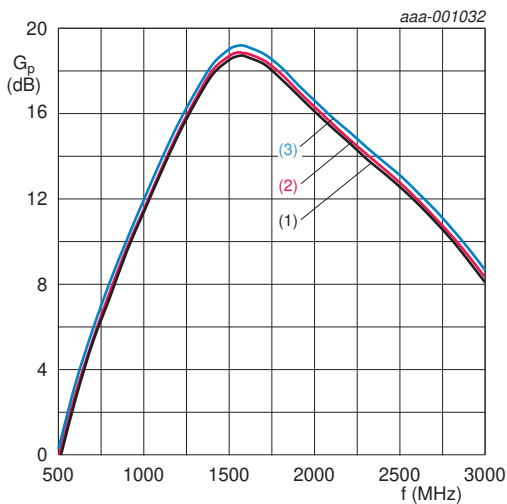
$V_{CC} = 1.8\text{ V}; P_i = -45\text{ dBm}.$   
 (1)  $T_{amb} = -40\text{ }^\circ\text{C}$   
 (2)  $T_{amb} = +25\text{ }^\circ\text{C}$   
 (3)  $T_{amb} = +85\text{ }^\circ\text{C}$

**Fig 4. Power gain as a function of frequency; typical values**



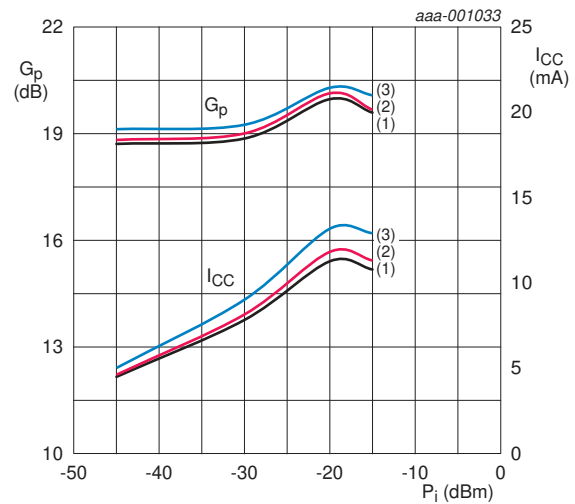
$V_{CC} = 1.8\text{ V}; T_{amb} = 25\text{ }^\circ\text{C}.$   
 (1)  $P_i = -45\text{ dBm}$   
 (2)  $P_i = -30\text{ dBm}$   
 (3)  $P_i = -20\text{ dBm}$   
 (4)  $P_i = -15\text{ dBm}$

**Fig 5. Power gain as a function of frequency; typical values**



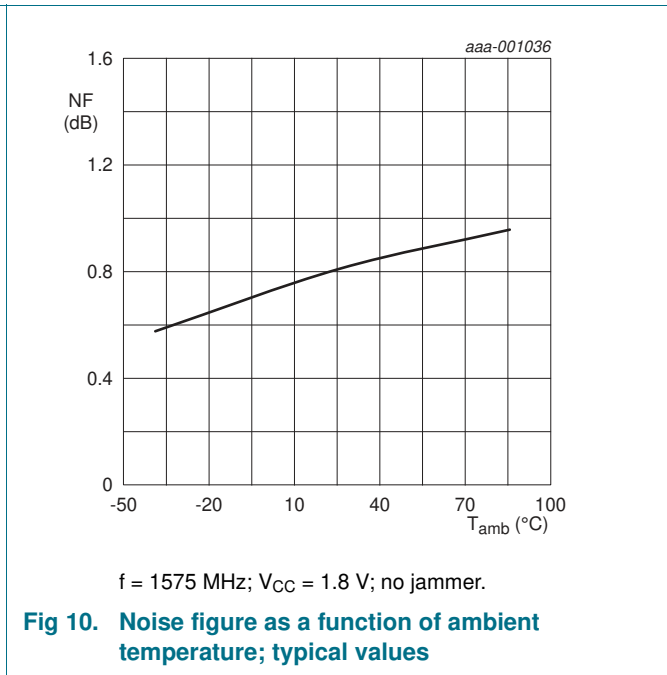
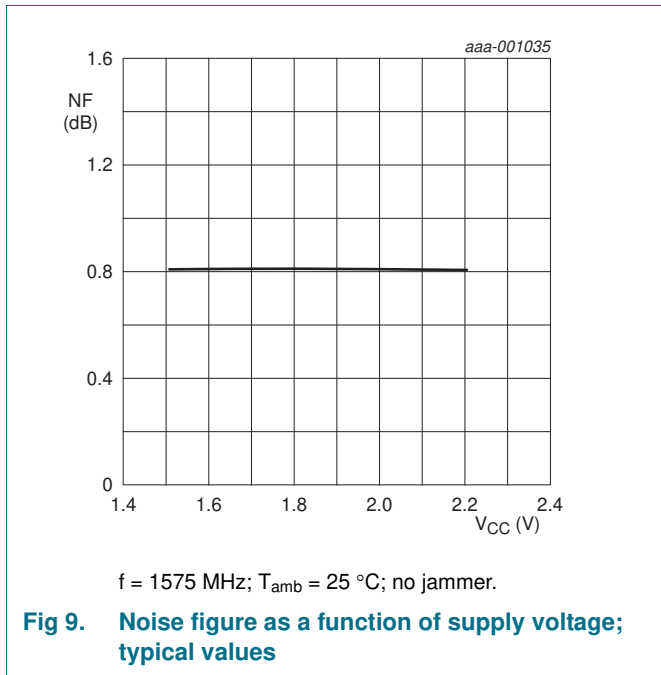
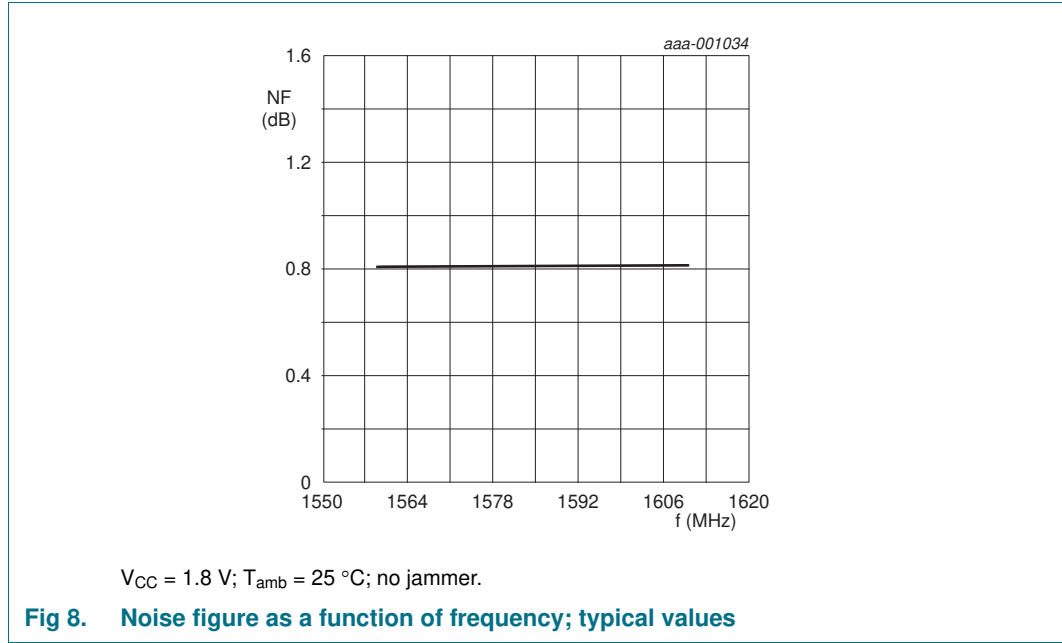
$P_i = -45\text{ dBm}; T_{amb} = 25\text{ }^\circ\text{C}.$   
 (1)  $V_{CC} = 1.5\text{ V}$   
 (2)  $V_{CC} = 1.8\text{ V}$   
 (3)  $V_{CC} = 2.2\text{ V}$

**Fig 6. Power gain as a function of frequency; typical values**

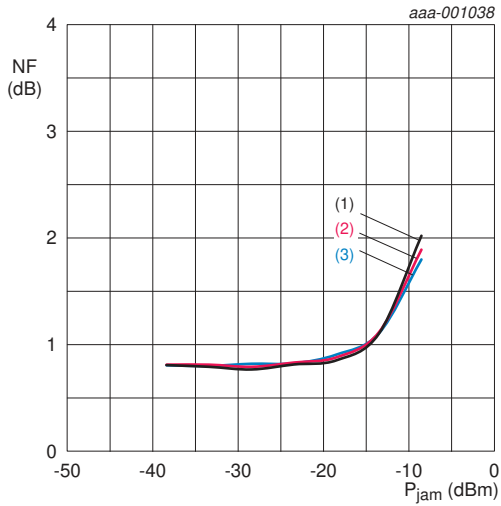


$T_{amb} = 25\text{ }^\circ\text{C}; f = 1575\text{ MHz}.$   
 (1)  $V_{CC} = 1.5\text{ V}$   
 (2)  $V_{CC} = 1.8\text{ V}$   
 (3)  $V_{CC} = 2.2\text{ V}$

**Fig 7. Power gain as a function of input power; typical values**

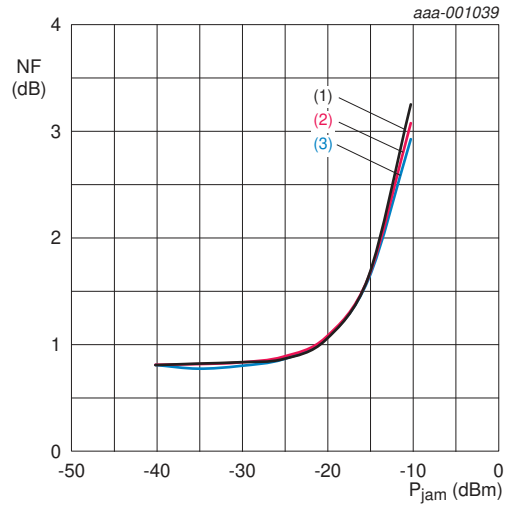






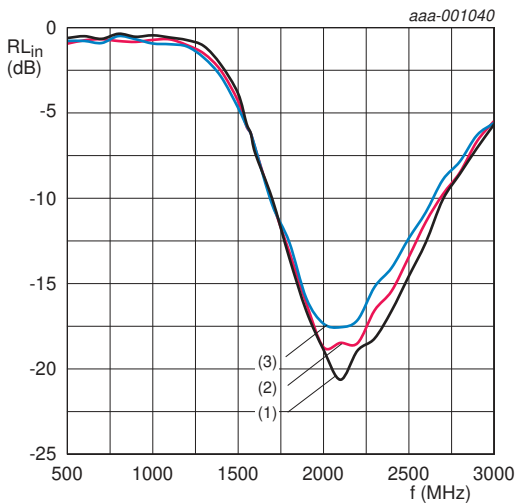
$f_{jam} = 850 \text{ MHz}; T_{amb} = 25 \text{ }^\circ\text{C}; f = 1575 \text{ MHz.}$   
 (1)  $V_{CC} = 1.5 \text{ V}$   
 (2)  $V_{CC} = 1.8 \text{ V}$   
 (3)  $V_{CC} = 2.2 \text{ V}$

**Fig 11. Noise figure as a function of jamming power; typical values**



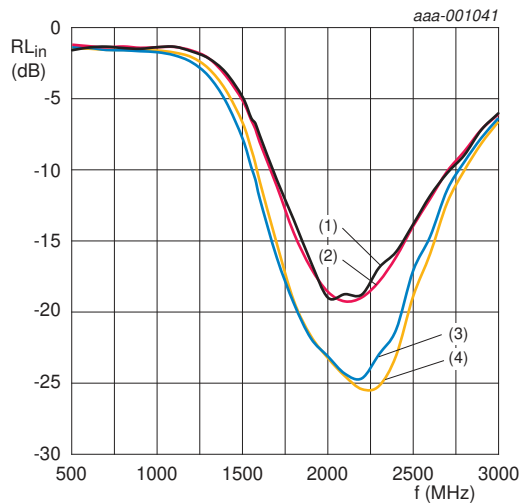
$f_{jam} = 1850 \text{ MHz}; T_{amb} = 25 \text{ }^\circ\text{C}; f = 1575 \text{ MHz.}$   
 (1)  $V_{CC} = 1.5 \text{ V}$   
 (2)  $V_{CC} = 1.8 \text{ V}$   
 (3)  $V_{CC} = 2.2 \text{ V}$

**Fig 12. Noise figure as a function of jamming power; typical values**



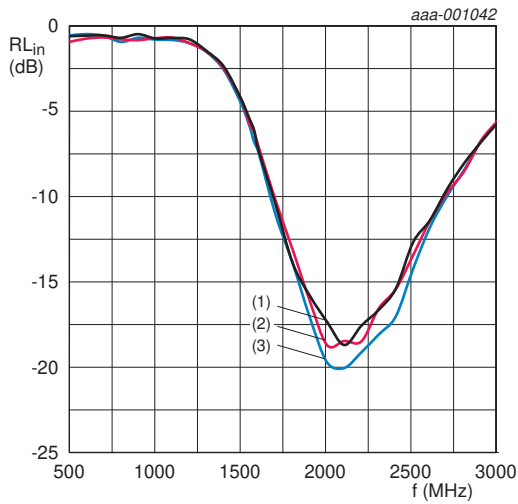
$V_{CC} = 1.8 \text{ V}; P_i = -45 \text{ dBm.}$   
 (1)  $T_{amb} = -40 \text{ }^\circ\text{C}$   
 (2)  $T_{amb} = +25 \text{ }^\circ\text{C}$   
 (3)  $T_{amb} = +85 \text{ }^\circ\text{C}$

**Fig 13. Input return loss as a function of frequency; typical values**



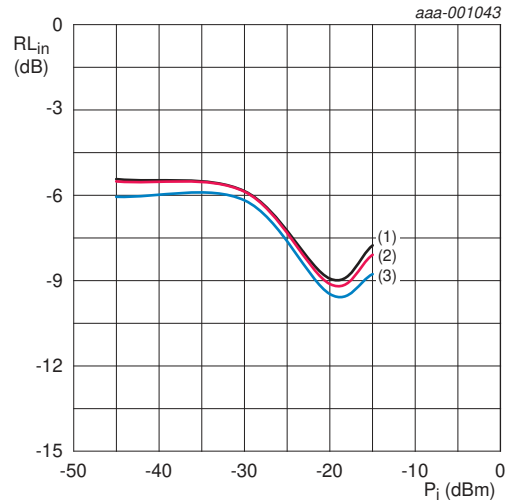
$V_{CC} = 1.8 \text{ V}; T_{amb} = 25 \text{ }^\circ\text{C.}$   
 (1)  $P_i = -45 \text{ dBm}$   
 (2)  $P_i = -30 \text{ dBm}$   
 (3)  $P_i = -20 \text{ dBm}$   
 (4)  $P_i = -15 \text{ dBm}$

**Fig 14. Input return loss as a function of frequency; typical values**



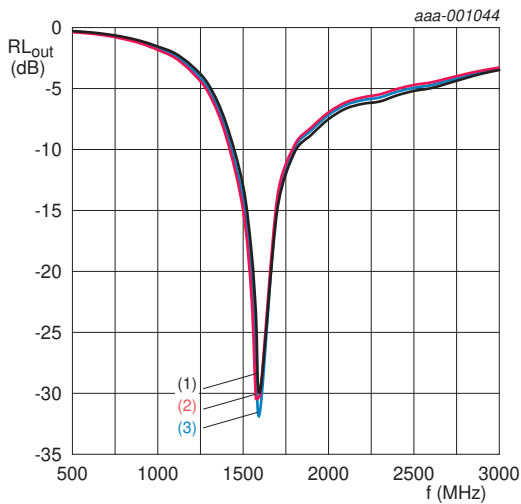
$P_i = -45 \text{ dBm}$ ;  $T_{\text{amb}} = 25 \text{ }^\circ\text{C}$ .  
 (1)  $V_{\text{CC}} = 1.5 \text{ V}$   
 (2)  $V_{\text{CC}} = 1.8 \text{ V}$   
 (3)  $V_{\text{CC}} = 2.2 \text{ V}$

**Fig 15. Input return loss as a function of frequency; typical values**



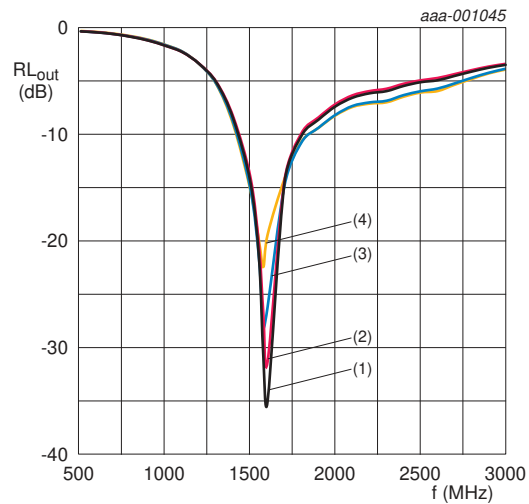
$T_{\text{amb}} = 25 \text{ }^\circ\text{C}$ ;  $f = 1575 \text{ MHz}$ .  
 (1)  $V_{\text{CC}} = 1.5 \text{ V}$   
 (2)  $V_{\text{CC}} = 1.8 \text{ V}$   
 (3)  $V_{\text{CC}} = 2.2 \text{ V}$

**Fig 16. Input return loss as a function of input power; typical values**



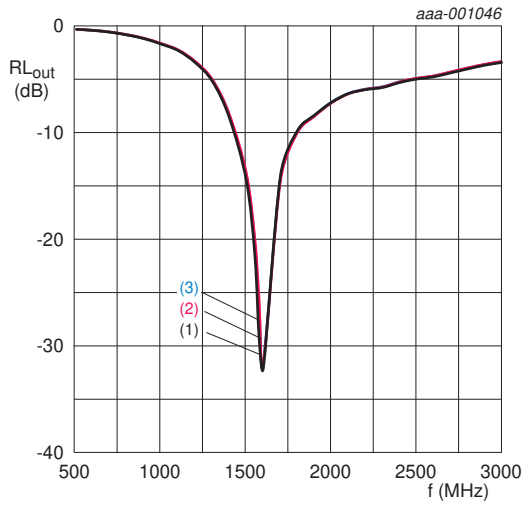
$V_{\text{CC}} = 1.8 \text{ V}$ ;  $P_i = -45 \text{ dBm}$ .  
 (1)  $T_{\text{amb}} = -40 \text{ }^\circ\text{C}$   
 (2)  $T_{\text{amb}} = +25 \text{ }^\circ\text{C}$   
 (3)  $T_{\text{amb}} = +85 \text{ }^\circ\text{C}$

**Fig 17. Output return loss as a function of frequency; typical values**



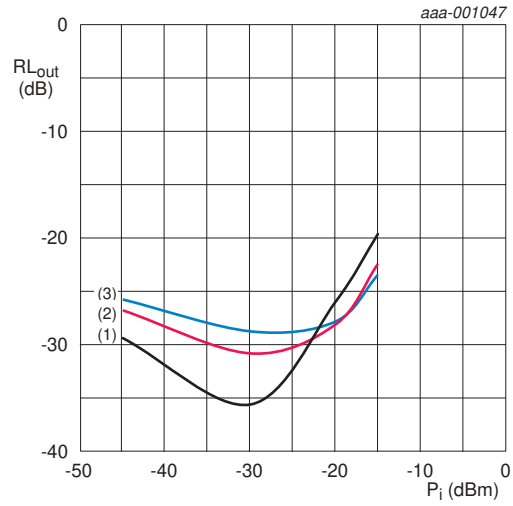
$V_{\text{CC}} = 1.8 \text{ V}$ ;  $T_{\text{amb}} = 25 \text{ }^\circ\text{C}$ .  
 (1)  $P_i = -45 \text{ dBm}$   
 (2)  $P_i = -30 \text{ dBm}$   
 (3)  $P_i = -20 \text{ dBm}$   
 (4)  $P_i = -15 \text{ dBm}$

**Fig 18. Output return loss as a function of frequency; typical values**



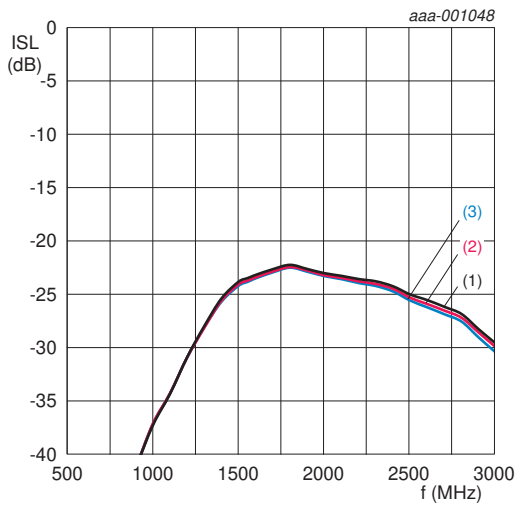
$P_i = -45 \text{ dBm}$ ;  $T_{\text{amb}} = 25 \text{ }^\circ\text{C}$ .  
 (1)  $V_{\text{CC}} = 1.5 \text{ V}$   
 (2)  $V_{\text{CC}} = 1.8 \text{ V}$   
 (3)  $V_{\text{CC}} = 2.2 \text{ V}$

**Fig 19. Output return loss as a function of frequency; typical values**



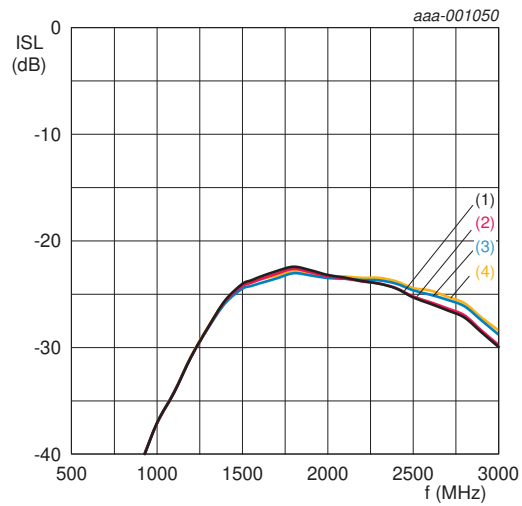
$T_{\text{amb}} = 25 \text{ }^\circ\text{C}$ ;  $f = 1575 \text{ MHz}$ .  
 (1)  $V_{\text{CC}} = 1.5 \text{ V}$   
 (2)  $V_{\text{CC}} = 1.8 \text{ V}$   
 (3)  $V_{\text{CC}} = 2.2 \text{ V}$

**Fig 20. Output return loss as a function of input power; typical values**



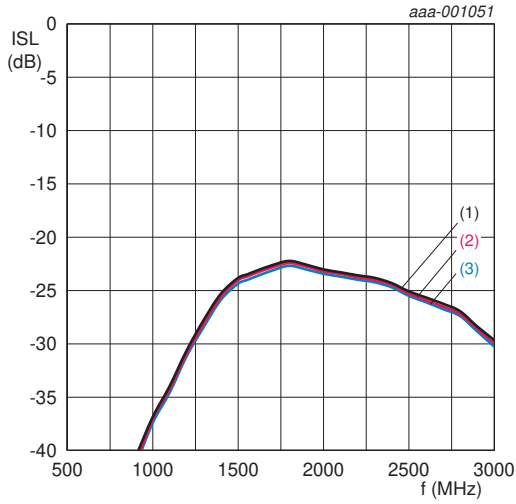
$V_{\text{CC}} = 1.8 \text{ V}$ ;  $P_i = -45 \text{ dBm}$ .  
 (1)  $T_{\text{amb}} = -40 \text{ }^\circ\text{C}$   
 (2)  $T_{\text{amb}} = +25 \text{ }^\circ\text{C}$   
 (3)  $T_{\text{amb}} = +85 \text{ }^\circ\text{C}$

**Fig 21. Isolation as a function of frequency; typical values**



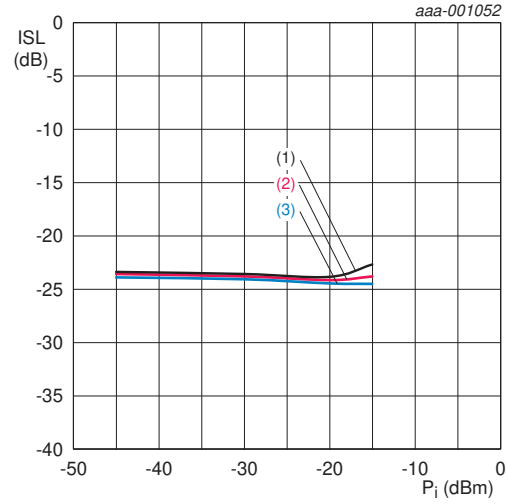
$V_{\text{CC}} = 1.8 \text{ V}$ ;  $T_{\text{amb}} = 25 \text{ }^\circ\text{C}$ .  
 (1)  $P_i = -45 \text{ dBm}$   
 (2)  $P_i = -30 \text{ dBm}$   
 (3)  $P_i = -20 \text{ dBm}$   
 (4)  $P_i = -15 \text{ dBm}$

**Fig 22. Isolation as a function of frequency; typical values**



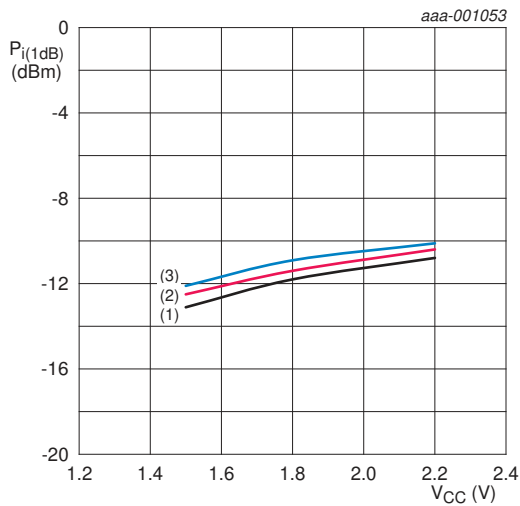
$P_i = -45 \text{ dBm}$ ;  $T_{\text{amb}} = 25 \text{ }^\circ\text{C}$ .  
 (1)  $V_{\text{CC}} = 1.5 \text{ V}$   
 (2)  $V_{\text{CC}} = 1.8 \text{ V}$   
 (3)  $V_{\text{CC}} = 2.2 \text{ V}$

**Fig 23. Isolation as a function of frequency; typical values**



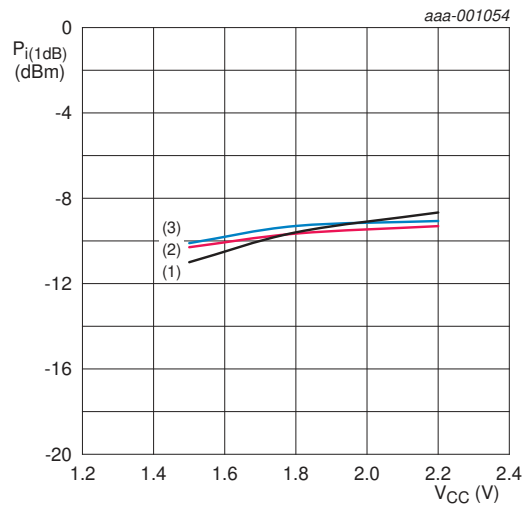
$T_{\text{amb}} = 25 \text{ }^\circ\text{C}$ ;  $f = 1575 \text{ MHz}$ .  
 (1)  $V_{\text{CC}} = 1.5 \text{ V}$   
 (2)  $V_{\text{CC}} = 1.8 \text{ V}$   
 (3)  $V_{\text{CC}} = 2.2 \text{ V}$

**Fig 24. Isolation as a function of input power; typical values**



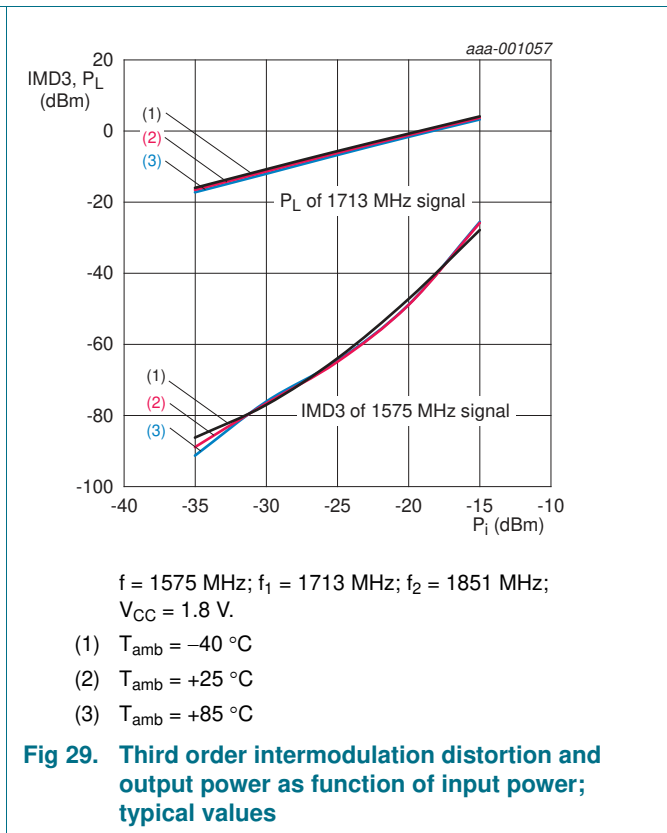
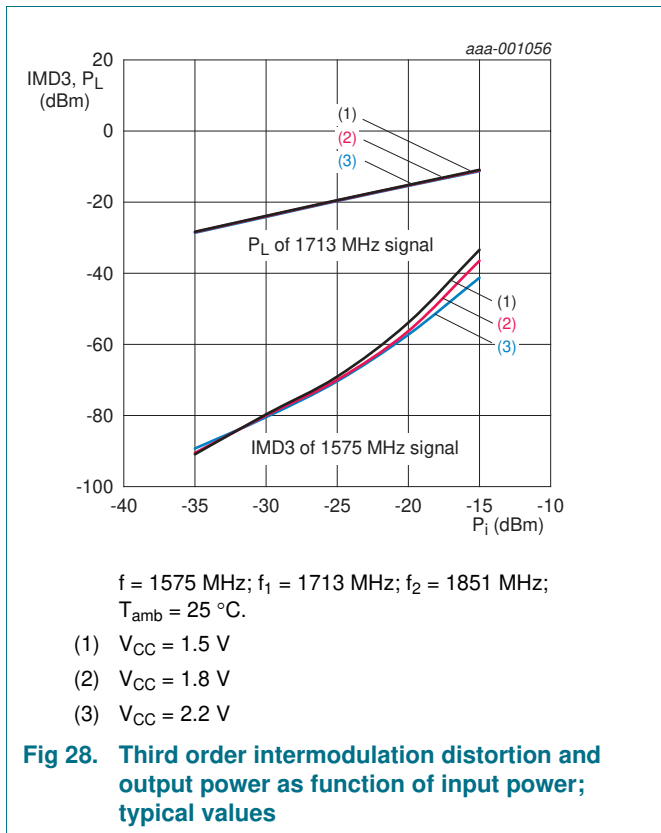
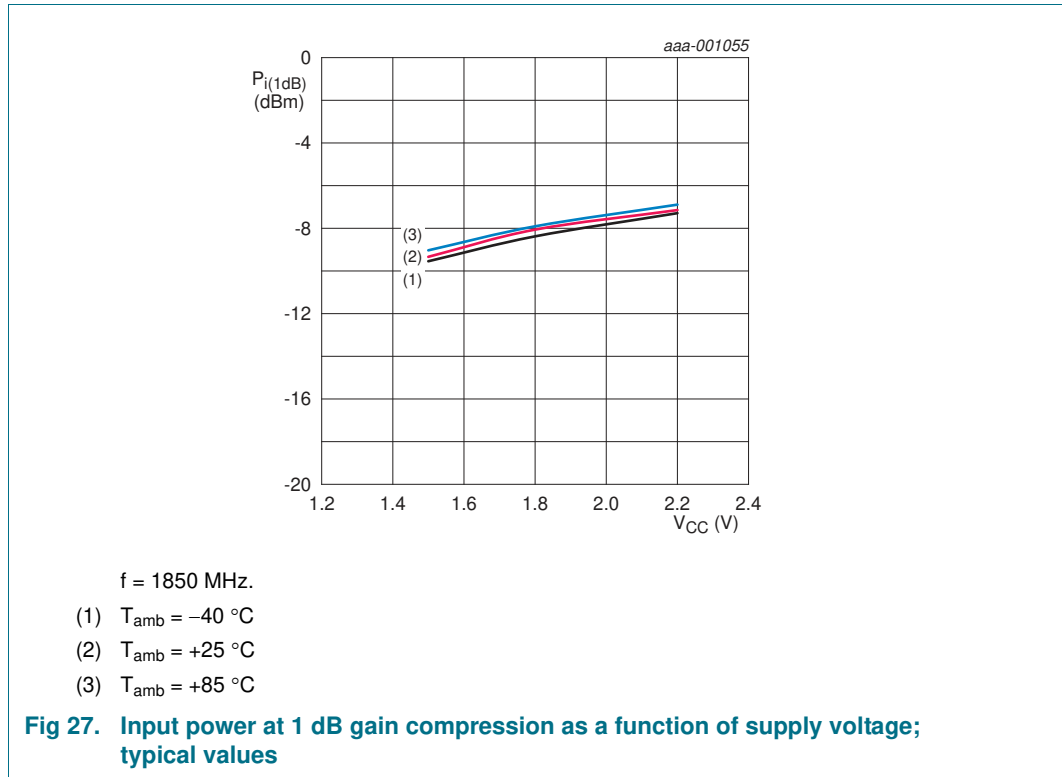
$f = 1575 \text{ MHz}$ .  
 (1)  $T_{\text{amb}} = -40 \text{ }^\circ\text{C}$   
 (2)  $T_{\text{amb}} = +25 \text{ }^\circ\text{C}$   
 (3)  $T_{\text{amb}} = +85 \text{ }^\circ\text{C}$

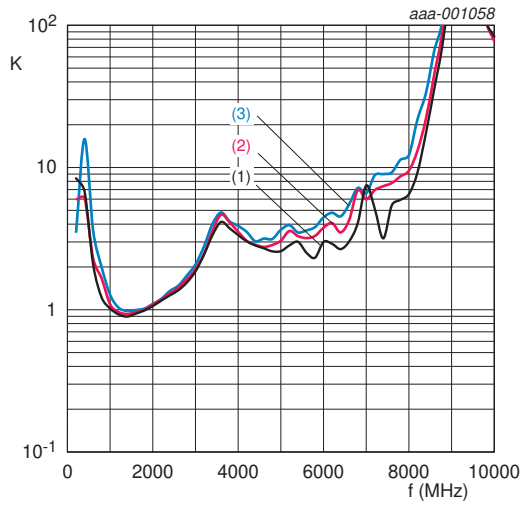
**Fig 25. Input power at 1 dB gain compression as a function of supply voltage; typical values**



$f = 850 \text{ MHz}$ .  
 (1)  $T_{\text{amb}} = -40 \text{ }^\circ\text{C}$   
 (2)  $T_{\text{amb}} = +25 \text{ }^\circ\text{C}$   
 (3)  $T_{\text{amb}} = +85 \text{ }^\circ\text{C}$

**Fig 26. Input power at 1 dB gain compression as a function of supply voltage; typical values**

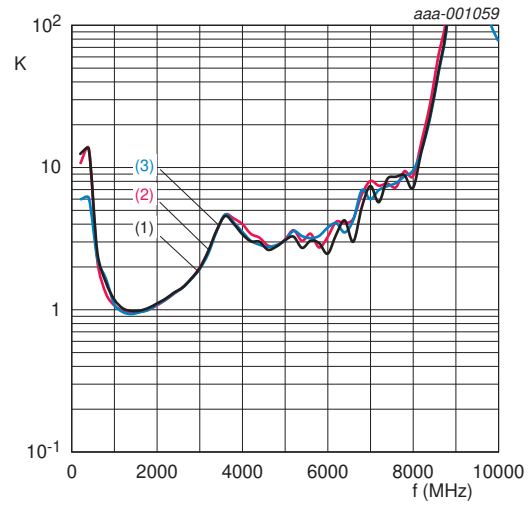




$V_{CC} = 1.8\text{ V}; P_i = -45\text{ dBm}.$

- (1)  $T_{amb} = -40\text{ }^\circ\text{C}$
- (2)  $T_{amb} = +25\text{ }^\circ\text{C}$
- (3)  $T_{amb} = +85\text{ }^\circ\text{C}$

**Fig 30. Rollett stability factor as a function of frequency; typical values**



$T_{amb} = 25\text{ }^\circ\text{C}; P_i = -45\text{ dBm}.$

- (1)  $V_{CC} = 1.5\text{ V}$
- (2)  $V_{CC} = 1.8\text{ V}$
- (3)  $V_{CC} = 2.2\text{ V}$

**Fig 31. Rollett stability factor as a function of frequency; typical values**

9. Package outline

XSON6: plastic extremely thin small outline package; no leads; 6 terminals; body 1 x 1.45 x 0.5 mm

SOT886

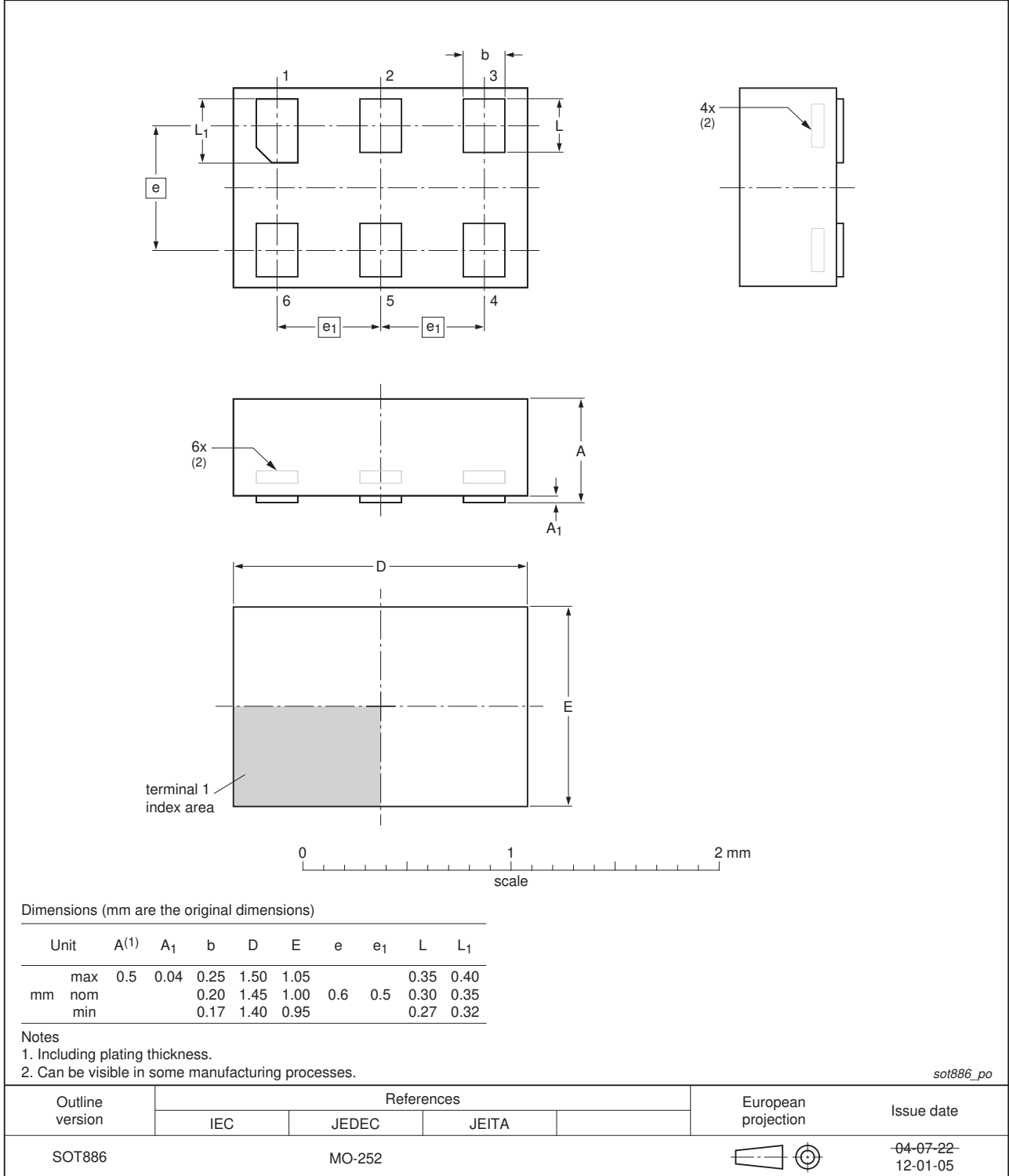


Fig 32. Package outline SOT886 (XSON6)

## 10. Abbreviations

**Table 10. Abbreviations**

Acronym	Description
AC	Alternating Current
ATM	Automated Teller Machine (cash dispenser)
DC	Direct Current
GLONASS	GLObal NAVigation Satellite System
GNSS	Global Navigation Satellite System
GPS	Global Positioning System
HBM	Human Body Model
MMIC	Monolithic Microwave Integrated Circuit
PC	Personal Computer
PCB	Printed Circuit Board
RF	Radio Frequency
SiGe:C	Silicon Germanium Carbon

## 11. Revision history

**Table 11. Revision history**

Document ID	Release date	Data sheet status	Change notice	Supersedes
BGU8007 v.2	20120330	Product data sheet	-	BGU8007 v.1
Modifications: <ul style="list-style-type: none"> <li>• Added 'Compass' to descriptive title</li> <li>• <a href="#">Section 1.3 on page 2</a>: added 'Compass' to text</li> <li>• <a href="#">Section 1.2 on page 1</a>: row 7, changed 2.2 V to 2.5 V</li> <li>• <a href="#">Table 1 on page 2</a>: changed max. value <math>V_{CC}</math> from 2.2 V to 2.5 V</li> <li>• <a href="#">Table 7 on page 4</a>: changed max. value <math>V_{CC}</math> from 2.2 V to 2.5 V</li> <li>• <a href="#">Table 8 on page 5</a>: changed max. value <math>V_{CC}</math> from 2.2 V to 2.5 V</li> <li>• <a href="#">Table 5 on page 3</a>: Several additions and changes</li> </ul>				
BGU8007 v.1	20111011	Product data sheet	-	-



## 12. Legal information

### 12.1 Data sheet status

Document status <sup>[1][2]</sup>	Product status <sup>[3]</sup>	Definition
Objective [short] data sheet	Development	This document contains data from the objective specification for product development.
Preliminary [short] data sheet	Qualification	This document contains data from the preliminary specification.
Product [short] data sheet	Production	This document contains the product specification.

[1] Please consult the most recently issued document before initiating or completing a design.

[2] The term 'short data sheet' is explained in section "Definitions".

[3] The product status of device(s) described in this document may have changed since this document was published and may differ in case of multiple devices. The latest product status information is available on the Internet at URL <http://www.nxp.com>.

### 12.2 Definitions

**Draft** — The document is a draft version only. The content is still under internal review and subject to formal approval, which may result in modifications or additions. NXP Semiconductors does not give any representations or warranties as to the accuracy or completeness of information included herein and shall have no liability for the consequences of use of such information.

**Short data sheet** — A short data sheet is an extract from a full data sheet with the same product type number(s) and title. A short data sheet is intended for quick reference only and should not be relied upon to contain detailed and full information. For detailed and full information see the relevant full data sheet, which is available on request via the local NXP Semiconductors sales office. In case of any inconsistency or conflict with the short data sheet, the full data sheet shall prevail.

**Product specification** — The information and data provided in a Product data sheet shall define the specification of the product as agreed between NXP Semiconductors and its customer, unless NXP Semiconductors and customer have explicitly agreed otherwise in writing. In no event however, shall an agreement be valid in which the NXP Semiconductors product is deemed to offer functions and qualities beyond those described in the Product data sheet.

### 12.3 Disclaimers

**Limited warranty and liability** — Information in this document is believed to be accurate and reliable. However, NXP Semiconductors does not give any representations or warranties, expressed or implied, as to the accuracy or completeness of such information and shall have no liability for the consequences of use of such information. NXP Semiconductors takes no responsibility for the content in this document if provided by an information source outside of NXP Semiconductors.

In no event shall NXP Semiconductors be liable for any indirect, incidental, punitive, special or consequential damages (including - without limitation - lost profits, lost savings, business interruption, costs related to the removal or replacement of any products or rework charges) whether or not such damages are based on tort (including negligence), warranty, breach of contract or any other legal theory.

Notwithstanding any damages that customer might incur for any reason whatsoever, NXP Semiconductors' aggregate and cumulative liability towards customer for the products described herein shall be limited in accordance with the *Terms and conditions of commercial sale* of NXP Semiconductors.

**Right to make changes** — NXP Semiconductors reserves the right to make changes to information published in this document, including without limitation specifications and product descriptions, at any time and without notice. This document supersedes and replaces all information supplied prior to the publication hereof.

**Suitability for use** — NXP Semiconductors products are not designed, authorized or warranted to be suitable for use in life support, life-critical or safety-critical systems or equipment, nor in applications where failure or malfunction of an NXP Semiconductors product can reasonably be expected to result in personal injury, death or severe property or environmental damage. NXP Semiconductors and its suppliers accept no liability for inclusion and/or use of NXP Semiconductors products in such equipment or applications and therefore such inclusion and/or use is at the customer's own risk.

**Applications** — Applications that are described herein for any of these products are for illustrative purposes only. NXP Semiconductors makes no representation or warranty that such applications will be suitable for the specified use without further testing or modification.

Customers are responsible for the design and operation of their applications and products using NXP Semiconductors products, and NXP Semiconductors accepts no liability for any assistance with applications or customer product design. It is customer's sole responsibility to determine whether the NXP Semiconductors product is suitable and fit for the customer's applications and products planned, as well as for the planned application and use of customer's third party customer(s). Customers should provide appropriate design and operating safeguards to minimize the risks associated with their applications and products.

NXP Semiconductors does not accept any liability related to any default, damage, costs or problem which is based on any weakness or default in the customer's applications or products, or the application or use by customer's third party customer(s). Customer is responsible for doing all necessary testing for the customer's applications and products using NXP Semiconductors products in order to avoid a default of the applications and the products or of the application or use by customer's third party customer(s). NXP does not accept any liability in this respect.

**Limiting values** — Stress above one or more limiting values (as defined in the Absolute Maximum Ratings System of IEC 60134) will cause permanent damage to the device. Limiting values are stress ratings only and (proper) operation of the device at these or any other conditions above those given in the Recommended operating conditions section (if present) or the Characteristics sections of this document is not warranted. Constant or repeated exposure to limiting values will permanently and irreversibly affect the quality and reliability of the device.

**Terms and conditions of commercial sale** — NXP Semiconductors products are sold subject to the general terms and conditions of commercial sale, as published at <http://www.nxp.com/profile/terms>, unless otherwise agreed in a valid written individual agreement. In case an individual agreement is concluded only the terms and conditions of the respective agreement shall apply. NXP Semiconductors hereby expressly objects to applying the customer's general terms and conditions with regard to the purchase of NXP Semiconductors products by customer.

**No offer to sell or license** — Nothing in this document may be interpreted or construed as an offer to sell products that is open for acceptance or the grant, conveyance or implication of any license under any copyrights, patents or other industrial or intellectual property rights.

**Export control** — This document as well as the item(s) described herein may be subject to export control regulations. Export might require a prior authorization from competent authorities.

**Non-automotive qualified products** — Unless this data sheet expressly states that this specific NXP Semiconductors product is automotive qualified, the product is not suitable for automotive use. It is neither qualified nor tested in accordance with automotive testing or application requirements. NXP Semiconductors accepts no liability for inclusion and/or use of non-automotive qualified products in automotive equipment or applications.

In the event that customer uses the product for design-in and use in automotive applications to automotive specifications and standards, customer (a) shall use the product without NXP Semiconductors' warranty of the product for such automotive applications, use and specifications, and (b) whenever customer uses the product for automotive applications beyond NXP Semiconductors' specifications such use shall be solely at customer's own risk, and (c) customer fully indemnifies NXP Semiconductors for any

liability, damages or failed product claims resulting from customer design and use of the product for automotive applications beyond NXP Semiconductors' standard warranty and NXP Semiconductors' product specifications.

**Quick reference data** — The Quick reference data is an extract of the product data given in the Limiting values and Characteristics sections of this document, and as such is not complete, exhaustive or legally binding.

**Translations** — A non-English (translated) version of a document is for reference only. The English version shall prevail in case of any discrepancy between the translated and English versions.

## 12.4 Trademarks

Notice: All referenced brands, product names, service names and trademarks are the property of their respective owners.

## 13. Contact information

---

For more information, please visit: <http://www.nxp.com>

For sales office addresses, please send an email to: [salesaddresses@nxp.com](mailto:salesaddresses@nxp.com)

## 14. Contents

---

<b>1</b>	<b>Product profile</b> . . . . .	<b>1</b>
1.1	General description . . . . .	1
1.2	Features and benefits . . . . .	1
1.3	Applications . . . . .	2
1.4	Quick reference data . . . . .	2
<b>2</b>	<b>Pinning information</b> . . . . .	<b>2</b>
<b>3</b>	<b>Ordering information</b> . . . . .	<b>3</b>
<b>4</b>	<b>Marking</b> . . . . .	<b>3</b>
<b>5</b>	<b>Limiting values</b> . . . . .	<b>3</b>
<b>6</b>	<b>Thermal characteristics</b> . . . . .	<b>3</b>
<b>7</b>	<b>Characteristics</b> . . . . .	<b>4</b>
<b>8</b>	<b>Application information</b> . . . . .	<b>6</b>
8.1	GNSS LNA . . . . .	6
<b>9</b>	<b>Package outline</b> . . . . .	<b>15</b>
<b>10</b>	<b>Abbreviations</b> . . . . .	<b>16</b>
<b>11</b>	<b>Revision history</b> . . . . .	<b>16</b>
<b>12</b>	<b>Legal information</b> . . . . .	<b>17</b>
12.1	Data sheet status . . . . .	17
12.2	Definitions . . . . .	17
12.3	Disclaimers . . . . .	17
12.4	Trademarks . . . . .	18
<b>13</b>	<b>Contact information</b> . . . . .	<b>18</b>
<b>14</b>	<b>Contents</b> . . . . .	<b>19</b>

---

Please be aware that important notices concerning this document and the product(s) described herein, have been included in section 'Legal information'.

© NXP B.V. 2012.

All rights reserved.

For more information, please visit: <http://www.nxp.com>

For sales office addresses, please send an email to: [salesaddresses@nxp.com](mailto:salesaddresses@nxp.com)

Date of release: 30 March 2012

Document identifier: BGU8007