

Click to
ORDER
samples

AM30SBO-NZ

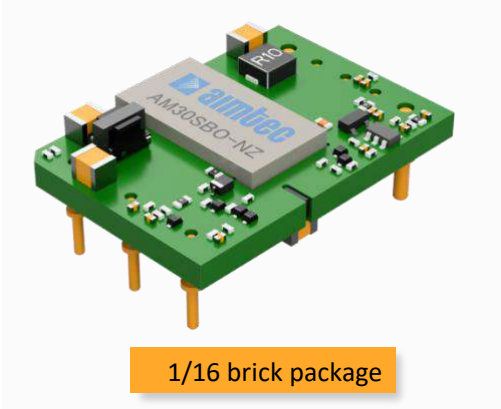

1/16 brick package

The AM30SBO-NZ series is a high-performance 1/16 brick DC/DC converter specifically designed for a variety of telecom applications. It features 30W of output power with no requirement for minimum load, a wide input voltage of 36-75VDC, operating temperature up to 85°C and tested I/O isolation of 1500VDC.

Additionally, this series features include input under-voltage protection, output over-voltage, short-circuit, over-current and over-temperature protection, remote On/Off control, remote sense compensation and output voltage trim adjustment.

The AM30SBO-NZ meets EN 62368 standards and are widely used in the industrial control, electric power instrumentation and communications.

Features



Summary



- High I/O Isolation 1500VDC
- Input under voltage protection, over temperature protection, output over voltage, over current and short circuit protection
- Operating Temp: -40 °C to +85 °C
- Low profile height: 9.18mm
- Compact 1/16 brick footprint and high-power density
- Efficiency up to 90%

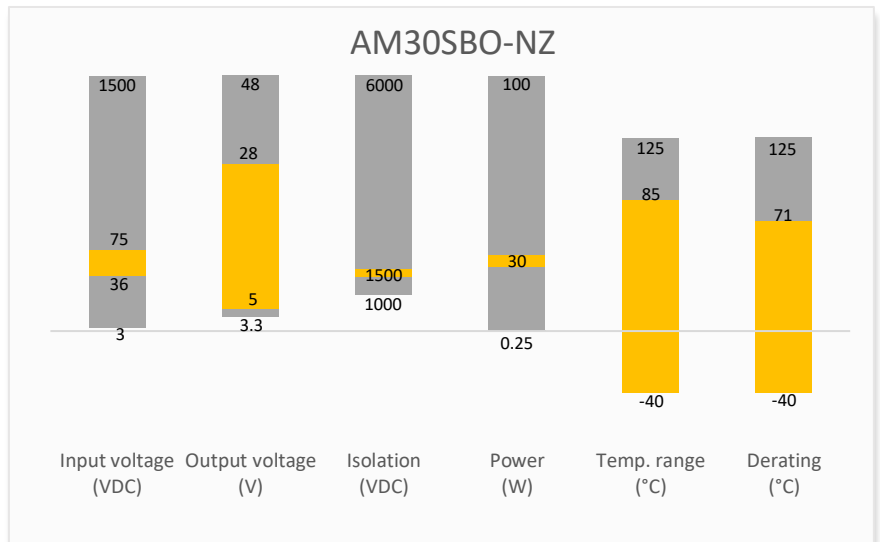

Training



Applications

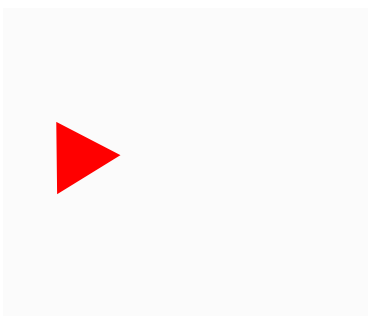

Product Training Video
(click to open)

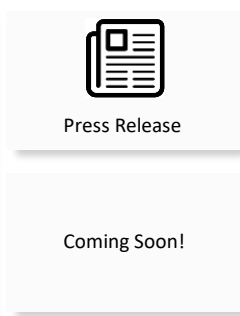

Application Notes



IoT



Industrial



Telecom



Portable Equipment

Models & Specifications



Single Output

Model	Input Voltage (VDC)	Output Voltage (VDC)	Maximum Output Current (A)	Maximum capacitive Load (μ F)	Efficiency Typ. (%)
AM30SBO-4805SNZ	48 (36-75)	5	6	7200	90
AM30SBO-4812SNZ	48 (36-75)	12	2.5	2000	90
AM30SBO-4815SNZ	48 (36-75)	15	2	1500	90
AM30SBO-4824SNZ	48 (36-75)	24	1.25	470	90
AM30SBO-4828SNZ	48 (36-75)	28	1.072	440	90

Input Specification

Parameters	Conditions	Typical	Maximum	Units
Input current	Nominal input voltage, full load /no load	695/6	711/15	mA
Filter	Capacitor filter			
Absolute maximum rating	Maximum duration 1s	>0.7	100	VDC
Input reflected ripple current		50		mA
Start-up voltage			36	VDC
UVLO		29		VDC
On/Off control	On	Control pin open or 3.5-12VDC		
	Off	Control pin short to -Vin or 0-1.2VDC		
	Idle current	6	10	mA

Isolation Specification

Parameters	Conditions	Typical	Maximum	Units
Tested I/O voltage	60 sec, leakage \leq 1mA	>1500		VDC
Resistance	500VDC	>1000		M Ω
Capacitance	100kHz/0.1V	1000		pF

Output Specification

Parameters	Conditions	Typical	Maximum	Units
Voltage accuracy	5-100% load	\pm 1	\pm 3	%
Line regulation	LL-HL	\pm 0.2	\pm 0.5	%
Load regulation	5-100% load	\pm 0.5	\pm 1	%
Temperature coefficient			\pm 0.03	%/ $^{\circ}$ C
Ripple & Noise*	Nominal input voltage, 5-100% load	100	150	mV pk-pk
	Nominal input voltage, 0-5% load		5	% of Vout
Transient Recovery Time	25% load step change	300	500	μ s
Transient Response Deviation	25% load step change, 5V output	\pm 5	\pm 8	%
	25% load step change, others	\pm 3	\pm 5	%
Trim			\pm 10	%
Sense compensation			5	%
Start-up time	Nominal input voltage, constant resistance load		100	ms

* Ripple and Noise are measured at 20MHz bandwidth. Please refer to the application note for specific details.

General Specifications				
Parameters	Conditions	Typical	Maximum	Units
Switching frequency*	Full load, nominal input	230		KHz
Short circuit protection	Continuous, auto recovery			
Over voltage protection		≥ 110	160	% of Vo
Over current protection		≥ 110	190	% of Io
Over temperature protection	Surface temperature	130		°C
Operating temperature	With derating	-40 to +85		°C
Storage temperature		-55 to +125		°C
Cooling	Free air convection or forced air convection			
Humidity	Non-condensing	>5	95	% RH
Weight		12		g
Dimensions (L x W x H)		1.30 x 0.90 x 0.36 inches (33.02 x 22.86 x 9.18 mm)		
MTBF	1 000 000 hrs (MIL-HDBK -217F, t=+25°C) / Full Load			

* Switching frequency reduced when load < 50%.
NOTE: All specifications in this datasheet are measured at an ambient temperature of 25°C, humidity<75%, nominal input voltage and at rated output load unless otherwise specified.

Environment Approval	
Parameters	Conditions
Vibration	10-150Hz, 5G, 0.75mm, along all axis

Safety Specifications		
Parameters		
Standards	Information technology Equipment	Design to meet EN 62368
	EMC - Conducted and radiated emission	CISPR32 / EN55032, class B with the recommended EMC circuit(Part A)
	Electrostatic Discharge Immunity	IEC 61000-4-2 Contact ±4KV, Criteria B
	RF, Electromagnetic Field Immunity	EN 61000-4-3, 10V/m, Criteria A
	Electrical Fast Transient/Burst Immunity	EN 61000-4-4, ±2KV, Criteria B with the recommended EMC circuit(Part B)
	Surge Immunity	EN 61000-4-5, L-L ±2KV, Criteria B with the recommended EMC circuit(Part B)
	RF, Conducted Disturbance Immunity	EN 61000-4-6, 3Vr.m.s, Criteria A

Derating

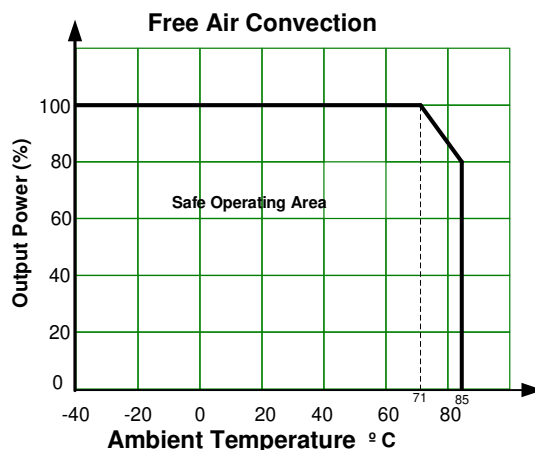

Typical application circuit

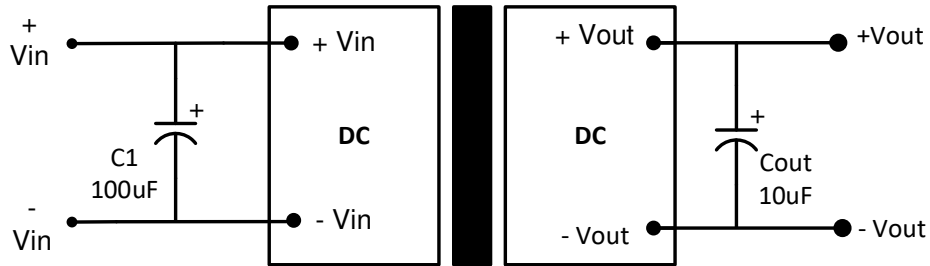

- Note:
1. When not using the sense function, connect the +sense to +Vout and -sense to -Vout with the shortest possible traces to avoid interference and minimize the voltage drop.
 2. When using the sense function, connect the sense pins to the load with the shortest possible traces, twisted pair wire or shielded wire and make sure the voltage drop is less than 0.3V.

Recommended EMC circuit

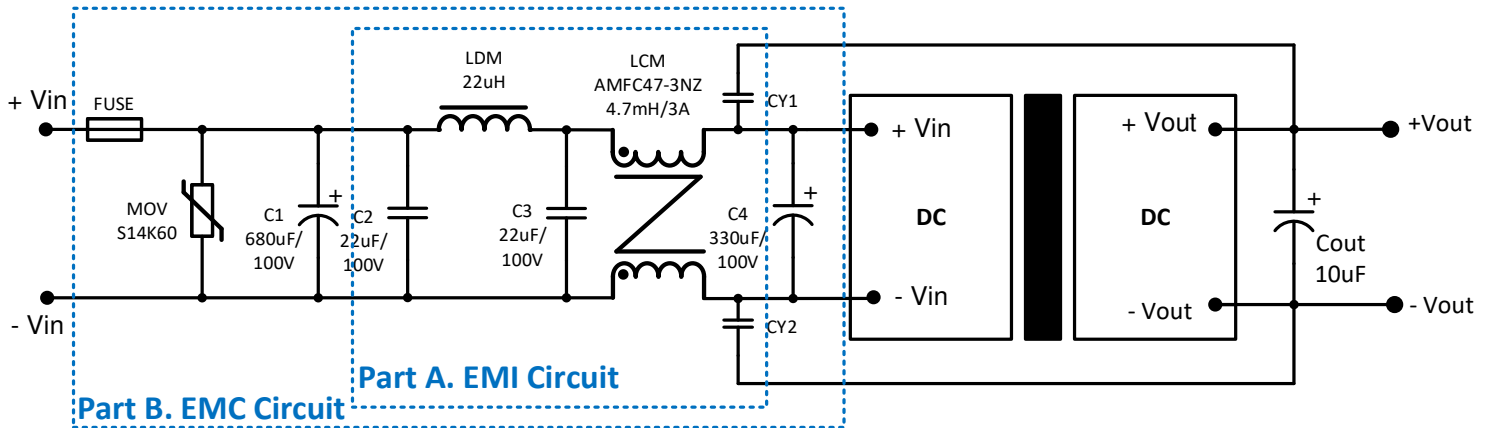

Component	28Vout	Others
Fuse	Select value based on input current	
CY1	2.2nF/2KV	2.2nF/2KV
CY2	3.2nF/2KV	2.2nF/2KV

Dimensions

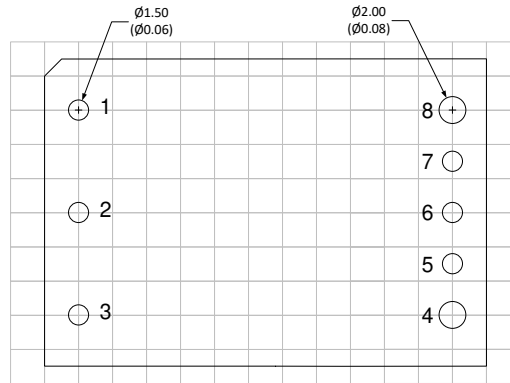
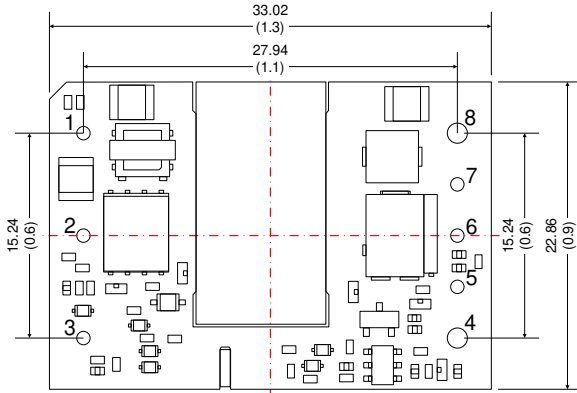

Grid size: 2.54 x 2.54mm

Pin Out Specifications	
Pin	Single
1	+Vin
2	On/Off Control
3	-Vin
4	-Vout
5	-Sense
6	Trim
7	+Sense
8	+Vout

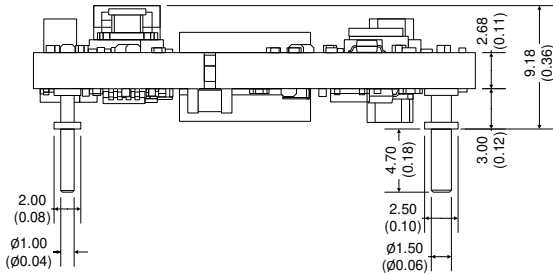

Note:
Unit: mm(inch)
General tolerance: ± 0.5 (0.02)
Pin dimension tolerance: ± 0.1 (0.004)

Trim

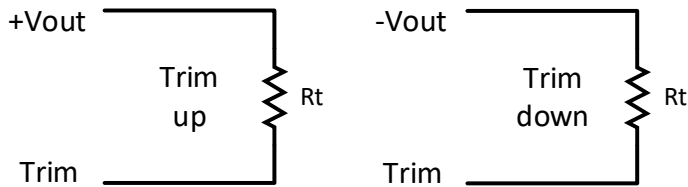

Leave open if not used.

Vout = 5V

Trim down %	1	2	3	4	5	6	7	8	9	10
Vout (VDC)	4.95	4.9	4.85	4.8	4.75	4.7	4.65	4.6	4.55	4.5
Rt down (K Ω)	500.78	245.28	160.11	117.53	91.98	74.95	62.78	53.66	46.56	40.88
Trim up %	1	2	3	4	5	6	7	8	9	10
Vout (VDC)	5.05	5.1	5.15	5.2	5.25	5.3	5.35	5.4	5.45	5.5
Rt up (K Ω)	1585.35	797.99	535.54	404.32	325.58	273.09	235.60	207.48	185.61	168.11

Vout = 12V

Trim down %	1	2	3	4	5	6	7	8	9	10
Vout (VDC)	11.88	11.76	11.64	11.52	11.4	11.28	11.16	11.04	10.92	10.8
Rt down (K Ω)	500.78	245.28	160.11	117.53	91.98	74.95	62.78	53.66	46.56	40.88
Trim up %	1	2	3	4	5	6	7	8	9	10
Vout (VDC)	12.12	12.24	12.36	12.48	12.6	12.72	12.84	12.96	13.08	13.2
Rt up (K Ω)	4534.55	2287.19	1538.08	1163.52	938.78	788.96	681.94	601.68	539.25	489.31

Vout = 15V

Trim down %	1	2	3	4	5	6	7	8	9	10
Vout (VDC)	14.85	14.7	14.55	14.4	14.25	14.1	13.95	13.8	13.65	13.5
Rt down (KΩ)	500.78	245.28	160.11	117.53	91.98	74.95	62.78	53.66	46.56	40.88
Trim up %	1	2	3	4	5	6	7	8	9	10
Vout (VDC)	15.15	15.3	15.45	15.6	15.75	15.9	16.05	16.2	16.35	16.5
Rt up (KΩ)	5798.49	2925.42	1967.73	1488.89	1201.58	1010.04	873.23	770.62	690.81	626.97

Vout = 24V

Trim down %	1	2	3	4	5	6	7	8	9	10
Vout (VDC)	23.76	23.52	23.28	23.04	22.8	22.56	22.32	22.08	21.84	21.6
Rt down (KΩ)	500.78	245.28	160.11	117.53	91.98	74.95	62.78	53.66	46.56	40.88
Trim up %	1	2	3	4	5	6	7	8	9	10
Vout (VDC)	24.24	24.48	24.72	24.96	25.2	25.44	25.68	25.92	26.16	26.4
Rt up (KΩ)	9590.32	4840.11	3256.70	2465.00	1989.98	1673.30	1447.10	1277.45	1145.50	1039.94

Vout = 28V

Trim down %	1	2	3	4	5	6	7	8	9	10
Vout (VDC)	27.72	27.44	27.16	26.88	26.6	26.32	26.04	25.76	25.48	25.2
Rt down (KΩ)	500.78	245.28	160.11	117.53	91.98	74.95	62.78	53.66	46.56	40.88
Trim up %	1	2	3	4	5	6	7	8	9	10
Vout (VDC)	28.28	28.56	28.84	29.12	29.4	29.68	29.96	30.24	30.52	30.8
Rt up (KΩ)	11275.58	5691.08	3829.58	2898.83	2340.38	1968.08	1702.15	1502.71	1347.58	1223.48

NOTE: **1.** Datasheets are updated as needed and as such, specifications are subject to change without notice. Once printed or downloaded, datasheets are no longer controlled by Aimtec; refer to www.aimtec.com for the most current product specifications. **2.** Product labels shown, including safety agency certifications on labels, may vary based on the date manufactured. **3.** Mechanical drawings and specifications are for reference only. **4.** All specifications are measured at an ambient temperature of 25°C, humidity<75%, nominal input voltage and at rated output load unless otherwise specified. **5.** Aimtec may not have conducted destructive testing or chemical analysis on all internal components and chemicals at the time of publishing this document. CAS numbers and other limited information are considered proprietary and may not be available for release. **6.** This product is not designed for use in critical life support systems, equipment used in hazardous environments, nuclear control systems or other such applications which necessitate specific safety and regulatory standards other the ones listed in this datasheet. **7.** Warranty is in accordance with Aimtec's standard Terms of Sale available at www.aimtec.com.