



Main

Range of Product	Zelio Logic
Product or Component Type	Discrete I/O extension module

Complementary

Number of control scheme lines	120 ladder
Cycle time	6...90 ms
Backup time	10 years 77 °F (25 °C)
Clock drift	12 min/year 32...131 °F (0...55 °C)
Checks	Program memory on each power up
[Us] rated supply voltage	24 V AC
Supply voltage limits	20.4...28.8 V
Supply frequency	50/60 Hz
Reverse polarity protection	With
Discrete input number	4
Discrete input voltage	24 V AC
Discrete input current	4.4 mA
Discrete input frequency	47...53 Hz 57...63 Hz
Voltage state 1 guaranteed	>= 14 V discrete input
Voltage state 0 guaranteed	<= 5 V discrete input
Current state 1 guaranteed	>= 2 mA discrete input)
Current state 0 guaranteed	<= 0.5 mA discrete input)
Input impedance	4.6 kOhm discrete input
Number of Outputs	2 relay
Output voltage limits	5...30 V DC relay output) 24...250 V AC
Contacts type and composition	NO relay output
Output thermal current	8 A for all 2 outputs relay output
Electrical durability	AC-15 500000 cycles 230 V, 0.9 A relay output EN/IEC 60947-5-1 AC-12 500000 cycles 230 V, 1.5 A relay output EN/IEC 60947-5-1 DC-13 500000 cycles 24 V, 0.6 A relay output EN/IEC 60947-5-1 DC-12 500000 cycles 24 V, 1.5 A relay output EN/IEC 60947-5-1
Switching capacity in mA	>= 10 mA 12 V relay output)
Operating rate in Hz	0.1 Hz at Ie)relay output 10 Hz no load)relay output
Mechanical durability	10000000 cycles relay output
[Uimp] rated impulse withstand voltage	4 kV EN/IEC 60947-1 and EN/IEC 60664-1

The information provided in this documentation contains general descriptions and/or technical characteristics of the performance of the products contained herein. This documentation is not intended as a substitute for and is not to be used for determining suitability or reliability of these products for specific user applications. It is the duty of any such user or integrator to perform the appropriate and complete risk analysis, evaluation and testing of the products with respect to the relevant specific application or use thereof. Neither Schneider Electric Industries SAS nor any of its affiliates or subsidiaries shall be responsible or liable for misuse of the information contained herein.

Response time	50 ms ladder from state 0 to state 1)discrete input 50 ms ladder from state 1 to state 0)discrete input 50...255 ms FBD from state 0 to state 1)discrete input 50...255 ms FBD from state 1 to state 0)discrete input 10 ms from state 0 to state 1)relay output 5 ms from state 1 to state 0)relay output
Connections - terminals	Screw terminals, 1 x 0.25...1 x 2.5 mm ² AWG 24...AWG 14) flexible with cable end Screw terminals, 2 x 0.25...2 x 0.75 mm ² AWG 24...AWG 18) flexible with cable end Screw terminals, 1 x 0.2...1 x 2.5 mm ² AWG 25...AWG 14) semi-solid Screw terminals, 1 x 0.2...1 x 2.5 mm ² AWG 25...AWG 14) solid Screw terminals, 2 x 0.2...2 x 1.5 mm ² AWG 24...AWG 16) solid
Tightening torque	4.43 lbf.in (0.5 N.m)
Overvoltage category	III EN/IEC 60664-1
Net Weight	0.28 lb(US) (0.125 kg)

Environment

Product Certifications	CSA GL GOST UL C-tick
Standards	EN/IEC 61000-4-12 EN/IEC 61000-4-6 level 3 EN/IEC 61000-4-3 EN/IEC 60068-2-27 Ea EN/IEC 61000-4-4 level 3 EN/IEC 61000-4-11 EN/IEC 61000-4-5 EN/IEC 61000-4-2 level 3 EN/IEC 60068-2-6 Fc
IP degree of protection	IP20 IEC 60529 terminal block) IP40 IEC 60529 front panel)
Environmental characteristic	EMC directive EN/IEC 61000-6-2 EMC directive EN/IEC 61000-6-3 EMC directive EN/IEC 61000-6-4 EMC directive EN/IEC 61131-2 zone B Low voltage directive EN/IEC 61131-2
Disturbance radiated/conducted	Class B EN 55022-11 group 1
Pollution degree	2 EN/IEC 61131-2
Ambient air temperature for operation	-4...104 °F (-20...40 °C) in non-ventilated enclosure IEC 60068-2-1 and IEC 60068-2-2 -4...131 °F (-20...55 °C) IEC 60068-2-1 and IEC 60068-2-2
Ambient Air Temperature for Storage	-40...158 °F (-40...70 °C)
Operating altitude	6561.68 ft (2000 m)
Maximum altitude transport	10000.00 ft (3048 m)
Relative Humidity	95 % without condensation or dripping water

Ordering and shipping details





Category	22378 - SR2,3 ZELIO 2 RELAYS
Discount Schedule	I
GTIN	3389110550177
Nbr. of units in pkg.	1
Package weight(Lbs)	4.16 oz (118 g)
Returnability	No
Country of origin	FR

Packing Units

Unit Type of Package 1	PCE
Package 1 Height	2.36 in (6 cm)
Package 1 width	2.56 in (6.5 cm)
Package 1 Length	4.33 in (11 cm)
Unit Type of Package 2	S03

Number of Units in Package 2	48
Package 2 Weight	13.84 lb(US) (6.276 kg)
Package 2 Height	11.81 in (30 cm)
Package 2 width	11.81 in (30 cm)
Package 2 Length	15.75 in (40 cm)

Offer Sustainability

Sustainable offer status	Green Premium product
California proposition 65	WARNING: This product can expose you to chemicals including: Lead and lead compounds, which is known to the State of California to cause cancer and birth defects or other reproductive harm. For more information go to www.P65Warnings.ca.gov
REACH Regulation	 REACH Declaration
EU RoHS Directive	Pro-active compliance (Product out of EU RoHS legal scope)  EU RoHS Declaration
Mercury free	Yes
RoHS exemption information	 Yes
China RoHS Regulation	 China RoHS Declaration
Environmental Disclosure	 Product Environmental Profile
Circularity Profile	 End Of Life Information
WEEE	The product must be disposed on European Union markets following specific waste collection and never end up in rubbish bins.
PVC free	Yes

Contractual warranty

Warranty	18 months
----------	-----------

I/O Extension Modules

Mounting on 35 mm/1.38 in. DIN Rail

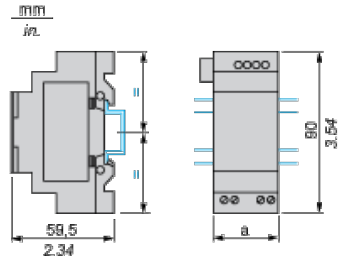

Screw Fixing (Retractable Lugs)

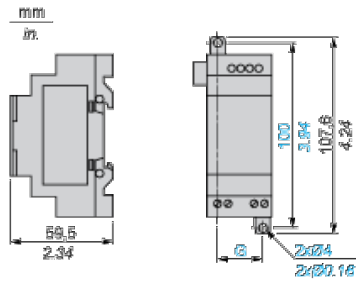

SR3	a (mm/in.)	G (mm/in.)
XT61••	35 / 1.38	25 / 0.98
XT101••	72 / 2.83	60 / 2.36
XT141••	72 / 2.83	60 / 2.36

Connection of Smart Relays on AC Supply

SR...1B, SR...1FU

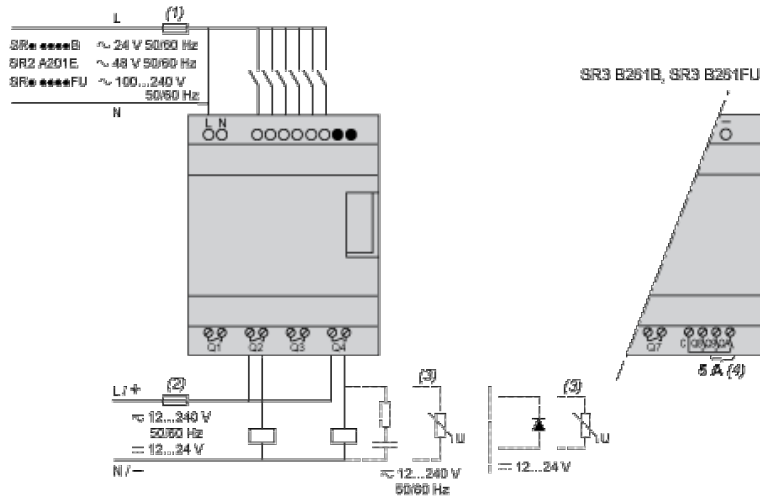

With Discrete I/O Extension Module

SR3B...B + SR3XT...B, SR3B...FU + SR3XT...FU

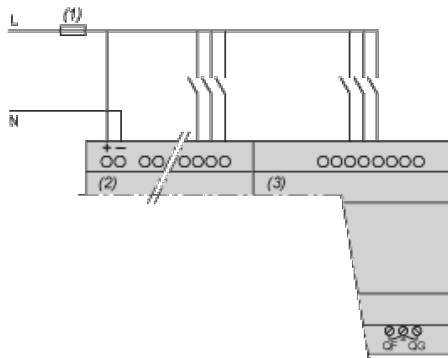

Compact and Modular Smart Relays

Electrical Durability of Relay Outputs

(in millions of operating cycles, conforming to IEC/EN 60947-5-1)

AC-12 (1)

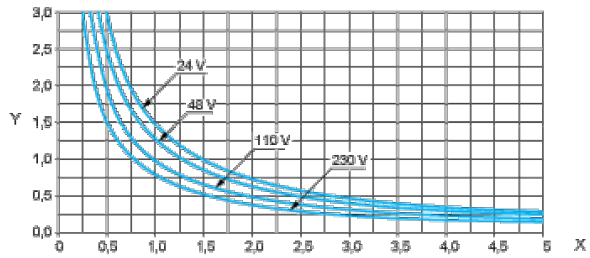

X: Current (A)

Y: Millions of operating cycles

(1) AC-12: switching resistive loads and opto-coupler isolated solid-state loads, $\cos \geq 0.9$.

AC-14 (1)

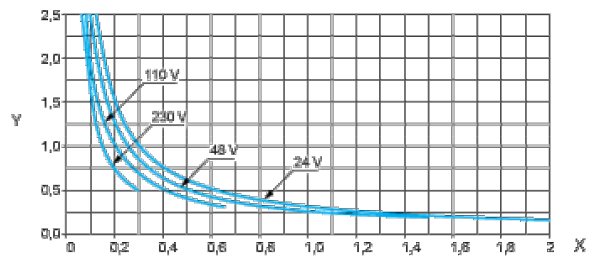

X: Current (A)

Y: Millions of operating cycles

(1) AC-14: switching small electromagnetic loads ≤ 72 VA, make: $\cos = 0.3$, break: $\cos = 0.3$.

AC-15 (1)

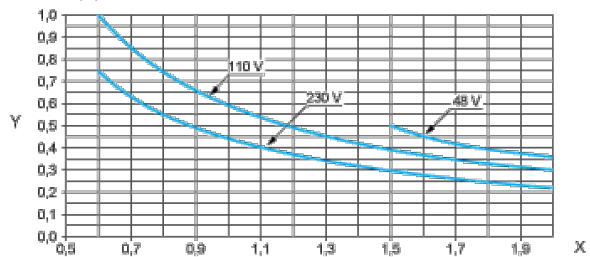

X: Current (A)

Y: Millions of operating cycles

(1) AC-15: switching electromagnetic loads ≥ 72 VA, make: $\cos = 0.7$, break: $\cos = 0.4$.