



Parameter	Ratings	Units
Blocking Voltage	250	$V_P$
Load Current	150	$mA_{rms} / mA_{DC}$
On-Resistance (max)	15	$\Omega$

## Features

- Current Limited 1-Form-A Relay
- 3750V<sub>rms</sub> Input/Output Isolation
- Low Drive Power Requirements
- Greater Reliability than Electromechanical Relays
- FCC Compatible
- VDE Compatible
- No EMI/RFI Generation
- Small 8-Pin Package
- Flammability Rating UL 94 V-0
- Surface Mount, Tape & Reel Version Available

## Applications

- Telecommunications
  - Telecom Switching
  - Tip/Ring Circuits
  - Modem Switching (Laptop, Notebook, Pocket Size)
  - Hook Switch
  - Dial Pulsing
  - Ground Start
  - Ringing Injection
- Instrumentation
- Multiplexers
- Data Acquisition
- Electronic Switching
- I/O Subsystems
- Meters (Watt-Hour, Water, Gas)
- Medical Equipment-Patient/Equipment Isolation
- Security
- Industrial Controls

## Description

LBA127L comprises two independent solid state relays (one current-limited, single-pole, normally open (1-Form-A) relay and one single-pole, normally closed (1-Form-B) relay), in an 8-pin package that employs optically coupled MOSFET technology to provide 3750V<sub>rms</sub> of input to output isolation.

The optically coupled relay outputs, which use the patented OptoMOS architecture, are controlled by a highly efficient infrared LED.

LBA127L is designed to provide an ideal solution where a complementary Form-A/Form-B relay pair is required in a space-saving single package.

## Approvals

- UL Recognized Component: File # E76270
- CSA Certified Component: Certificate # 1175739
- TUV EN 62368-1: Certificate # B 082667 0008

## Ordering Information

Part #	Description
LBA127L	8-Pin DIP (50/Tube)
LBA127LS	8-Pin Surface Mount (50/Tube)
LBA127LSTR	8-Pin Surface Mount (1,000/Reel)

## Pin Configuration

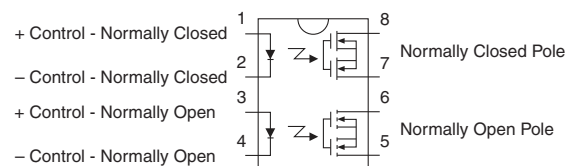

Switching Characteristics of Normally Open (Form A) Devices

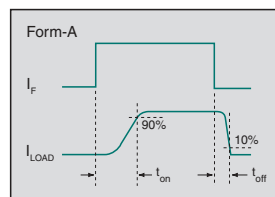

Switching Characteristics of Normally Closed (Form B) Devices

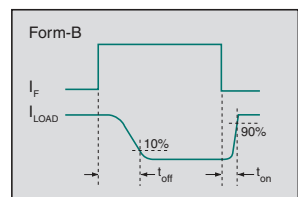

### Absolute Maximum Ratings @ 25°C

Parameter	Ratings	Units
Blocking Voltage	250	$V_P$
Reverse Input Voltage	5	V
Input Control Current	50	mA
Peak (10ms)	1	A
Input Power Dissipation <sup>1</sup>	150	mW
Total Power Dissipation <sup>2</sup>	800	mW
Isolation Voltage, Input to Output	3750	$V_{rms}$
Operational Temperature, Ambient	-40 to +85	°C
Storage Temperature	-40 to +125	°C

<sup>1</sup> Derate linearly 1.33 mW / °C

<sup>2</sup> Derate output power linearly 6.67 mW / °C

*Absolute Maximum Ratings are stress ratings. Stresses in excess of these ratings can cause permanent damage to the device. Functional operation of the device at conditions beyond those indicated in the operational sections of this data sheet is not implied.*

*Typical values are characteristic of the device at +25°C, and are the result of engineering evaluations. They are provided for information purposes only, and are not part of the manufacturing testing requirements.*

### Electrical Characteristics @ 25°C

Parameter	Conditions	Symbol	Min	Typ	Max	Units
<b>Output Characteristics</b>						
Blocking Voltage	$I_L=1\mu A$	$V_{DRM}$	250	-	-	$V_P$
Load Current						
Continuous <sup>1</sup>	-	$I_L$	-	-	150	$mA_{rms} / mA_{DC}$
Peak (Form-B Only)	$t = 10ms$	$I_{LPK}$	-	-	±400	$mA_P$
Current Limiting (Form-A Only)	$I_F=5mA, V_L=8V$	$I_{CL}$	±190	±200	±280	mA
On-Resistance <sup>2</sup>	$I_L=150mA$	$R_{ON}$	-	6.8	15	$\Omega$
Off-State Leakage Current	$V_L=250V_P$	$I_{LEAK}$	-	-	1	$\mu A$
Switching Speeds						
Turn-On	$I_F=5mA, V_L=10V$	$t_{on}$	-	-	5	ms
Turn-Off		$t_{off}$	-	-	5	
Output Capacitance	$V_L=50V, f=1MHz$	$C_{OUT}$	-	110	-	pF
<b>Input Characteristics</b>						
Input Control Current to Activate	$I_L=150mA$	$I_F$	-	-	5	mA
Input Control Current to Deactivate	-	-	0.4	0.7	-	mA
Input Voltage Drop	$I_F=5mA$	$V_F$	0.9	1.36	1.5	V
Reverse Input Current	$V_R=5V$	$I_R$	-	-	10	$\mu A$
<b>Common Characteristics</b>						
Input to Output Capacitance	$V_{IO}=0V, f=1MHz$	$C_{IO}$	-	3	-	pF

<sup>1</sup> If both poles operate, then the load current must be derated so as not to exceed the package power dissipation value.

<sup>2</sup> Measurement taken within 1 second of on-time.

Form-A/Form-B PERFORMANCE DATA\*

Typical LED Forward Voltage Drop  
(N=50,  $I_F=5mA$ )

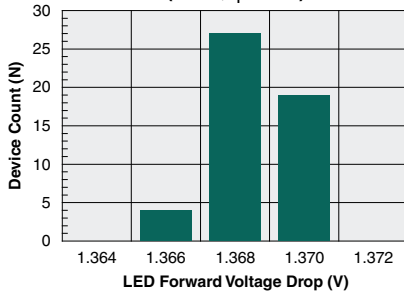

Typical  $I_F$  for Switch Operation  
(N=50,  $I_L=150mA_{DC}$ )

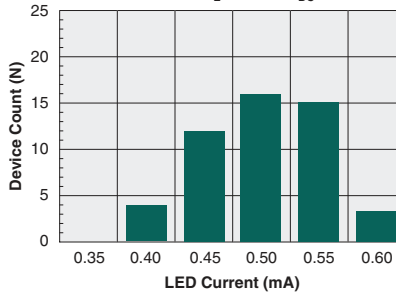

Typical Blocking Voltage Distribution  
(Form-A:  $I_F=0mA$ , Form-B:  $I_F=5mA$ )  
(N=50)

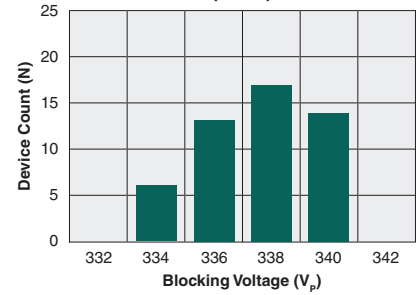

Typical LED Forward Voltage Drop  
vs. Temperature

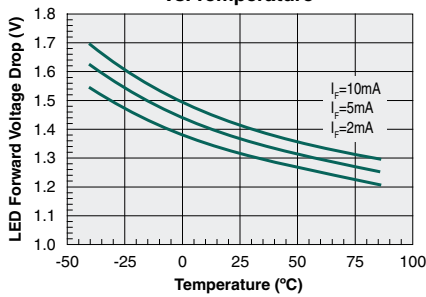

Typical  $I_F$  for Switch Operation  
vs. Temperature  
( $I_L=75mA_{DC}$ )

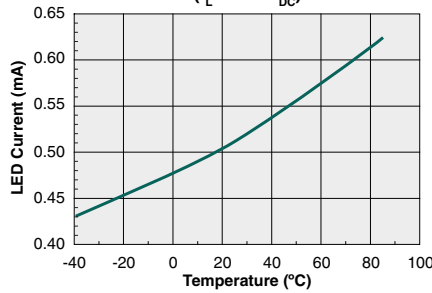

Load Current vs. Load Temperature  
(Form-A:  $I_F=5mA$ , Form-B:  $I_F=0mA$ )

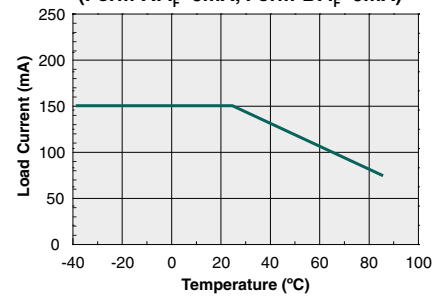

Typical Blocking Voltage  
vs. Temperature  
(Form-A:  $I_F=0mA$ , Form-B:  $I_F=5mA$ )

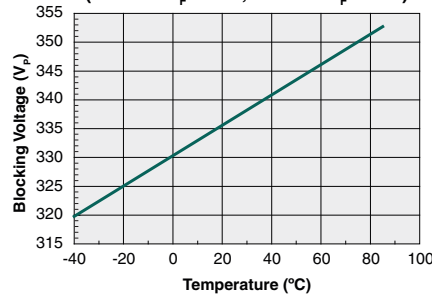

\*Unless otherwise noted, data presented in these graphs is typical of device operation at 25 $^{\circ}C$ .

**Form-A RELAY PERFORMANCE DATA\***

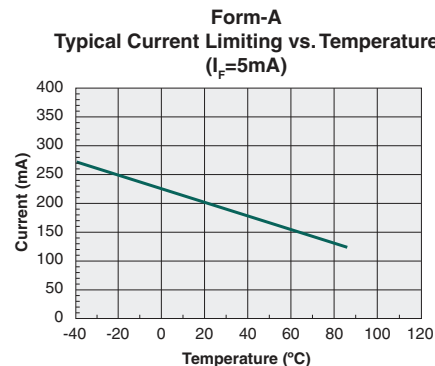
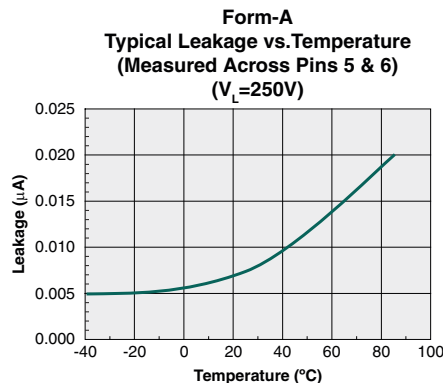
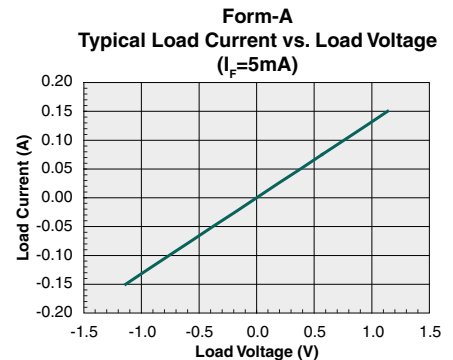
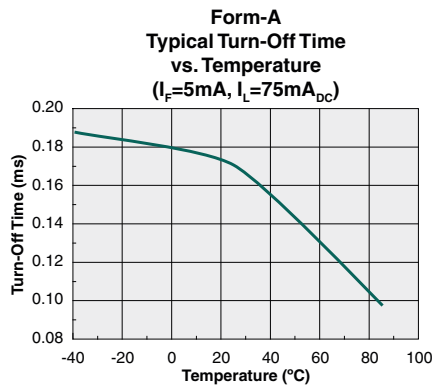
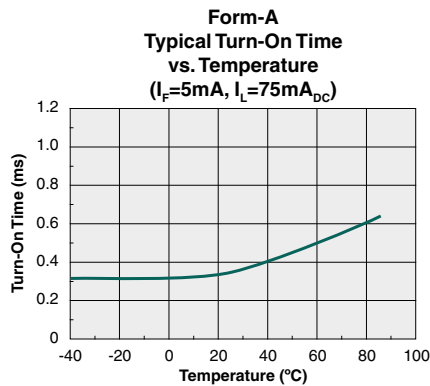
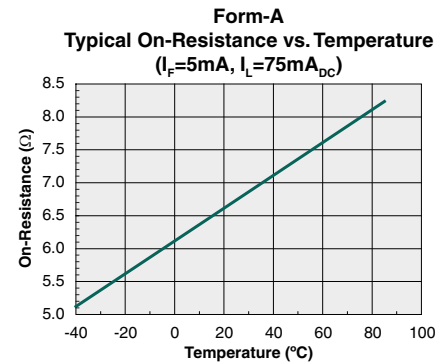
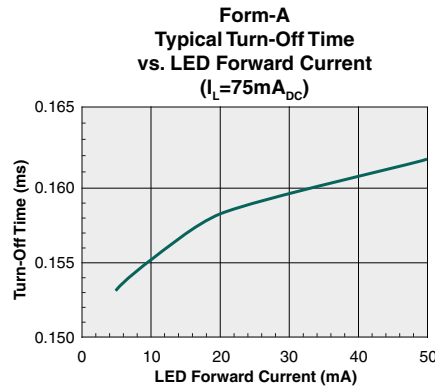
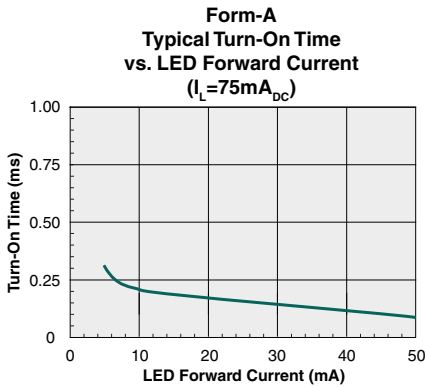
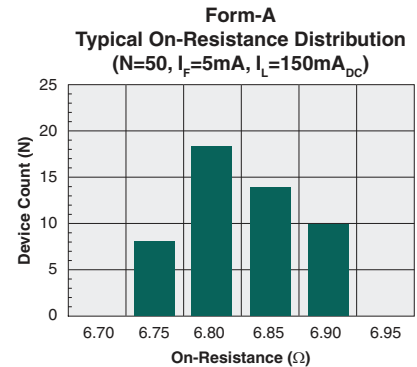
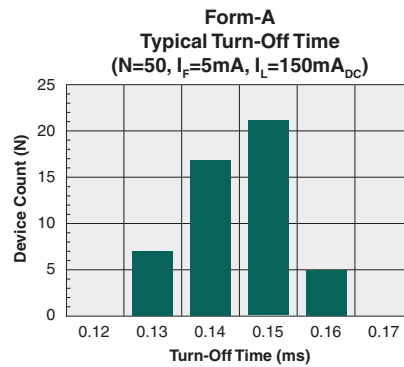
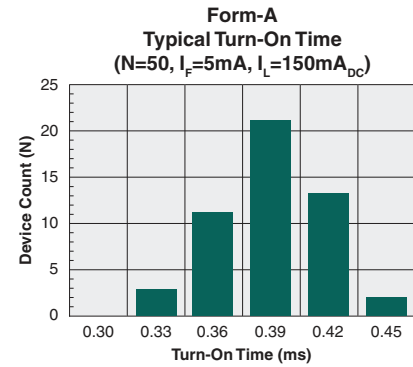

\*Unless otherwise noted, data presented in these graphs is typical of device operation at 25°C.

**Form-B RELAY PERFORMANCE DATA\***

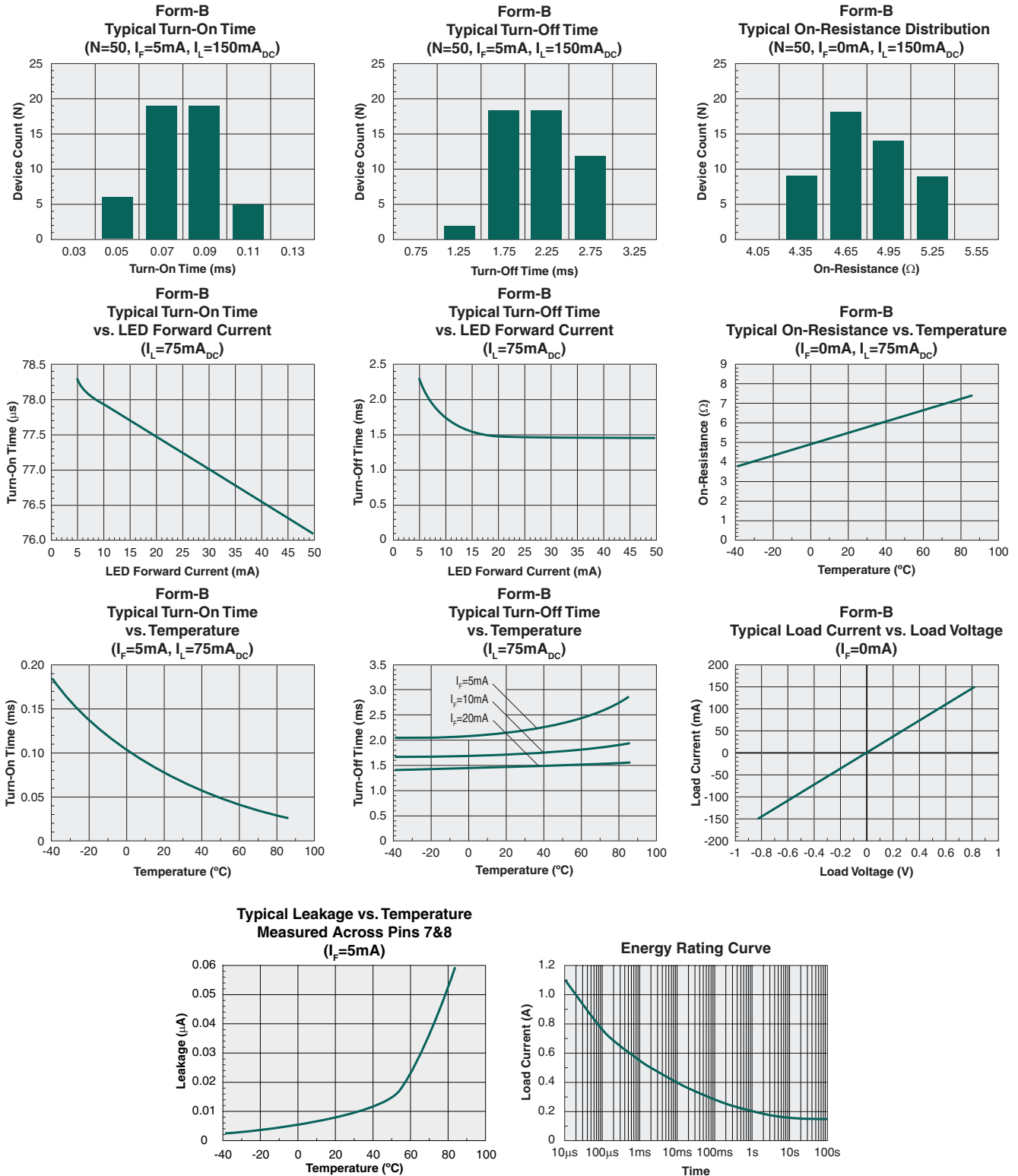

\*Unless otherwise noted, data presented in these graphs is typical of device operation at 25°C.

## Manufacturing Information

### Moisture Sensitivity



All plastic encapsulated semiconductor packages are susceptible to moisture ingress. IXYS Integrated Circuits classifies its plastic encapsulated devices for moisture sensitivity according to the latest version of the joint industry standard, **IPC/JEDEC J-STD-020**, in force at the time of product evaluation. We test all of our products to the maximum conditions set forth in the standard, and guarantee proper operation of our devices when handled according to the limitations and information in that standard as well as to any limitations set forth in the information or standards referenced below.

Failure to adhere to the warnings or limitations as established by the listed specifications could result in reduced product performance, reduction of operable life, and/or reduction of overall reliability.

This product carries a **Moisture Sensitivity Level (MSL)** classification as shown below, and should be handled according to the requirements of the latest version of the joint industry standard **IPC/JEDEC J-STD-033**.

Device	Moisture Sensitivity Level (MSL) Classification
LBA127LS	MSL 1

### ESD Sensitivity



This product is ESD Sensitive, and should be handled according to the industry standard **JESD-625**.

### Soldering Profile

Provided in the table below is the **IPC/JEDEC J-STD-020** Classification Temperature ( $T_C$ ) and the maximum total dwell time ( $t_p$ ) in all reflow processes that the body temperature of these surface mount devices may be ( $T_C - 5$ )°C or greater. The device's body temperature must not exceed the Classification Temperature at any time during reflow soldering processes.

Device	Classification Temperature ( $T_C$ )	Dwell Time ( $t_p$ )	Max Reflow Cycles
LBA127LS	250°C	30 seconds	3

For through-hole devices, the maximum pin temperature and maximum dwell time through all solder waves is provided in the table below. Dwell time is the interval beginning when the pins are initially immersed into the solder wave until they exit the solder wave. For multiple waves, the dwell time is from entering the first wave until exiting the last wave. During this time, pin temperatures must not exceed the maximum temperature given in the table below. Body temperature of the device must not exceed the limit shown in the table below at any time during the soldering process.

Device	Maximum Pin Temperature	Maximum Body Temperature	Maximum Dwell Time	Wave Cycles
LBA127L	260°C	250°C	10 seconds*	1

\*Total cumulative duration of all waves.

### Board Wash

IXYS Integrated Circuits recommends the use of no-clean flux formulations. Board washing to reduce or remove flux residue following the solder reflow process is acceptable provided proper precautions are taken to prevent damage to the device. These precautions include but are not limited to: using a low pressure wash and providing a follow up bake cycle sufficient to remove any moisture trapped within the device due to the washing process. Due to the variability of the wash parameters used to clean the board, determination of the bake temperature and duration necessary to remove the moisture trapped within the package is the responsibility of the user (assembler). Cleaning or drying methods that employ ultrasonic energy may damage the device and should not be used. Additionally, the device must not be exposed to halide flux or solvents.



**MECHANICAL DIMENSIONS**

**LBA127L**

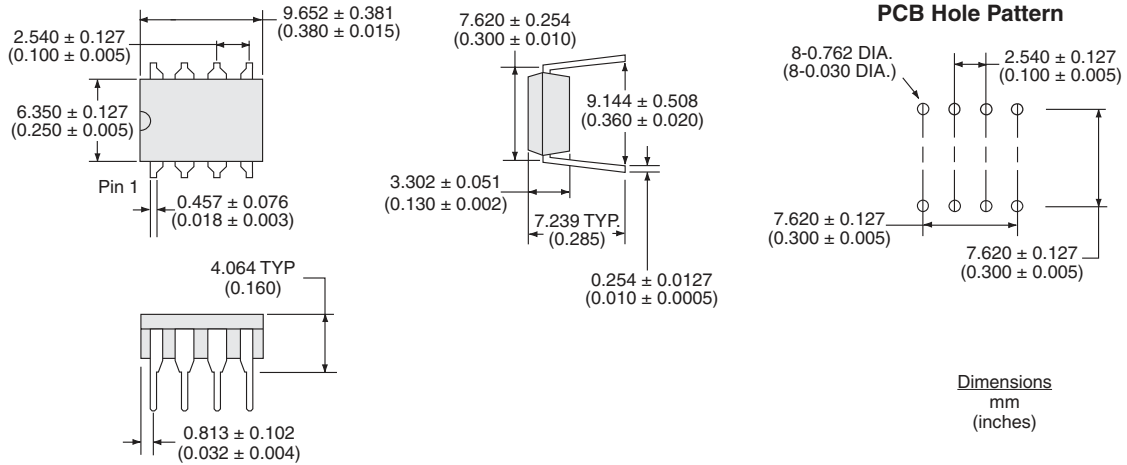

**LBA127LS**

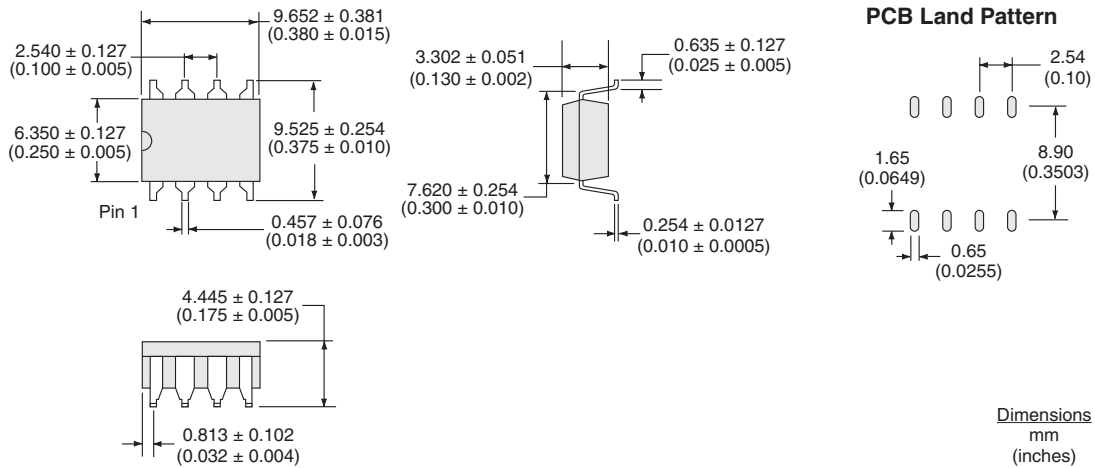

**MECHANICAL DIMENSIONS**

**LBA127LSTR Tape & Reel**

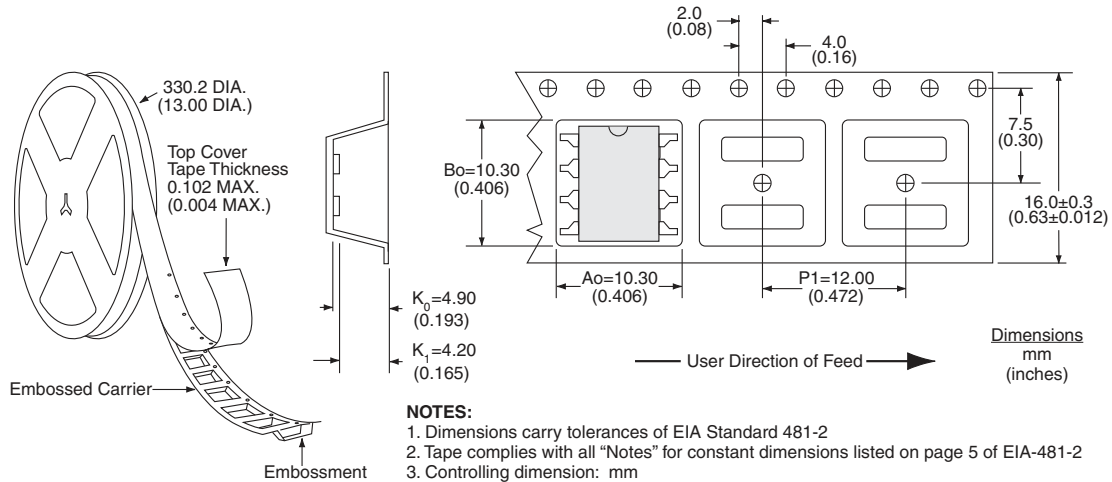

For additional information please visit our website at: <https://www.ixysic.com>