

TOSHIBA CMOS Linear Integrated Circuit Silicon Monolithic

TCR3RM series

Ultra high Ripple rejection ratio, 300 mA CMOS Low Dropout Regulator in ultra small package

1. Description

The TCR3RM series are CMOS general-purpose single-output voltage regulators with an on/off control input, featuring low output voltage noise and ultra-high Ripple rejection ratio.

These voltage regulators are available in fixed output voltages between 0.9 V and 4.5 V and capable of driving up to 300 mA. They feature Overcurrent protection, Thermal shutdown and Auto-discharge.

The TCR3RM series is offered in the ultra small plastic mold package DFN4C/DFN4F (1.0 mm x 1.0 mm; t 0.38 mm (Typ.)) and has a high ripple rejection ratio of 100 dB (f = 1 kHz, 2.8 V output).

As small ceramic input and output capacitors 1 μ F can be used with the TCR3RM series, these devices are ideal for portable applications that require high-density board assembly such as cellular phones.

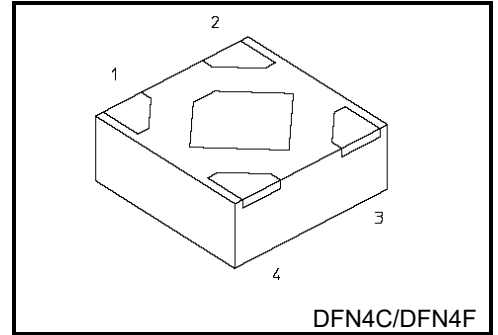

2. Applications

Power IC developed for portable applications

3. Features

- Ultra small package DFN4C/DFN4F (1.0 mm x 1.0 mm; t 0.38 mm (Typ.)).
- High Ripple rejection ratio 100 dB (Typ.) @1 kHz ($V_{OUT} = 2.8$ V)
- High Ripple rejection ratio 93 dB (Typ.) @10 kHz ($V_{OUT} = 2.8$ V)
- High Ripple rejection ratio 68 dB (Typ.) @100 kHz ($V_{OUT} = 2.8$ V)
- High Ripple rejection ratio 68 dB (Typ.) @1 MHz ($V_{OUT} = 2.8$ V)
- Low output noise voltage ($V_{NO} = 5 \mu V_{rms}$ (Typ.) at $10 \text{ Hz} \leq f \leq 100 \text{ kHz}$)
- Low quiescent current ($I_B = 7 \mu A$ (Typ.) at $I_{OUT} = 0$ mA)
- Overcurrent protection
- Thermal shutdown
- Auto-discharge
- Low Dropout voltage
 $V_{DO} = 130$ mV (Typ.), $V_{OUT} = 2.8$ V, $I_{OUT} = 300$ mA
- Wide range output voltage line up ($V_{OUT} = 0.9$ to 4.5 V)
- Pull down connection between CONTROL and GND
- Ceramic capacitors can be used ($C_{IN} = 1 \mu F$, $C_{OUT} = 1 \mu F$)

Start of commercial production
2020-09

4. Absolute Maximum Ratings (Ta = 25°C)

Characteristics	Symbol	Rating	Unit
Input voltage	V _{IN}	-0.3 to 6.0	V
Control voltage	V _{CT}	-0.3 to V _{IN} + 0.3 ≤ 6.0	V
Output voltage	V _{OUT}	-0.3 to V _{IN} + 0.3 ≤ 6.0	V
Output current	I _{OUT}	300	mA
Power dissipation	P _D	420 (Note1)	mW
Junction temperature	T _j	150	°C
Storage temperature range	T _{stg}	-55 to 150	°C

Note: Using continuously under heavy loads (e.g. the application of high temperature/current/voltage and the significant change in temperature, etc.) may cause this product to decrease in the reliability significantly even if the operating conditions (i.e. operating temperature/current/voltage, etc.) are within the absolute maximum ratings and the operating ranges.

Please design the appropriate reliability upon reviewing the Toshiba Semiconductor Reliability Handbook ("Handling Precautions"/"Derating Concept and Methods") and individual reliability data (i.e. reliability test report and estimated failure rate, etc).

Note1: Rating at mounting on a board

Glass epoxy(FR4) board dimension: 40mm x 40mm x 1.6mm, both sides of board.

Metal pattern ratio: a surface approximately 50%, the reverse side approximately 50%

5. Pin Assignment (top view)

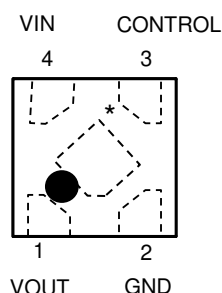

*Center electrode should be connected to GND or Open

6. Operating Ranges

Characteristics	Symbol	Ranges		Unit
Input voltage	V _{IN}	1.8 to 5.5	(Note 2)	V
Control voltage	V _{CT}	0 to V _{IN}		V
Output voltage	V _{OUT}	0.9 to 4.5		V
Output current	I _{OUT}	DC	300	mA
Operating Temperature	T _{opr}	-40 to 85		°C
Output Capacitance	C _{OUT}	≥ 1.0 μF		—
Input Capacitance	C _{IN}	≥ 1.0 μF		—

Note 2: Please refer to Dropout Voltage table(Page 6) and use it within Absolute Maximum Ratings Junction temperature and Operating Temperature Ranges.

7. List of Products Number, Output voltage and Marking

Product No.	Output voltage(V)	Marking
TCR3RM09A	0.9	0J9
TCR3RM095A	0.95	0JB
TCR3RM10A	1.0	1J0
TCR3RM105A	1.05	1JC
TCR3RM11A	1.1	1J1
TCR3RM115A	1.15	1JD
TCR3RM12A	1.2	1J2
TCR3RM13A	1.3	1J3
TCR3RM15A	1.5	1J5
TCR3RM16A	1.6	1J6
TCR3RM17A	1.7	1J7
TCR3RM18A	1.8	1J8
TCR3RM1825A	1.825	1JG
TCR3RM185A	1.85	1JH
TCR3RM19A	1.9	1J9
TCR3RM20A	2.0	2J0
TCR3RM22A	2.2	2J2
TCR3RM25A	2.5	2J5
TCR3RM26A	2.6	2J6
TCR3RM27A	2.7	2J7
TCR3RM28A	2.8	2J8
TCR3RM285A	2.85	2JJ
TCR3RM29A	2.9	2J9
TCR3RM30A	3.0	3J0
TCR3RM31A	3.1	3J1
TCR3RM32A	3.2	3J2
TCR3RM33A	3.3	3J3
TCR3RM35A	3.5	3J5
TCR3RM36A	3.6	3J6
TCR3RM40A	4.0	4J0
TCR3RM41A	4.1	4J1
TCR3RM42A	4.2	4J2
TCR3RM43A	4.3	4J3
TCR3RM45A	4.5	4J5

Top Marking (top view)

Example: TCR3RM28A (2.8 V output)

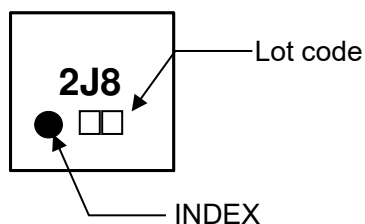

Block Diagram

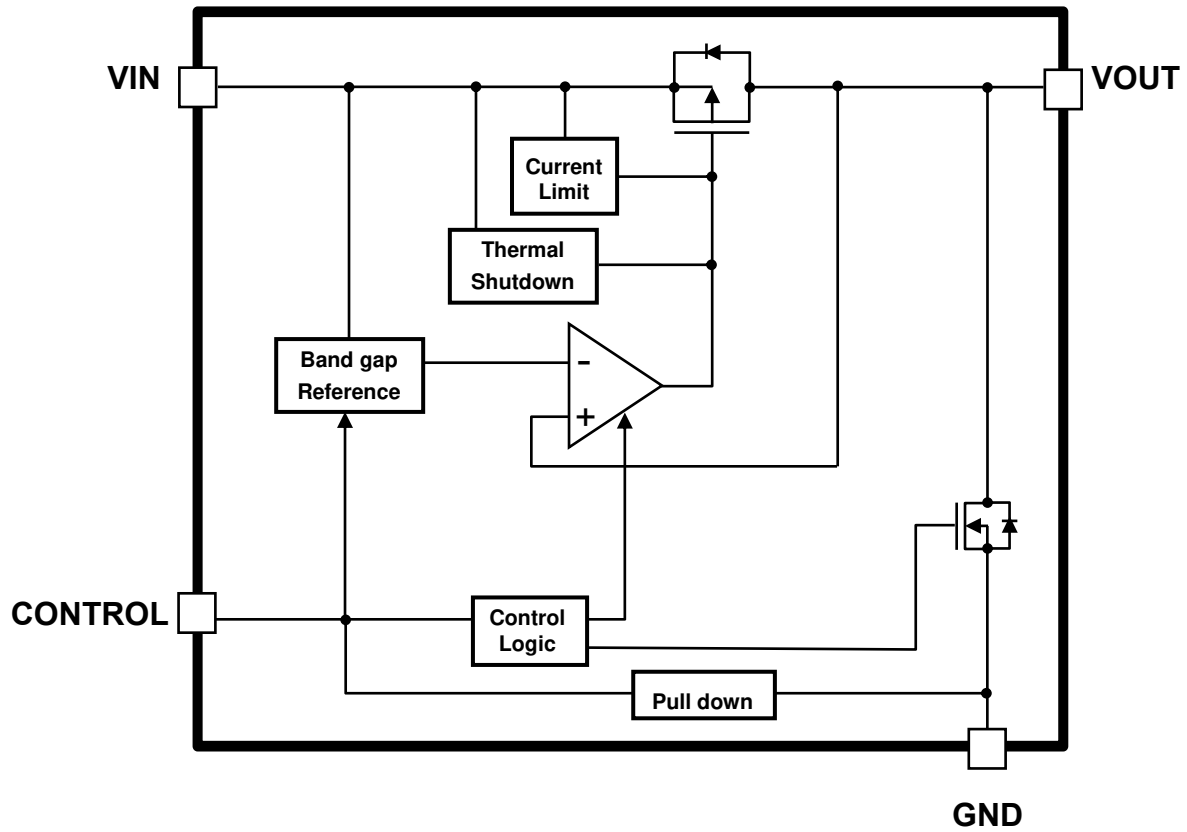

8. Electrical Characteristics

(Unless otherwise specified, $V_{IN} = V_{OUT} + 1\text{ V}$ ($V_{OUT} \geq 1\text{ V}$), $V_{IN} = 2\text{ V}$ ($V_{OUT} \leq 1\text{ V}$), $C_{IN} = C_{OUT} = 1\text{ }\mu\text{F}$)

Characteristics	Symbol	Test Condition	$T_j = 25^\circ\text{C}$			$T_j = -40\text{ to }85^\circ\text{C}$ (Note 6)		Unit		
			Min	Typ.	Max	Min	Max			
Output voltage accuracy	V_{OUT}	$I_{OUT} = 1\text{ to }300\text{ mA}$ $V_{IN} = V_{OUT} + 1\text{ V to }5.5\text{ V}$ (Note 3)	$V_{OUT} < 1.8\text{ V}$	—	—	—	-36	+36	mV	
			$1.8\text{ V} \leq V_{OUT}$	—	—	—	-2	+2	%	
Line regulation	Reg·line	$V_{OUT} + 1\text{ V} \leq V_{IN} \leq 5.5\text{ V}$ $I_{OUT} = 1\text{ mA}$	—	0.025	—	—	—	—	%/V	
Load regulation	Reg·load	$1\text{ mA} \leq I_{OUT} \leq 300\text{ mA}$	—	12	—	—	—	—	mV	
Quiescent current	$I_{B(ON)}$	$I_{OUT} = 0\text{ mA}$ (Note 5)	—	7	—	—	—	12	μA	
Stand-by current	$I_{B(OFF)}$	$V_{CT} = 0\text{ V}$	—	0.1	—	—	—	1.0	μA	
Control pull down current	I_{CT}	—	—	0.1	—	—	—	0.2	μA	
Drop-out voltage (Note 7)	V_{DO}	$I_{OUT} = 300\text{ mA}$	$V_{OUT} = 1.8\text{ V}$	—	180	—	—	—	220	mV
			$V_{OUT} = 2.8\text{ V}$	—	130	—	—	—	150	mV
			$V_{OUT} = 4.5\text{ V}$	—	98	—	—	—	125	mV
Output noise voltage	V_{NO}	$I_{OUT} = 10\text{ mA}$ $10\text{ Hz} \leq f \leq 100\text{ kHz}$, $T_a = 25^\circ\text{C}$ (Note 4)	—	5	—	—	—	—	μV_{rms}	
Ripple rejection ratio	R.R.	$I_{OUT} = 10\text{ mA}$, $V_{Ripple} = 200\text{ mV}_{p-p}$, $T_a = 25^\circ\text{C}$ (Note 4)	$f = 1\text{ kHz}$	—	100	—	—	—	—	dB
			$f = 10\text{ kHz}$	—	93	—	—	—	—	dB
			$f = 100\text{ kHz}$	—	68	—	—	—	—	dB
			$f = 1\text{ MHz}$	—	68	—	—	—	—	dB
Load transient response	ΔV_{OUT}	$I_{OUT} = 1\text{ mA} \rightarrow 300\text{ mA}$, $t_r = 1\text{ }\mu\text{s}$	—	-30	—	—	—	—	mV	
		$I_{OUT} = 300\text{ mA} \rightarrow 1\text{ mA}$, $t_r = 1\text{ }\mu\text{s}$	—	+30	—	—	—	—	mV	
Output voltage slew rate	V_{OUTSR}	(Note 4)	—	4	—	—	—	—	mV/ μs	
Output current limit	I_{CL}	—	—	—	—	400	700	—	mA	
Thermal shutdown threshold	T_{SDH}	T_j rising	—	160	—	—	—	—	$^\circ\text{C}$	
	T_{SDL}	T_j falling	—	140	—	—	—	—	$^\circ\text{C}$	
Control pin threshold voltage	V_{CTH}	Control pin input voltage "HIGH"	—	—	—	1.0	V_{IN}	—	V	
	V_{CTL}	Control pin input voltage "LOW"	—	—	—	0	0.4	—	V	
Discharge on resistance	R_{SD}	(Note 4)	—	20	—	—	—	—	Ω	

Note 3: stable state with fixed I_{OUT} condition

Note 4: $V_{OUT} = 2.8\text{ V}$

Note 5: except Control pull down current (I_{CT})

Note 6: This parameter is warranted by design.

Note 7: $V_{DO} = V_{IN1} - (V_{OUT1} \times 0.97)$

V_{OUT1} is the nominal output voltage.

V_{IN1} is the input voltage at which the output voltage becomes 97% of V_{OUT1} after gradually decreasing the input voltage.

Dropout voltage table ($C_{IN} = 1.0 \mu\text{F}$, $C_{OUT} = 1.0 \mu\text{F}$)

Output voltages	$I_{OUT} = 300 \text{ mA}$			Unit
	Min	Typ.	Max (Note 8)	
$0.9 \text{ V} \leq V_{OUT} \leq 1.5 \text{ V}$	—	(Note 9)	(Note 9)	mV
1.5 V	—	225 (Note 9)	280 (Note 9)	mV
1.6 V	—	210	255	mV
1.7 V	—	190	235	mV
1.8 V, 1.825 V, 1.85 V	—	180	220	mV
1.9 V	—	175	210	mV
2.0 V	—	170	200	mV
2.2 V	—	160	185	mV
2.5 V, 2.6 V	—	140	165	mV
2.7 V	—	130	155	mV
2.8 V	—	130	150	mV
2.85 V, 2.9 V	—	125	150	mV
3.0 V, 3.1 V, 3.2 V	—	120	145	mV
3.3 V	—	115	140	mV
3.5 V, 3.6 V	—	110	140	mV
4.0 V	—	100	138	mV
4.1 V	—	100	135	mV
4.2 V, 4.3 V	—	100	133	mV
4.5 V	—	98	125	mV

Note 8: $T_j = -40$ to $85 \text{ }^\circ\text{C}$. This parameter is guaranteed by design

Note 9: Operating Voltage of V_{IN} should be over 1.8 V.

9. Application Note

9.1. Recommended Application Circuit

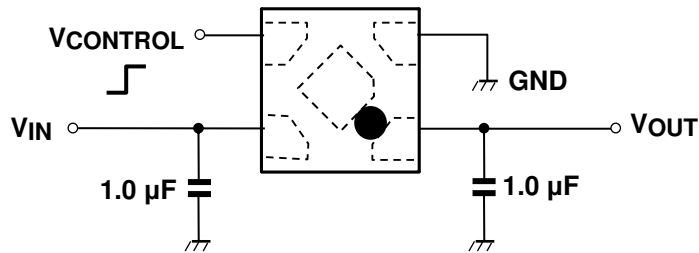

CONTROL voltage	Output voltage
HIGH	ON
LOW	OFF
OPEN	OFF

The figure above shows the recommended configuration for using a Low-Dropout regulator. Insert a capacitor at VOUT and VIN pins for stable input/output operation. (Ceramic capacitors can be used.)

9.2. Power Dissipation

Board-mounted power dissipation ratings for TCR3RM series are available in the Absolute Maximum Ratings table. Power dissipation is measured on the board condition shown below.

[The Board Condition]

Board material: Glass epoxy(FR4)

Board dimension: 40mm x 40mm (both sides of board), t= 1.6 mm

Metal pattern ratio: a surface approximately 50%, the reverse side approximately 50%

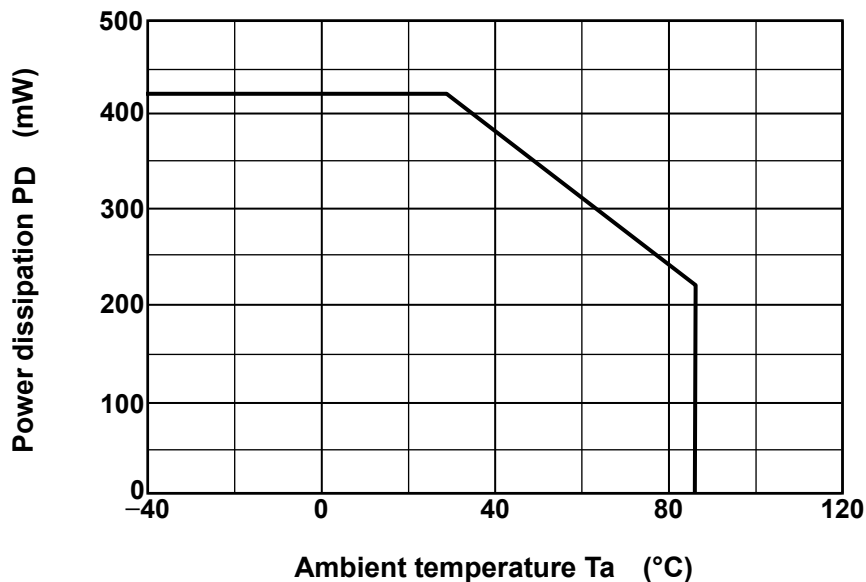

9.3. Attention in Use

- **Output Capacitors**

Ceramic capacitors can be used for these devices. However, because of the type of the capacitors, there might be unexpected thermal features. Please consider application condition for selecting capacitors. And Toshiba recommends ceramic capacitor.
- **Bias current characteristics**

TCR3RM series has Bias current; $I_{B(ON)}$ characteristic that controlled depending on I_{OUT} . When the output current required is very low, TCR3RM series operates with low $I_{B(ON)}$. In this state, PSRR characteristic and load transient response characteristic are inferior than normal characteristics. Regarding output current that switches $I_{B(ON)}$ state, TCR3RM series has hysteresis to control. When output current is increased, good PSRR characteristics and good load transient response characteristics are provided with $I_{B(ON)}$ becoming high. In the case of decreasing the I_{OUT} , TCR3RM series keeps good characteristics until the $I_{B(ON)}$ switches to a low state.
- **Mounting**

The long distance between IC and output capacitor might affect phase compensation by impedance in wire and inductor. For stable power supply, output capacitor need to mount near IC as much as possible. Also V_{IN} and GND pattern need to be large and make the wire impedance small as possible.
- **Permissible Loss**

Please have enough design patterns for expected maximum permissible loss. And under consideration of surrounding temperature, input voltage, output current etc., we recommend proper dissipation ratings for maximum permissible loss; in general maximum dissipation rating is 70 to 80%.
- **Over current Protection and Thermal shutdown function**

Over current protection and Thermal shutdown function are designed in these products, but these are not designed to constantly ensure the suppression of the device within operation limits. Depending on the condition during actual usage, it could affect the electrical characteristic specification and reliability. Also note that if output pins and GND pins are not completely shorted out, these products might be break down. When using these products, please read through and understand the concept of dissipation for absolute maximum ratings from the above mention or our 'Semiconductor Reliability Handbook'. Then use these products under absolute maximum ratings in any condition. Furthermore, Toshiba recommends inserting failsafe system into the design.
- **High ripple rejection ratio and low output noise voltage characteristics**

TCR3RM series has low-pass filter which contributes high ripple rejection ratio and low output noise voltage. This low-pass filter turns on after V_{OUT} becomes near the nominal V_{OUT} . Therefore, before and when the low-pass filter is turned on, please be careful about the increase and decrease of V_{OUT} such as CONTROL voltage from low to high and load transient response. It affects significantly especially when the voltage difference between V_{IN} and V_{OUT} is small.

10. Representative Typical Characteristics

10.1. Output Voltage vs. Output Current ($V_{IN} = V_{OUT} + 1\text{ V}$)

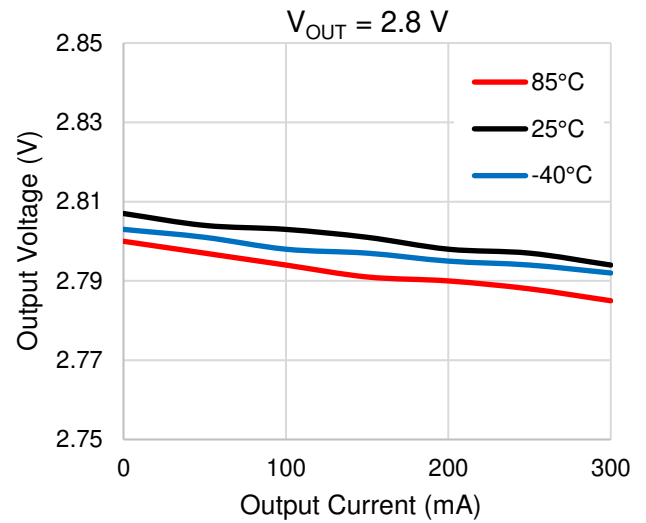
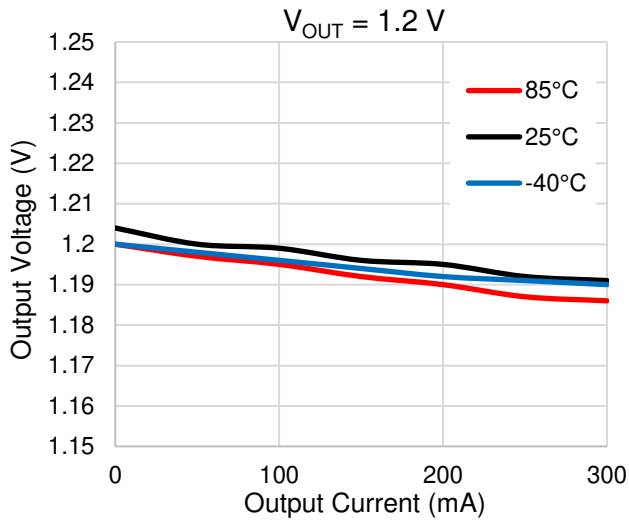

10.2. Dropout Voltage vs. Output Current

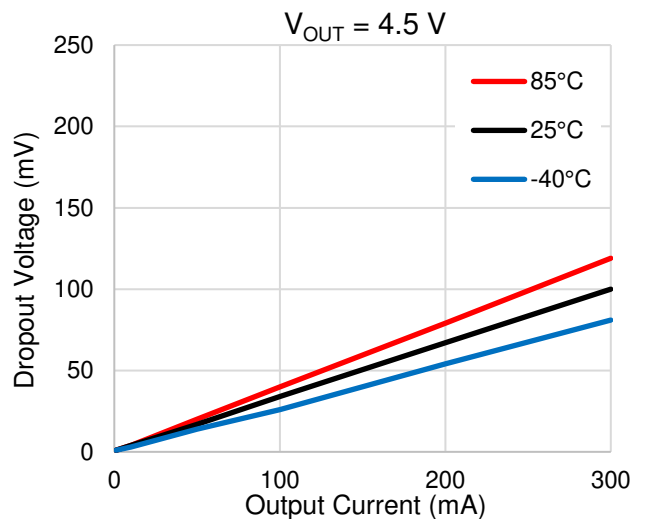
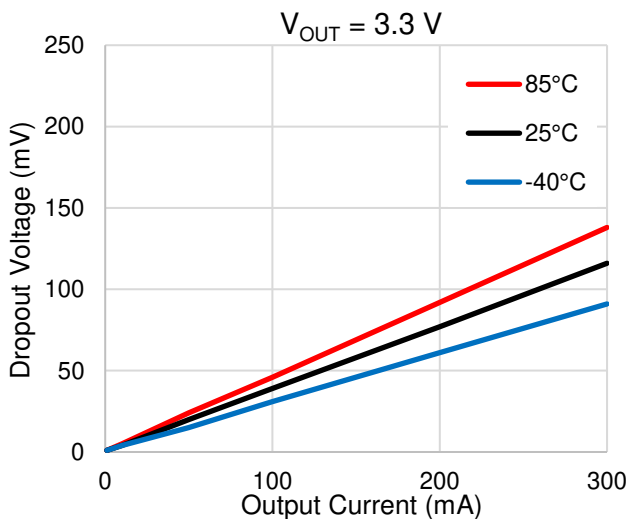
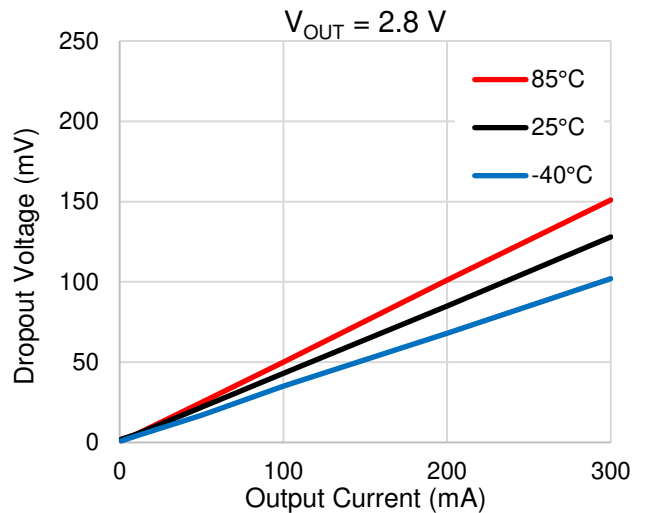
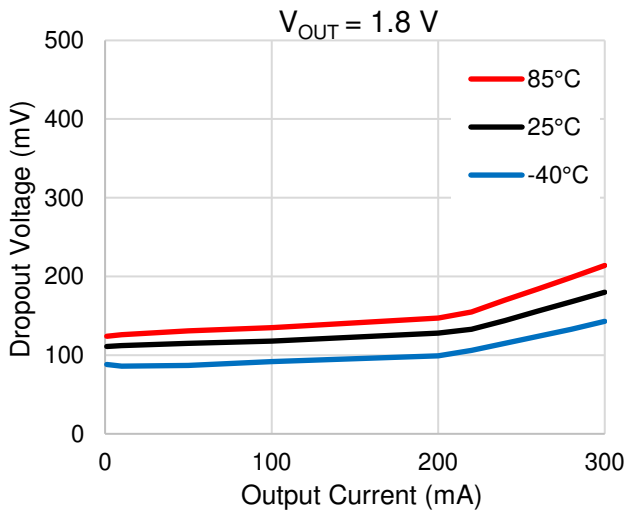

10.3. Quiescent Current vs. Input Voltage ($I_{OUT} = 0mA$)

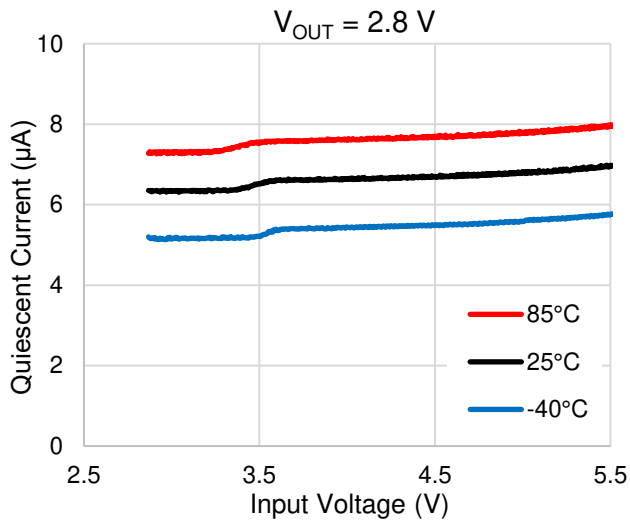
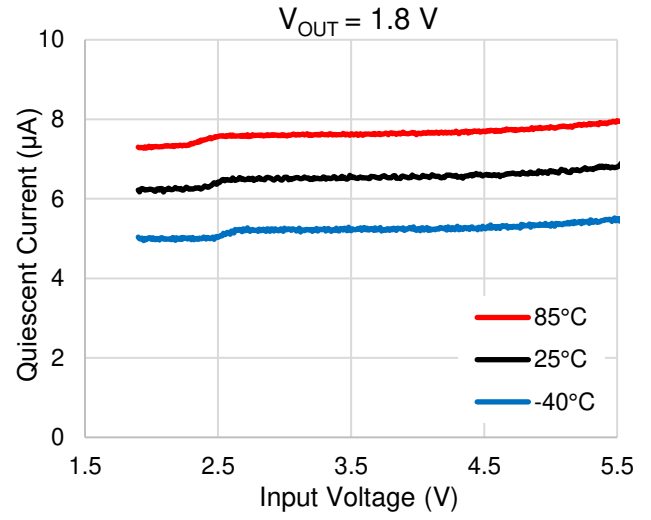
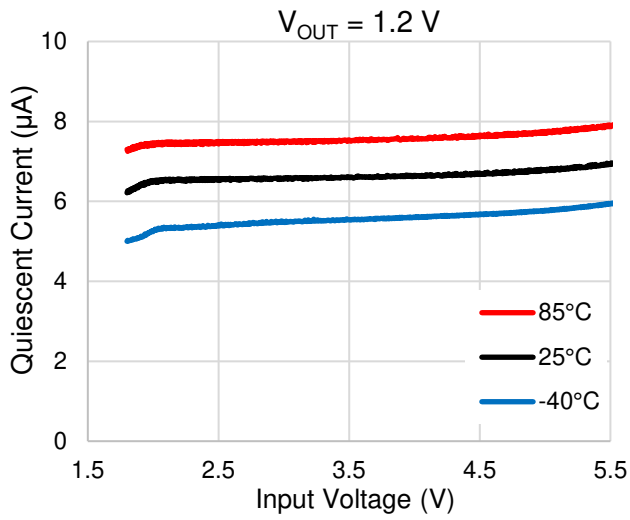

10.4. Quiescent Current vs. Output Current ($V_{IN} = V_{OUT} + 1\text{ V}$, $I_{OUT} = 0 \leftrightarrow 300\ \mu\text{A}$, $T_a=25^\circ\text{C}$)

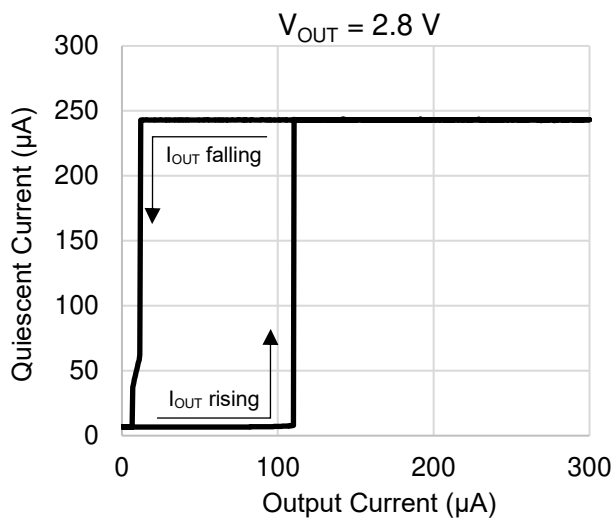
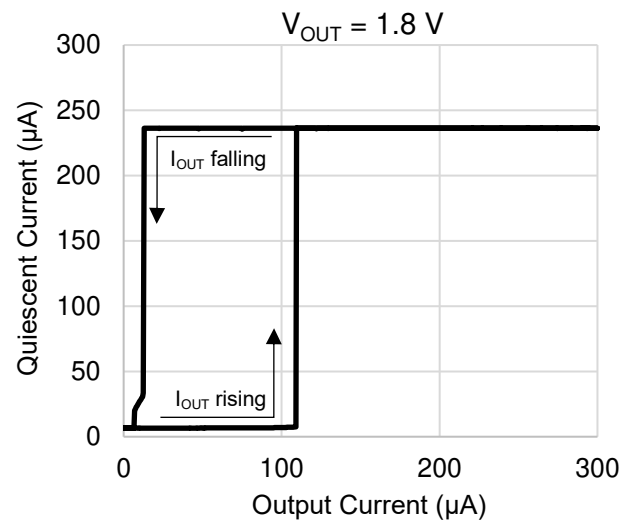
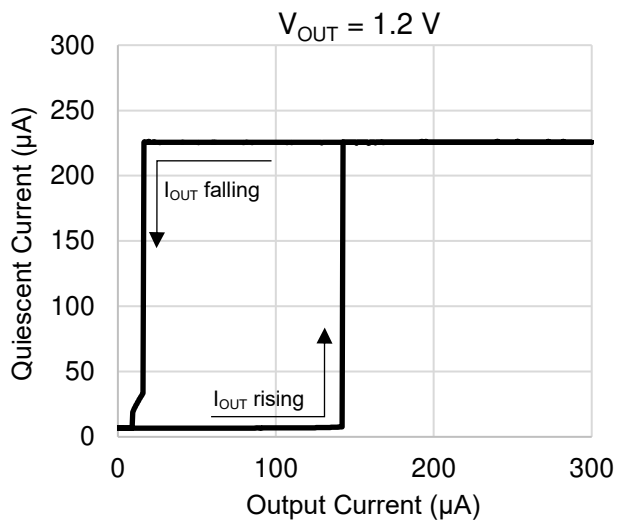

10.5. Output Current Limit ($V_{IN} = V_{OUT} + 1\text{ V}$, $T_a = 25^\circ\text{C}$)

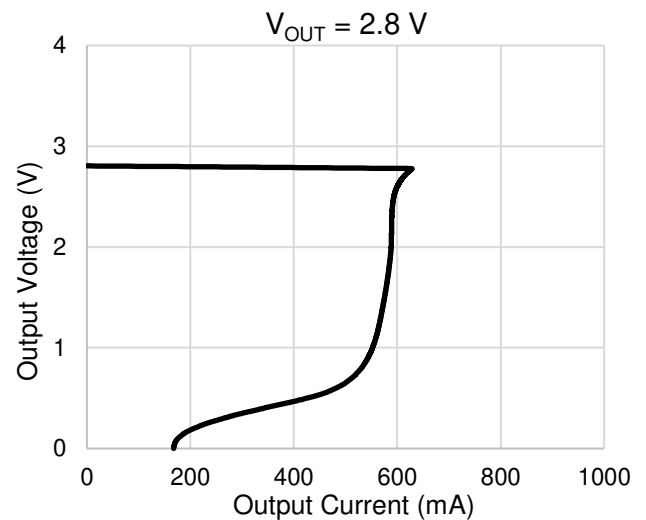
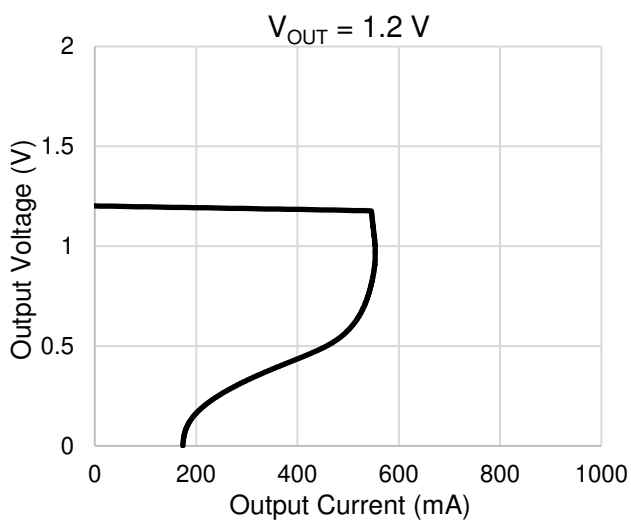

10.6. Ripple rejection Ratio vs. Frequency

(C_{IN} = none, C_{OUT} = 1 μ F, V_{IN} Ripple = 200 mV_{p-p}, I_{OUT} = 10 mA, T_a = 25°C)

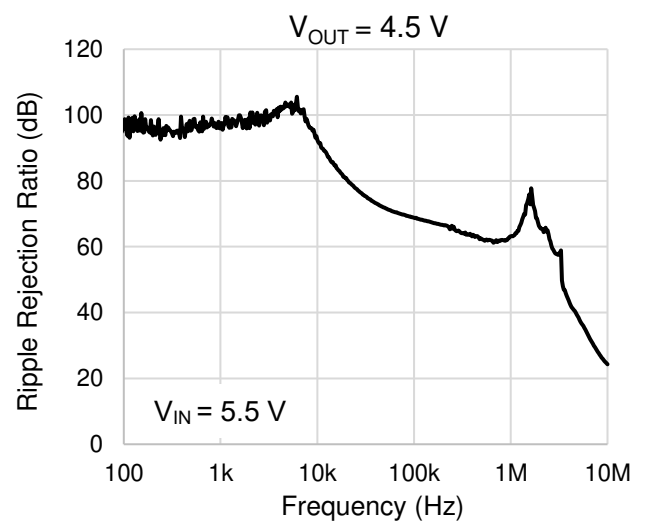
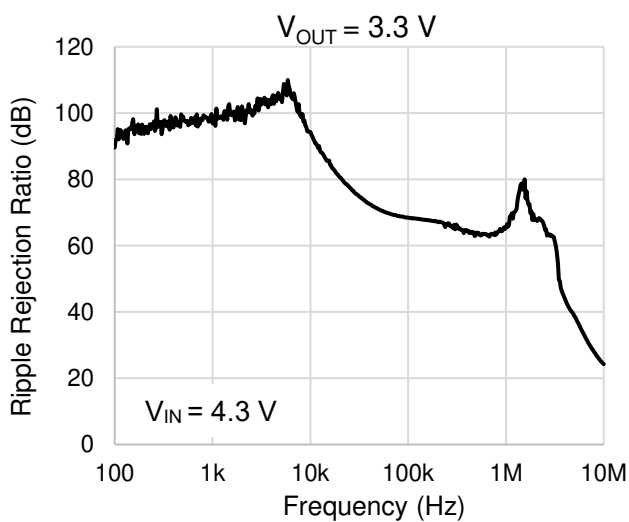
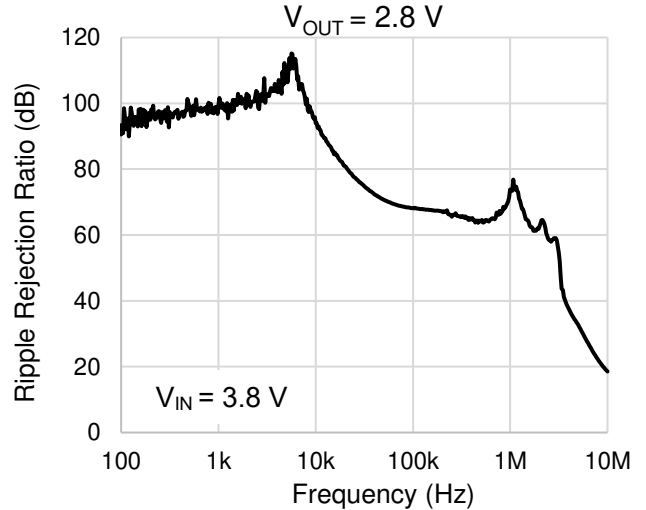
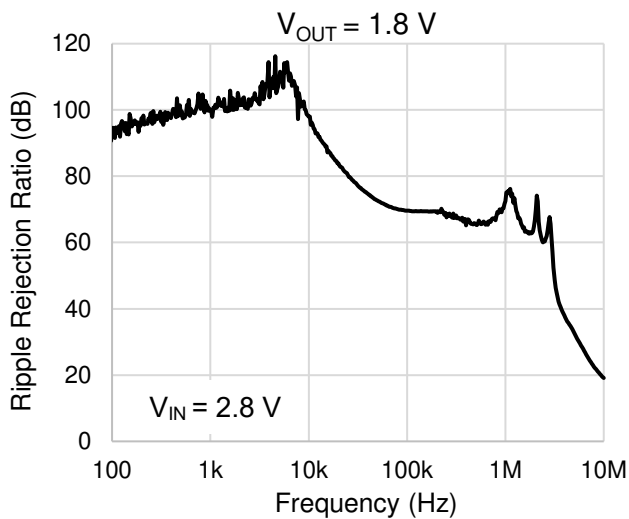
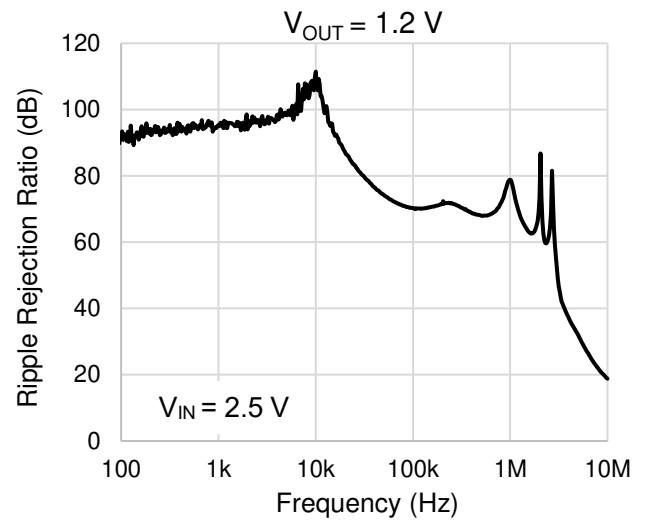
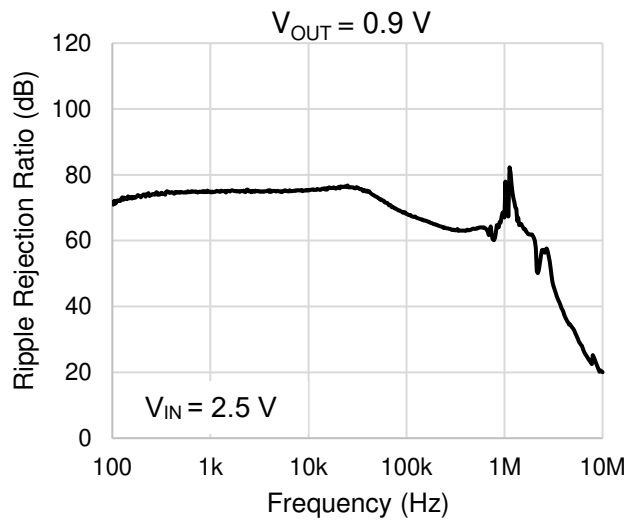

10.7. t_{ON} / t_{OFF} Response ($C_{IN} = 1 \mu F$, $V_{IN} = V_{OUT} + 1 V$, $V_{CONTROL} = 0 V \leftrightarrow 1 V$, $T_a = 25^\circ C$)

- $C_{OUT} = 1 \mu F$, $I_{OUT} = 10 mA$

$V_{OUT} = 1.2 V$

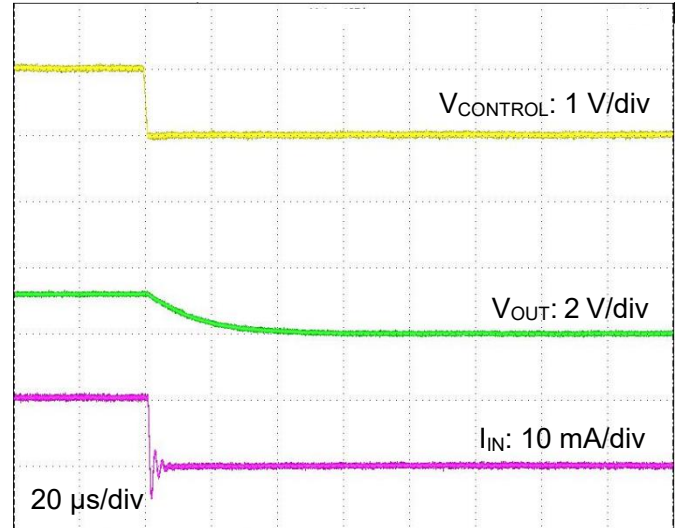
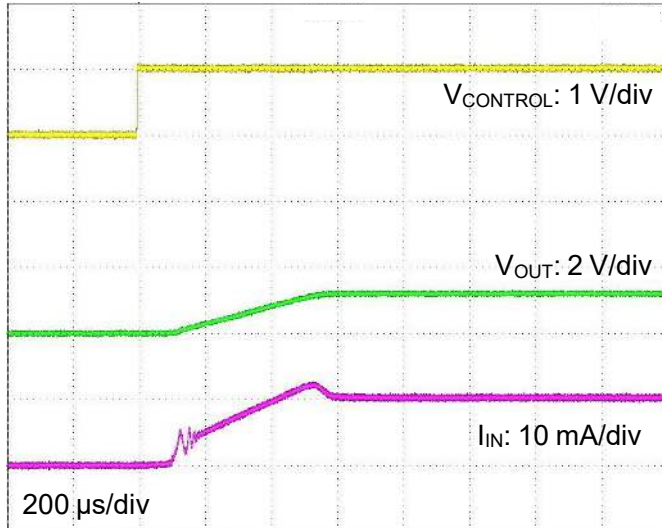

$V_{OUT} = 2.8 V$

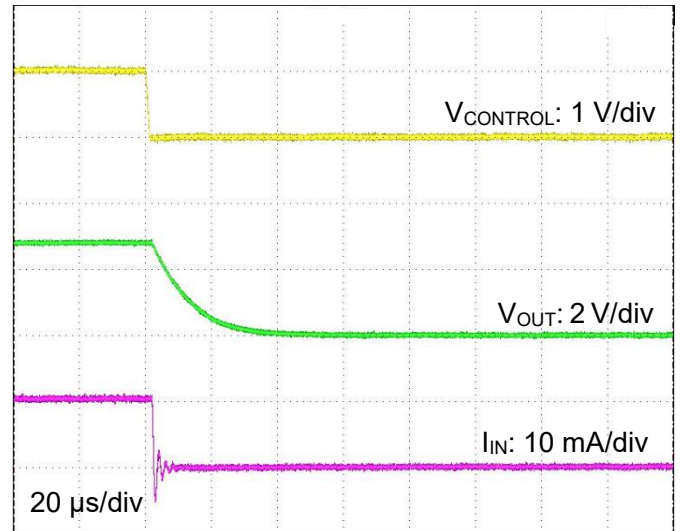
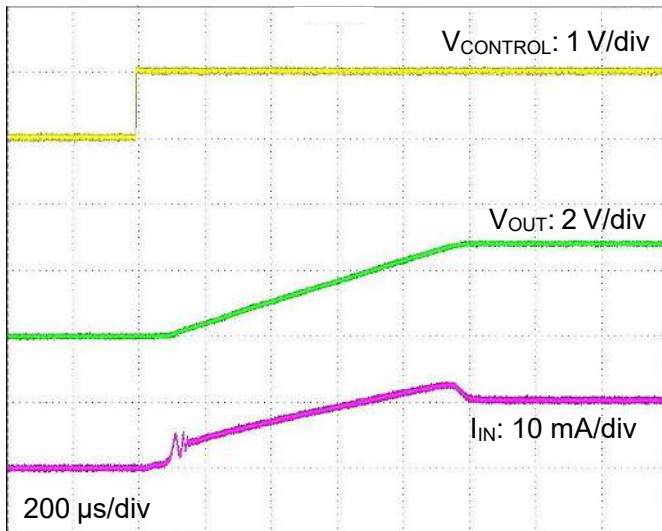

- $C_{OUT} = 1 \mu F$, $I_{OUT} = 300 \text{ mA}$

$V_{OUT} = 1.2 \text{ V}$

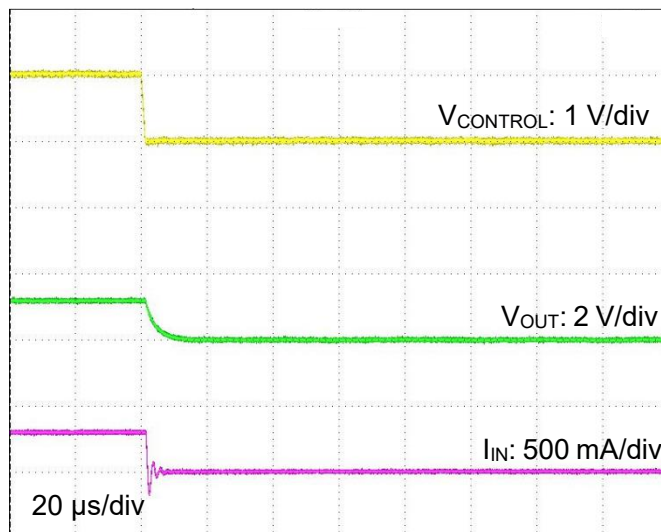
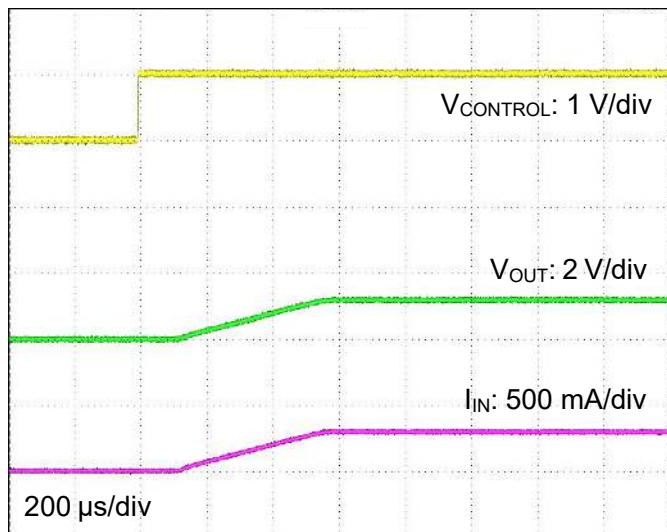

$V_{OUT} = 2.8 \text{ V}$

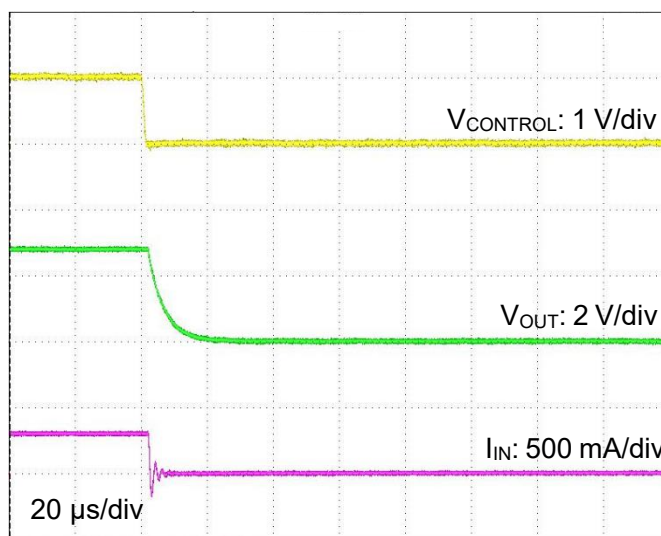
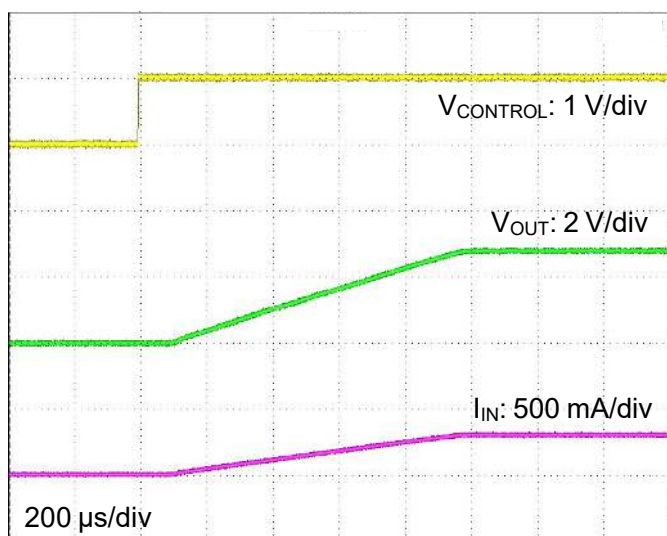

- $C_{OUT} = 10 \mu\text{F}$, $I_{OUT} = 10 \text{ mA}$

$V_{OUT} = 1.2 \text{ V}$

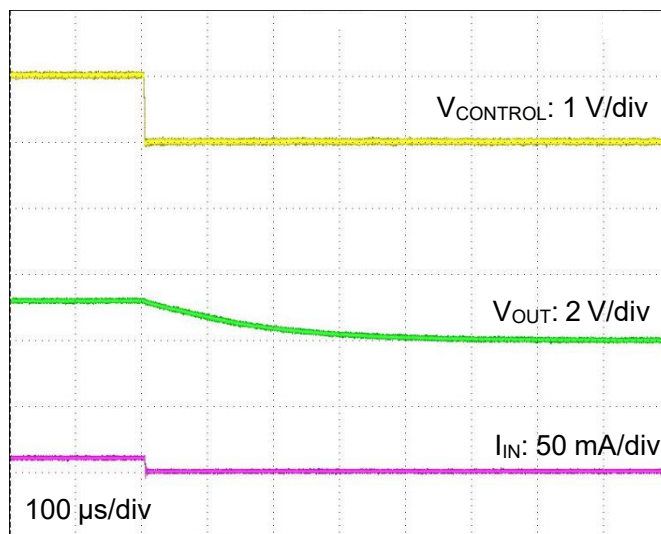
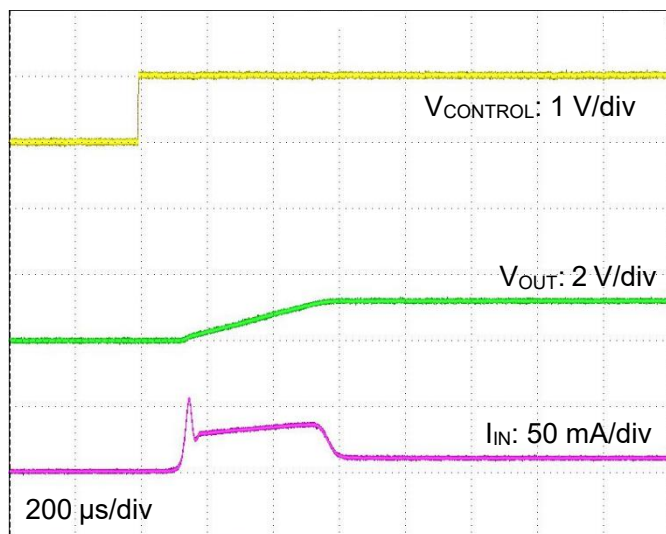

$V_{OUT} = 2.8 \text{ V}$

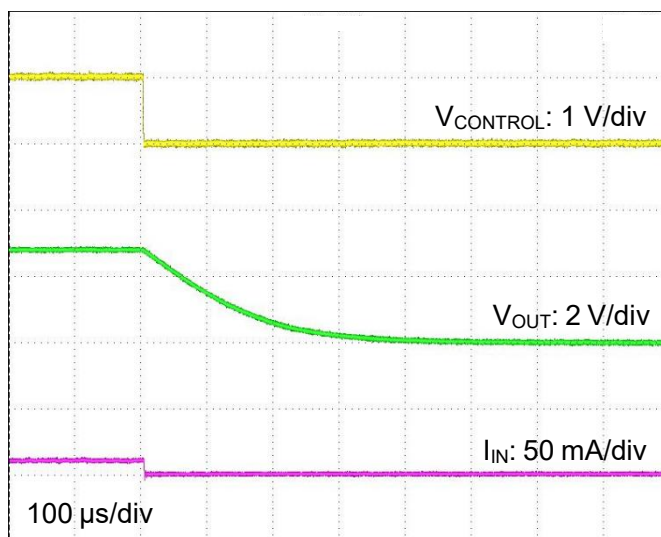
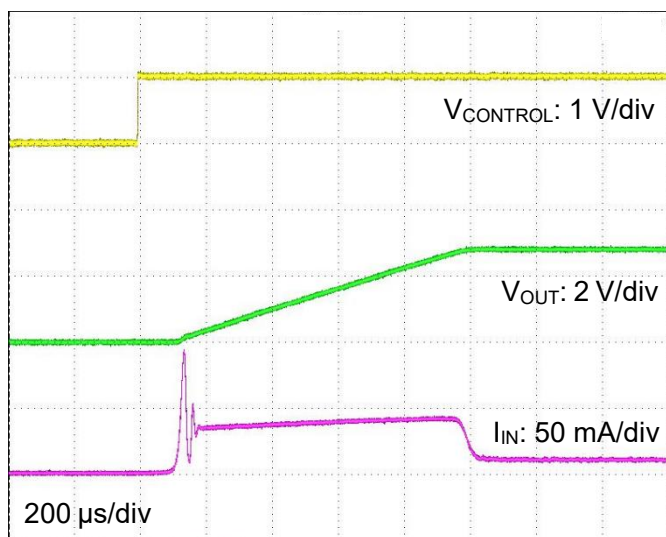

- $C_{OUT} = 10 \mu\text{F}$, $I_{OUT} = 300 \text{ mA}$

$V_{OUT} = 1.2 \text{ V}$

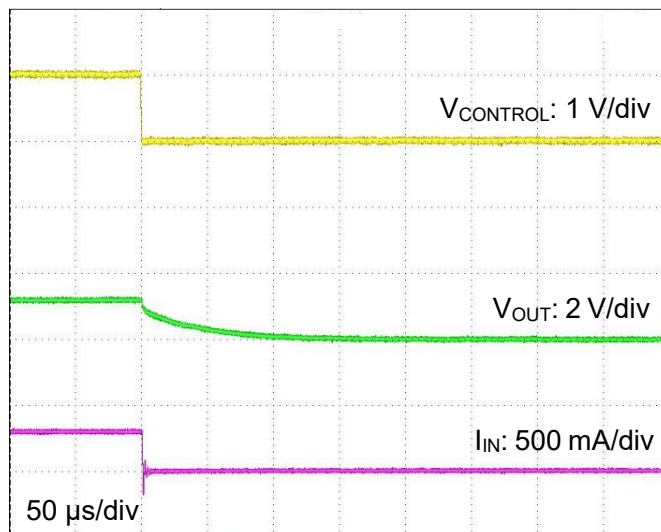
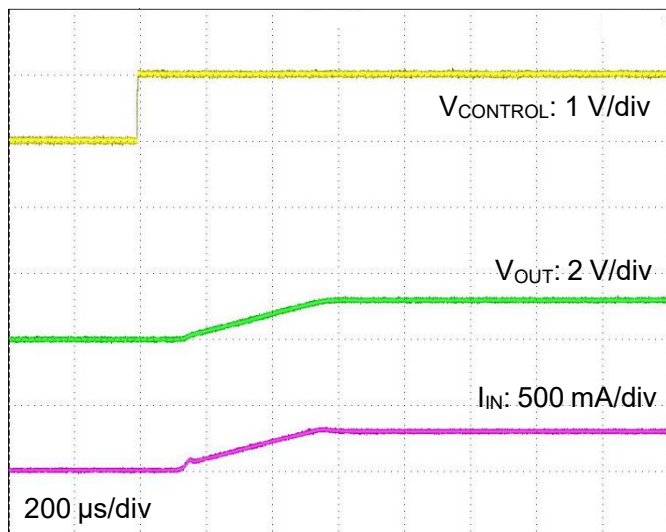

$V_{OUT} = 2.8 \text{ V}$

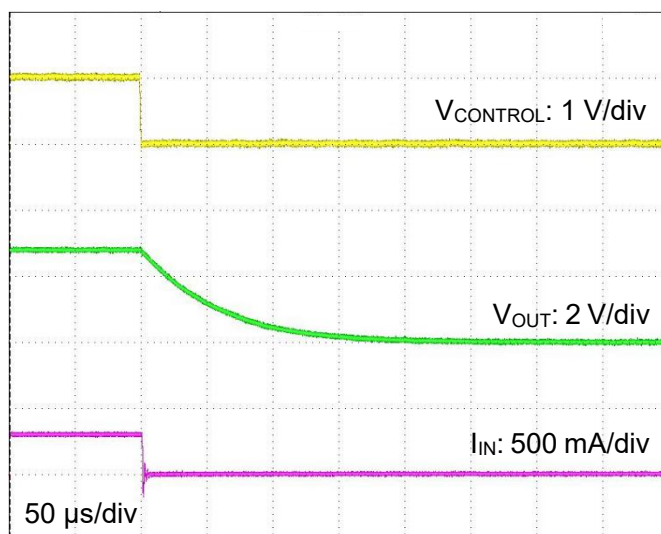
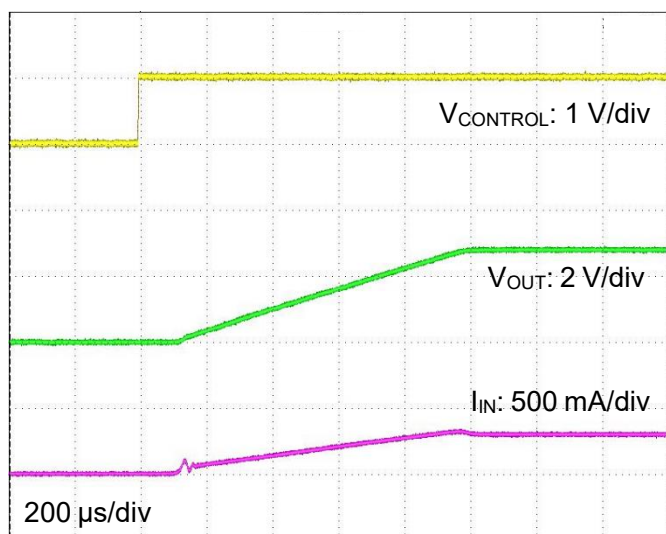

10.8. Load Transient Response

($C_{IN} = 1 \mu F$, $C_{OUT} = 1 \mu F$, $V_{IN} = 3.8 V$, $V_{OUT} = 2.8 V$, $t_r = 1 \mu s$, $t_f = 1 \mu s$, $T_a = 25^\circ C$)

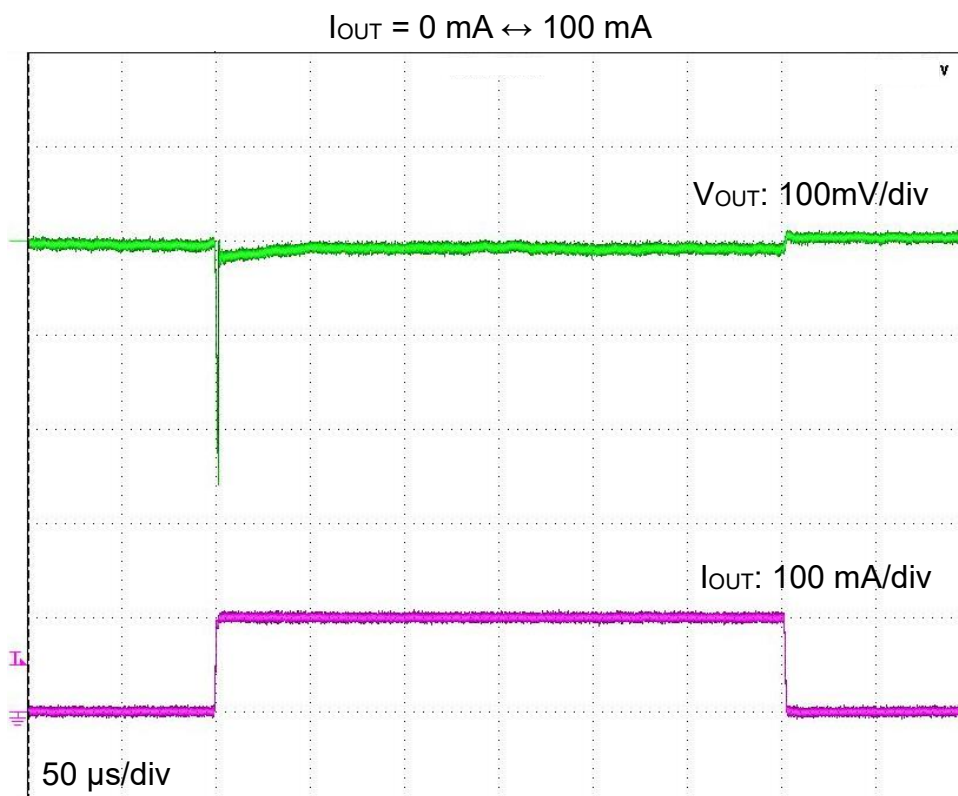
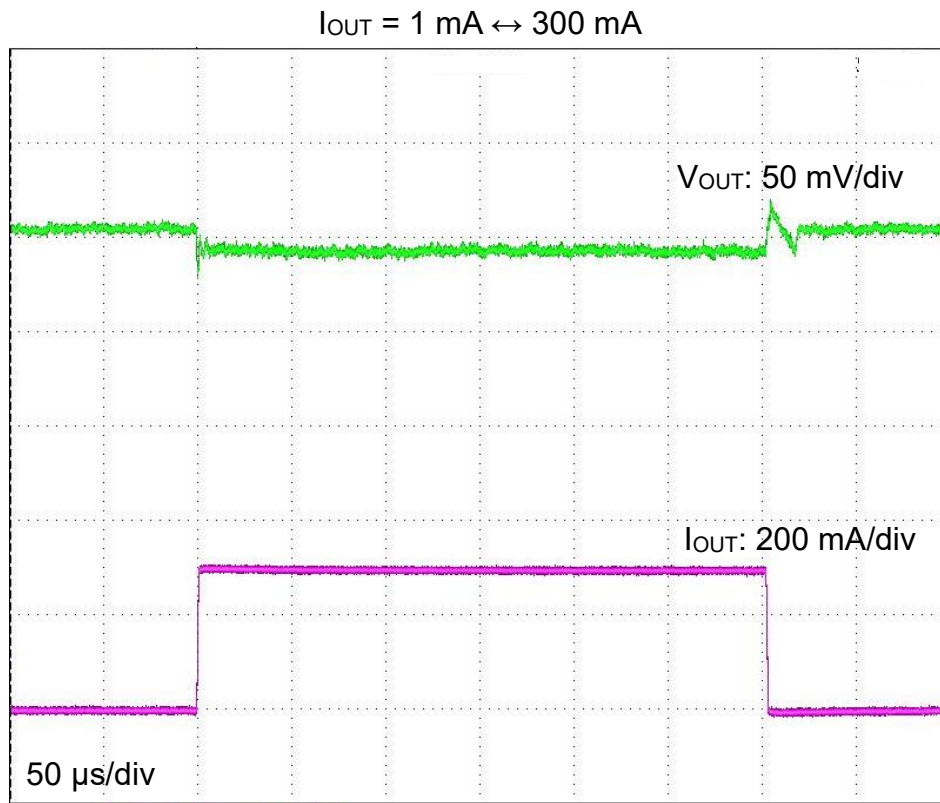

The above characteristics curves are presented for reference only and not guaranteed by production test, unless otherwise noted.

11. Package Information

11.1. DFN4C

Unit : mm

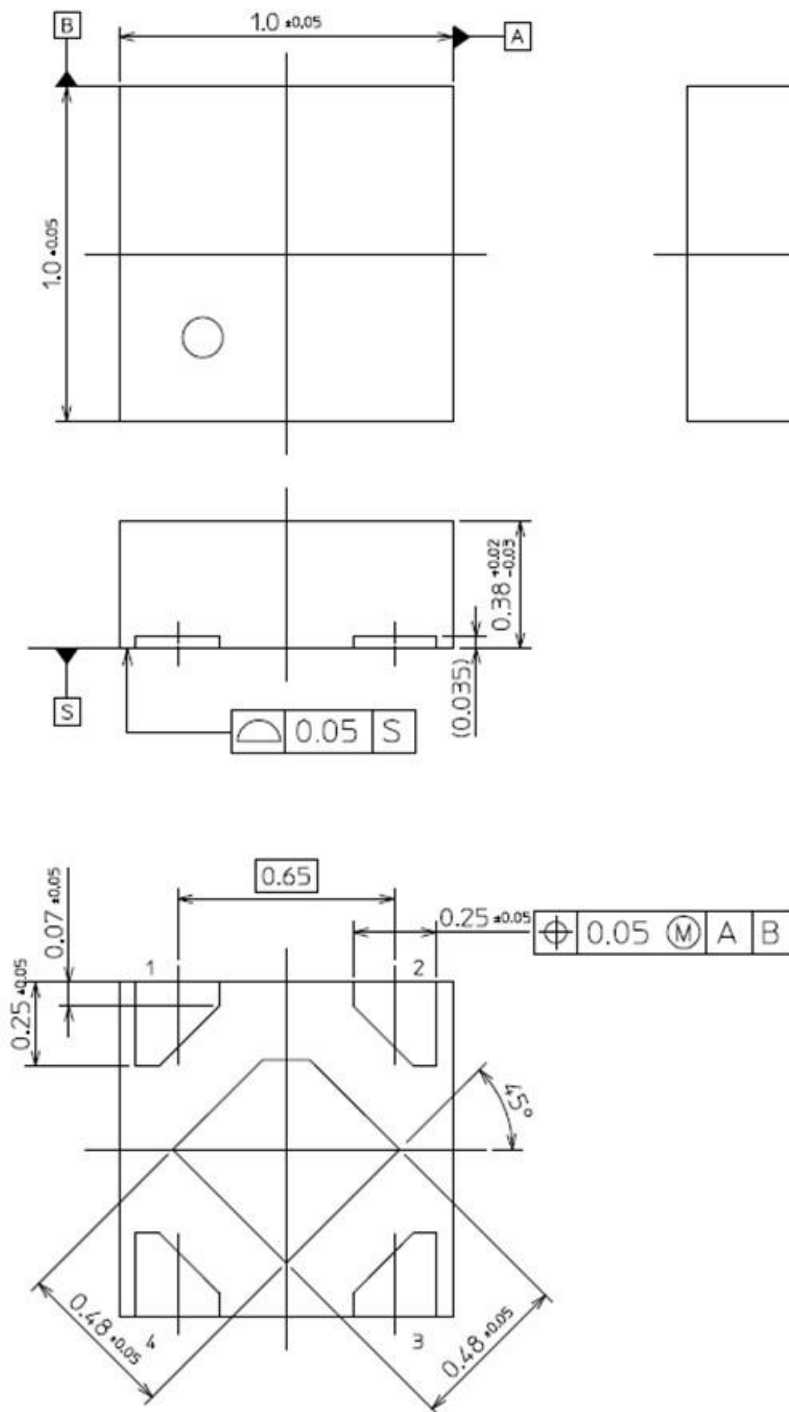

Weight : 0.93 mg (typ.)

Figure 11.1 Package Dimensions

11.2. DFN4F

Unit : mm

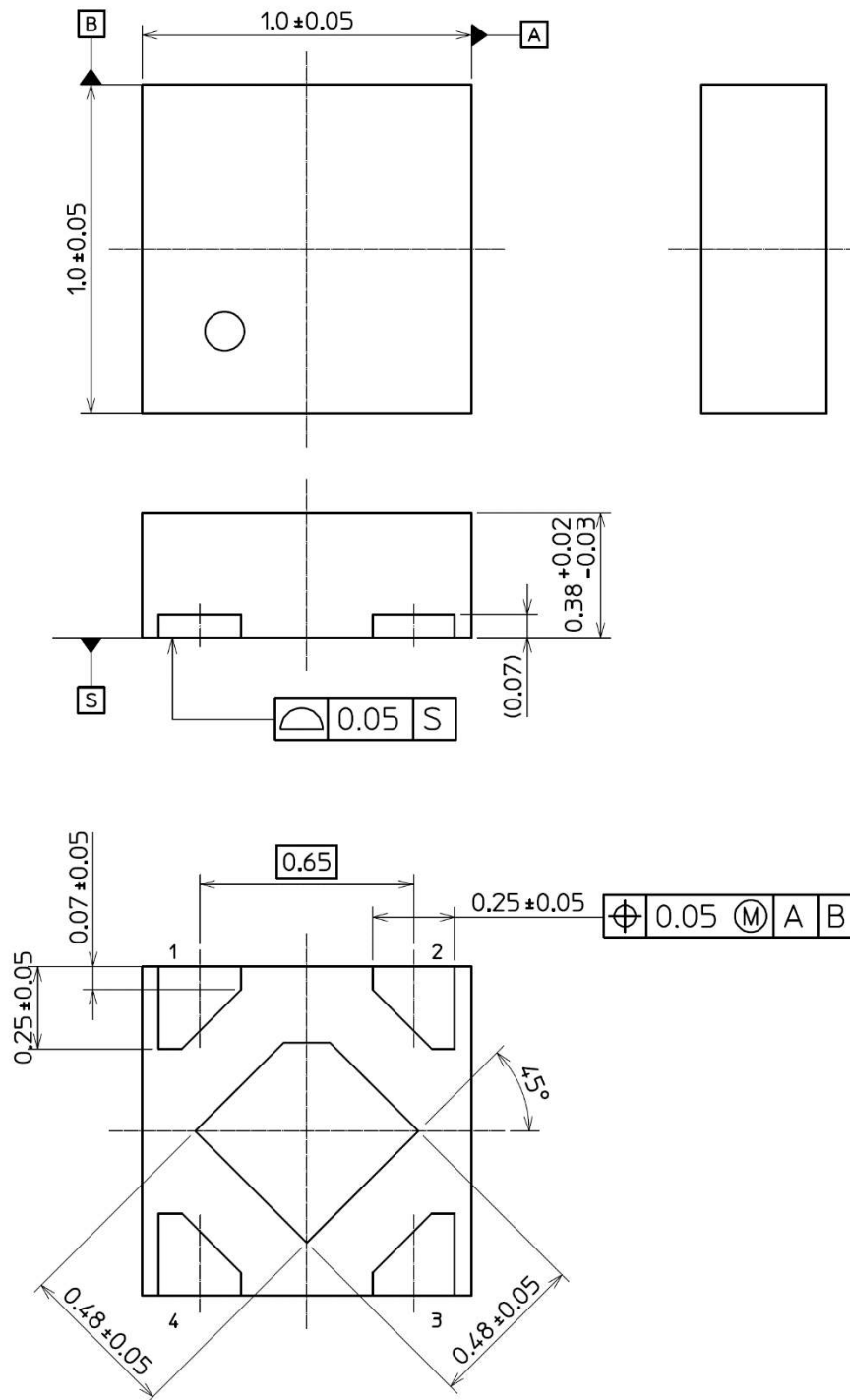

Weight : 0.93 mg (typ.)

Figure 11.2 Package Dimensions

RESTRICTIONS ON PRODUCT USE

Toshiba Corporation and its subsidiaries and affiliates are collectively referred to as "TOSHIBA". Hardware, software and systems described in this document are collectively referred to as "Product".

- TOSHIBA reserves the right to make changes to the information in this document and related Product without notice.
- This document and any information herein may not be reproduced without prior written permission from TOSHIBA. Even with TOSHIBA's written permission, reproduction is permissible only if reproduction is without alteration/omission.
- Though TOSHIBA works continually to improve Product's quality and reliability, Product can malfunction or fail. Customers are responsible for complying with safety standards and for providing adequate designs and safeguards for their hardware, software and systems which minimize risk and avoid situations in which a malfunction or failure of Product could cause loss of human life, bodily injury or damage to property, including data loss or corruption. Before customers use the Product, create designs including the Product, or incorporate the Product into their own applications, customers must also refer to and comply with (a) the latest versions of all relevant TOSHIBA information, including without limitation, this document, the specifications, the data sheets and application notes for Product and the precautions and conditions set forth in the "TOSHIBA Semiconductor Reliability Handbook" and (b) the instructions for the application with which the Product will be used with or for. Customers are solely responsible for all aspects of their own product design or applications, including but not limited to (a) determining the appropriateness of the use of this Product in such design or applications; (b) evaluating and determining the applicability of any information contained in this document, or in charts, diagrams, programs, algorithms, sample application circuits, or any other referenced documents; and (c) validating all operating parameters for such designs and applications. **TOSHIBA ASSUMES NO LIABILITY FOR CUSTOMERS' PRODUCT DESIGN OR APPLICATIONS.**
- **PRODUCT IS NEITHER INTENDED NOR WARRANTED FOR USE IN EQUIPMENTS OR SYSTEMS THAT REQUIRE EXTRAORDINARILY HIGH LEVELS OF QUALITY AND/OR RELIABILITY, AND/OR A MALFUNCTION OR FAILURE OF WHICH MAY CAUSE LOSS OF HUMAN LIFE, BODILY INJURY, SERIOUS PROPERTY DAMAGE AND/OR SERIOUS PUBLIC IMPACT ("UNINTENDED USE").** Except for specific applications as expressly stated in this document, Unintended Use includes, without limitation, equipment used in nuclear facilities, equipment used in the aerospace industry, lifesaving and/or life supporting medical equipment, equipment used for automobiles, trains, ships and other transportation, traffic signaling equipment, equipment used to control combustions or explosions, safety devices, elevators and escalators, and devices related to power plant. **IF YOU USE PRODUCT FOR UNINTENDED USE, TOSHIBA ASSUMES NO LIABILITY FOR PRODUCT.** For details, please contact your TOSHIBA sales representative or contact us via our website.
- Do not disassemble, analyze, reverse-engineer, alter, modify, translate or copy Product, whether in whole or in part.
- Product shall not be used for or incorporated into any products or systems whose manufacture, use, or sale is prohibited under any applicable laws or regulations.
- The information contained herein is presented only as guidance for Product use. No responsibility is assumed by TOSHIBA for any infringement of patents or any other intellectual property rights of third parties that may result from the use of Product. No license to any intellectual property right is granted by this document, whether express or implied, by estoppel or otherwise.
- **ABSENT A WRITTEN SIGNED AGREEMENT, EXCEPT AS PROVIDED IN THE RELEVANT TERMS AND CONDITIONS OF SALE FOR PRODUCT, AND TO THE MAXIMUM EXTENT ALLOWABLE BY LAW, TOSHIBA (1) ASSUMES NO LIABILITY WHATSOEVER, INCLUDING WITHOUT LIMITATION, INDIRECT, CONSEQUENTIAL, SPECIAL, OR INCIDENTAL DAMAGES OR LOSS, INCLUDING WITHOUT LIMITATION, LOSS OF PROFITS, LOSS OF OPPORTUNITIES, BUSINESS INTERRUPTION AND LOSS OF DATA, AND (2) DISCLAIMS ANY AND ALL EXPRESS OR IMPLIED WARRANTIES AND CONDITIONS RELATED TO SALE, USE OF PRODUCT, OR INFORMATION, INCLUDING WARRANTIES OR CONDITIONS OF MERCHANTABILITY, FITNESS FOR A PARTICULAR PURPOSE, ACCURACY OF INFORMATION, OR NONINFRINGEMENT.**
- Do not use or otherwise make available Product or related software or technology for any military purposes, including without limitation, for the design, development, use, stockpiling or manufacturing of nuclear, chemical, or biological weapons or missile technology products (mass destruction weapons). Product and related software and technology may be controlled under the applicable export laws and regulations including, without limitation, the Japanese Foreign Exchange and Foreign Trade Law and the U.S. Export Administration Regulations. Export and re-export of Product or related software or technology are strictly prohibited except in compliance with all applicable export laws and regulations.
- Please contact your TOSHIBA sales representative for details as to environmental matters such as the RoHS compatibility of Product. Please use Product in compliance with all applicable laws and regulations that regulate the inclusion or use of controlled substances, including without limitation, the EU RoHS Directive. **TOSHIBA ASSUMES NO LIABILITY FOR DAMAGES OR LOSSES OCCURRING AS A RESULT OF NONCOMPLIANCE WITH APPLICABLE LAWS AND REGULATIONS.**