

# High Temperature (230 °C) Wirebondable Thin Film Chip Resistors and Resistor Networks

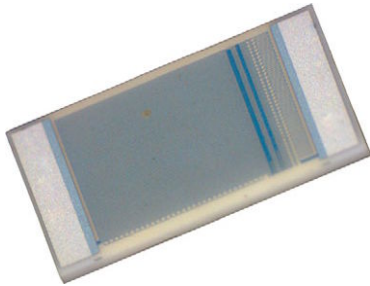

## LINKS TO ADDITIONAL RESOURCES



## INTRODUCTION

For applications such as down hole applications, the need for parts able to withstand very severe conditions (temperature as high as 215 °C powered or up to 230 °C un-powered) has led Vishay Sfernice to push out the limit of the thin film technology.

Designers might read the application note “Power Dissipation Considerations in High Precision Vishay Sfernice Thin Film Chip Resistors and Arrays (P, PRA, etc...) (High Temperature Application)” [www.vishay.com/doc?53047](http://www.vishay.com/doc?53047) in conjunction with this datasheet to help them to properly design their PCBs and get the best performances of the RMKHT.

Vishay Sfernice research and development engineers will be willing to support any customer design considerations.

## FEATURES

- Operating temperature range: -55 °C; +215 °C
- Storage temperature: -55 °C; +230 °C
- Wirebondable (aluminum pads)
- Aluminum pads
- Large selection of sizes available
- Custom networks available on request (CNHT)
- Temperature coefficient down to  $\pm 15$  ppm/°C (-55 °C; +215 °C)
- Tolerance down to  $\pm 0.05$  %
- Temperature coefficient remains at  $\pm 15$  ppm/°C after long term storage at 230 °C
- Material categorization: for definitions of compliance please see [www.vishay.com/doc?99912](http://www.vishay.com/doc?99912)



## TYPICAL PERFORMANCE

	ABS	TRACKING <sup>(1)</sup>
<b>TCR</b>	$\pm 25$ ppm/°C	<b>2</b> ppm/°C
	ABS	RATIO <sup>(1)</sup>
<b>TOL.</b>	$\pm 0.05$ %	<b>0.02</b> %

### Note

(1) When applicable (networks only)

## MECHANICAL SPECIFICATIONS

<b>Resistive element</b>	Nichrome (NiCr)
<b>Substrate material</b>	Silicon (size 22, 33, 55, 515) - alumina (other sizes)
<b>Bonding pads</b>	Aluminum (Al)
<b>Passivation</b>	Silicon nitride (Si <sub>3</sub> N <sub>4</sub> )
<b>Back metallization <sup>(1)</sup></b>	Gold (thickness = 0.5 $\mu$ m typical) on nickel barrier (1 $\mu$ m typical)

### Note

(1) When applicable (only on alumina substrate)

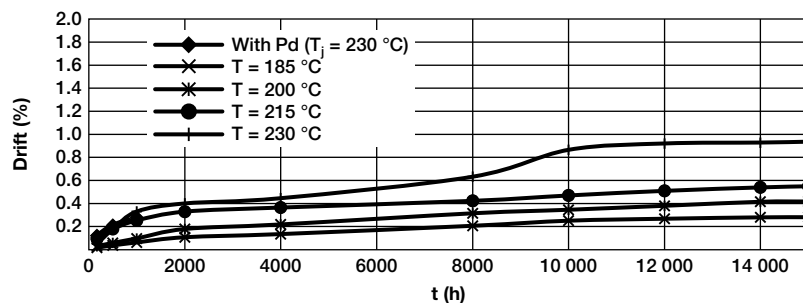

### Note

- TCR (-55 °C; +215 °C) remains unchanged after 15 000 h storage

## SCHEMATIC

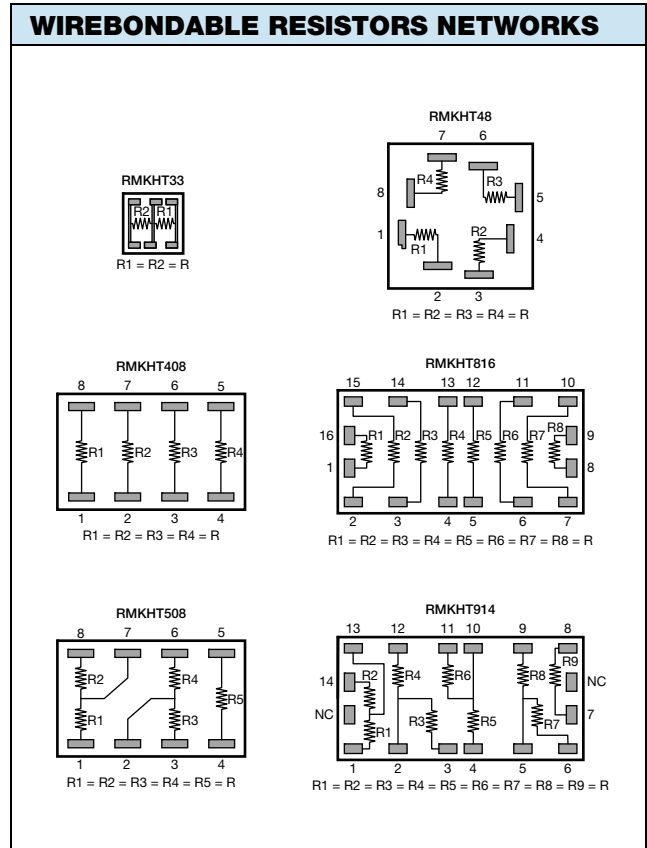
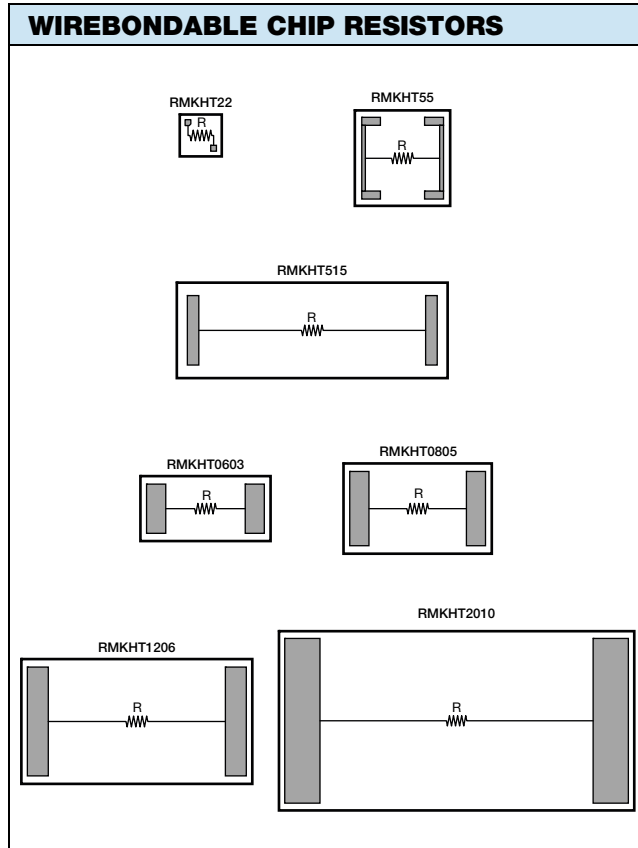

## POWER DERATING CURVE

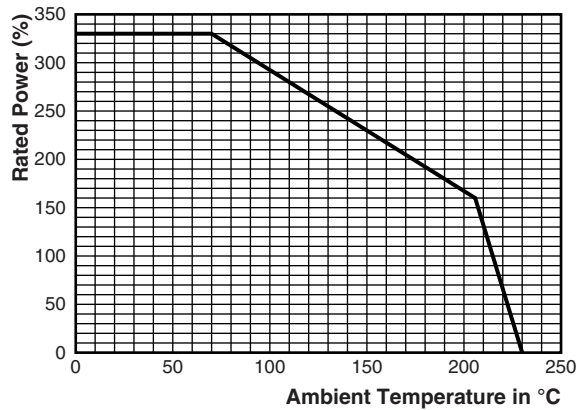

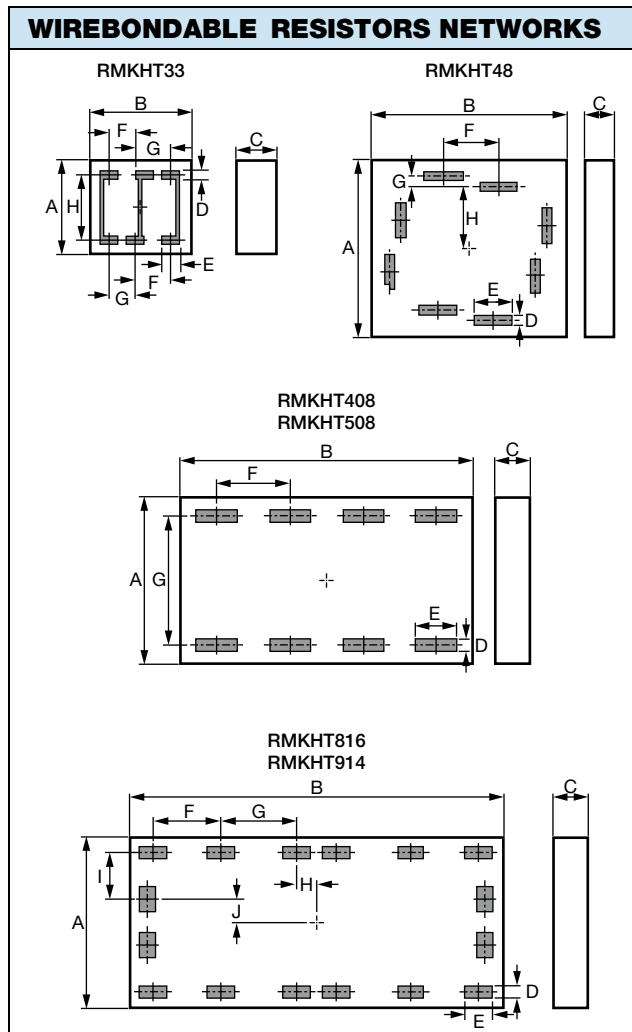
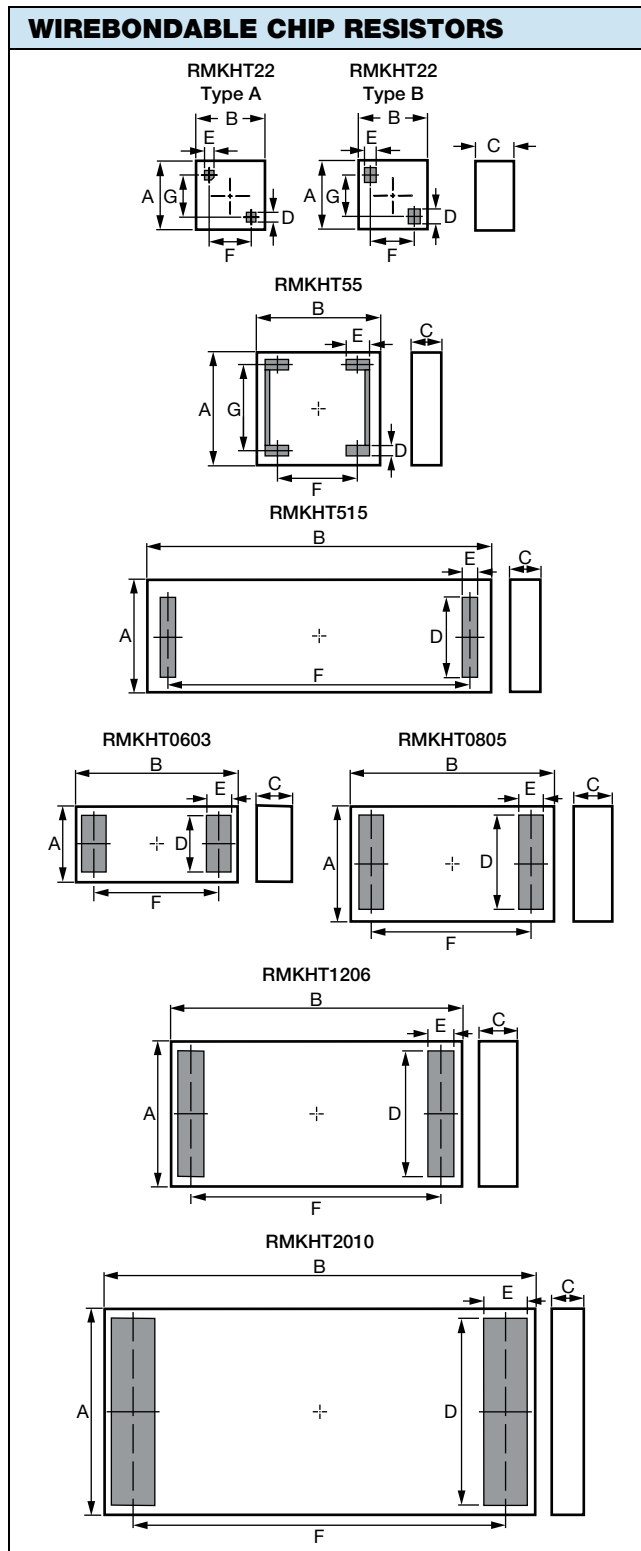
**PATTERN**

**DIMENSIONS in millimeters**

SERIES	A ± 0.05	B ± 0.05	C max.	D	E	F	G
RMKHT22 Type A	0.58	0.58	0.4	0.08	0.08	0.354	0.354
RMKHT22 Type B	0.58	0.58	0.4	0.125	0.1	0.374	0.349
RMKHT55	1.32	1.32	0.4	0.11	0.26	0.87	1.02
RMKHT515	1.32	3.75	0.4	0.96	0.16	3.3	
RMKHT0603	0.9	1.8	0.45	0.68	0.265	1.365	
RMKHT0805	1.25	2.05	0.45	1.03	0.265	1.615	
RMKHT1206	1.725	3.2	0.45	1.505	0.29	2.74	
RMKHT2010	2.64	5.23	0.45	2.42	0.518	4.54	

**DIMENSIONS in millimeters**

SERIES	A ± 0.05	B ± 0.05	C max.	D	E	F	G	H	I	J
RMKHT33	0.83	0.83	0.4	0.08	0.16	0.3	0.22	0.6		
RMKHT48	2	2	0.4	0.1	0.39	0.57	0.12	0.69		
RMKHT408	1.6	2.6	0.4	0.11	0.36	0.65	1.25			
RMKHT508										
RMKHT816	1.7	3.4	0.4	0.13	0.25	0.62	0.69	0.175	0.47	0.225
RMKHT914										

**STANDARD ELECTRICAL SPECIFICATIONS - Bare Resistors Chips**

MODEL	SIZE	RESISTANCE RANGE <sup>(1)</sup> Ω	TCR <sup>(2)</sup> -55 °C; +215 °C ± ppm/°C	TOLERANCE ± %	POWER RATING <sup>(3)</sup> P <sub>70 °C</sub> W	POWER RATING <sup>(3)</sup> P <sub>215 °C</sub> W
RMKHT22	0202	10 to 500K	15, 30	0.05, 0.1, 0.5, 1	0.05	0.005
RMKHT55	0505	150 to 2M	15, 30	0.05, 0.1, 0.5, 1	0.25	0.025
RMKHT515	0515	100 to 5M	15, 30	0.05, 0.1, 0.5, 1	0.5	0.05
RMKHT0603	0603	10 to 320K	15, 30	0.05, 0.1, 0.5, 1	0.125	0.0375
RMKHT0805	0805	10 to 720K	15, 30	0.05, 0.1, 0.5, 1	0.2	0.06
RMKHT1206	1206	10 to 2.7M	15, 30	0.05, 0.1, 0.5, 1	0.33	0.1
RMKHT2010	2010	10 to 7.5M	15, 30	0.05, 0.1, 0.5, 1	1	0.2 <sup>(5)</sup>

**PERFORMANCES - Bare Resistors Chips**

TEST	SPECIFICATIONS	CONDITIONS
Limiting voltage	From 75 V to 300 V (depending on size) <sup>(4)</sup>	
Operating temperature range	-55 °C; +215 °C	
Max. temperature resistive element	220 °C	
Max. substrate temperature	230 °C	
Load life stability	± 0.35 %	2000 h / 220 °C (ambient) at Pn
Storage temperature range	-55 °C; +230 °C	
Shelf life stability	± 0.6 % typ. (± 0.8 % max.)	15 000 h / 230 °C

**STANDARD ELECTRICAL SPECIFICATIONS - Bare Resistors Networks**

MODEL	SIZE	RESISTANCE RANGE <sup>(1)</sup> Ω	ABSOLUTE TOLERANCE ± %	RATIO TOLERANCE ± %	ABSOLUTE TCR <sup>(2)</sup> -55 °C; +215 °C ± ppm/°C	RATIO TCR -55 °C; +215 °C ± ppm/°C	POWER RATING <sup>(3)</sup> P <sub>70 °C</sub> W PER RESISTOR	POWER RATING <sup>(3)</sup> P <sub>215 °C</sub> W PER RESISTOR
RMKHT33	0303	100 to 500K	0.05, 0.1, 0.5, 1	0.02, 0.05, 0.5, 0.1	15, 30	2, 5	0.10	0.010
RMKHT48	0808	100 to 800K	0.05, 0.1, 0.5, 1	0.02, 0.05, 0.5, 0.1	15, 30	2, 5	0.10	0.010
RMKHT408	0610	100 to 400K	0.05, 0.1, 0.5, 1	0.02, 0.05, 0.5, 0.1	15, 30	2, 5	0.10	0.010
RMKHT508	0610	500 to 400K	0.05, 0.1, 0.5, 1	0.02, 0.05, 0.5, 0.1	15, 30	2, 5	0.10	0.010
RMKHT816	0714	100 to 400K	0.05, 0.1, 0.5, 1	0.02, 0.05, 0.5, 0.1	15, 30	2, 5	0.10	0.010
RMKHT914	0714	500 to 200K	0.05, 0.1, 0.5, 1	0.02, 0.05, 0.5, 0.1	15, 30	2, 5	0.10	0.010

**PERFORMANCES - Bare Resistors Networks**

TEST	SPECIFICATIONS	CONDITIONS
Limiting voltage	100 V on each resistor (except RMKHT33 50 V on each resistor)	
Operating temperature range	-55 °C; +215 °C	
Max. temperature resistive element	220 °C	
Max. substrate temperature	230 °C	
Load life stability	± 0.35 %	2000 h / 220 °C (ambient) at Pn
Load life stability on ratio	± 0.35 %	2000 h / 220 °C (ambient) at Pn
Storage temperature range	-55 °C; +230 °C	
Shelf life stability	± 0.6 % typ. (± 0.8 % max.)	15 000 h/230 °C

**Notes**

(1) For ohmic range vs. tolerance and TCR see detailed table on next page.

**(2) Temperature Coefficient of Resistance****Bare Resistors Chips**

Y	± 10 ppm/°C	-55 °C; +155 °C
	± 15 ppm/°C	-55 °C; +215 °C
E	± 25 ppm/°C	-55 °C; +155 °C
	± 30 ppm/°C	-55 °C; +215 °C

**Bare Resistors Networks**

Y	± 10 ppm/°C abs.	1 ppm/°C tracking	-55 °C; +155 °C
	± 15 ppm/°C abs.	2 ppm/°C tracking	-55 °C; +215 °C
E	± 25 ppm/°C abs.	2 ppm/°C tracking	-55 °C; +155 °C
	± 30 ppm/°C abs.	5 ppm/°C tracking	-55 °C; +215 °C

(3) Pn is intended with no back side metallized. For power handling improvement, please refer to application note 53047 "Power Dissipation Considerations in High Precision Vishay Sfernice Thin Film Chip Resistors and Arrays (High Temperature Applications)" [www.vishay.com/doc?53047](http://www.vishay.com/doc?53047) and consult Vishay Sfernice.

(4) See Limiting Voltage table on next page.

(5) It is possible to dissipate up to 0.3 W, but there will be an additional drift of 0.1 % after load life.



<b>BEST TOLERANCE AND TCR VS. OHMIC VALUE - Bare Resistors Chips</b>				
SERIES	OHMIC RANGE <sup>(1)</sup>			
	CT: Y		CT: E	
	MIN.	MAX.	MIN.	MAX.
22	50 Ω	300 kΩ	10 Ω	500 kΩ
55	1 kΩ	1.5 MΩ	150 Ω	2 MΩ
515	1 kΩ	2 MΩ	100 Ω	5 MΩ
0603	39 Ω	210 kΩ	10 Ω	320 kΩ
0805	39 Ω	480 kΩ	10 Ω	720 kΩ
1206	39 Ω	1.8 MΩ	10 Ω	2.7 MΩ
2010	39 Ω	5 MΩ	10 Ω	7.5 MΩ

<b>BEST TOLERANCE AND TCR VS. OHMIC VALUE - Bare Resistors Networks</b>				
SERIES	OHMIC RANGE			
	CT: Y		CT: E	
	MIN.	MAX.	MIN.	MAX.
33	1 kΩ	250 kΩ	100 Ω	500 kΩ
48	1 kΩ	200 kΩ	100 Ω	800 kΩ
408	1 kΩ	200 kΩ	100 Ω	400 kΩ
508	1 kΩ	200 kΩ	500 Ω	400 kΩ
816	1 kΩ	200 kΩ	100 Ω	400 kΩ
914	1 kΩ	100 kΩ	500 Ω	200 kΩ

**Note**

- <sup>(1)</sup> Best possible tolerance:  
 0.5 %: 10 Ω to < 20 Ω  
 0.1 %: 20 Ω to < 39 Ω  
 0.05 %: 39 Ω to max. ohmic value

SIZE	LIMITING VOLTAGE in V
22	100 V
55	100 V
515	100 V
0603	75 V
0805	150 V
1206	200 V
2010	300 V

**POPULAR OPTION**

Back side metallized

Option to order: 06 (not available for sizes 22, 33, 55, 515)  
 Please refer to Application Note 53047 "Power Considerations in High Precision Vishay Sfernice Thin Film Chip Resistors and Arrays (High Temperature Applications) [www.vishay.com/doc?53047](http://www.vishay.com/doc?53047) to evaluate performances improvement depending on process (brazing or gluing). Choice of PCB will be determinant.

**GLOBAL PART NUMBERING INFORMATION - Bare Resistors Chips**

Bare Chip Resistors

R	M	K	H	T	0	6	0	3	Y	1	0	0	1	B	A	0	6
---	---	---	---	---	---	---	---	---	---	---	---	---	---	---	---	---	---

GLOBAL MODEL	SIZE	TCR	VALUE	TOLERANCE	PADS	OPTION
RMKHT	22 55 515 0603 0805 1206 2010	Y E	The first 3 digits are significant figures and the last digit specifies the number of zeros to follow. R designates decimal point  10R0 = 10 Ω 3901 = 3900 Ω 1004 = 1 MΩ AA <sup>(2)</sup>	W = 0.05 % B = 0.1 % D = 0.5 % F = 1 %	A: aluminum	Blank = no option 06 = back side metallized

**GLOBAL PART NUMBERING INFORMATION - Bare Resistors Networks**

Bare Resistors Networks

R	M	K	H	T	8	1	6	E	1	0	0	1	B	W	A	0	6
---	---	---	---	---	---	---	---	---	---	---	---	---	---	---	---	---	---

GLOBAL MODEL	SIZE	TCR	VALUE	ABS. TOLERANCE	TOLERANCE RATIO	PADS	OPTION
RMKHT	33 48 408 508 816 914	Y E	The first 3 digits are significant figures and the last digit specifies the number of zeros to follow. R designates decimal point  10R0 = 10 Ω 3901 = 3900 Ω 1004 = 1 MΩ AA <sup>(1)</sup>	W = 0.05 % B = 0.1 % D = 0.5 % F = 1 %	P = 0.02 % W = 0.05 % D = 0.5 % B = 0.1 %	A: aluminum	Blank = no option 06 = back side metallized

**Note**

<sup>(1)</sup> For more than three significant digits an alphabetical code will be used (AA to ZZ) and a cross table will be provided

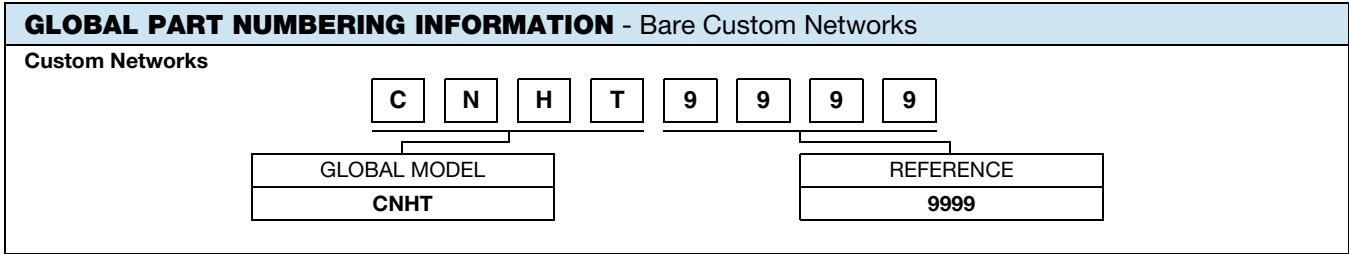

**Note**

- A specific reference number is assigned by Vishay Sfernice



## Disclaimer

ALL PRODUCT, PRODUCT SPECIFICATIONS AND DATA ARE SUBJECT TO CHANGE WITHOUT NOTICE TO IMPROVE RELIABILITY, FUNCTION OR DESIGN OR OTHERWISE.

Vishay Intertechnology, Inc., its affiliates, agents, and employees, and all persons acting on its or their behalf (collectively, "Vishay"), disclaim any and all liability for any errors, inaccuracies or incompleteness contained in any datasheet or in any other disclosure relating to any product.

Vishay makes no warranty, representation or guarantee regarding the suitability of the products for any particular purpose or the continuing production of any product. To the maximum extent permitted by applicable law, Vishay disclaims (i) any and all liability arising out of the application or use of any product, (ii) any and all liability, including without limitation special, consequential or incidental damages, and (iii) any and all implied warranties, including warranties of fitness for particular purpose, non-infringement and merchantability.

Statements regarding the suitability of products for certain types of applications are based on Vishay's knowledge of typical requirements that are often placed on Vishay products in generic applications. Such statements are not binding statements about the suitability of products for a particular application. It is the customer's responsibility to validate that a particular product with the properties described in the product specification is suitable for use in a particular application. Parameters provided in datasheets and / or specifications may vary in different applications and performance may vary over time. All operating parameters, including typical parameters, must be validated for each customer application by the customer's technical experts. Product specifications do not expand or otherwise modify Vishay's terms and conditions of purchase, including but not limited to the warranty expressed therein.

Hyperlinks included in this datasheet may direct users to third-party websites. These links are provided as a convenience and for informational purposes only. Inclusion of these hyperlinks does not constitute an endorsement or an approval by Vishay of any of the products, services or opinions of the corporation, organization or individual associated with the third-party website. Vishay disclaims any and all liability and bears no responsibility for the accuracy, legality or content of the third-party website or for that of subsequent links.

Except as expressly indicated in writing, Vishay products are not designed for use in medical, life-saving, or life-sustaining applications or for any other application in which the failure of the Vishay product could result in personal injury or death. Customers using or selling Vishay products not expressly indicated for use in such applications do so at their own risk. Please contact authorized Vishay personnel to obtain written terms and conditions regarding products designed for such applications.

No license, express or implied, by estoppel or otherwise, to any intellectual property rights is granted by this document or by any conduct of Vishay. Product names and markings noted herein may be trademarks of their respective owners.