

N-Channel Enhancement Mode Power MOSFET

Description

The 18N20J uses advanced trench technology to provide excellent $R_{DS(ON)}$, low gate charge. It can be used in a wide variety of applications.

General Features

- V_{DS} 200V
- I_D (at $V_{GS} = 10V$) 18A
- $R_{DS(ON)}$ (at $V_{GS} = 10V$) < 190mΩ
- 100% Avalanche Tested
- RoHS Compliant

Application

- Power switch
- DC/DC converters

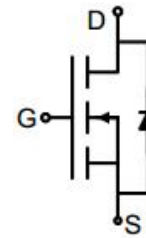

Schematic diagram

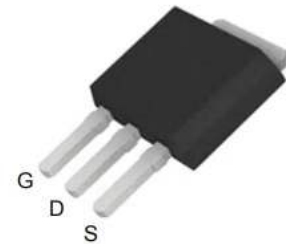

TO-251

Ordering Information

Device	Package	Marking	Packaging
18N20J	TO-251	18N20	75pcs/Tube

Absolute Maximum Ratings $T_C = 25^\circ C$, unless otherwise noted

Parameter	Symbol	Value	Unit
Drain-Source Voltage	V_{DS}	200	V
Continuous Drain Current	I_D	18	A
Pulsed Drain Current (note1)	I_{DM}	72	A
Gate-Source Voltage	V_{GS}	± 20	V
Power Dissipation	P_D	65.8	W
Single pulse avalanche energy (note2)	E_{AS}	90	mJ
Operating Junction and Storage Temperature Range	T_J, T_{stg}	-55 To 150	$^\circ C$

Thermal Resistance

Parameter	Symbol	Value	Unit
Thermal Resistance, Junction-to-Ambient	R_{thJA}	50	$^\circ C/W$
Maximum Junction-to-Case	R_{thJC}	1.9	$^\circ C/W$

Specifications $T_J = 25^\circ\text{C}$, unless otherwise noted						
Parameter	Symbol	Test Conditions	Value			Unit
			Min.	Typ.	Max.	
Static Parameters						
Drain-Source Breakdown Voltage	$V_{(BR)DSS}$	$V_{GS} = 0V, I_D = 250\mu A$	200	--	--	V
Zero Gate Voltage Drain Current	I_{DSS}	$V_{DS} = 200V, V_{GS} = 0V$	--	--	1	μA
Gate-Source Leakage	I_{GSS}	$V_{GS} = \pm 20V$	--	--	± 100	nA
Gate-Source Threshold Voltage	$V_{GS(th)}$	$V_{DS} = V_{GS}, I_D = 250\mu A$	1.0	1.45	3.0	V
Drain-Source On-Resistance	$R_{DS(on)}$	$V_{GS} = 10V, I_D = 9A$	--	131	190	m Ω
Forward Transconductance	g_{FS}	$V_{GS} = 5V, I_D = 9A$	--	8	--	S
Dynamic Parameters						
Input Capacitance	C_{iss}	$V_{GS} = 0V,$ $V_{DS} = 100V,$ $f = 1.0\text{MHz}$	--	850	--	pF
Output Capacitance	C_{oss}		--	71	--	
Reverse Transfer Capacitance	C_{rss}		--	15	--	
Total Gate Charge	Q_g	$V_{DD} = 100V,$ $I_D = 9A,$ $V_{GS} = 10V$	--	18	--	nC
Gate-Source Charge	Q_{gs}		--	4	--	
Gate-Drain Charge	Q_{gd}		--	5.3	--	
Turn-on Delay Time	$t_{d(on)}$	$V_{DD} = 100V,$ $I_D = 9A,$ $R_G = 5\Omega$	--	42	--	ns
Turn-on Rise Time	t_r		--	20.5	--	
Turn-off Delay Time	$t_{d(off)}$		--	125	--	
Turn-off Fall Time	t_f		--	6.5	--	
Drain-Source Body Diode Characteristics						
Continuous Body Diode Current	I_S	$T_C = 25^\circ\text{C}$	--	--	18	A
Body Diode Voltage	V_{SD}	$T_J = 25^\circ\text{C}, I_{SD} = 9A, V_{GS} = 0V$	--	--	1.2	V
Reverse Recovery Charge	Q_{rr}	$I_F = 9A, V_{GS} = 0V$ $di/dt = 100A/\mu s$	--	1066	--	nC
Reverse Recovery Time	T_{rr}		--	239	--	ns

Notes

1. Repetitive Rating: Pulse width limited by maximum junction temperature
2. EAS condition : $T_J = 25^\circ\text{C}, V_{DD} = 50V, V_{GS} = 10V, L = 0.5\text{mH}, R_G = 25\Omega$
3. Identical low side and high side switch with identical R_G

Gate Charge Test Circuit



Switch Time Test Circuit



EAS Test Circuit



Typical Characteristics $T_J = 25^\circ\text{C}$, unless otherwise noted

Figure 1. Output Characteristics

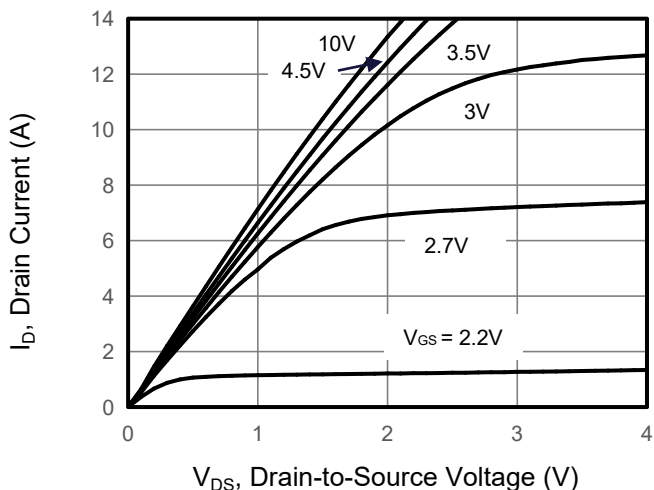

Figure 2. Transfer Characteristics

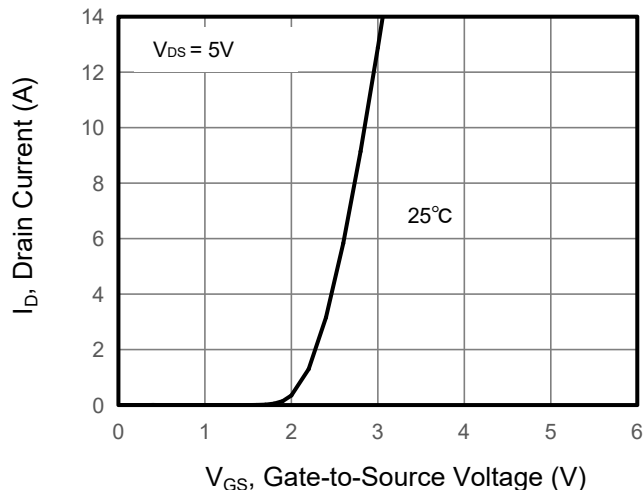

Figure 3. Drain Source On Resistance

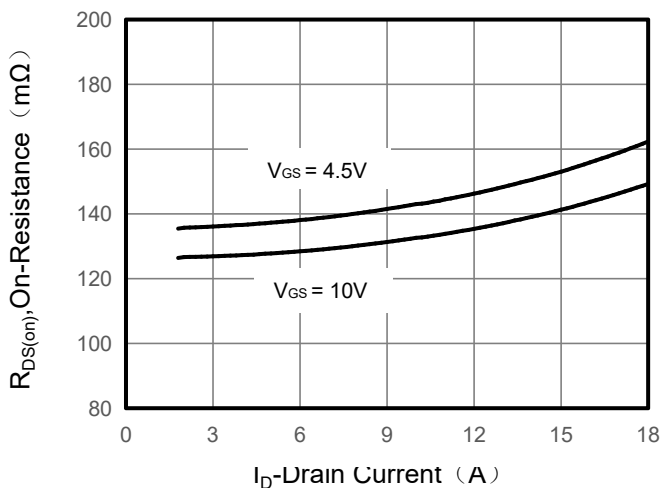

Figure 4. Gate Charge

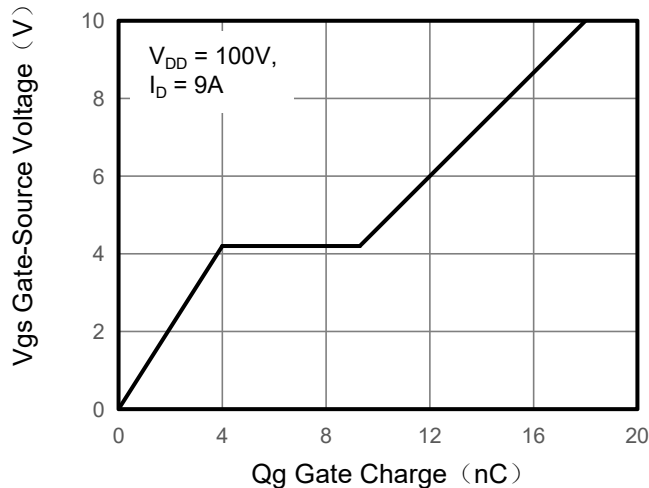

Figure 5. Capacitance

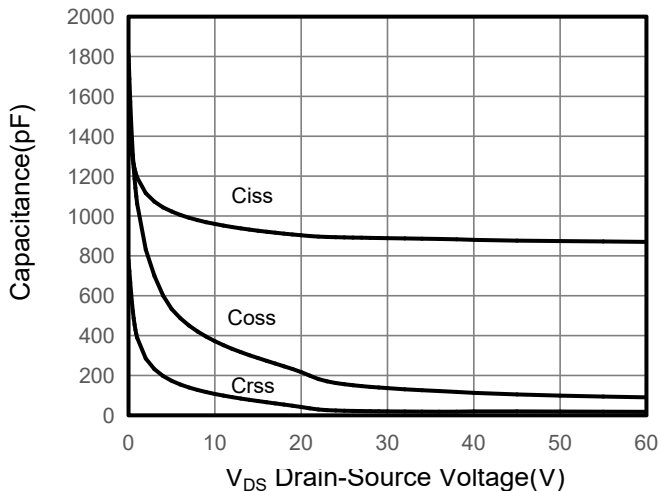
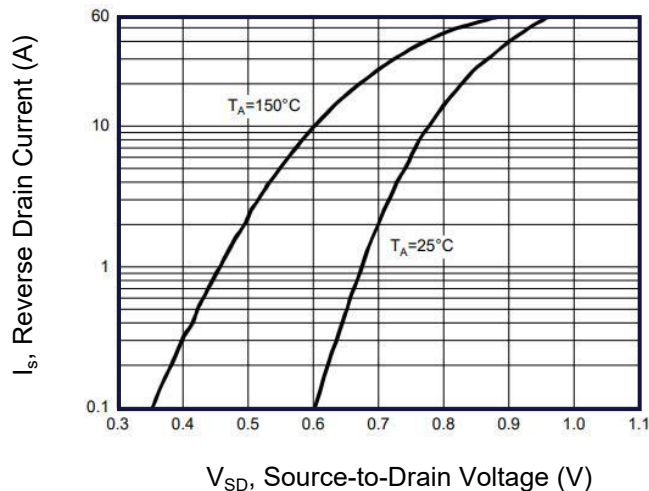

Figure 6. Source-Drain Diode Forward



Typical Characteristics $T_J = 25^\circ\text{C}$, unless otherwise noted

Figure 7. Drain-Source On-Resistance

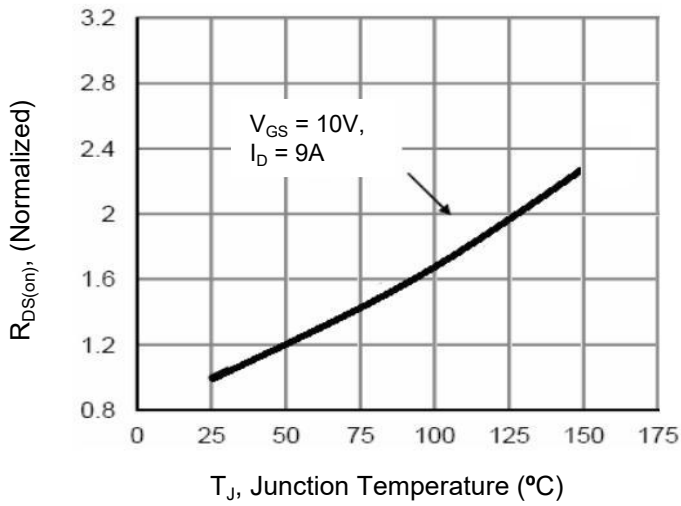

Figure 8. Safe Operation Area

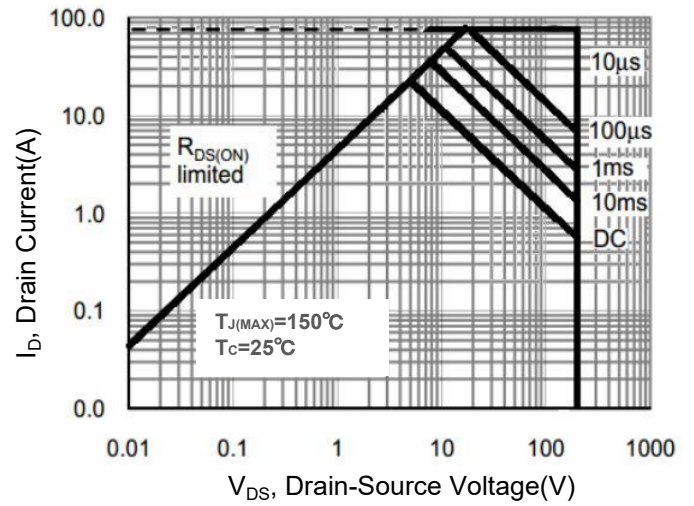
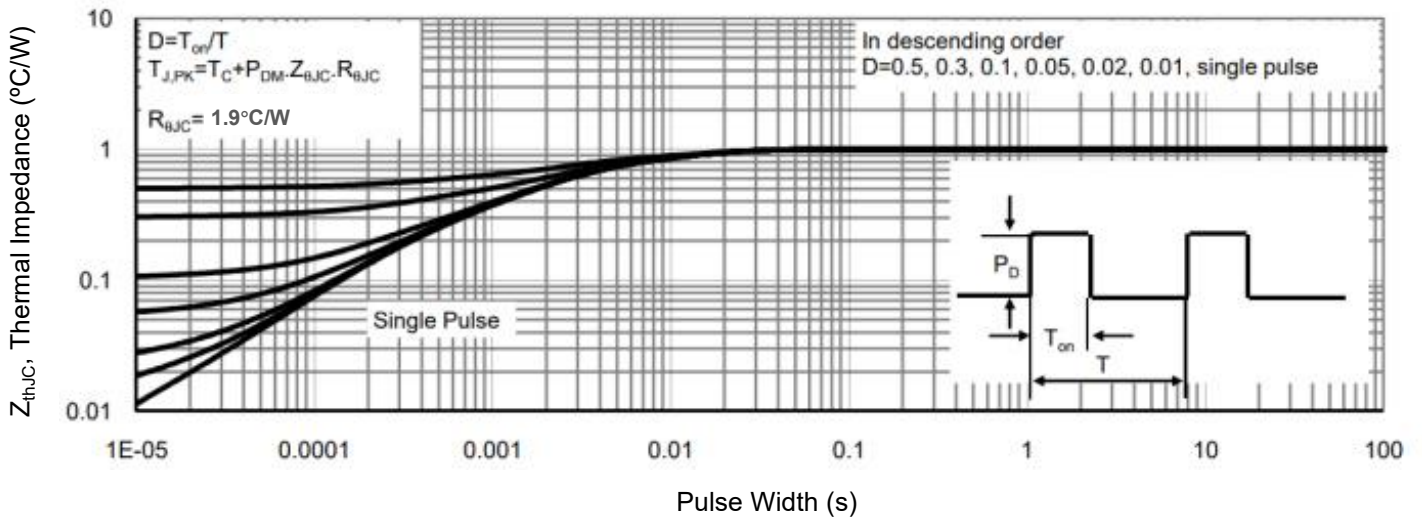
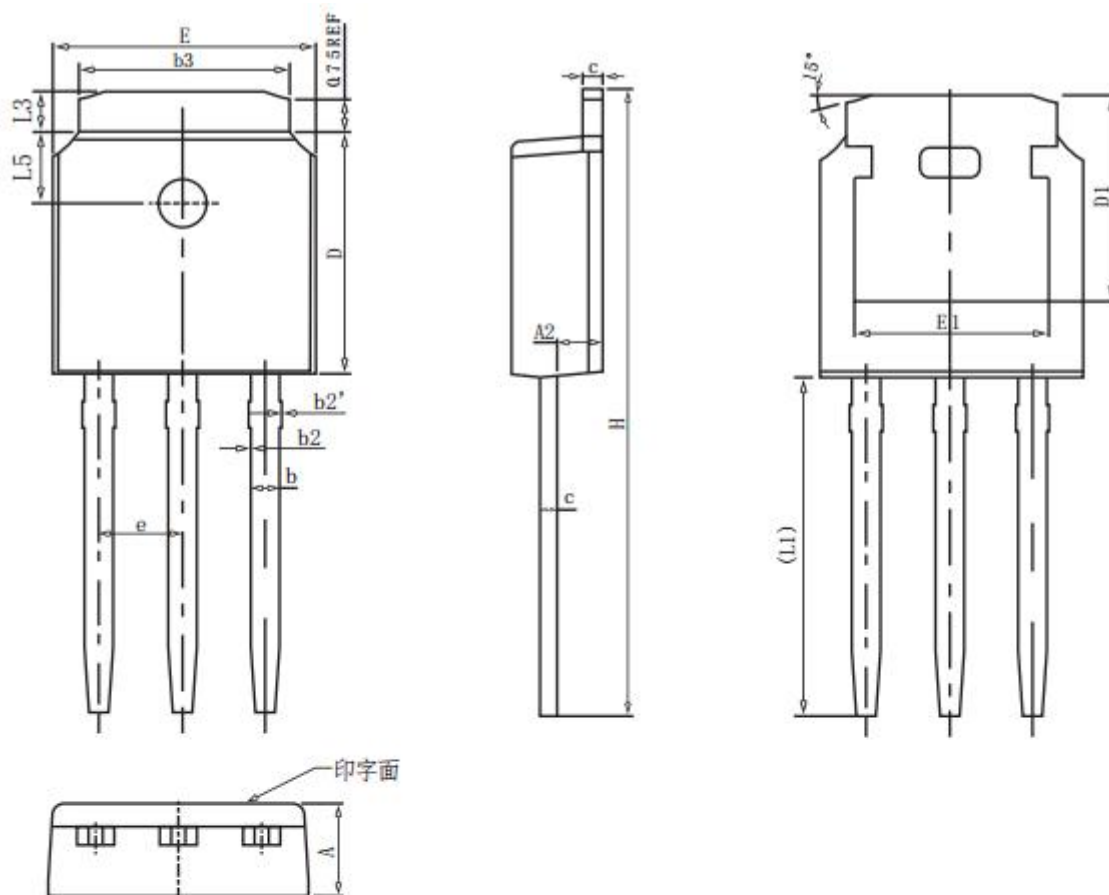

Figure 9. Normalized Maximum Transient Thermal Impedance



TO-251 Package Information



COMMON DIMENSIONS

SYMBOL	mm		
	MIN	NOM	MAX
A	2.20	2.30	2.40
A2	0.97	1.07	1.17
b	0.68	0.78	0.90
b2	0.00	0.04	0.10
b2'	0.00	0.04	0.10
b3	5.20	5.33	5.50
c	0.43	0.53	0.63
D	5.98	6.10	6.22
D1	5.30REF		
E	6.40	6.60	6.80
E1	4.63	-	-
e	2.286BSC		
H	16.22	16.52	16.82
L1	9.15	9.40	9.65
L3	0.88	1.02	1.28
L5	1.65	1.80	1.95