

## Current-Limiting Power Distribution Switches

### Features

- 1.8V to 5.5V Supply Voltage
- 790 m $\Omega$  Typical  $R_{DS(ON)}$  at 3.3V
- MIC2090 is Rated for 50 mA Minimum Continuous Current
- MIC2091 is Rated for 100 mA Minimum Continuous Current
- Reverse Current Blocking (OGI)
- 20 ns Super Fast Reaction Time to Hard Short at Output
- 10 ms Fault Flag Delay ( $t_{D\_FAULT}$ ) Eliminates False Assertions
- Auto-Retry Overcurrent and Short-Circuit Protection (-1 Version)
- Latch-Off on Current-Limit (-2 Version)
- Thermal Shutdown
- Fault Status Flag Indicates: Overcurrent, Overtemperature, or UVLO
- Undervoltage Lockout (UVLO)
- Low Quiescent Current

### Applications

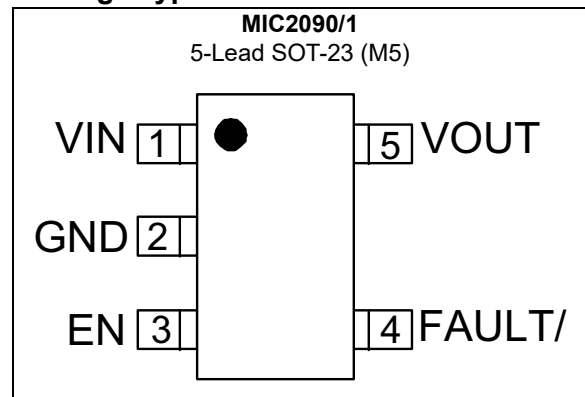
- USB Peripherals
- Camcorder
- DSC
- MP3/iPod
- SD Protection
- USB Low-Power Hub

### General Description

The MIC2090 and MIC2091 are high-side MOSFET power switches optimized for general purpose 50 mA or 100 mA low power distribution in circuits that require overcurrent limiting and circuit protection. Typical applications for these parts include switching power in USB ports, portable consumer items, camera and camcorder motor protection, thermal printer head protection, and many other low current-load switching applications.

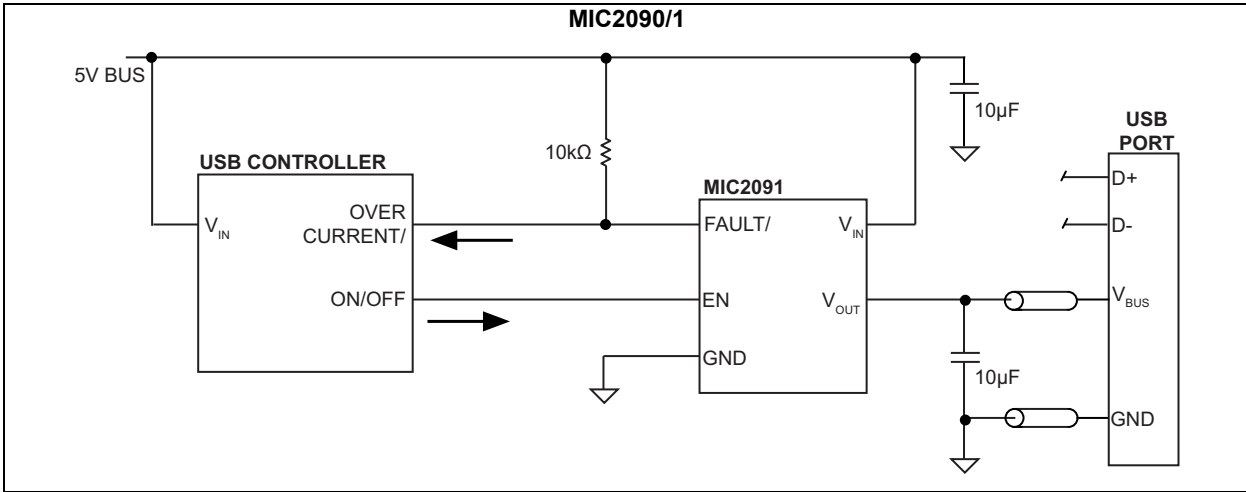
The MIC2090 and MIC2091 come in two versions: auto-retry current-limit and output latch off on an overcurrent fault. The MIC2090 and MIC2091 are offered in a space saving 5-pin SOT-23 package with an operating junction temperature range of  $-40^{\circ}\text{C}$  to  $+125^{\circ}\text{C}$ .

### Package Type

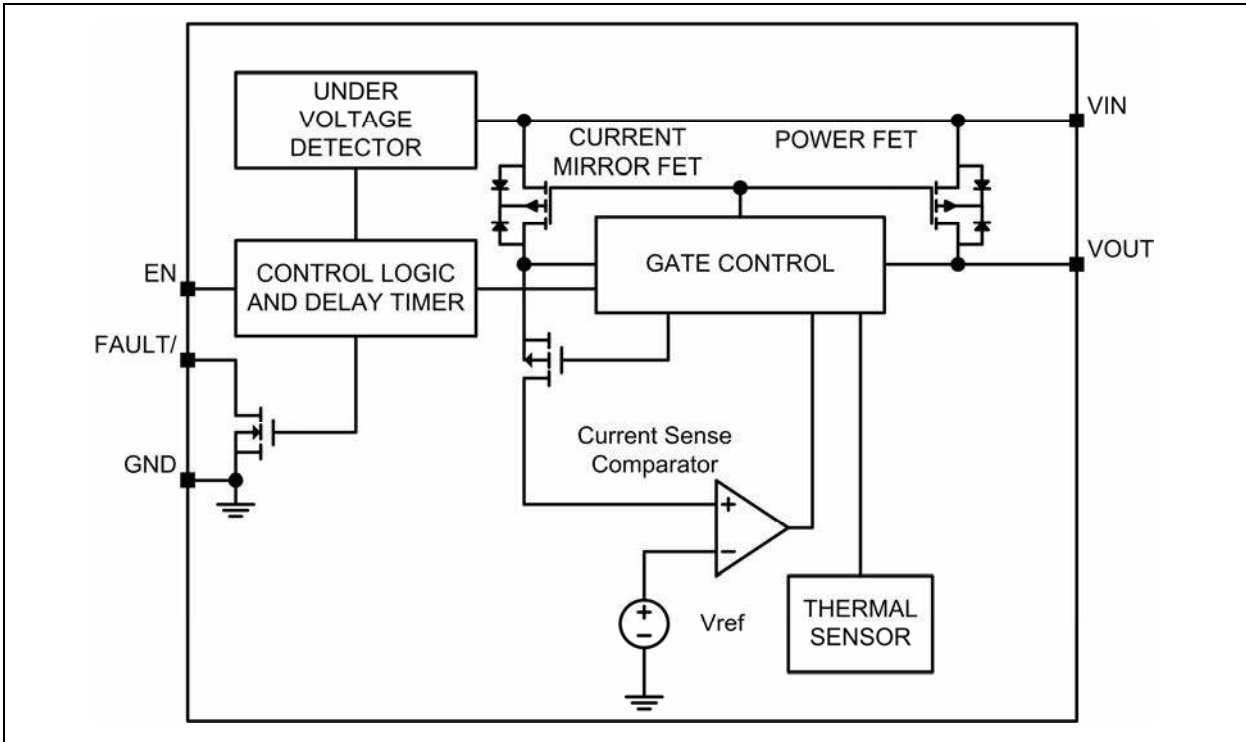


# MIC2090/1

## Typical Application Circuit



## Functional Block Diagram



## 1.0 ELECTRICAL CHARACTERISTICS

### Absolute Maximum Ratings †

Supply Voltage ( $V_{IN}$ )	.....	-0.3V to +6.0V
Output Voltage ( $V_{OUT}$ )	.....	-0.3V to +6.0V
FAULT/ Pin Voltage ( $V_{FAULT/}$ )	.....	-0.3V to +6.0V
FAULT/ Pin Current ( $I_{FAULT/}$ )	.....	25 mA
EN Pin Voltage ( $V_{EN}$ )	.....	-0.3V to ( $V_{IN} + 0.3V$ )
Power Dissipation ( $P_D$ )	.....	Internally Limited
ESD Rating (HBM) (Note 1)	.....	3 kV
ESD Rating (MM) (Note 1)	.....	200V

### Operating Ratings ‡

Supply Voltage ( $V_{IN}$ )	.....	+1.8V to +5.5V
Output Voltage ( $V_{OUT}$ )	.....	+1.8V to +5.5V
EN Pin Voltage ( $V_{EN}$ )	.....	0V to $V_{IN}$
FAULT/ Pin Voltage	.....	0V to +5.5V
FAULT/ Pin Current	.....	1 mA

† **Notice:** Stresses above those listed under “Absolute Maximum Ratings” may cause permanent damage to the device. This is a stress rating only and functional operation of the device at those or any other conditions above those indicated in the operational sections of this specification is not intended. Exposure to maximum rating conditions for extended periods may affect device reliability.

‡ **Notice:** The device is not guaranteed to function outside its operating ratings.

**Note 1:** Devices are ESD sensitive. Handling precautions recommended. Human body model, 1.5 k $\Omega$  in series with 100 pF.

## ELECTRICAL CHARACTERISTICS

**Electrical Characteristics:**  $V_{IN} = 5V$ ;  $T_A = +25^\circ C$ , **bold** values indicate  $-40^\circ C \leq T_A \leq +85^\circ C$ , unless noted. [Note 1](#)

Parameter	Symbol	Min.	Typ.	Max.	Units	Conditions
<b>Power Input Supply</b>						
Input Voltage Range	$V_{IN}$	<b>1.8</b>	—	<b>5.5</b>	V	—
Shutdown Current	$I_{VIN}$	—	5	<b>10</b>	$\mu A$	$V_{EN} \leq 0.5V$ (switch off), $V_{OUT} = \text{open}$
Supply Current		—	70	<b>110</b>		$V_{EN} \geq 1.5V$ (switch on), $V_{OUT} = \text{open}$
Undervoltage Lockout Threshold	$V_{UVLO}$	—	—	<b>1.75</b>	V	$V_{IN}$ rising
Undervoltage Lockout Threshold Hysteresis	$V_{UVLO\_HYS}$	—	100	—	mV	—
<b>Enable Input</b>						
Enable Logic Level High	$V_{EN}$	1.5	—	—	V	$V_{IH(MIN)}$ , <a href="#">Note 2</a>
Enable Logic Level Low		—	—	<b>0.5</b>		$V_{IL(MAX)}$ , <a href="#">Note 2</a>
Enable Current Bias	$I_{EN}$	—	0.1	—	$\mu A$	$V_{EN} = 5V$
Output Turn-On Delay	$t_{ON}$	—	215	—	$\mu s$	$R_L = 500\Omega$ , $C_L = 0.1 \mu F$ See <a href="#">Timing Diagrams</a> .
Output Turn-On Rise Time	$t_R$	—	5	—	$\mu s$	$R_L = 500\Omega$ , $C_L = 0.1 \mu F$ See <a href="#">Timing Diagrams</a> .
Output Turn-Off Delay	$t_{OFF}$	—	125	—	$\mu s$	$R_L = 500\Omega$ , $C_L = 0.1 \mu F$ See <a href="#">Timing Diagrams</a> .

# MIC2090/1

## ELECTRICAL CHARACTERISTICS (CONTINUED)

Electrical Characteristics:  $V_{IN} = 5V$ ;  $T_A = +25^\circ C$ , **bold** values indicate  $-40^\circ C \leq T_A \leq +85^\circ C$ , unless noted. [Note 1](#)

Parameter	Symbol	Min.	Typ.	Max.	Units	Conditions
Output Turn-Off Fall Time	$t_F$	—	115	—	$\mu s$	$R_L = 500\Omega$ , $C_L = 0.1 \mu F$ See <a href="#">Timing Diagrams</a> .
<b>Internal Switch</b>						
On-Resistance	$R_{DS(ON)}$	—	700	<b>1200</b>	m $\Omega$	MIC2090 $V_{IN} = 5.0V$ , $I_{OUT} = 50 \text{ mA}$
		—	790	<b>1200</b>		MIC2090 $V_{IN} = 3.3V$ , $I_{OUT} = 50 \text{ mA}$
		—	1300	—		MIC2090 $V_{IN} = 1.8V$ , $I_{OUT} = 50 \text{ mA}$
		—	700	<b>1200</b>		MIC2091 $V_{IN} = 5.0V$ , $I_{OUT} = 100 \text{ mA}$
		—	790	<b>1200</b>		MIC2091 $V_{IN} = 3.3V$ , $I_{OUT} = 100 \text{ mA}$
		—	1300	—		MIC2091 $V_{IN} = 1.8V$ , $I_{OUT} = 100 \text{ mA}$
Input-to-Output Leakage Current (Forward Leakage Current)	—	—	—	<b>10</b>	$\mu A$	MIC2090 and MIC2091, $V_{EN} \leq 0.5V$ , (output off), $V_{IN} = 5.5V$ , $V_{OUT} = 0V$
Output-to-Input Leakage Current (Reverse Leakage Current)	—	—	—	<b>10</b>	$\mu A$	MIC2090 and MIC2091, $V_{EN} \leq 0.5V$ , (output off), $V_{OUT} = 5.5V$ , $V_{IN} = 0V$
<b>Current-Limit</b>						
Current-Limit Threshold	$I_{LIMIT}$	<b>50</b>	75	<b>100</b>	mA	MIC2090 @ $V_{OUT} = 4.5V$
		<b>50</b>	100	<b>150</b>		MIC2090 @ $V_{OUT} = 0V$
		<b>100</b>	150	<b>200</b>		MIC2091 @ $V_{OUT} = 4.5V$
		<b>100</b>	175	<b>250</b>		MIC2091 @ $V_{OUT} = 0V$
Short-Circuit Response Time	$t_{SC\_RESP}$	—	20	—	ns	Short-circuit applied to output after switch is turned on, see <a href="#">Timing Diagrams</a> . $V_{IN} = 3.3V$ .
Time After Switch Shuts Down from an Overcurrent Condition Before It Tries to Turn on Again.	$t_{AUTO\_RESTART}$	<b>30</b>	60	<b>90</b>	ms	—
<b>FAULT/ Flag</b>						
Error Flag Output Voltage	—	—	—	<b>0.4</b>	V	Sinking 1 mA
Time After Switch Comes into Current-Limit before the Pin FAULT/ is Pulled Low.	$t_{D\_FAULT/}$	<b>5</b>	10	<b>20</b>	ms	When an overcurrent condition happens, the part will go into constant output current for this time. After this time, it will turn off the output and pull low the pin FAULT/. The MIC2090-1 and MIC2091-1 will automatically restart themselves after the auto restart time $t_{AURESTART}$ .
FAULT/ Rising Time	$t_{R\_FAULT/}$	—	5	—	$\mu s$	FAULT/ is connected to $V_{IN} = 5V$ through 10 k $\Omega$ and 100 pF in parallel. See <a href="#">Timing Diagrams</a> .
FAULT/ Falling Time	$t_{F\_FAULT/}$	—	1	—	$\mu s$	—
<b>Reverse Voltage Protection (OGI)</b>						
Output Voltage Greater than Input Voltage	OGI	—	85	—	mV	If the output voltage is greater than the input voltage by this amount, the part will shut down. The enable pin must be cycled to reset.

## ELECTRICAL CHARACTERISTICS (CONTINUED)

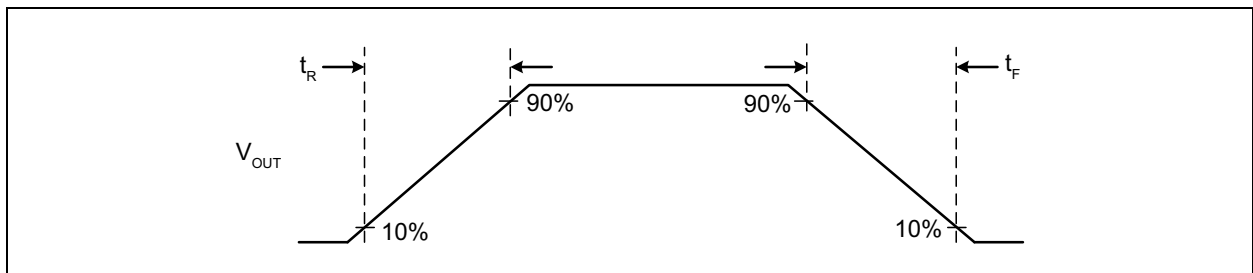
Electrical Characteristics:  $V_{IN} = 5V$ ;  $T_A = +25^\circ C$ , **bold** values indicate  $-40^\circ C \leq T_A \leq +85^\circ C$ , unless noted. [Note 1](#)

Parameter	Symbol	Min.	Typ.	Max.	Units	Conditions
—	$OGI_{TIME}$	—	10	—	ms	Time that the output voltage can be greater than the input voltage before the chip is shut down.
<b>Thermal Protection</b>						
Overtemperature Shutdown	$T_{OVER-TEMP}$	—	150	—	°C	$T_J$ rising
		—	140	—		$T_J$ falling

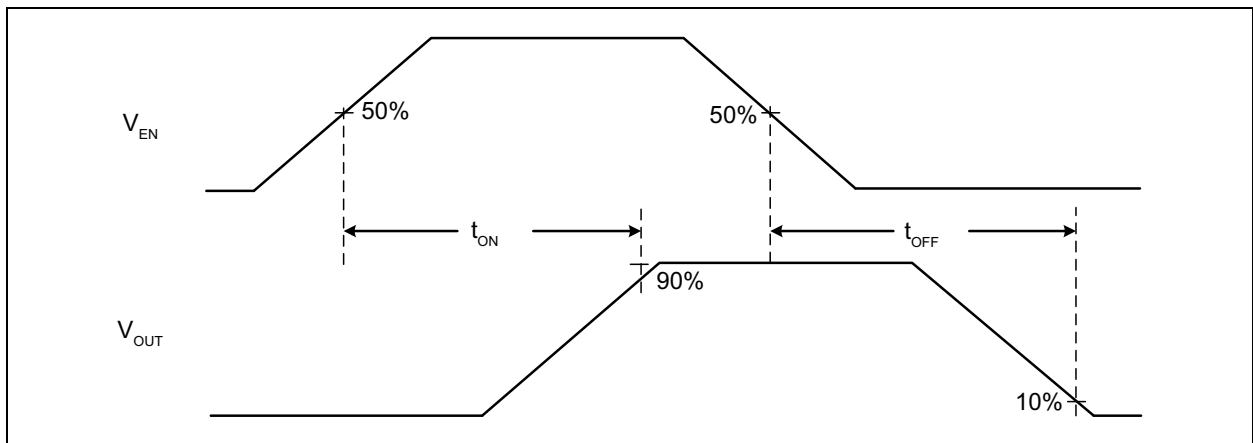
**Note 1:** Specification for packaged product only.

- 2:**  $V_{IL(MAX)}$  = Maximum positive voltage applied to the input that will be accepted by the device as a logic low.  
 $V_{IH(MIN)}$  = Minimum positive voltage applied to the input that will be accepted by the device as a logic high.

## Timing Diagrams



**FIGURE 1-1:** Output Rise and Fall Times ( $t_R$ ,  $t_F$ ).



**FIGURE 1-2:** Switch Delay Time ( $t_{ON}$ ,  $t_{OFF}$ ).

# MIC2090/1

---

---

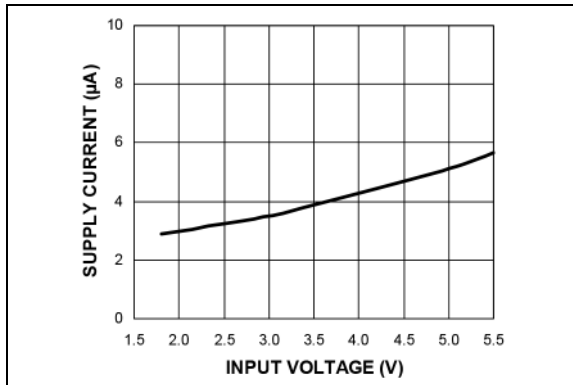
## TEMPERATURE SPECIFICATIONS (Note 1)

Parameters	Sym.	Min.	Typ.	Max.	Units	Conditions
<b>Temperature Ranges</b>						
Storage Temperature Range	$T_J$	-65	—	+150	°C	—
Junction Operating Temperature Range	$T_J$	-40	—	+125	°C	—
Ambient Operating Temperature Range	$T_A$	-40	—	+85	°C	—
Lead Temperature	—	—	—	+260	°C	Soldering, 5s
<b>Package Thermal Resistances</b>						
Thermal Resistance SOT-23	$\theta_{JA}$	—	252.7	—	°C/W	—

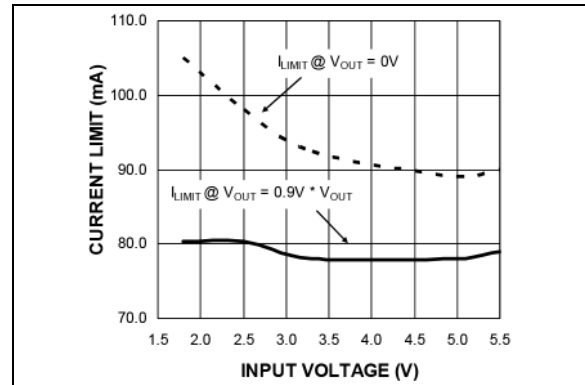
**Note 1:** The maximum allowable power dissipation is a function of ambient temperature, the maximum allowable junction temperature and the thermal resistance from junction to air (i.e.,  $T_A$ ,  $T_J$ ,  $\theta_{JA}$ ). Exceeding the maximum allowable power dissipation will cause the device operating junction temperature to exceed the maximum +125°C rating. Sustained junction temperatures above +125°C can impact the device reliability.

## 2.0 TYPICAL PERFORMANCE CURVES

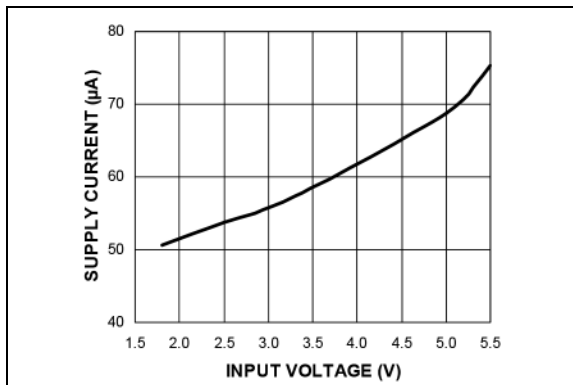
**Note:** The graphs and tables provided following this note are a statistical summary based on a limited number of samples and are provided for informational purposes only. The performance characteristics listed herein are not tested or guaranteed. In some graphs or tables, the data presented may be outside the specified operating range (e.g., outside specified power supply range) and therefore outside the warranted range.



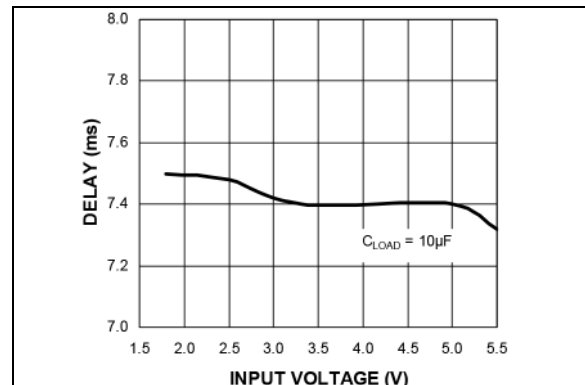
**FIGURE 2-1:**  $V_{IN}$  Shutdown Current vs. Input Voltage.



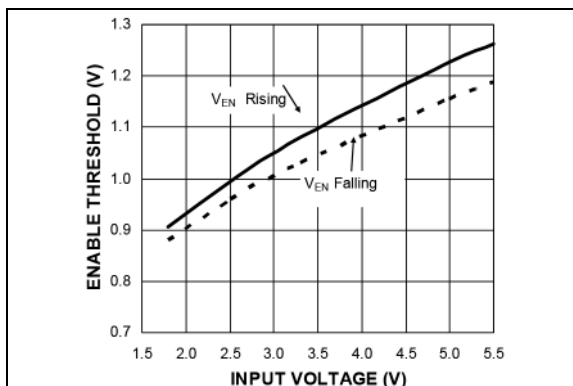
**FIGURE 2-4:** MIC2090 Current-Limit vs. Input Voltage.



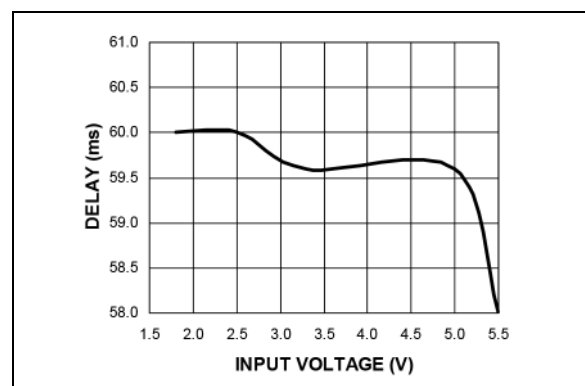
**FIGURE 2-2:**  $V_{IN}$  Supply Current vs. Input Voltage.



**FIGURE 2-5:** MIC2090 FAULT/ Delay vs. Input Voltage.

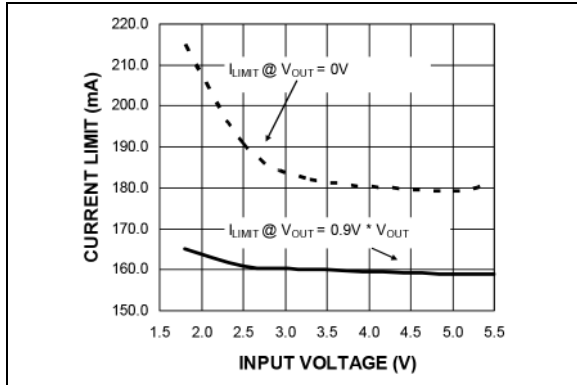


**FIGURE 2-3:** Enable Thresholds vs. Input Voltage.

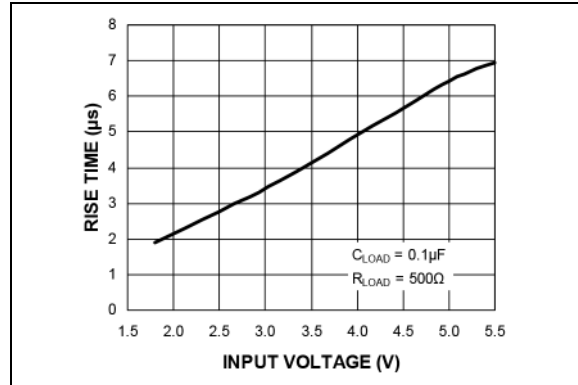


**FIGURE 2-6:** MIC2090 Auto-Reset Time vs. Input Voltage.

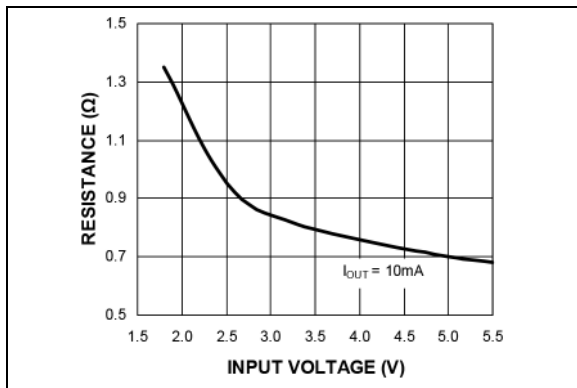
# MIC2090/1



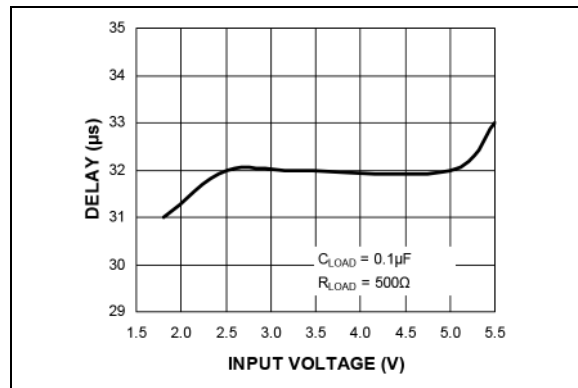
**FIGURE 2-7:** MIC2091 Current-Limit vs. Input Voltage.



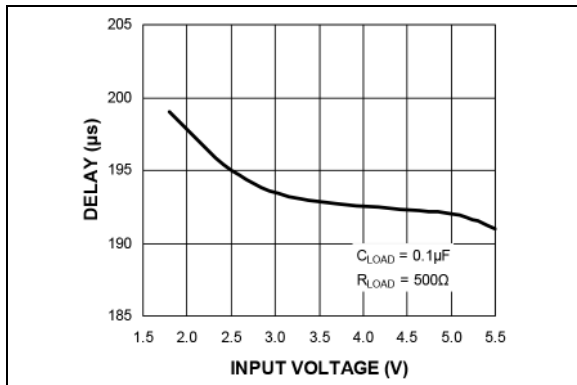
**FIGURE 2-10:** Output Rise Time vs. Input Voltage.



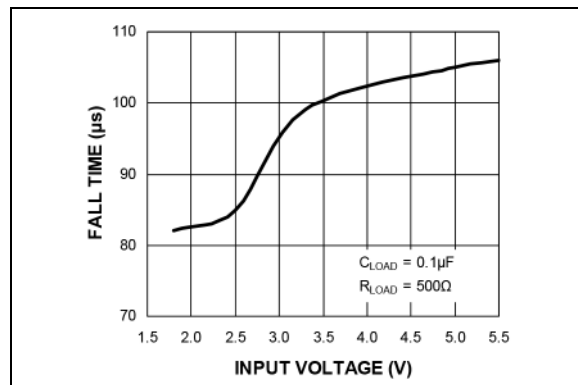
**FIGURE 2-8:** Switch On-Resistance vs. Input Voltage.



**FIGURE 2-11:** Output Turn-Off Delay vs. Input Voltage.

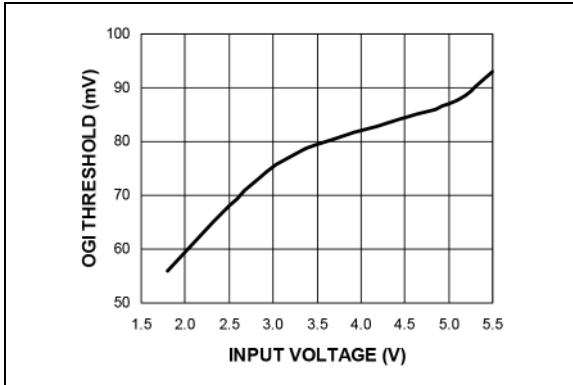


**FIGURE 2-9:** Output Turn-On Delay vs. Input Voltage.

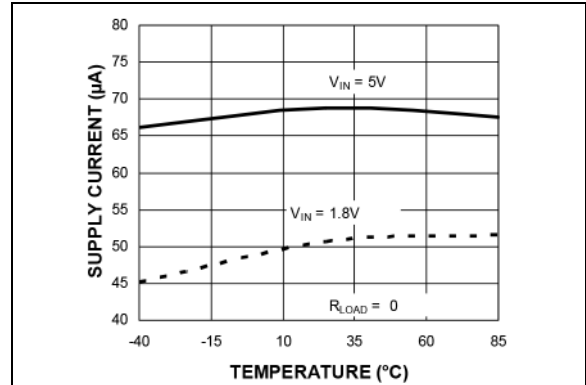


**FIGURE 2-12:** Output Fall Time vs. Input Voltage.

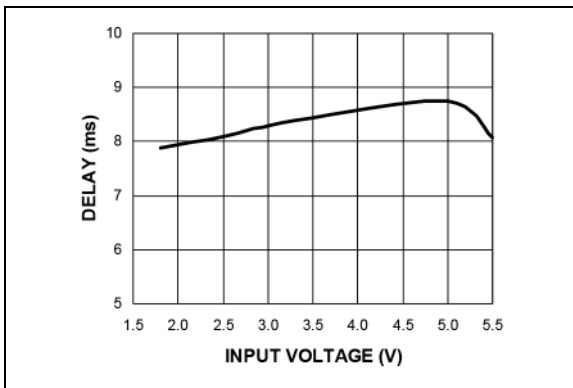




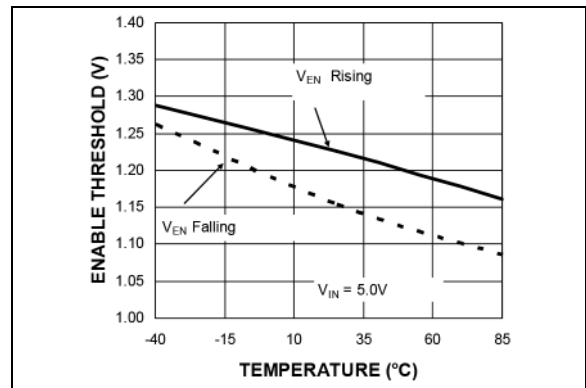
**FIGURE 2-13:** OGI Threshold vs. Input Voltage.



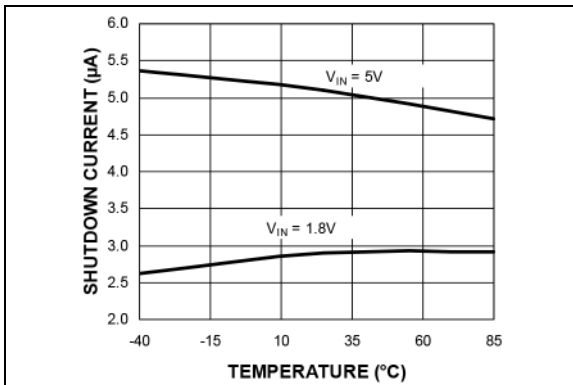
**FIGURE 2-16:**  $V_{IN}$  Supply Current vs. Temperature.



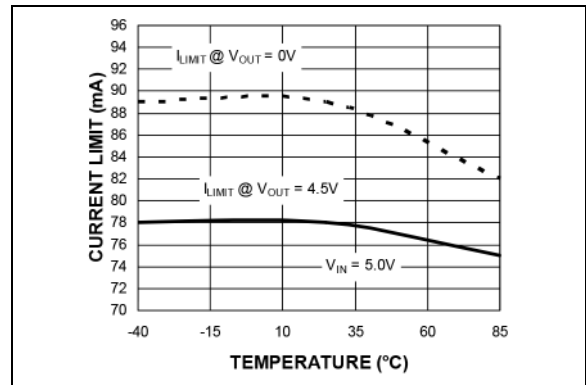
**FIGURE 2-14:** OGI Delay vs. Input Voltage.



**FIGURE 2-17:** Enable Threshold vs. Temperature.

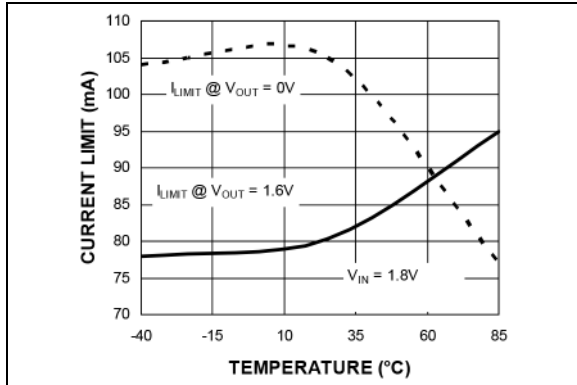


**FIGURE 2-15:**  $V_{IN}$  Shutdown Current vs. Temperature.

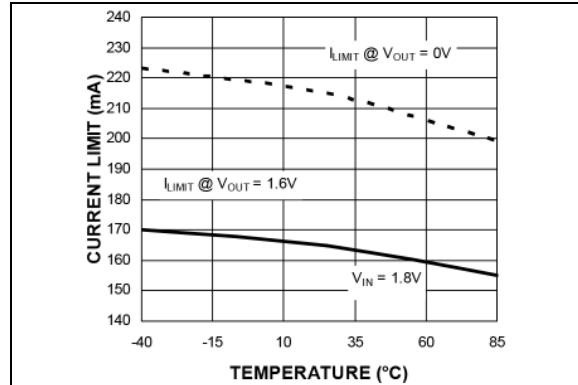


**FIGURE 2-18:** MIC2090 Current-Limit vs. Temperature.

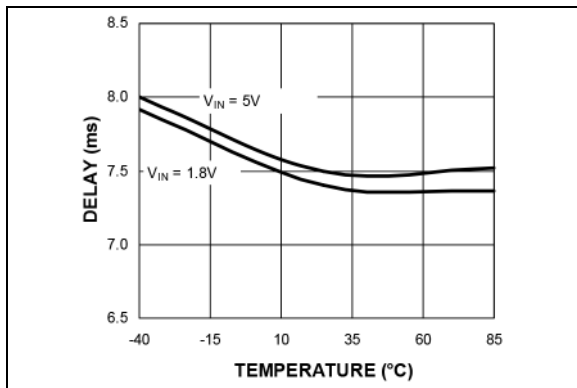
# MIC2090/1



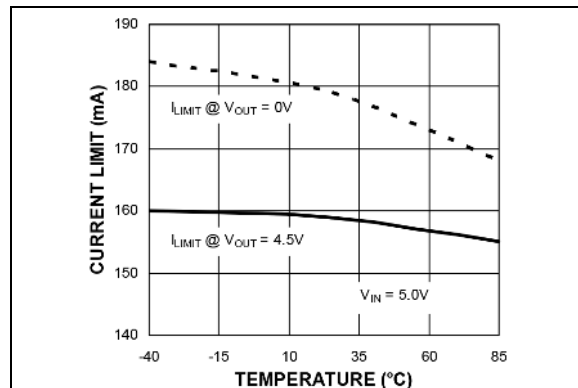
**FIGURE 2-19:** MIC2090 Current-Limit vs. Temperature.



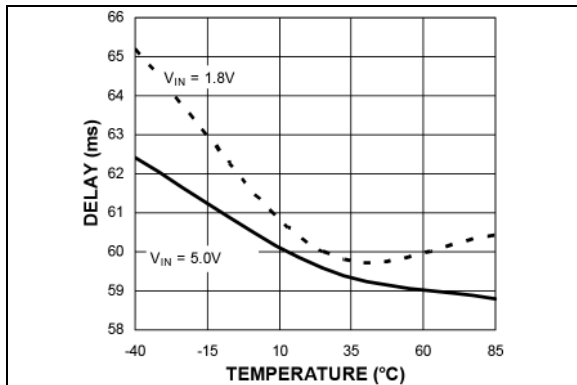
**FIGURE 2-22:** MIC2091 Current-Limit vs. Temperature.



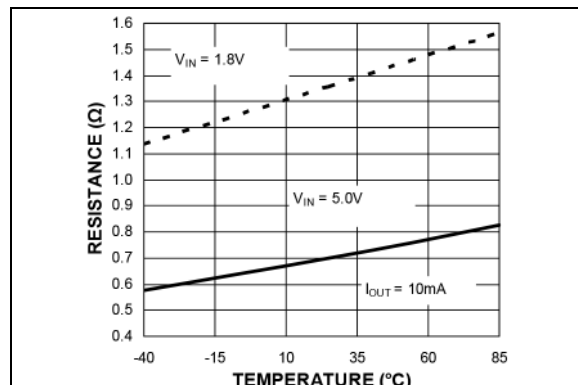
**FIGURE 2-20:** MIC2090 FAULT/ Delay vs. Temperature.



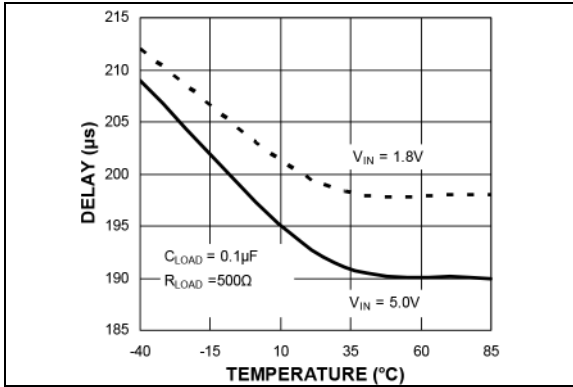
**FIGURE 2-23:** MIC2091 Current-Limit vs. Temperature.



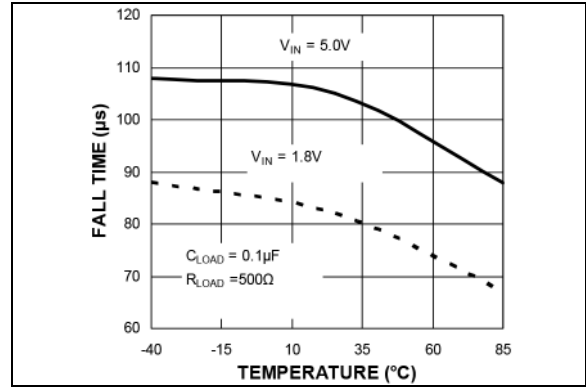
**FIGURE 2-21:** MIC2090 Auto-Reset Time vs. Temperature.



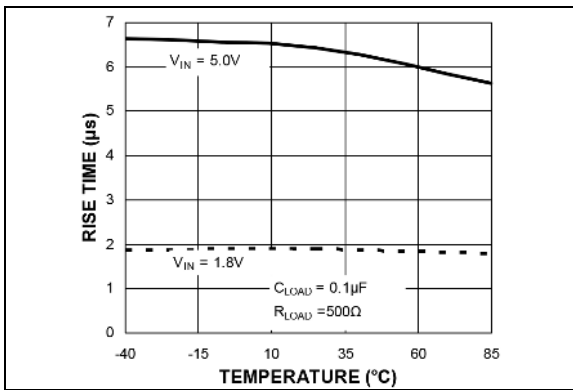
**FIGURE 2-24:**  $R_{DS(ON)}$  vs. Temperature.



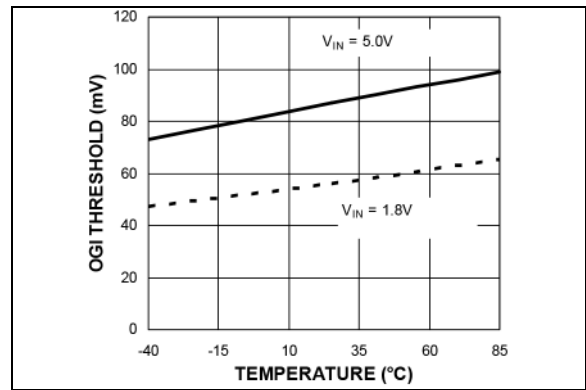
**FIGURE 2-25:** Output Turn-On Delay vs. Temperature.



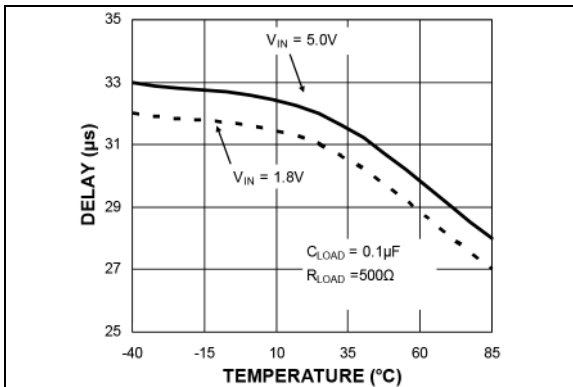
**FIGURE 2-28:** Output Fall Time vs. Temperature.



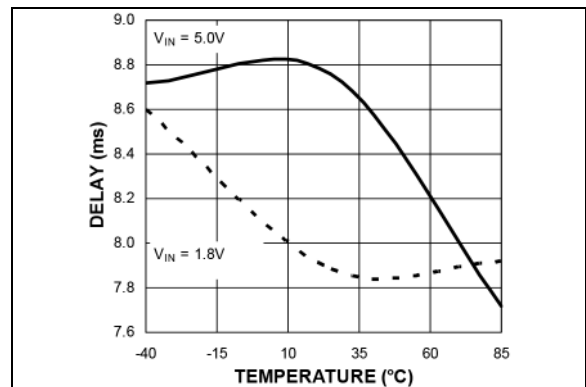
**FIGURE 2-26:** Output Rise Time vs. Temperature.



**FIGURE 2-29:** OGI Threshold vs. Temperature.

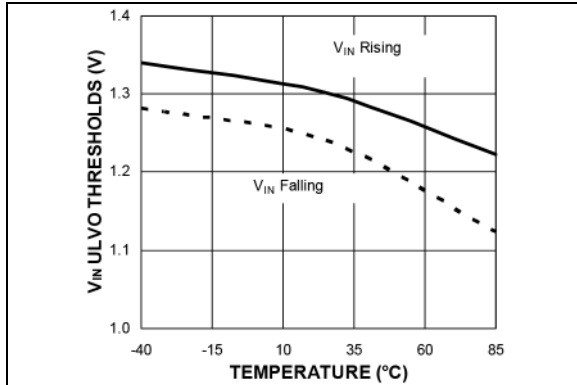


**FIGURE 2-27:** Output Turn-Off Delay vs. Temperature.

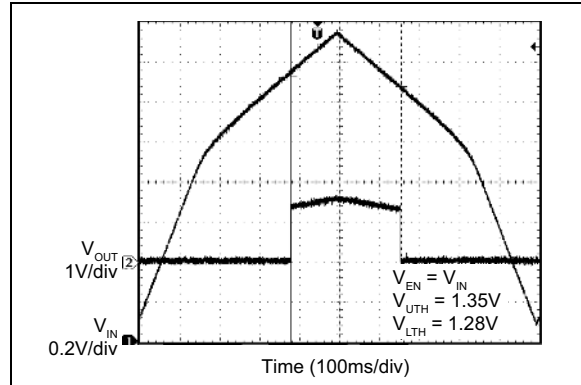


**FIGURE 2-30:** OGI Delay vs. Temperature.

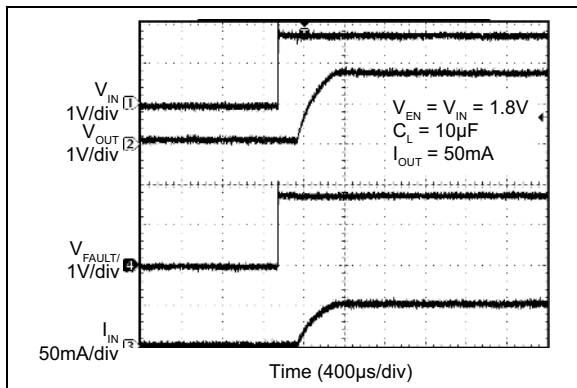
# MIC2090/1



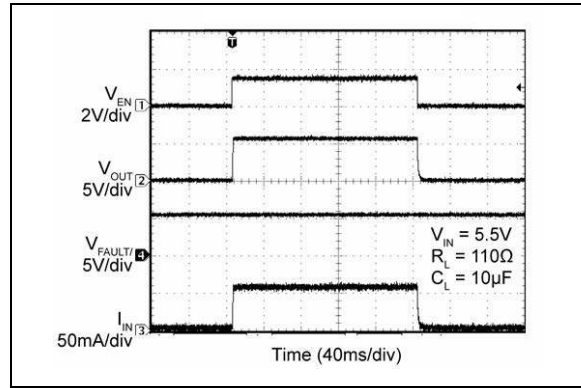
**FIGURE 2-31:**  $V_{IN}$  UVLO Thresholds vs. Temperature.



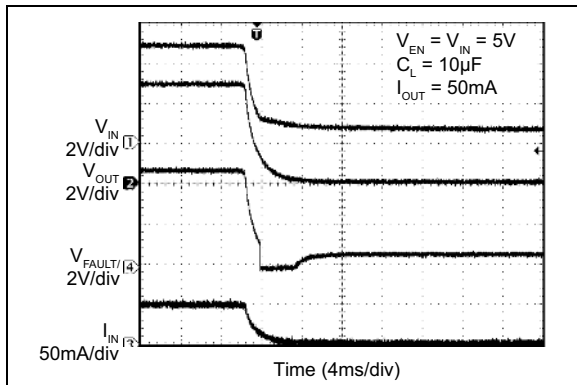
**FIGURE 2-34:** UVLO Thresholds.



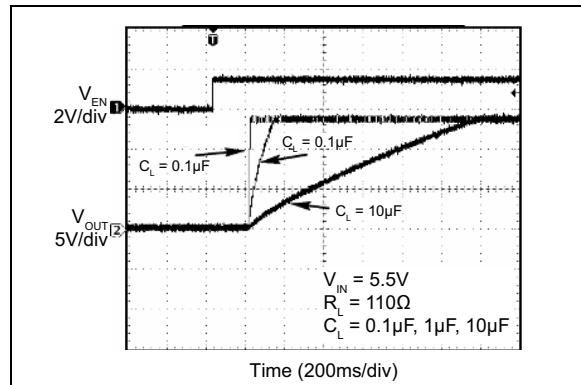
**FIGURE 2-32:**  $V_{IN}$  Turn-On.



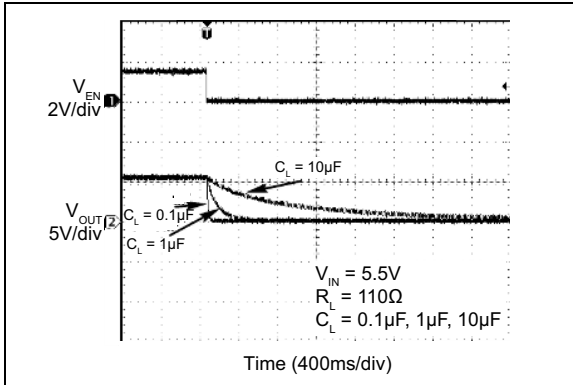
**FIGURE 2-35:** Enable Turn-On/Turn-Off.



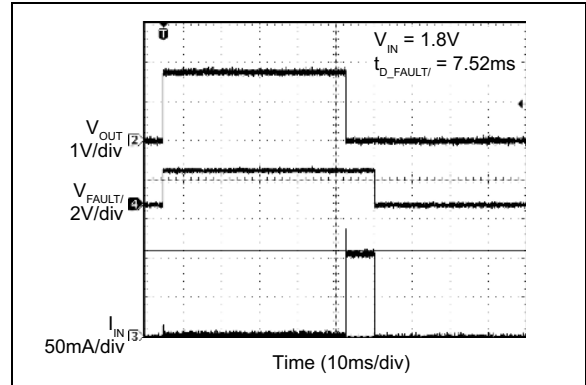
**FIGURE 2-33:**  $V_{IN}$  Turn-Off.



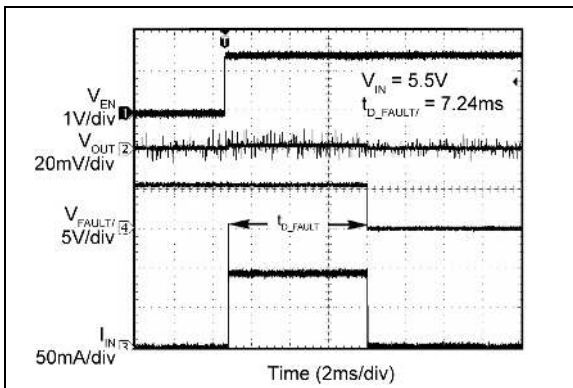
**FIGURE 2-36:** Enable Turn-On Delay and Rise Time.



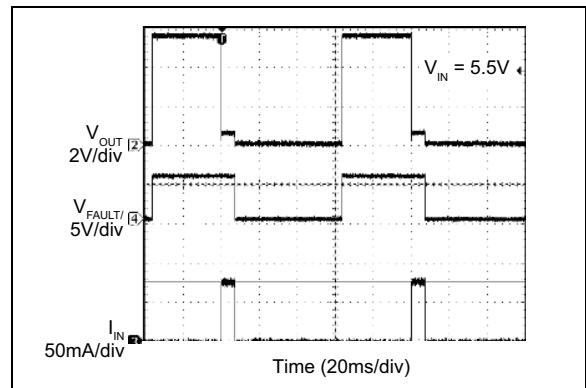
**FIGURE 2-37:** Enable Turn-Off Delay and Fall Time.



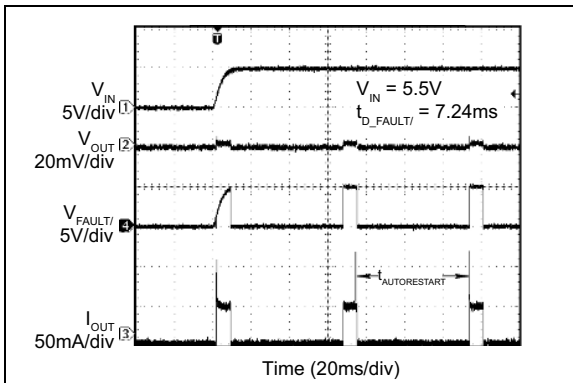
**FIGURE 2-40:** Current-Limit Response, Stepped Short.



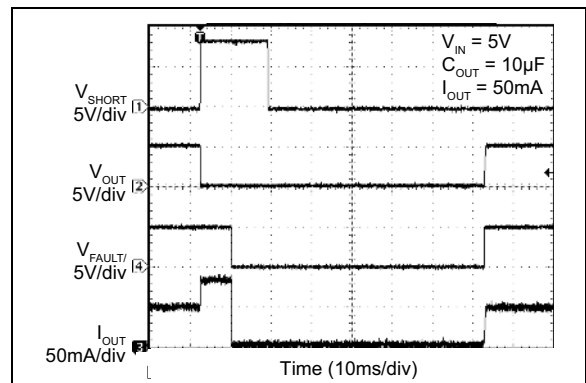
**FIGURE 2-38:** Current-Limit Response, Enabled into Short.



**FIGURE 2-41:** Current-Limit Response, Stepped Overcurrent.

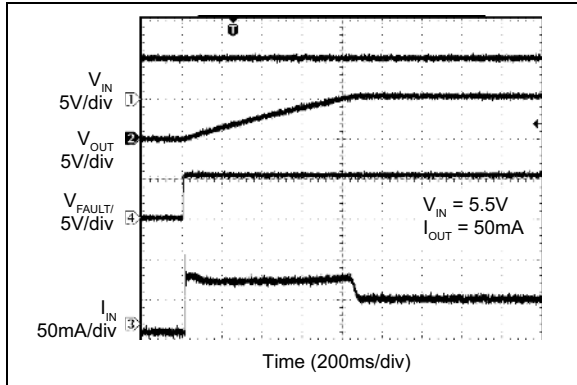


**FIGURE 2-39:** Power-Up into Short-Circuit (-1 Version).

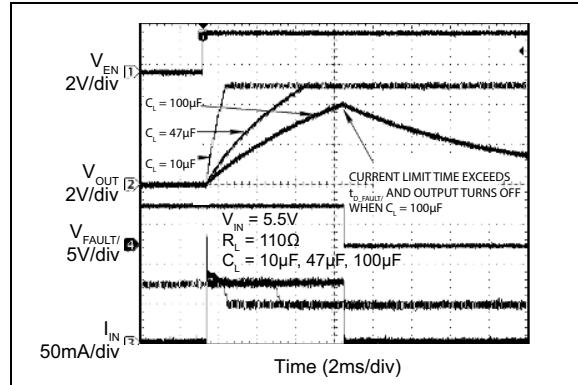


**FIGURE 2-42:** Output Recovery from Short-Circuit and FAULT/ Response (-1 Version).

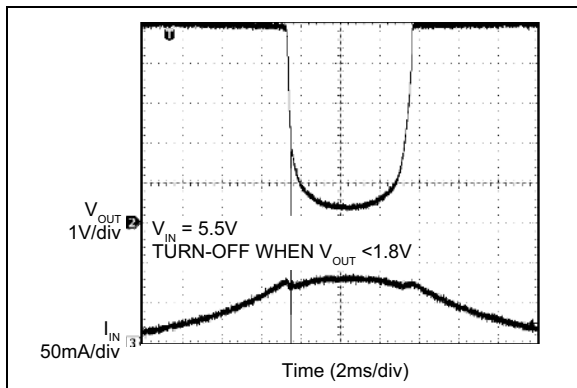
# MIC2090/1



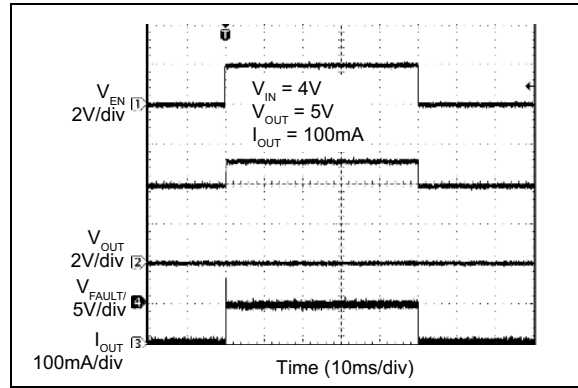
**FIGURE 2-43:** Output Recovery from Thermal Shutdown and FAULT/ Response.



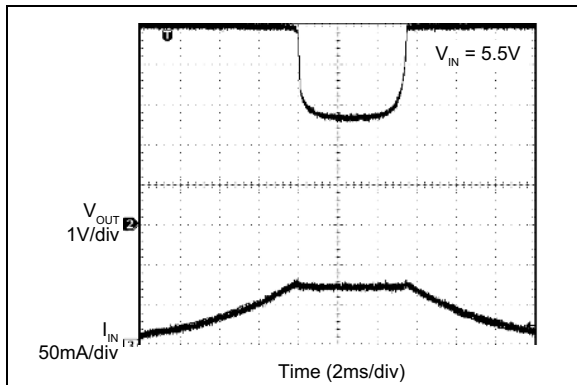
**FIGURE 2-46:** Inrush Current Response.



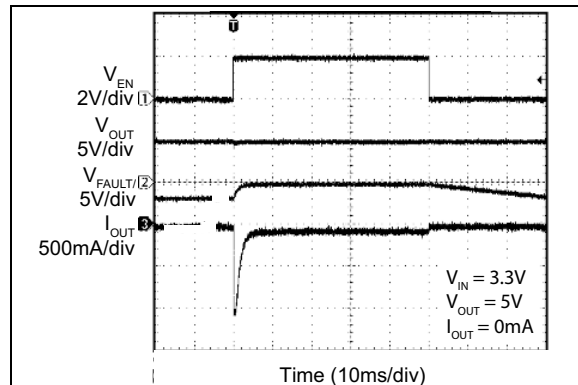
**FIGURE 2-44:**  $I_{OUT}$  Current Limiting for  $V_{OUT} < 1.8V$  (-1 Version).



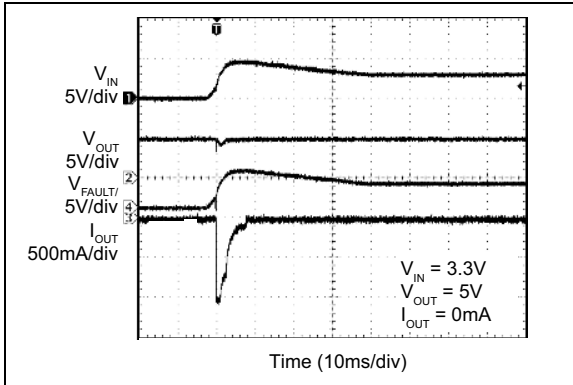
**FIGURE 2-47:**  $V_{OUT} < V_{IN}$ , Enable into Pre-Biased Output.



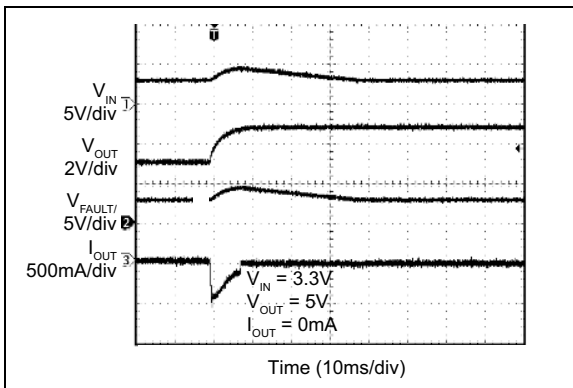
**FIGURE 2-45:**  $I_{OUT}$  Current Limiting for  $V_{OUT} > 1.8V$  (-1 Version).



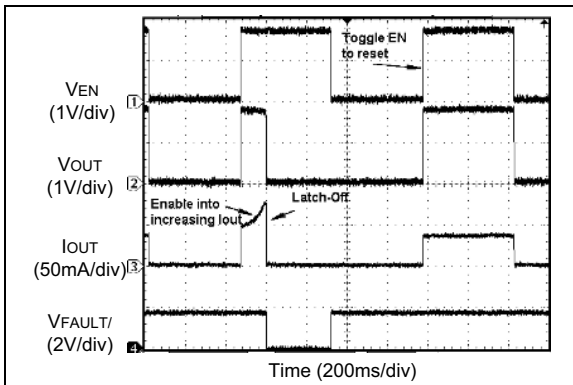
**FIGURE 2-48:**  $V_{OUT} > V_{IN}$ , Enable into Pre-Biased Output.



**FIGURE 2-49:**  $V_{OUT} > V_{IN}$ ,  $V_{IN}$  Turn-On into Pre-Biased Output.



**FIGURE 2-50:** Increase  $V_{OUT}$  Above  $V_{IN}$  While Running.



**FIGURE 2-51:** Overcurrent Latch-Off and Recovery (-2 Version).

# MIC2090/1

---

---

## 3.0 PIN DESCRIPTIONS

The descriptions of the pins are listed in [Table 3-1](#).

**TABLE 3-1: PIN FUNCTION TABLE**

Pin Number	Pin Name	Description
1	VIN	Supply (Input): +1.8V to +5.5V. Provides power to the output switch and the MIC2090/MIC2091 internal control circuitry.
2	GND	Ground.
3	EN	Enable (Input): Active-high TTL compatible control input. A high signal turns on the internal switch and supplies power to the load. This pin cannot be left floating.
4	FAULT/	Fault Status (Output): Open-drain output. Can be connected to other open-drain outputs. Must be pulled high with an external resistor. When EN = 0, FAULT/ pin is high When EN = 1, a low on the FAULT/ pin indicates one or more of the following conditions: 1. The part is in current limit and is turned off. 2. The part is in thermal limit and is turned off. 3. The part is in UVLO
5	VOUT	Switched Output (Output): The voltage on this pin is controlled by the internal switch. Connect the load driven by the MIC2090/MIC2091 to this pin.



## 4.0 FUNCTIONAL DESCRIPTION

### 4.1 $V_{IN}$ and $V_{OUT}$

$V_{IN}$  is both the power supply connection for the internal circuitry driving the switch and the input (source connection) of the power MOSFET switch.  $V_{OUT}$  is the drain connection of the power MOSFET and supplies power to the load. In a typical circuit, current flows from  $V_{IN}$  to  $V_{OUT}$  toward the load.

When the switch is disabled, current will not flow to the load, except for a small unavoidable leakage current of a few microamps (forward leakage current).

### 4.2 $C_{IN}$

A minimum 1  $\mu\text{F}$  bypass capacitor positioned close to the  $V_{IN}$  and GND pins of the switch is both good design practice and required for proper operation of the switch. This will control supply transients and ringing. Without a sufficient bypass capacitor, large current surges or a short may cause sufficient ringing on  $V_{IN}$  (from supply lead inductance) to cause erratic operation of the switch's control circuitry. For best performance, place a ceramic capacitor next to the IC.

An additional 10  $\mu\text{F}$  (or greater) capacitor, positioned close to the  $V_{IN}$  and GND pins of the switch is necessary if the distance between a larger bulk capacitor and the switch is greater than three inches. This additional capacitor limits input voltage transients at the switch caused by fast changing input currents that occur during a fault condition, such as current limit and thermal shutdown.

When bypassing with capacitors of 10  $\mu\text{F}$  or more, it is good practice to place a smaller value capacitor in parallel with the larger to handle the high-frequency components of any line transients. Values in the range of 0.1  $\mu\text{F}$  to 1  $\mu\text{F}$  are recommended. Again, good quality, low-ESR capacitors, preferably ceramic, should be chosen.

### 4.3 $C_{OUT}$

An output capacitor is required to reduce ringing and voltage sag on the output during a transient condition. A value between 1  $\mu\text{F}$  and 10  $\mu\text{F}$  is recommended.

A 10  $\mu\text{F}$  or larger capacitor should be used if the distance between the MIC2090/MIC2091 and the load is greater than three inches. The internal switch in the MIC2090/MIC2091 turns off in (typically) 20 ns. This extremely fast turn-off can cause an inductive spike in the output voltage when the internal switch turns off during an overcurrent condition. The larger value capacitor prevents the output from glitching too low.

### 4.4 Limitations on $C_{OUT}$

The part may enter current limit when turning on with a large output capacitance, which is an acceptable condition. However, if the part remains in current limit for a time greater than  $t_{D\_FAULT}$ , the FAULT/ pin will assert low. The maximum value of  $C_{OUT}$  may be approximated by Equation 4-1.

#### EQUATION 4-1:

$$C_{OUT(MAX)} = \frac{I_{LIMIT(MIN)} \times t_{D\_FAULT(MIN)}}{V_{IN(MAX)}}$$

Where:

$I_{LIMIT(MIN)}$  = The minimum specified value in the [Electrical Characteristics](#) table.

$t_{D\_FAULT(MIN)}$  = The minimum specified value in the [Electrical Characteristics](#) table.

$V_{IN(MAX)}$  = The maximum input voltage to the switch.

### 4.5 Current Sensing and Limiting

The MIC2090/MIC2091 protects the system power supply and load from damage by continuously monitoring current through the on-chip power MOSFET. Load current is monitored by means of a current mirror in parallel with the power MOSFET switch. Current limiting is invoked when the load exceeds the overcurrent threshold. When current limiting is activated in the -1 version, the output current is constrained to the limit value, and remains at this level until either the load/fault is removed, the load's current requirement drops below the limiting value, or the switch goes into thermal shutdown. If the overcurrent fault is large enough to drop  $V_{OUT}$  below (typically) 1.8V, the internal MOSFET turns off very quickly (typically 20 ns). This prevents excessive current from flowing through the device and damaging the internal MOSFET.

The latch-off feature of the -2 version latches the output off when the output current exceeds the overcurrent threshold.  $V_{IN}$  or the enable pin must be toggled to reset the latch.

### 4.6 Enable Input

The EN pin is a TTL logic level compatible input that turns the internal MOSFET switch on and off. The FAULT/ pin remains high when the EN pin is pulled low and the output is turned off. Toggling the enable pin resets the output after an OGI (output greater than input) condition occurs. In the -2 version, toggling the enable pin resets the output after an overcurrent event.

# MIC2090/1

## 4.7 Fault/Output

The FAULT/ is an N-channel open-drain output that is asserted LOW when the MIC2090/MIC2091 switch either begins current-limiting or enters thermal shutdown.

During an overcurrent or short-circuit event, the FAULT/ signal asserts after a brief delay period,  $t_{D\_FAULT/}$ , in order to filter out false or transient overcurrent conditions.

The FAULT/ output is open-drain and must be pulled high with an external resistor. The FAULT/ signal may be wire-OR'd with other similar outputs, sharing a single pull-up resistor.

## 4.8 Power Dissipation and Thermal Shutdown

Thermal shutdown is used to protect the MIC2090/MIC2091 switch from damage should the die temperature exceed a safe operating temperature. Thermal shutdown shuts off the output MOSFET and asserts the FAULT/ output if the die temperature reaches the overtemperature threshold,  $T_{OVERTEMP}$ .

The switch will automatically resume operation when the die temperature cools down to 140°C. If resumed operation results in reheating of the die, another shutdown cycle will occur and the switch will continue cycling between ON and OFF states until the reason for the overcurrent condition has been resolved.

Depending upon the PCB layout, package type, ambient temperature, etc., hundreds of milliseconds may elapse from the time a fault occurs to the time the output MOSFET will be shut off. This delay is caused because of the time it takes for the die to heat after the fault condition occurs.

Power dissipation depends on several factors such as the load, PCB layout, ambient temperature, and supply voltage. Calculation of power dissipation can be accomplished by [Equation 4-2](#).

### EQUATION 4-2:

$$P_D = R_{DS(ON)} \times I_{OUT}^2$$

To relate this to junction temperature, Equation 4-3 can be used.

### EQUATION 4-3:

$$T_J = P_D \times R_{\theta(JA)} + T_A$$

Where:

$T_J$  = Junction temperature.

$T_A$  = Ambient temperature.

$R_{\theta(JA)}$  = Thermal resistance of the package.

In normal operation, excessive switch heating is most often caused by an output short-circuit. If the output is shorted, when the switch is enabled, the MIC2090/MIC2091 switch limits the output current to the maximum value. The heat generated by the power dissipation of the switch continuously limiting the current may exceed the package and PCB's ability to cool the device and the MIC2090/MIC2091 will shut down and signal a fault condition. Please see the "Fault Output" description for more details on the FAULT/ output.

After the MIC2090/MIC2091 shuts down, and cools, it will re-start itself if the enable signal remains true.

In [Figure 4-1](#), die temperature is plotted against  $I_{OUT}$  assuming a constant ambient temperature of +85°C and a worst case internal switch on-resistance ( $R_{ON}$ ). This plot is valid for both the MIC2090 and MIC2091.

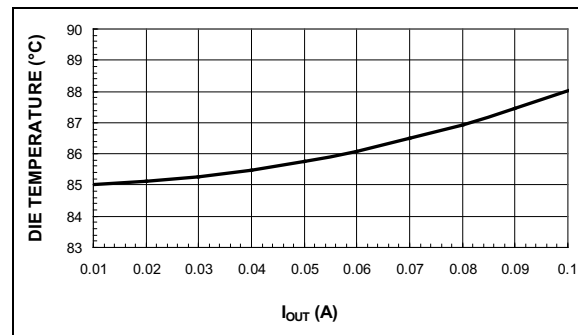


FIGURE 4-1: Die Temperature vs.  $I_{OUT}$ .

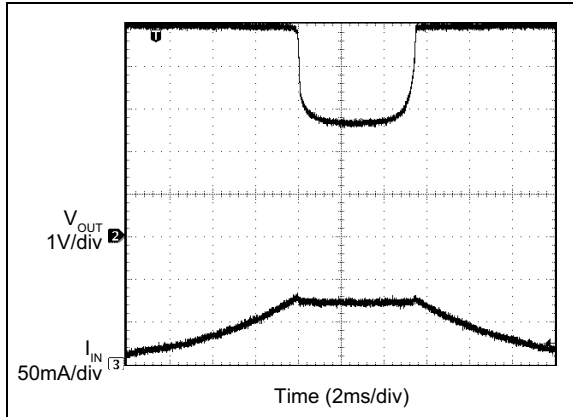
## 4.9 $I_{LIMIT}$ vs. $I_{OUT}$ Measured (-1 Version Only)

When the MIC2090/MIC2091 is current-limiting, it is designed to act as a constant current source to the load. As the load tries to pull more than the maximum current,  $V_{OUT}$  drops and the input to output voltage differential increases. When  $V_{OUT}$  drops below 1.8V, the output switch momentarily turns off to ensure the internal MOSFET switch is not damaged by a very fast short-circuit event.

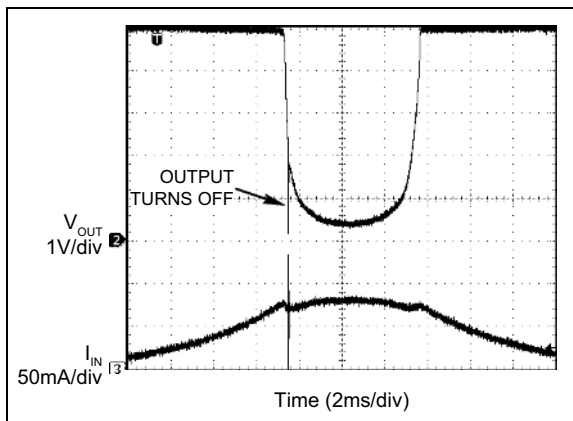
When measuring  $I_{OUT}$  in an overcurrent condition, it is important to remember voltage dependence, otherwise the measurement data may appear to indicate a problem when one does not really exist. This voltage dependence is illustrated in [Figure 4-2](#) and [Figure 4-3](#).

In [Figure 4-2](#), output current is measured as  $V_{OUT}$  is pulled below  $V_{IN}$ , with the test terminating when  $V_{OUT}$  is 2.5V below  $V_{IN}$ . Observe that once  $I_{LIMIT}$  is reached,  $I_{OUT}$  remains constant throughout the remainder of the test.

[Figure 4-3](#) repeats this test, but simulates operation deeper into an overcurrent condition. When  $V_{OUT}$  drops below 1.8V, the switch turns off for a few microseconds before turning back on.



**FIGURE 4-2:**  $I_{OUT}$  in Current-Limiting for  $V_{OUT} > 1.8V$ .



**FIGURE 4-3:**  $I_{OUT}$  in Current-Limiting for  $V_{OUT} < 1.8V$ .

## 4.10 Undervoltage Lockout (UVLO)

The MIC2090/MIC2091 switches have an Undervoltage Lockout (UVLO) feature that will shut down the switch in a reproducible way when the input power supply voltage goes too low. The UVLO circuit disables the output until the supply voltage exceeds the UVLO threshold. Hysteresis in the UVLO circuit prevents noise and finite circuit impedance from causing chatter during turn-on and turn-off. While disable by the UVLO circuit, the output switch (power MOSFET) is OFF and no circuit functions, such as FAULT/ or EN, are considered to be valid or operative.

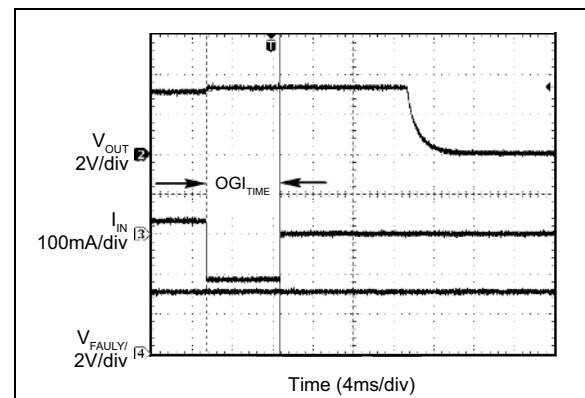
## 4.11 Output Greater than Input (OGI)

The internal MOSFET switch turns off when it senses an output voltage that is greater than the input voltage. This feature prevents continuous current from flowing from the output to the input.

If the output voltage rises above  $V_{IN}$  by the OGI threshold voltage (typically 85 mV), the internal MOSFET switch turns off after a period of time,

specified in the [Electrical Characteristics](#) table as  $OGI_{TIME}$ . The FAULT/ pin remains high during and after an OGI event.

Figure 4-4 shows the output voltage, input current, and FAULT/ pin voltage when the output voltage is raised above the input. Reverse current flows through the internal MOSFET switch for the  $OGI_{TIME}$  period, until the internal MOSFET switch is turned off and the input current goes to 0A.



**FIGURE 4-4:** OGI Event.

# MIC2090/1

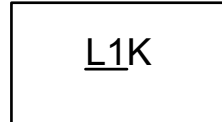
## 5.0 PACKAGING INFORMATION

### 5.1 Package Marking Information

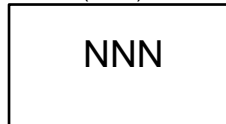
5-Lead SOT-23\*  
(Front)



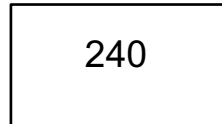
Example



5-Lead SOT-23\*  
(Back)



Example



Part Number	Marking
MIC2090-1YM5-TR	<u>L</u> 1K
MIC2090-2YM5-TR	<u>L</u> 2K
MIC2091-1YM5-TR	<u>M</u> 1K
MIC2091-2YM5-TR	<u>M</u> 2K

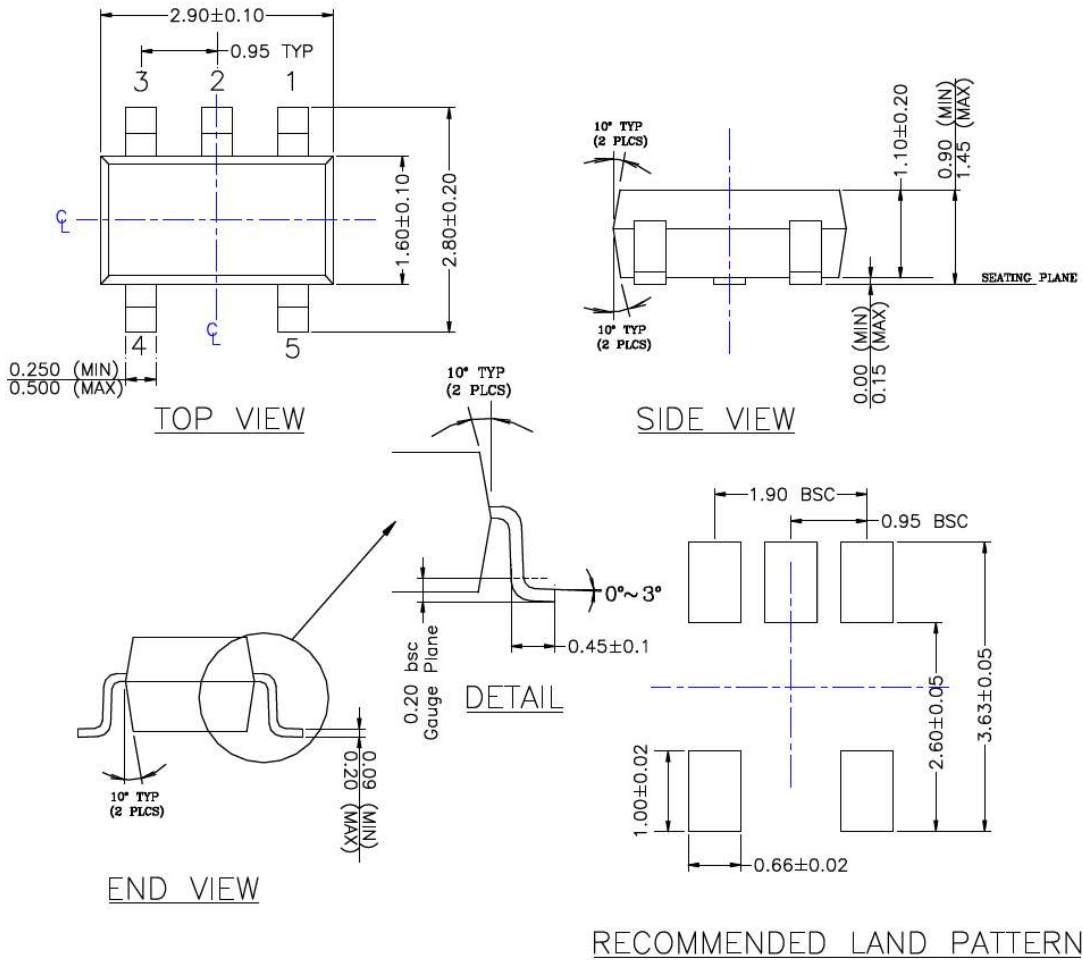
<p><b>Legend:</b> XX...X Product code or customer-specific information          Y Year code (last digit of calendar year)          YY Year code (last 2 digits of calendar year)          WW Week code (week of January 1 is week '01')          NNN Alphanumeric traceability code          (e3) Pb-free JEDEC® designator for Matte Tin (Sn)          * This package is Pb-free. The Pb-free JEDEC designator ((e3)) can be found on the outer packaging for this package.</p> <p>•, ▲, ▼ Pin one index is identified by a dot, delta up, or delta down (triangle mark).</p>
<p><b>Note:</b> In the event the full Microchip part number cannot be marked on one line, it will be carried over to the next line, thus limiting the number of available characters for customer-specific information. Package may or may not include the corporate logo.</p> <p>Underbar ( <u> </u> ) and/or Overbar ( <sup> </sup> ) symbol may not be to scale.</p>

## 5-Lead SOT-23 Package Outline and Recommended Land Pattern

**TITLE**

5 LEAD SOT23 PACKAGE OUTLINE & RECOMMENDED LAND PATTERN

<b>DRAWING #</b>	SOT23-5LD-PL-1	<b>UNIT</b>	MM
------------------	----------------	-------------	----



**NOTE:**

1. PACKAGE OUTLINE EXCLUSIVE OF MOLD FLASH & BURR.
2. PACKAGE OUTLINE INCLUSIVE OF SOLER PLATING.
3. DIMENSION AND TOLERANCE PER ANSI Y14.5M, 1982.
4. FOOT LENGTH MEASUREMENT BASED ON GAUGE PLANE METHOD.
5. DIE FACES UP FOR MOLD, AND FACES DOWN FOR TRIM/FORM.
6. ALL DIMENSIONS ARE IN MILLIMETERS.

Note: For the most current package drawings, please see the Microchip Packaging Specification located at <http://www.microchip.com/packaging>.

# MIC2090/1

---

---

NOTES:

## APPENDIX A: REVISION HISTORY

### Revision A (November 2021)

- Converted Micrel document MIC2090/1 to Microchip data sheet DS20006611A.
- Minor text changes throughout.

# MIC2090/1

---

---

NOTES:



## PRODUCT IDENTIFICATION SYSTEM

To order or obtain information, e.g., on pricing or delivery, contact your local Microchip representative or sales office.

Device	-X	X	XX	-XX
Part No.	Current-Limit Recovery	Junction Temp. Range	Package	Media Type
<p><b>Device:</b> MIC2090/MIC2091:Current-Limiting Power Distribution Switches</p>				
<b>Current-Limit Recovery:</b>	1 =	Auto-Retry		
	2 =	Latch-Off		
<b>Junction Temperature Range:</b>	Y =	-40°C to +125°C		
<b>Package:</b>	M5 =	5-Lead SOT-23		
<b>Media Type:</b>	TR =	3,000/Reel		
<p><b>Examples:</b></p> <p>a) MIC2090-1YM5-TR: MIC2090, Auto-Retry Current-Limit Recovery, -40°C to +125°C Temp. Range, 5-Lead SOT-23, 3,000/Reel</p> <p>b) MIC2090-2YM5-TR: MIC2090, Latch-Off Current-Limit Recovery, -40°C to +125°C Temp. Range, 5-Lead SOT-23, 3,000/Reel</p> <p>c) MIC2091-1YM5-TR: MIC2091, Auto-Retry Current-Limit Recovery, -40°C to +125°C Temp. Range, 5-Lead SOT-23, 3,000/Reel</p> <p>d) MIC2091-2YM5-TR: MIC2091, Latch-Off Current-Limit Recovery, -40°C to +125°C Temp. Range, 5-Lead SOT-23, 3,000/Reel</p>				
<p><b>Note 1:</b> Tape and Reel identifier only appears in the catalog part number description. This identifier is used for ordering purposes and is not printed on the device package. Check with your Microchip Sales Office for package availability with the Tape and Reel option.</p>				

# MIC2090/1

---

---

NOTES:

---

---

**Note the following details of the code protection feature on Microchip products:**

- Microchip products meet the specifications contained in their particular Microchip Data Sheet.
- Microchip believes that its family of products is secure when used in the intended manner, within operating specifications, and under normal conditions.
- Microchip values and aggressively protects its intellectual property rights. Attempts to breach the code protection features of Microchip product is strictly prohibited and may violate the Digital Millennium Copyright Act.
- Neither Microchip nor any other semiconductor manufacturer can guarantee the security of its code. Code protection does not mean that we are guaranteeing the product is “unbreakable”. Code protection is constantly evolving. Microchip is committed to continuously improving the code protection features of our products.

---

This publication and the information herein may be used only with Microchip products, including to design, test, and integrate Microchip products with your application. Use of this information in any other manner violates these terms. Information regarding device applications is provided only for your convenience and may be superseded by updates. It is your responsibility to ensure that your application meets with your specifications. Contact your local Microchip sales office for additional support or, obtain additional support at <https://www.microchip.com/en-us/support/design-help/client-support-services>.

THIS INFORMATION IS PROVIDED BY MICROCHIP "AS IS". MICROCHIP MAKES NO REPRESENTATIONS OR WARRANTIES OF ANY KIND WHETHER EXPRESS OR IMPLIED, WRITTEN OR ORAL, STATUTORY OR OTHERWISE, RELATED TO THE INFORMATION INCLUDING BUT NOT LIMITED TO ANY IMPLIED WARRANTIES OF NON-INFRINGEMENT, MERCHANTABILITY, AND FITNESS FOR A PARTICULAR PURPOSE, OR WARRANTIES RELATED TO ITS CONDITION, QUALITY, OR PERFORMANCE.

IN NO EVENT WILL MICROCHIP BE LIABLE FOR ANY INDIRECT, SPECIAL, PUNITIVE, INCIDENTAL, OR CONSEQUENTIAL LOSS, DAMAGE, COST, OR EXPENSE OF ANY KIND WHATSOEVER RELATED TO THE INFORMATION OR ITS USE, HOWEVER CAUSED, EVEN IF MICROCHIP HAS BEEN ADVISED OF THE POSSIBILITY OR THE DAMAGES ARE FORESEEABLE. TO THE FULLEST EXTENT ALLOWED BY LAW, MICROCHIP'S TOTAL LIABILITY ON ALL CLAIMS IN ANY WAY RELATED TO THE INFORMATION OR ITS USE WILL NOT EXCEED THE AMOUNT OF FEES, IF ANY, THAT YOU HAVE PAID DIRECTLY TO MICROCHIP FOR THE INFORMATION.

Use of Microchip devices in life support and/or safety applications is entirely at the buyer's risk, and the buyer agrees to defend, indemnify and hold harmless Microchip from any and all damages, claims, suits, or expenses resulting from such use. No licenses are conveyed, implicitly or otherwise, under any Microchip intellectual property rights unless otherwise stated.

For information regarding Microchip's Quality Management Systems, please visit [www.microchip.com/quality](http://www.microchip.com/quality).

**Trademarks**

The Microchip name and logo, the Microchip logo, Adaptec, AnyRate, AVR, AVR logo, AVR Freaks, BesTime, BitCloud, CryptoMemory, CryptoRF, dsPIC, flexPWR, HELDO, IGLOO, JukeBlox, KeeLoq, Kleer, LANCheck, LinkMD, maXStylus, maXTouch, MediaLB, megaAVR, Microsemi, Microsemi logo, MOST, MOST logo, MPLAB, OptoLyzer, PIC, picoPower, PICSTART, PIC32 logo, PolarFire, Prochip Designer, QTouch, SAM-BA, SenGenuity, SpyNIC, SST, SST Logo, SuperFlash, Symmetricom, SyncServer, Tachyon, TimeSource, tinyAVR, UNI/O, Vectron, and XMEGA are registered trademarks of Microchip Technology Incorporated in the U.S.A. and other countries.

AgileSwitch, APT, ClockWorks, The Embedded Control Solutions Company, EtherSynch, Flashtec, Hyper Speed Control, HyperLight Load, IntelliMOS, Libero, motorBench, mTouch, Powermite 3, Precision Edge, ProASIC, ProASIC Plus, ProASIC Plus logo, QuietWire, SmartFusion, SyncWorld, Temux, TimeCesium, TimeHub, TimePictra, TimeProvider, TrueTime, WinPath, and ZL are registered trademarks of Microchip Technology Incorporated in the U.S.A.

Adjacent Key Suppression, AKS, Analog-for-the-Digital Age, Any Capacitor, AnyIn, AnyOut, Augmented Switching, BlueSky, BodyCom, CodeGuard, CryptoAuthentication, CryptoAutomotive, CryptoCompanion, CryptoController, dsPICDEM, dsPICDEM.net, Dynamic Average Matching, DAM, ECAN, Espresso T1S, EtherGREEN, GridTime, IdealBridge, In-Circuit Serial Programming, ICSP, INICnet, Intelligent Paralleling, Inter-Chip Connectivity, JitterBlocker, Knob-on-Display, maxCrypto, maxView, memBrain, Mindi, MiWi, MPASM, MPF, MPLAB Certified logo, MPLIB, MPLINK, MultiTRAK, NetDetach, NVM Express, NVMe, Omniscient Code Generation, PICDEM, PICDEM.net, PICkit, PICtail, PowerSmart, PureSilicon, QMatrix, REAL ICE, Ripple Blocker, RTAX, RTG4, SAM-ICE, Serial Quad I/O, simpleMAP, SimpliPHY, SmartBuffer, SmartHLS, SMART-I.S., storClad, SQI, SuperSwitcher, SuperSwitcher II, Switchtec, SynchronPHY, Total Endurance, TSHARC, USBCheck, VariSense, VectorBlox, VeriPHY, ViewSpan, WiperLock, XpressConnect, and ZENA are trademarks of Microchip Technology Incorporated in the U.S.A. and other countries.

SQTP is a service mark of Microchip Technology Incorporated in the U.S.A.

The Adaptec logo, Frequency on Demand, Silicon Storage Technology, Symmcom, and Trusted Time are registered trademarks of Microchip Technology Inc. in other countries.

GestIC is a registered trademark of Microchip Technology Germany II GmbH & Co. KG, a subsidiary of Microchip Technology Inc., in other countries.

All other trademarks mentioned herein are property of their respective companies.

© 2021, Microchip Technology Incorporated and its subsidiaries.

All Rights Reserved.

ISBN: 978-1-5224-9279-5



# MICROCHIP

## Worldwide Sales and Service

### AMERICAS

**Corporate Office**  
2355 West Chandler Blvd.  
Chandler, AZ 85224-6199  
Tel: 480-792-7200  
Fax: 480-792-7277  
Technical Support:  
<http://www.microchip.com/support>  
Web Address:  
[www.microchip.com](http://www.microchip.com)

#### Atlanta

Duluth, GA  
Tel: 678-957-9614  
Fax: 678-957-1455

#### Austin, TX

Tel: 512-257-3370

#### Boston

Westborough, MA  
Tel: 774-760-0087  
Fax: 774-760-0088

#### Chicago

Itasca, IL  
Tel: 630-285-0071  
Fax: 630-285-0075

#### Dallas

Addison, TX  
Tel: 972-818-7423  
Fax: 972-818-2924

#### Detroit

Novi, MI  
Tel: 248-848-4000

#### Houston, TX

Tel: 281-894-5983

#### Indianapolis

Noblesville, IN  
Tel: 317-773-8323  
Fax: 317-773-5453  
Tel: 317-536-2380

#### Los Angeles

Mission Viejo, CA  
Tel: 949-462-9523  
Fax: 949-462-9608  
Tel: 951-273-7800

#### Raleigh, NC

Tel: 919-844-7510

#### New York, NY

Tel: 631-435-6000

#### San Jose, CA

Tel: 408-735-9110  
Tel: 408-436-4270

#### Canada - Toronto

Tel: 905-695-1980  
Fax: 905-695-2078

### ASIA/PACIFIC

**Australia - Sydney**  
Tel: 61-2-9868-6733

**China - Beijing**  
Tel: 86-10-8569-7000

**China - Chengdu**  
Tel: 86-28-8665-5511

**China - Chongqing**  
Tel: 86-23-8980-9588

**China - Dongguan**  
Tel: 86-769-8702-9880

**China - Guangzhou**  
Tel: 86-20-8755-8029

**China - Hangzhou**  
Tel: 86-571-8792-8115

**China - Hong Kong SAR**  
Tel: 852-2943-5100

**China - Nanjing**  
Tel: 86-25-8473-2460

**China - Qingdao**  
Tel: 86-532-8502-7355

**China - Shanghai**  
Tel: 86-21-3326-8000

**China - Shenyang**  
Tel: 86-24-2334-2829

**China - Shenzhen**  
Tel: 86-755-8864-2200

**China - Suzhou**  
Tel: 86-186-6233-1526

**China - Wuhan**  
Tel: 86-27-5980-5300

**China - Xian**  
Tel: 86-29-8833-7252

**China - Xiamen**  
Tel: 86-592-2388138

**China - Zhuhai**  
Tel: 86-756-3210040

### ASIA/PACIFIC

**India - Bangalore**  
Tel: 91-80-3090-4444

**India - New Delhi**  
Tel: 91-11-4160-8631

**India - Pune**  
Tel: 91-20-4121-0141

**Japan - Osaka**  
Tel: 81-6-6152-7160

**Japan - Tokyo**  
Tel: 81-3-6880-3770

**Korea - Daegu**  
Tel: 82-53-744-4301

**Korea - Seoul**  
Tel: 82-2-554-7200

**Malaysia - Kuala Lumpur**  
Tel: 60-3-7651-7906

**Malaysia - Penang**  
Tel: 60-4-227-8870

**Philippines - Manila**  
Tel: 63-2-634-9065

**Singapore**  
Tel: 65-6334-8870

**Taiwan - Hsin Chu**  
Tel: 886-3-577-8366

**Taiwan - Kaohsiung**  
Tel: 886-7-213-7830

**Taiwan - Taipei**  
Tel: 886-2-2508-8600

**Thailand - Bangkok**  
Tel: 66-2-694-1351

**Vietnam - Ho Chi Minh**  
Tel: 84-28-5448-2100

### EUROPE

**Austria - Wels**  
Tel: 43-7242-2244-39  
Fax: 43-7242-2244-393

**Denmark - Copenhagen**  
Tel: 45-4485-5910  
Fax: 45-4485-2829

**Finland - Espoo**  
Tel: 358-9-4520-820

**France - Paris**  
Tel: 33-1-69-53-63-20  
Fax: 33-1-69-30-90-79

**Germany - Garching**  
Tel: 49-8931-9700

**Germany - Haan**  
Tel: 49-2129-3766400

**Germany - Heilbronn**  
Tel: 49-7131-72400

**Germany - Karlsruhe**  
Tel: 49-721-625370

**Germany - Munich**  
Tel: 49-89-627-144-0  
Fax: 49-89-627-144-44

**Germany - Rosenheim**  
Tel: 49-8031-354-560

**Israel - Ra'anana**  
Tel: 972-9-744-7705

**Italy - Milan**  
Tel: 39-0331-742611  
Fax: 39-0331-466781

**Italy - Padova**  
Tel: 39-049-7625286

**Netherlands - Drunen**  
Tel: 31-416-690399  
Fax: 31-416-690340

**Norway - Trondheim**  
Tel: 47-7288-4388

**Poland - Warsaw**  
Tel: 48-22-3325737

**Romania - Bucharest**  
Tel: 40-21-407-87-50

**Spain - Madrid**  
Tel: 34-91-708-08-90  
Fax: 34-91-708-08-91

**Sweden - Gothenberg**  
Tel: 46-31-704-60-40

**Sweden - Stockholm**  
Tel: 46-8-5090-4654

**UK - Wokingham**  
Tel: 44-118-921-5800  
Fax: 44-118-921-5820