

1744109-4 ✓ ACTIVE



Economy Power

TE Internal #: 1744109-4

Rectangular Power Connectors, Header, Cap, Wire-to-Board, 9 Position, 3.96 mm [.156 in] Centerline, Printed Circuit Board, UL 94HB, Economy Power

[View on TE.com >](#)

Connectors > Power Connectors > Rectangular Power > Rectangular Power Connectors

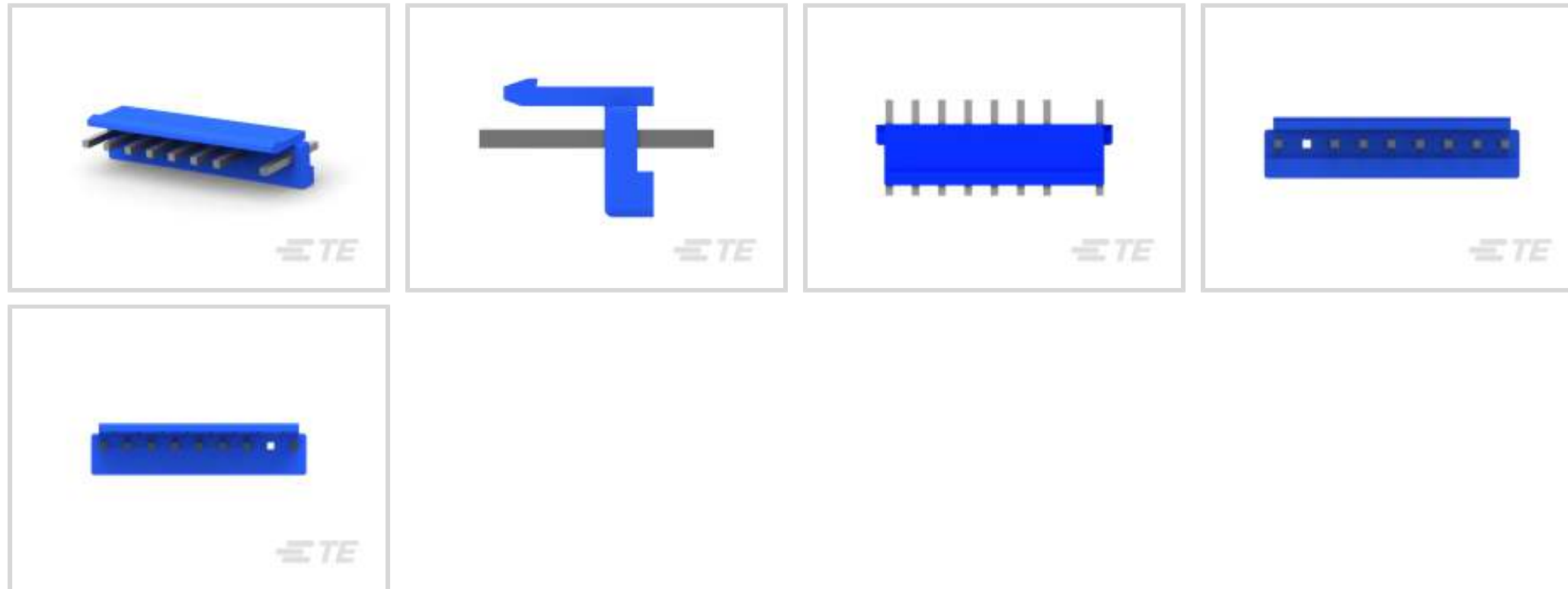

Rectangular Power Connector Type: **Header**

Connector & Housing Type: **Cap**

Connector System: **Wire-to-Board**

Number of Positions: **9**

Centerline (Pitch): **3.96 mm [.156 in]**

Features

Product Type Features

Header Type	Partially Shrouded
Rectangular Power Connector Type	Header
Connector & Housing Type	Cap
Connector System	Wire-to-Board
Sealable	No
Connector & Contact Terminates To	Printed Circuit Board

Configuration Features

Number of Positions	9
PCB Mount Orientation	Vertical
Number of Power Positions	9
Number of Rows	1

Electrical Characteristics

Operating Voltage	250 VDC
-------------------	---------

Contact Features



Mating Post Length	7.7 mm[.303 in]
PCB Contact Termination Area Plating Material Thickness	1 µm[39.36 µin]
Contact Layout	Inline
Contact Mating Area Plating Material	Tin
Contact Base Material	Brass
Contact Current Rating (Max)	8 A
Contact Retention Within Housing	Without
Contact Type	Pin
PCB Contact Termination Area Plating Material	Tin
Contact Mating Area Plating Material Thickness	1 µm[39.37 µin]

Termination Features

Termination Post & Tail Length	3.7 mm[.145 in]
Termination Method to Printed Circuit Board	Through Hole - Solder

Mechanical Attachment

Strain Relief	Without
Mating Retention	With
Mating Alignment	Without
PCB Mount Alignment	Without
Panel Mount Feature	Without
PCB Mount Retention	Without
Mating Retention Type	Latch
Connector Mounting Type	Board Mount

Housing Features

Centerline (Pitch)	3.96 mm[.156 in]
Housing Color	Natural
Housing Material	PBT GF

Dimensions

Product Width	8.5 mm[.334 in]
Product Length	35.58 mm[1.4 in]

Usage Conditions

Operating Temperature Range	-25 – 105 °C[-13 – 221 °F]
-----------------------------	----------------------------

Operation/Application



Circuit Application	Power
---------------------	-------

Industry Standards

UL Flammability Rating	UL 94HB
Glow Wire Rating	Standard Part - Not Glow Wire

Packaging Features

Packaging Method	Bag
------------------	-----

Product Compliance

[For compliance documentation, visit the product page on TE.com>](#)

EU RoHS Directive 2011/65/EU	Compliant
EU ELV Directive 2000/53/EC	Compliant
China RoHS 2 Directive MIIT Order No 32, 2016	No Restricted Materials Above Threshold
EU REACH Regulation (EC) No. 1907/2006	Current ECHA Candidate List: JUNE 2023 (235) Candidate List Declared Against: JAN 2021 (211) Does not contain REACH SVHC
Halogen Content	Not Low Halogen - contains Br or Cl > 900 ppm.
Solder Process Capability	Wave solder capable to 265°C

Product Compliance Disclaimer

This information is provided based on reasonable inquiry of our suppliers and represents our current actual knowledge based on the information they provided. This information is subject to change. The part numbers that TE has identified as EU RoHS compliant have a maximum concentration of 0.1% by weight in homogenous materials for lead, hexavalent chromium, mercury, PBB, PBDE, DBP, BBP, DEHP, DIBP, and 0.01% for cadmium, or qualify for an exemption to these limits as defined in the Annexes of Directive 2011/65/EU (RoHS2). Finished electrical and electronic equipment products will be CE marked as required by Directive 2011/65/EU. Components may not be CE marked. Additionally, the part numbers that TE has identified as EU ELV compliant have a maximum concentration of 0.1% by weight in homogenous materials for lead, hexavalent chromium, and mercury, and 0.01% for cadmium, or qualify for an exemption to these limits as defined in the Annexes of Directive 2000/53/EC (ELV). Regarding the REACH Regulation, the information TE provides on SVHC in articles for this part number is based on the latest European Chemicals Agency (ECHA) 'Guidance on requirements for substances in articles' posted at this URL: <https://echa.europa.eu/guidance-documents/guidance-on-reach>

Compatible Parts



Also in the Series | Economy Power

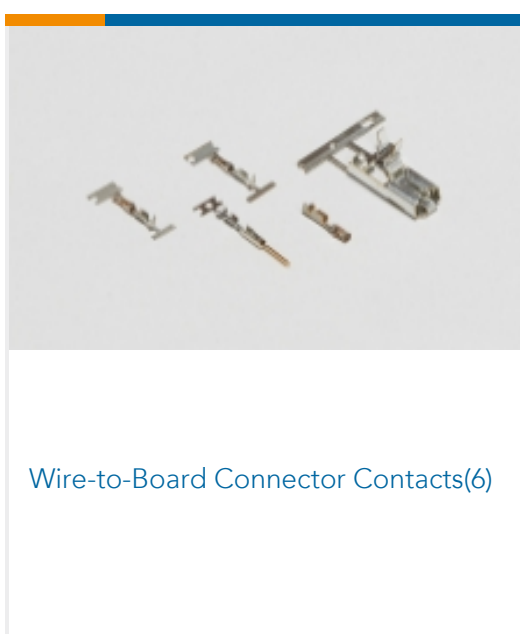
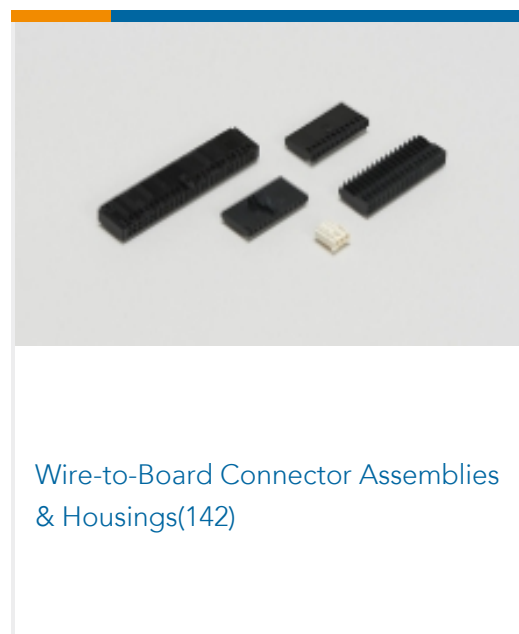
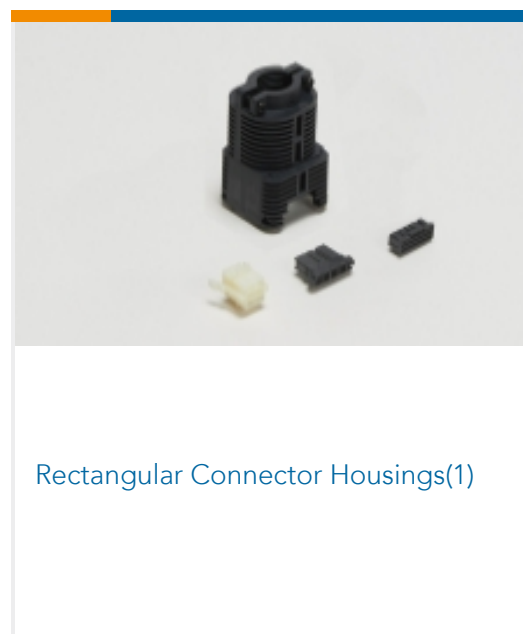
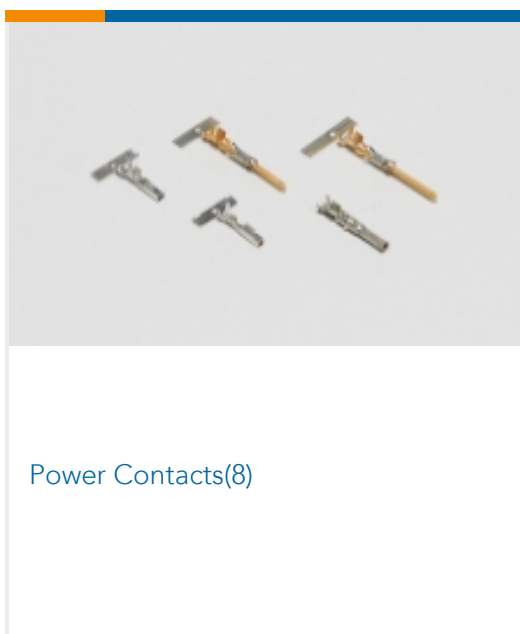
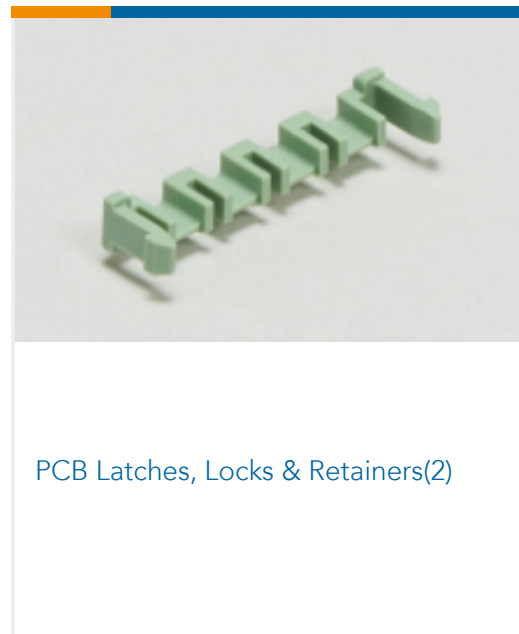
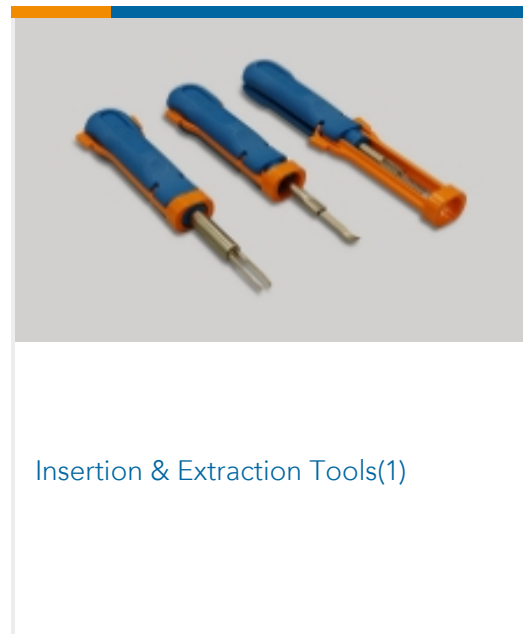
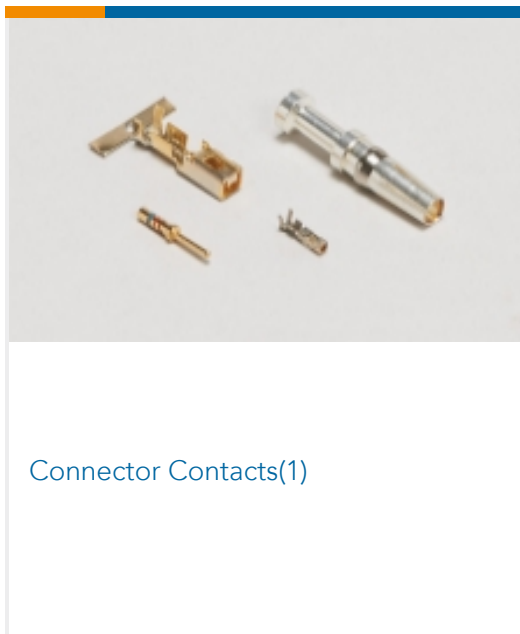

Customers Also Bought



TE Part #440052-6
AMP HPI 2.5 mm Headers

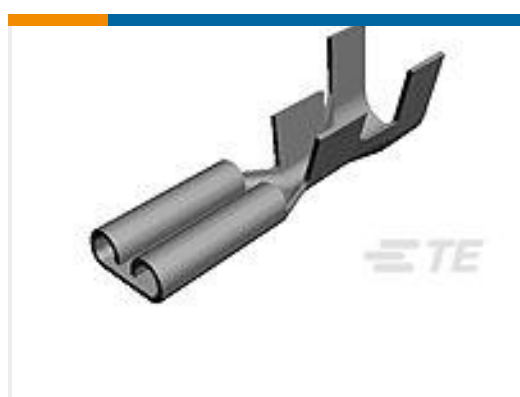

TE Part #42579-1
250 FASTON REC 16-12 AWG NPST



TE Part #63674-1
250 FASTON REC 18-14 AWG NPST



TE Part #2-1123723-4
3.96 EP HDR ASSY 4P(YELLOW)



TE Part #1534073-3
MULTIFIT MK2 ASSY3P



TE Part #2309279-5
05P EP SHRD HDR ASY,NO 2 PIN,
WHITE

Documents

CAD Files

3D PDF

3D

Customer View Model

[ENG_CVM_CVM_1744109-4_C.2d_dxf.zip](#)

English

Customer View Model

[ENG_CVM_CVM_1744109-4_C.3d_igs.zip](#)

English

Customer View Model

[ENG_CVM_CVM_1744109-4_C.3d_stp.zip](#)

English

By downloading the CAD file I accept and agree to the [Terms and Conditions](#) of use.

Product Specifications

[Application Specification](#)

English