



INVENTEK SYSTEMS

ISM43903-R48-L54

eS-WiFi™

(embedded Serial-to-WiFi),

**802.11 b/g/n + embedded Cortex R4 + Certified Antenna
Module Data Sheet**

Table of Contents

1	GENERAL DESCRIPTION	3
2	PART NUMBER DETAIL DESCRIPTION	5
2.1	Ordering Information	5
3	CERTIFICATIONS	6
3.1	Limitations	6
3.2	Regulatory Compliance	6
3.3	FCC and IC User’s Manual Statements:	6
4	COMPLEMENTARY DOCUMENTATION	9
4.1	Inventek Systems	9
5	SPECIFICATIONS	9
5.1	Block Diagram	9
5.2	External Antenna Connections	10
5.3	Mechanical Specifications	10
5.4	Environmental Specifications	10
6	HARDWARE ELECTRICAL SPECIFICATIONS	11
6.1	Recommended Operating Ratings	11
6.2	Power Consumption	11
7	PIN DESCRIPTION	12
7.1	+10 Pins	13
8	FIRMWARE UPGRADES DURING DEVELOPMENT	13
9	SERIAL HOST INTERFACES AVAILABLE	14
9.1	UART	14
9.1.1	Data Mode	14
9.1.2	Flow Control	14
9.1.3	Supported Baud Rates	14
9.1.4	Default Serial Configuration	14
9.2	GPIO	15
10	Wi-Fi RF SPECIFICATION	15
10.1	RF Specification	15
11	ANTENNA	16
11.1	External Antenna	16
11.2	Mechanical Specifications	17
12	ISM43903-R48-L54 FOOTPRINT	18
12.1	ISM43903-R48-L54 eS-WiFi Module’s Dimensions top view (mm)	18
13	PRODUCT COMPLIANCE CONSIDERATIONS	19
14	REFLOW PROFILE	19
15	PACKING INFORMATION	20
15.1	MSL Level / Storage Condition	20
15.2	Device baking requirements prior to assembly	20
16	TEMP. RATING	21
17	REVISION CONTROL	21
18	CONTACT INFORMATION	22

1 GENERAL DESCRIPTION

The Inventek ISM43903-R48-L54 is an embedded Serial WiFi (**eS-WiFi**), wireless internet connectivity module that operates in the 2.4 GHz spectrum. The **eS-WiFi** module's hardware consists of an ARM Cortex-based applications processor, a single stream IEEE 802.11n MAC/baseband/radio, a power amplifier (PA), and a receive low-noise amplifier (LNA). The **eS-WiFi** module has two antenna options, an on board PCB etched antenna or an U.FL connector for external 2.4 GHz antenna.

The **eS-WiFi** module provides a UART interface enabling connection to an embedded design. The **eS-WiFi** module requires no operating system and has a completely integrated TCP/IP Stack. The **eS-WiFi** module hardware can be used with Inventek's **IWIN** (Inventek Wireless Interoperability Network), **IWIN** AT Command set or with Cypress' WICED™ SDK4.x or later.

Inventek's **IWIN**, AT command set, allows you to quickly establish connectivity for your wireless product, minimizing development time, testing routines and certification. The low cost, small foot print (14.5 mm x 30 mm) and ease of design-in make it ideal for a range of embedded applications.

Hardware Features:

- ARM Cortex-R4 clocked at 160 MHz (in 1× mode) or up to 320 MHz (in 2× mode).
- 1 MB of SRAM and 640 KB ROM available for the applications processor.
- One high-speed 4-wire UART interface with operation up to 4 Mbps.
- Two low-speed 2-wire UART interfaces multiplexed on general purpose I/O (GPIO) pins.
- Two dedicated BSC1 interfaces.
- Two SPI master/slave interfaces with operation up to 24 MHz
- U.FL Connector for external 2.4 GHz Antenna
- Configurable using **IWIN** AT commands.
- Host interface: UART
- 44-Pin and L44+10 Land Grid Array Footprint
- 14.5mm x 30mm x 2.5 mm
- 17 GPIO's
- Input Voltage: 3.3 V
- Low power operation with built-in low power modes.
- Proven Interoperability ... Connects with other vendor's a/b/g/n Access Points in the Wireless LAN.

Firmware Features:

- **IWIN** AT command Set/ API's for any External Host (UART)
- Hardware Supported by Cypress WICED™ SDK 3.5.2 or later.
- Secure Wi-Fi authentication WEP-128, WPA-PSK (TKIP), WPA2-PSK.
- Fully contained TCP/IP stack minimizing host CPU requirements.
- Network features: ICMP (Ping), ARP, DHCP, TCP, UDP.
- SSL3.0/TLS1.0/1.1/1.2 Security Library.
- Several Cloud Agents supported
- Configuration Webpage for Connecting to Networks
- Support for Web Service API for iOS and Android that allows easy connection with no web browser required.
- AP Auto-Channel Selection Algorithm in Congested and Overlapping Signal Environments
- Wi-Fi Protected Setup (WPS) Support
- SoftAP and Client Modes – Simultaneous Support
- Support for up to Four Simultaneous Sockets
- Supports up to 3 Connected Clients in SoftAP Mode
- Domain Name System –DNS Support
- mDNS Multicast Support
- Bootloader for the **eS-WiFi** Module Updates

Typical Applications:

- PDA, Pocket PC, computing devices.
- Building automation and smart energy control.
- Industrial sensing and remote equipment monitoring.
- Warehousing, logistics and freight management.
- PC and gaming peripherals.
- Printers, scanners, alarm and video systems.
- Medical applications including patient monitoring and remote diagnostics.

2 PART NUMBER DETAIL DESCRIPTION

2.1 Ordering Information

ISM43903-R48-L54-X X - I.I.I-C.Z.Z.Z.Z

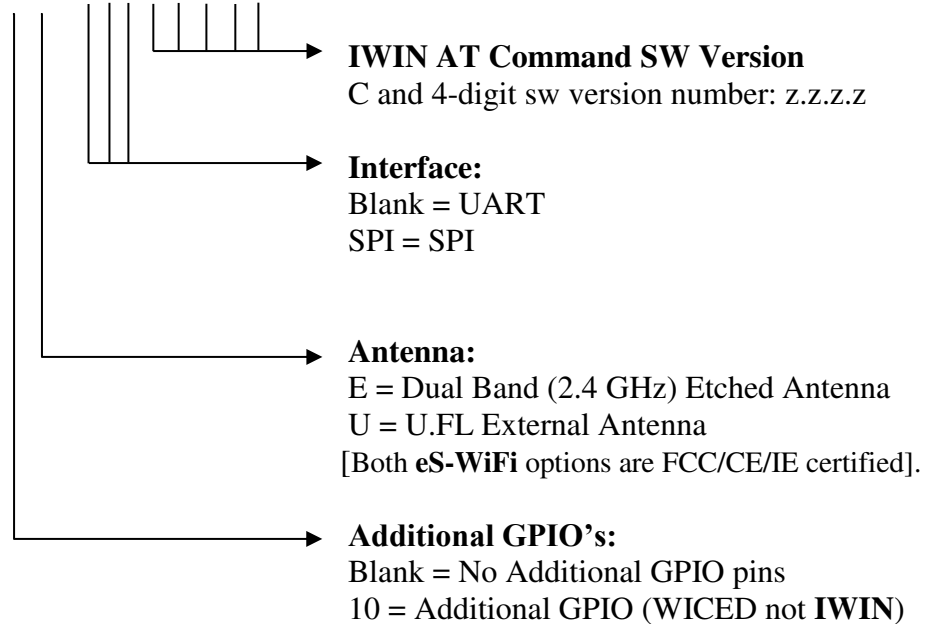

Evaluation Boards			
eS-WiFi -43903 EVB	Inventek eS-WiFi (embedded Serial Wi-Fi), Evaluation Board, USB cable, with ISM43903-R48-L54 module.	<ul style="list-style-type: none"> • USB Com. Port (UART) & JTAG • USB to eS-WiFi 	ISM43903-R48-L54 eS-WiFi module. Evaluation Board
ISMA RT-43903 EVB	Inventek ISMA RT (Inventek S ystems M odule A rduino T est), EVB with ISM43903-R48-L54 module.	<ul style="list-style-type: none"> • USB Com. Port (UART) & JTAG 	ISM43903-R48-L54 eS-WiFi module. Evaluation Board

3 CERTIFICATIONS

3.1 Limitations

Inventek Systems products are not authorized for use in safety-critical applications (such as life support) where a failure of the Inventek Systems product would reasonably be expected to cause severe personal injury or death.

3.2 Regulatory Compliance



Regulator	Status
FCC	O7P-903 (In process)
IC	10147A-903 (In Process)
RoHS	Compliant

3.3 FCC and IC User's Manual Statements:

OEM INSTRUCTIONS:

This **eS-WiFi** module is limited to OEM installation only.

OEM integrators must ensure that the end-user has no manual instructions to remove or install the **eS-WiFi** module. OEM's must comply with FCC marking regulation part 15 declaration of conformity (Section 2.925(e)).

This **eS-WiFi** module is to be installed only in mobile or fixed applications (Please refer to FCC CFR 47 Part 2.1091(b) for a definition of mobile and fixed devices).

Separate approval is required for all other operating configurations, including portable configurations with respect to FCC CFR 47 Part 2.1093, and different antenna configurations.

The antennas used with this **eS-WiFi** module must be installed to provide a separation distance of at least 20cm from all persons, and must not be co-located or transmit simultaneously with any other antenna or transmitter, except in accordance with FCC multi transmitter product procedures.

The ISM43903-R48-L54 **eS-WiFi** Module has been designed to operate with the following antennas and gains. Use with other antenna types or with these antenna types at higher gains is strictly prohibited.

Manufacturer	Type of Antenna	Model	Type of Connector
Inventek	U.FL port Antenna	ISM43903-R48-L54-U	U.FL
Inventek	PCB Etched	ISM43903-R48-L54-E	PCB etch

FCC Notice-

This device complies with Part 15 of the FCC rules. Operation is subject to the following two conditions: (1) this device may not cause harmful interference, and (2) this device must accept any interference received, including interference that may cause undesired operation.

Note: This equipment has been tested and found to comply with the limits for a Class B digital device, pursuant to part 15 of the FCC Rules. These limits are designed to provide reasonable protection against harmful interference in a residential installation. This equipment generates uses and can radiate radio frequency energy and, if not installed and used in accordance with the instructions, may cause harmful interference to radio communications.

However, there is no guarantee that interference will not occur in a particular installation. If this equipment does cause harmful interference to radio or television reception, which can be determined by turning the equipment off and on, the user is encouraged to try to correct the interference by one or more of the following measures:

- Reorient or relocate the receiving antenna.
- Increase the separation between the equipment and receiver.
- Connect the equipment into an outlet on a circuit different from that to which the receiver is connected.
- Consult the dealer or an experienced radio/TV technician for help.

Warning: changes or modifications not expressly approved by the party responsible for compliance could void the user's authority to operate this equipment.

A clearly visible label is required on the outside of the user's (OEM) enclosure stat the following text:

Contains FCC ID: O7P-903

Contains IC: 10147A-903

This transmitter module has been certified for FCC Part 15 operation; when installed in a host device, the host manufacturer is responsible for making sure that the host device with the transmitter installed continues to be compliant with Part 15B unintentional radiator requirements.

Industry Canada User's Manual Statements:

IC RSS-210/RSS-Gen Notices-

Operation is subject to the following two conditions: (1) this device may not cause interference, and (2) this device must accept any interference, including interference that may cause undesired operation of this device.

L'opération est soumise aux deux conditions suivantes: (1) cet appareil ne peut pas provoquer d'interférences et (2) cet appareil doit accepter toute interférence, y compris les interférences qui peuvent causer un mauvais fonctionnement de l'appareil.

Under Industry Canada regulations, this radio transmitter may only operate using an antenna of a type and maximum (or lesser) gain approved for the transmitter by Industry Canada. To reduce potential radio interference to other users, the antenna type and its gain should be so chosen that the equivalent isotropically radiated power (e.i.r.p.) is not more than that necessary for successful communication.

Sous la réglementation d'Industrie Canada, ce transmetteur radio ne peut fonctionner en utilisant une antenne d'un type et un maximum (ou moins) gain approuvées pour l'émetteur par Industrie Canada. Pour réduire le risque d'interférence aux autres utilisateurs, le type d'antenne et son gain doivent être choisis de manière que la puissance isotrope rayonnée équivalente (PIRE) ne dépasse pas ce qui est nécessaire pour une communication réussie.

The radio transmitter has been approved by Industry Canada to operate with the antenna types listed above with the maximum permissible gain and required antenna impedance for each antenna type indicated. Antenna types not included in this list having a gain greater than the maximum gain indicated for that type, are strictly prohibited for use with this device.

Cet émetteur de radio a été approuvé par Industrie Canada pour fonctionner avec les types d'antennes énumérées ci-dessus avec le gain maximal admissible et impédance d'antenne requise pour chaque type d'antenne indiquée. Types d'antennes ne figurant pas dans cette liste, ayant un gain supérieur au gain maximum indiquée pour ce type, sont strictement interdites pour l'utilisation avec cet appareil.

4 COMPLEMENTARY DOCUMENTATION

4.1 Inventek Systems

- Evaluation Board Documentation: <http://www.inventeksys.com/products-page/wifi-modules/serial-wifi/ism43903-r48-l54/>
 - ISM43903-R48-L54 Data Sheet
 - eS-WiFi EVB Quick Start Guide
 - eS-WiFi EVB User's Manual
 - eS-WiFi EVB PC Demo software (includes EVB Drivers and Firmware)
 - eS-WiFi EVB Demo Software Help
- IWIN AT Command Set Documentation
 - IWIN AT Command Set User's Manual
 - IWIN AT Command Set Quick Reference Guide
 - IWIN AT Command Sample Scripts Firmware
- OrCAD Schematic Symbol
- PADS Land Pattern
- FCC Test Report

5 SPECIFICATIONS

5.1 Block Diagram

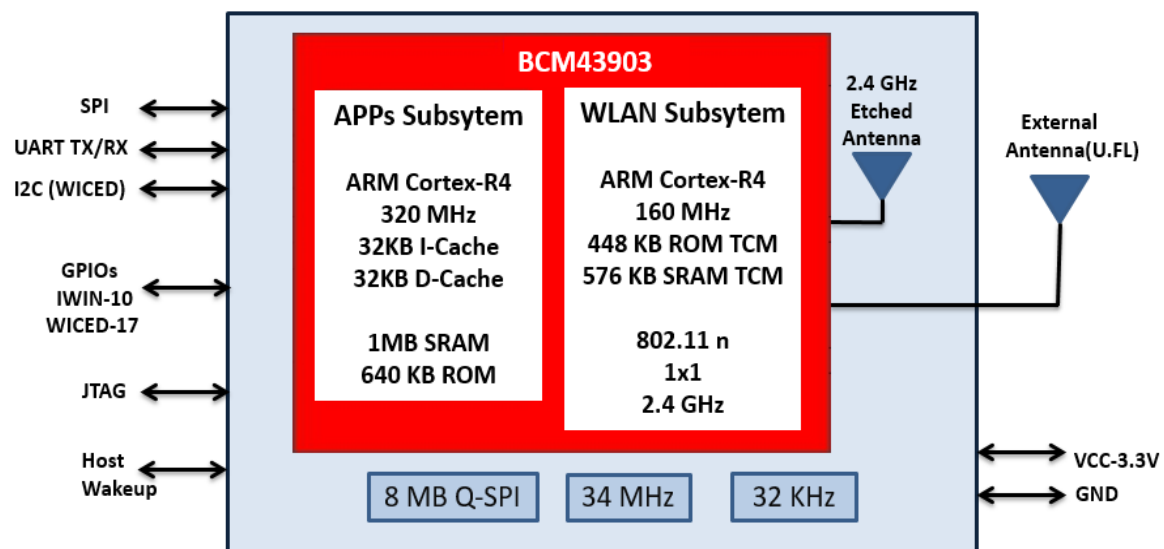

5.2 External Antenna Connections

ISM43903-R48-L54-U **eS-WiFi** module is designed for use with an external antenna via a connection using the U.FL connector.

Item	Description
Connector	U.FL series
Manufacturer	I-PEX Co., Ltd.
Part No.	20279-001E-01
Height	1.25 mm
Width	2 mm
DC	3.0 – 5.0 V

Table 1 On-Board Antenna Connector

5.3 Mechanical Specifications

The Physical dimensions of this **eS-WiFi** Module are as follow:

Items	Description
	ISM43903-R48-L54
Length	30 mm (-/+0.5 mm)
Width	14.5 mm (-/+0.5 mm)
Height	2.5 ± 0.2 mm
Package	44 pin LGA +10 pin

5.4 Environmental Specifications

Item	Description
Operating temperature range	-40 deg. C to +85 deg. C
Storage temperature range	-40 deg. C to +85 deg. C
Humidity	95% max non-condensing

Note 1: The ISM43903-R48-L54 supports a functional operating range of -40°C to +85°C. However the optimal RF performance specified in this data sheet is only guaranteed for temperatures from -10°C to +65°C

6 HARDWARE ELECTRICAL SPECIFICATIONS

6.1 Recommended Operating Ratings

Symbol	Min.	Typ.	Max.	Unit.
VIO	1.8	3.3	3.6	V
VBAT	3.0	3.3	4.8	V

Note:

- If a separate VBAT supply is not being used, then connect VBAT and VIO together.
- **Please place a 10-15uF Bulk CAP as close to the module as possible to VBAT**

6.2 Power Consumption

Mode	Description	Typical	Max	Unit
Radio Off	Powered			mA
Radio On	Not Connected to Network			mA
Radio On	Connected to Network			mA
Power Save Mode	Connected to Network			mA
Absolute Max	Worst Case			mA

Note:

^[1] Wi-Fi On, and connected to a network: Max 120 mA (500 mA burst of less than 5 ms)

7 PIN DESCRIPTION

Pin No.	Type	Pin Definition	Descriptions
1	G	GND	Ground
2	I	VDD	3.3V
3	G	GND	Ground
4	I/O	TMS	JTAG
5	I/O	TCK	JTAG
6	I/O	TDI	JTAG
7	I/O	TD0	JTAG
8	I/O	TDRSTN	JTAG
9	I/O	SPI_MOSI	SPI
10	I/O	SPI_MISO	SPI
11	I/O	SPI_SCK	SPI
12	I/O	SPI_SSN	SPI
13	I/O	SPI_DATARDY	SPI
14	I	VDD	3.3V
15	I	VBAT	3.3V
16	I	Wakeup	HIB_WAKEUP
17	G	GND	Ground
18	O	UART0_RTS	UART0
19	I	UART0_CTS	UART0
20	G	GND	Ground
21	I	UART0_RX	UART0
22	I/O	UART0_TX	UART0
23	I/O	GPIO	BCM_GPIO0
24	I/O	GPIO	BCM_GPIO1
25	I/O	GPIO	BCM_GPIO8
26	I/O	GPIO	BCM_GPIO9
27	I/O	GPIO	BCM_GPIO10
28	I/O	GPIO	BCM_RF_SW_CTRL_7
29	I/O	GPIO	BCM_RF_SW_CTRL_6
30	I/O	GPIO	BCM_GPIO14
31	I/O	GPIO	BCM_GPIO12

Pin No.	Type	Pin Definition	Descriptions
32	I/O	GPIO 0	BCM_GPIO13
33	I/O	GPIO 1	BCM_GPIO15
34	I	RSTN	Reset
35	G	GND	Ground
36	G	GND	Ground
37	G	GND	Ground
38	G	GND	Ground
39	G	GND	Ground
40	G	GND	Ground
41	G	GND	Ground
42	G	GND	Ground
43	G	GND	Ground
44	G	GND	Ground

7.1 +10 Pins

Pin No.	Type	Pin Definition	Descriptions
45	I/O	GPIO	Alternate Function: BCM_GPIO16
46	I/O	GPIO	Alternate Function: BCM_GPIO11
47	-	NC	
48	I/O	GPIO	Alternate Function: BCM_RF_SW_CTL_8
49	I/O	GPIO	Alternate Function: BCM_RF_SW_CTL_9
50	-	NC	
51	-	NC	
52	I/O	GPIOH	Alternate Function: BCM_I2C_0_SCL
53	I/O	GPIO	Alternate Function: BCM_I2C_0_SDA
54	-	NC	

8 FIRMWARE UPGRADES DURING DEVELOPMENT

We recommend using a JTAG 10 pin header or directly connecting to the JTAG pins on the **eS-WiFi** module for updating.

9 SERIAL HOST INTERFACES AVAILABLE

UART and SPI host interfaces are supported and unique firmware is required for each interface. SPI host interface is under development, please contact Inventek Systems for more information.

9.1 UART

A high-speed 4-wire CTS/RTS UART interface is enabled as the host interface. It is compatible with the industry standard 16550 UART and provides a FIFO size of 64×8 in each direction.

9.1.1 Data Mode

When the **eS-WiFi** module is interfaced serially, the serial interface needs to be configured for 8 bit data, no parity, and one stop bit -- (8-n-1).

9.1.2 Flow Control

The eS-WiFi module and WICED do not require or support Flow Control, so Flow Control should not be implemented.

9.1.3 Supported Baud Rates

The **eS-WiFi** module uses USART0 and the following serial baud rates are supported: 1200, 2400, 4800, 9600, 19200, 38400, 57600, 115200, 230400, 460800, 921600, 1152000, 1382400, 1612800, 1834200, 2073600, 2304000, 2764800, 3686400, 3910800. Please note that higher baud read does not always correlate to higher throughput.

9.1.4 Default Serial Configuration

The **eS-WiFi** module is shipped with the default serial configuration of 115200 baud, 8 data bits, no party, and 1 stop bits.

9.2 GPIO

There are 17 GPIO's supported, each of the GPIO pins can be configured by the **IWIN** AT command set as Button, LED, Digital input or Digital output.

10 Wi-Fi RF SPECIFICATION

10.1 RF Specification

Conditions: VDD=3.3V; VDDIO=3.3V; TEMP: 25°C

Feature	Description
WLAN Standard	IEEE 802.11b/g/n, Wi-Fi compliant
Frequency Range	2.400 GHz ~ 2.497 GHz (2.4 GHz ISM Band)
Number of Channels	Ch1 ~ Ch14
Modulation	802.11 g/n : OFDM /64-QAM,16-QAM, QPSK, BPSK 802.11b : CCK, DQPSK, DBPSK
Output Power	802.11b /11Mbps : 17 dBm ± 1.5 dB
	802.11g /54Mbps: 17* dBm ± 1.5 dB
	802.11n /72Mbps: 16* dBm ± 1.5 dB
Receive Sensitivity (11n,20MHz) @10% PER	- MCS=0 PER @ -86 dBm, typical
	- MCS=1 PER @ -85 dBm, typical
	- MCS=2 PER @ -85 dBm, typical
	- MCS=3 PER @ -84 dBm, typical
	- MCS=4 PER @ -80 dBm, typical
	- MCS=5 PER @ -78 dBm, typical
	- MCS=6 PER @ -72 dBm, typical
- MCS=7 PER @ -69 dBm, typical	
Receive Sensitivity (11g) @10% PER	- 6Mbps PER @ -89 dBm, typical
	- 9Mbps PER @ -88 dBm, typical
	- 12Mbps PER @ -88 dBm, typical
	- 18Mbps PER @ -87 dBm, typical
	- 24Mbps PER @ -83 dBm, typical
	- 36Mbps PER @ -80 dBm, typical
	- 48Mbps PER @ -75 dBm, typical
- 54Mbps PER @ -72 dBm, typical	

Receive Sensitivity (11b) @10% PER	- 1Mbps PER @ -93 dBm, typical
	- 2Mbps PER @ -91 dBm, typical
	- 5.5Mbps PER @ -89 dBm, typical
	- 11Mbps PER @ -87 dBm, typical
Data Rates	802.11b : 1, 2, 5.5, 11Mbps
	802.11g : 6, 9, 12, 18, 24, 36, 48, 54Mbps
Data Rate (20MHz ,Long GI,800ns)	802.11n: 6.5, 13, 19.5, 26, 39, 52, 58.5, 65Mbps
Data Rate (20MHz ,short GI,400ns)	802.11n : 7.2, 14.4, 21.7, 28.9, 43.3, 57.8, 65,72.2Mbps
Maximum Input Level	802.11b : -10 dBm
	802.11g : -10 dBm

11 ANTENNA

11.1 External Antenna

The Inventek U.FL PCB antenna is certified for FCC, IC and CE. The part number is W2.4-PU. It is a dual band 2.4 Ghz PCB antenna with a U.FL connector.

The Inventek W2.4-PU PCB antenna datasheet can be found on the Inventek Website.



11.2 Mechanical Specifications

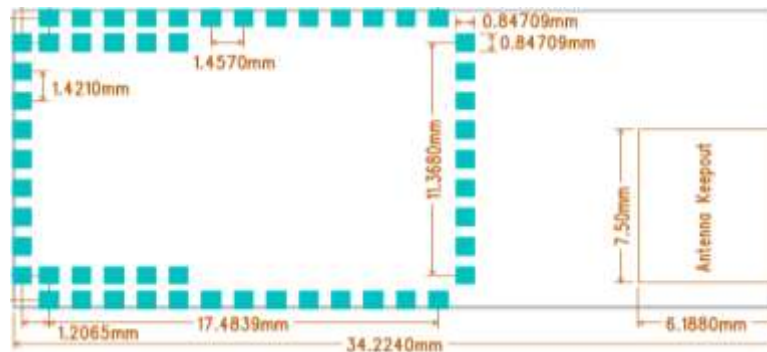
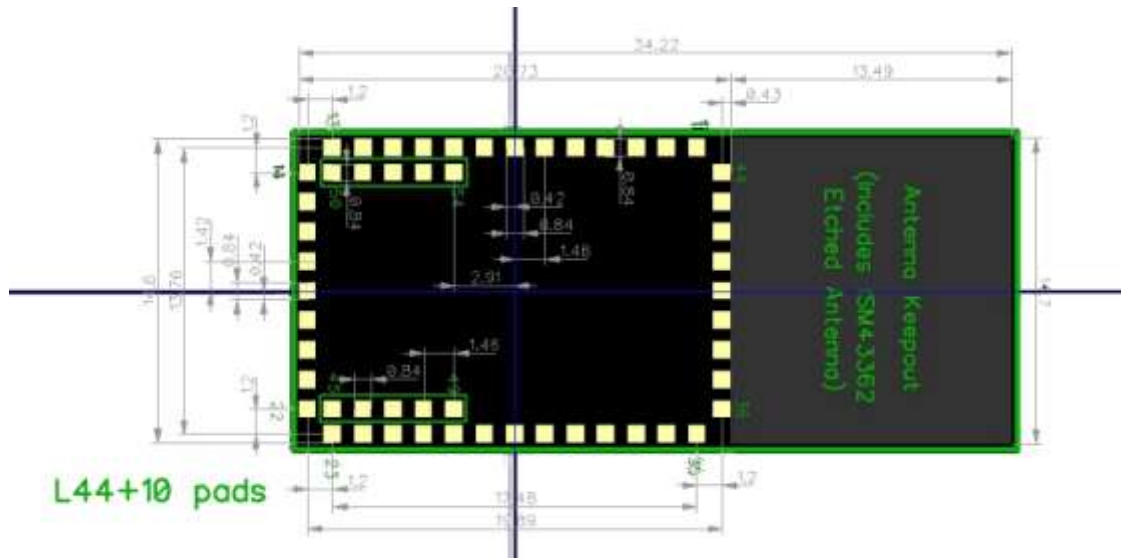

Figure 2: Chip Antenna Keep out Area

"Keep out" area should have the antenna hanging off the side of the PCB for best performance. If you do not hang the antenna off the PCB, remove ground planes and PCB material under the antenna (13.49 x 14.7 mm keep out area). Surrounding metal should be 9 mm away from cutout area, metal will affect the antenna performance. The external antenna does not require "keep out" area.



12 ISM43903-R48-L54 FOOTPRINT

12.1 ISM43903-R48-L54 eS-WiFi Module's Dimensions top view (mm)

The ISM43903-R48-L54 offers 10 extra GPIO pins (pins 45-54), see Figure 3. The eS-WiFi module is footprint compatible with our standard 44 pin LGA footprint, see Figure 4

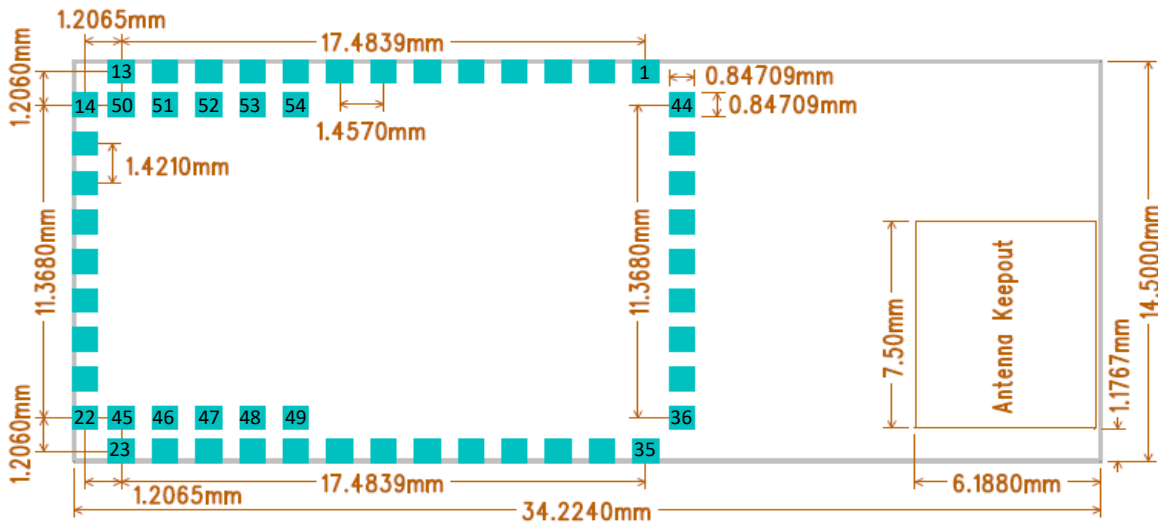

Figure 3 eS-WiFi Module Dimensions- Top View

13 PRODUCT COMPLIANCE CONSIDERATIONS

RoHS: Restriction of Hazardous Substances (RoHS) directive has come into force since 1st July 2006 all electronic products sold in the EU must be free of hazardous materials, such as lead. Inventek is fully committed to being one of the first to introduce lead-free products while maintaining backwards compatibility and focusing on a continuously high level of product and manufacturing quality.

EMI/EMC: The Inventek **eS-WiFi** module design embeds EMI/EMC suppression features and accommodations to allow for higher operational reliability in noisier (RF) environments and easier integration compliance in host (OEM) applications.

FCC/IC/CE: The **eS-WiFi** module has passed FCC/IC/CE compliance.

14 REFLOW PROFILE

- Reference the IPC/JEDEC standard.
- Peak Temperature: <math><250^{\circ}\text{C}</math>
- Number of Times: ≤ 2 times

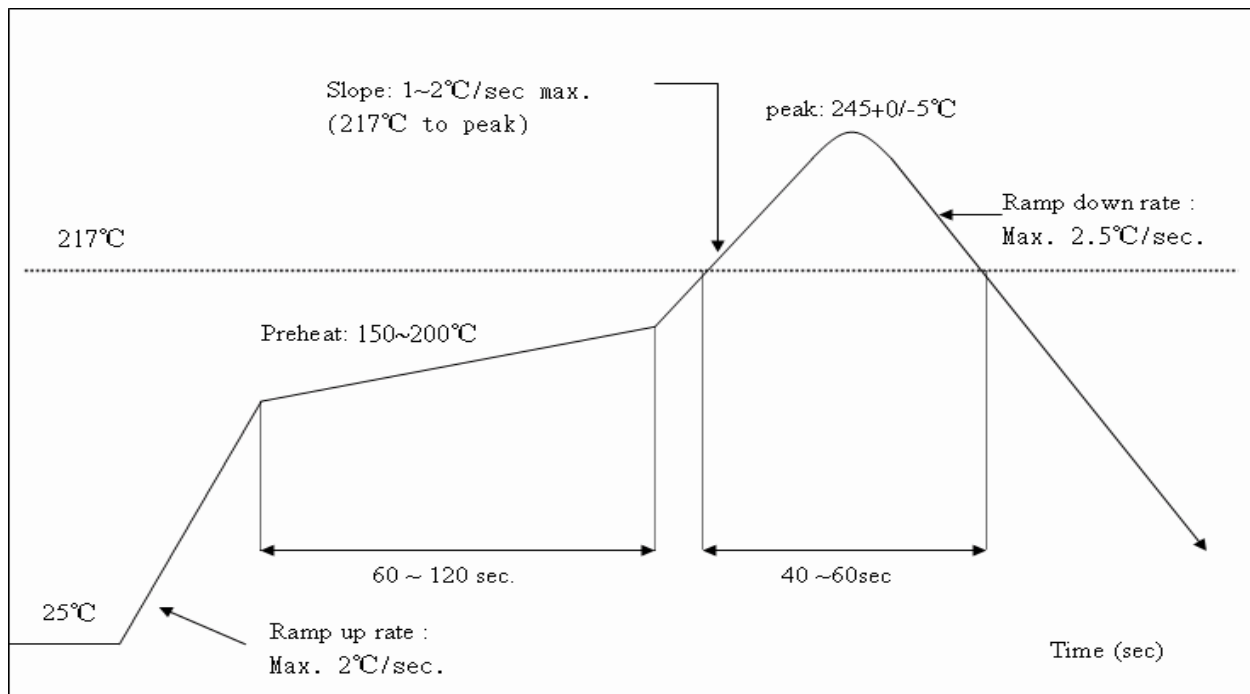

15 PACKING INFORMATION

15.1 MSL Level / Storage Condition

	<h3>Caution</h3> <p>This bag contains</p> <h3>MOISTURE-SENSITIVE DEVICES</h3> <p>Do not open except under controlled conditions</p>	<p>LEVEL</p> <div style="border: 1px solid black; padding: 5px; width: 40px; margin: 0 auto;">4</div>
	<p>1. Calculated shelf life in sealed bag: 12 months at <math>< 40^{\circ}\text{C}</math> and <math>< 90\%</math> relative humidity(RH)</p> <p>2. Peak package body temperature: 225°C 240°C 250°C 260°C</p> <p style="margin-left: 100px;"> <input type="checkbox"/> <input type="checkbox"/> <input checked="" type="checkbox"/> <input type="checkbox"/> </p> <p>3. After bag is opened, devices that will be subjected to reflow solder or other high temperature process must</p> <p style="margin-left: 20px;">a) Mounted within: 48 hours of factory conditions <math>< 30^{\circ}\text{C}/60\%</math> RH, OR</p> <p style="margin-left: 20px;">b) Stored at <math>< 10\%</math> RH</p> <p>4. Devices require bake, before mounting, if:</p> <p style="margin-left: 20px;">a) Humidity Indicator Card is >10% when read at $23 \pm 5^{\circ}\text{C}$</p> <p style="margin-left: 20px;">b) 3a or 3b not met</p> <p>5. If baking is required, devices may be baked for 24 hours at $125 \pm 5^{\circ}\text{C}$</p> <p>Note : If device containers cannot be subjected to high temperature or shorter bake times are desired, reference IPC/JEDEC J-STD-033 for bake procedure</p> <p>Bag Seal Date: See-SEAL DATE LABEL</p> <p>Note: Level and body temperature defined by IPC/JEDEC J-STD-020</p>	

15.2 Device baking requirements prior to assembly

Boards must be baked prior to rework or assembly to avoid damaging moisture sensitive components during localized reflow. The default bake cycles is 24 hours at 125C.

Maintaining proper control of moisture uptake in components is critical.

Before opening the shipping bag and attempting solder reflow, you should maintain a minimal out-of-bag time and ensure the highest possible package reliability for the final product.

16 TEMP. RATING

Symbol	Description	MIN	TYP	MAX	UNIT
TA	Temperature(ambient)	-40		85	°C

NOTE: Functionality is guaranteed, but specifications require derating at extreme temperatures.

Symbol	Thermal Characteristic	WLBGA	Unit
Θ_{JA}	Thermal resistance, junction to ambient (0 m/s)	31.72	°C/W
Θ_{JB}	Thermal resistance, junction to board	3.95	°C/W
Θ_{JC}	Thermal resistance, junction to case	2.16	°C/W
ψ_{JT}	Thermal characterization, junction to top of package	4.3	°C/W
ψ_{JB}	Thermal characterization, junction to top of package	9.28	°C/W
Tj	Maximum Junction Temperature	113.9	°C
Pmax	Maximum power dissipation	1.38	W

17 REVISION CONTROL

Document: ISM43903-R48-L54	eS-WiFi module
External Release	DOC-DS-

Date	Author	Revision	Comment
3/14/2017	KMT	1.0	Preliminary Release
4/14/17	AS	1.1	Ordering P/N, EVBs, IWIN, eS-WiFi, and Copyright
5/30/17	AS	2.3	10-15uF Bulk Cap to VBAT
5/31/17	AS	2.4	Temp. Profile

18 CONTACT INFORMATION

Inventek Systems
2 Republic Road
Billerica MA, 01862
Tel: 978-667-1962
Sales@inventeksys.com

www.inventeksys.com

Copyright 2017, Inventek Systems. All Rights Reserved. This software, associated documentation and materials ("Software"), referenced and provided with this documentation is owned by Inventek Systems and is protected by and subject to worldwide patent protection (United States and foreign), United States copyright laws and international treaty provisions. Therefore, you may use this Software only as provided in the license agreement accompanying the software package from which you obtained this Software

("EULA"). If no EULA applies, Inventek Systems hereby grants you a personal, non-exclusive, non-transferable license to copy, modify, and compile the Software source code solely for use in connection with Inventek's integrated circuit products.

Any reproduction, modification, translation, compilation, or representation of this Software except as specified above is prohibited without the express written permission of Inventek. Disclaimer: THIS SOFTWARE IS PROVIDED AS-IS, WITH NO WARRANTY OF ANY KIND, EXPRESS OR IMPLIED, INCLUDING, BUT NOT LIMITED TO, NONINFRINGEMENT, IMPLIED WARRANTIES OF MERCHANTABILITY AND FITNESS FOR A PARTICULAR PURPOSE.

Inventek reserves the right to make changes to the Software without notice. Inventek does not assume any liability arising out of the application or use of the Software or any product or circuit described in the Software. Inventek does not authorize its products for use in any products where a malfunction or failure of the Inventek product may reasonably be expected to result in significant property damage, injury, or death ("High Risk Product"). By including Inventek's product in a High Risk product, the manufacturer of such system or application assumes all risk of such use and in doing so agrees to indemnify Inventek against all liability. Inventek Systems reserves the right to make changes without further notice to any products or data herein to improve reliability, function, or design. The information contained within is believed to be accurate and reliable. However, Inventek does not assume any liability arising out of the application or use of this information, nor the application or use of any product or circuit described herein, neither does it convey any license under its patent rights nor the rights of others.