

**SINGLE-PHASE GLASS PASSIVATED  
SILICON BRIDGE RECTIFIER**

**VOLTAGE RANGE 50 to 1000 Volts CURRENT 8.0 Amperes**

**FEATURES**

- \* Low leakage
- \* Low forward voltage
- \* Mounting position: Any
- \* Surge overload rating: 200 amperes peak
- \* Ideal for printed circuit boards
- \* High forward surge current capability

**MECHANICAL DATA**

- \* UL listed the recognized component directory, file #E94233
- \* Epoxy: Device has UL flammability classification 94V-O

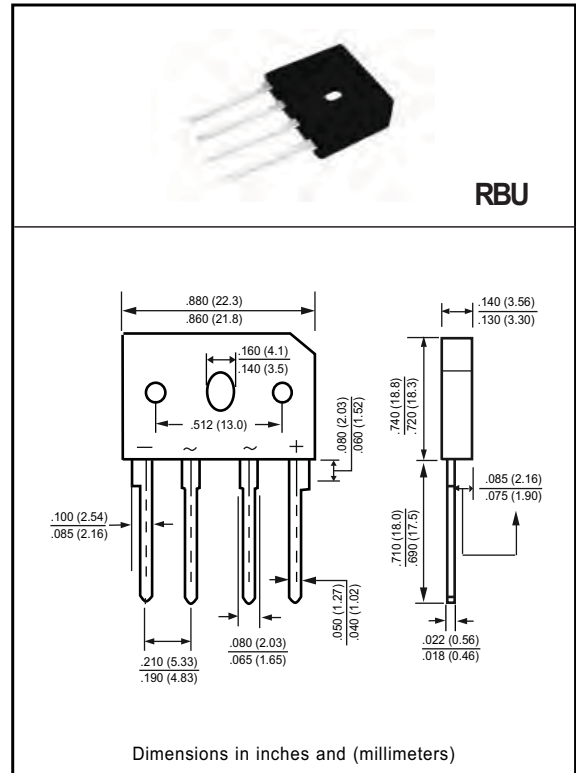

**MAXIMUM RATINGS AND ELECTRICAL CHARACTERISTICS**

Ratings at 25 °C ambient temperature unless otherwise specified.  
Single phase, half wave, 60 Hz, resistive or inductive load.  
For capacitive load, derate current by 20%.

**MAXIMUM RATINGS** (At TA = 25°C unless otherwise noted)

RATINGS	SYMBOL	RBU801M	RBU802M	RBU803M	RBU804M	RBU805M	RBU806M	RBU807M	UNITS
Maximum Recurrent Peak Reverse Voltage	VRRM	50	100	200	400	600	800	1000	Volts
Maximum RMS Bridge Input Voltage	VRMS	35	70	140	280	420	560	700	Volts
Maximum DC Blocking Voltage	VDC	50	100	200	400	600	800	1000	Volts
Maximum Average Forward Rectified Output Current at Tc = 75°C	Io	8.0							Amps
Peak Forward Surge Current 8.3 ms single half sine-wave superimposed on rated load	IFSM	200							Amps
Typical Current Squared Time	I <sup>2</sup> t	167							A <sup>2</sup> /Sec
Typical Thermal Resistance (Note 1)	R θJA	21							°C/W
	R θJC	2							
Operating and Storage Temperature Range	TJ,TSTG	-55 to + 150							°C

**ELECTRICAL CHARACTERISTICS** (At TA = 25°C unless otherwise noted)

CHARACTERISTICS	SYMBOL	RBU801M	RBU802M	RBU803M	RBU804M	RBU805M	RBU806M	RBU807M	UNITS
Maximum Forward Voltage Drop per element at 8.0A DC	VF	1.0							Volts
Maximum Reverse Current at Rated	IR	0.5							uAmps
DC Blocking Voltage per element		500							

NOTE: 1. Units mounted in free air, no heatsink on P.C.B., 0.5x0.5" (12x12mm) copper pads, 0.375" lead length.  
2. \* ROHS compliant"

# RATING AND CHARACTERISTICS CURVES ( RBU801M THRU RBU807M )

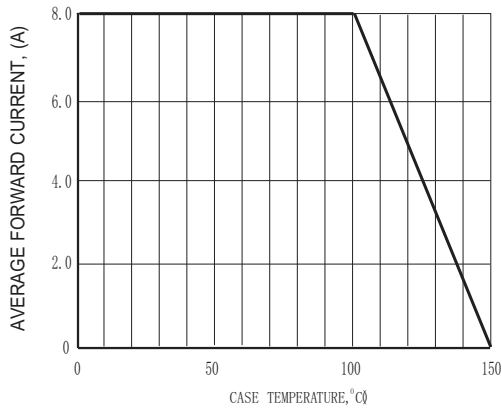

FIG. 1 TYPICAL FORWARD CURRENT DERATING CURVE

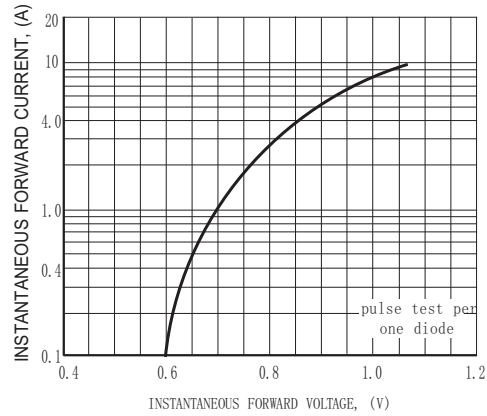

FIG. 2 TYPICAL INSTANTANEOUS FORWARD CHARACTERISTICS

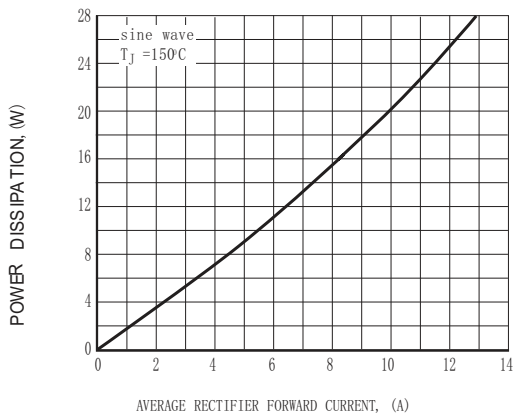

FIG. 3 FORWARD DISSIPATION

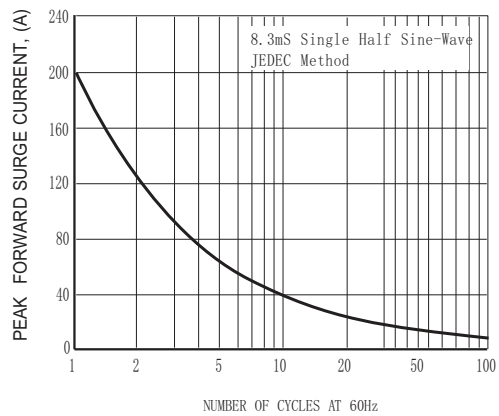

FIG. 4 MAXIMUM NON-REPETITIVE FORWARD SURGE CURRENT

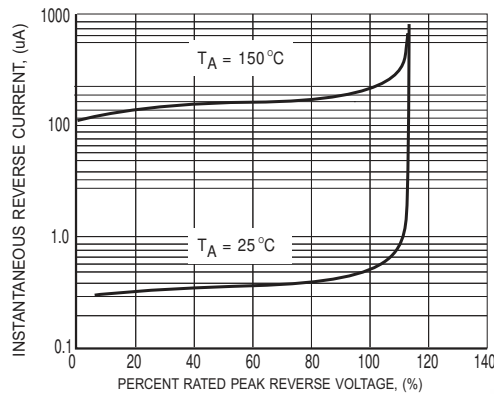

FIG. 5 MAXIMUM REVERSE CHARACTERISTICS



# RECTRON

## Attachment information about RBU80XM

### 1. Internal Circuit

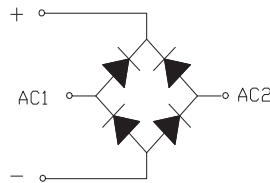

### 2. Marking on the body

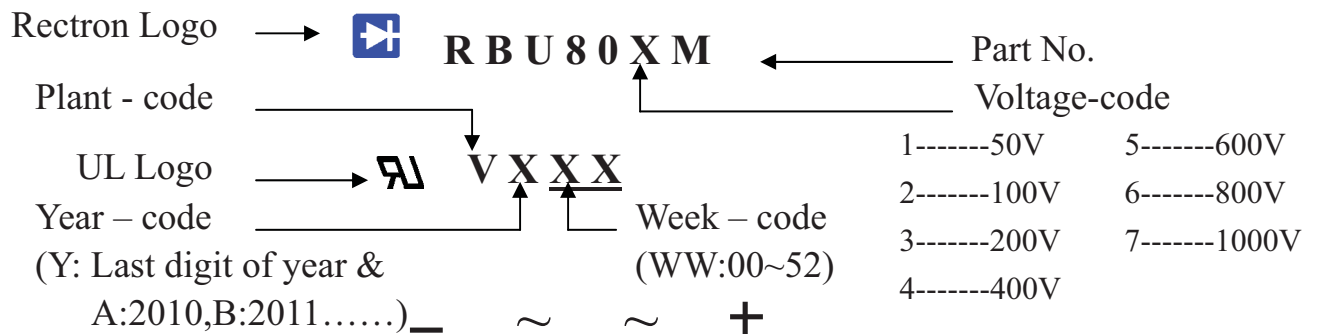

## PACKAGING OF DIODE AND BRIDGE RECTIFIERS

### TUBE PACK

PACKAGE	PACKING CODE	EA PER BOX	INNER BOX SIZE (mm)	CARTON SIZE (mm)	EA PER CARTON	WEIGHT(Kg)
RBU	-C	1,000	490*135*110	510*293*131	2,000	13.62

## 1. BOX

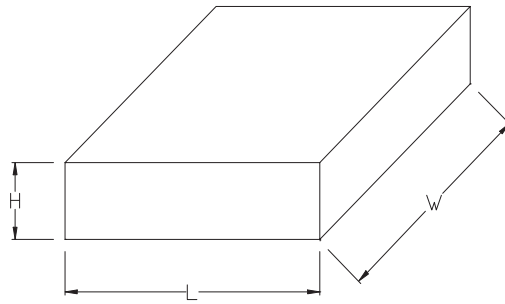

Packing Code	L (mm)	W (mm)	H (mm)
-C	490	135	110

## 2. CARTON

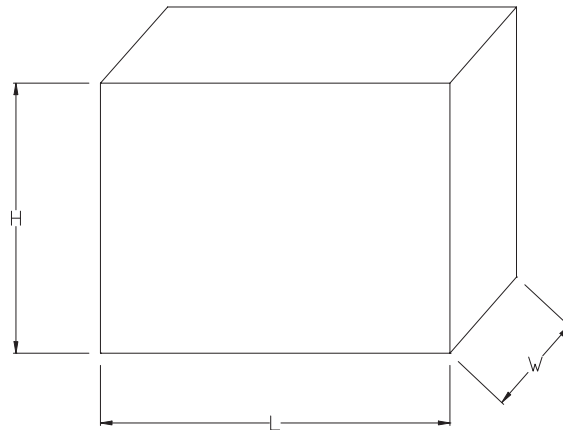

Packing Code	L (mm)	W (mm)	H (mm)
-C	510	293	131

## DISCLAIMER NOTICE

Rectron Inc reserves the right to make changes without notice to any product specification herein, to make corrections, modifications, enhancements or other changes. Rectron Inc or anyone on its behalf assumes no responsibility or liability for any errors or inaccuracies. Data sheet specifications and its information contained are intended to provide a product description only. "Typical" parameters which may be included on RECTRON data sheets and/ or specifications can and do vary in different applications and actual performance may vary over time. Rectron Inc does not assume any liability arising out of the application or use of any product or circuit.

Rectron products are not designed, intended or authorized for use in medical, life-saving implant or other applications intended for life-sustaining or other related applications where a failure or malfunction of component or circuitry may directly or indirectly cause injury or threaten a life without expressed written approval of Rectron Inc. Customers using or selling Rectron components for use in such applications do so at their own risk and shall agree to fully indemnify Rectron Inc and its subsidiaries harmless against all claims, damages and expenditures.