

RoHS  HF Lo Rho Surface Mount Series

Description

The Littelfuse Lo Rho Surface Mount PPTC (polymer positive temperature coefficient) series offers ultra low normal operating resistance while maintains the same performance of existing Littelfuse PPTC products.

Available in 5 hold current ratings, all devices are TUV and UL certified and possess a maximum fault current rating of 40A.

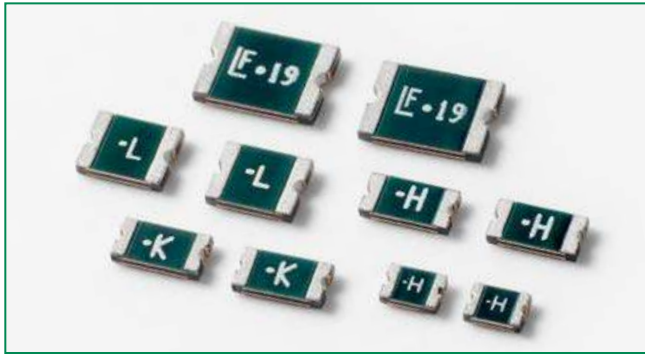

Features

- Lo Rho (low resistance at normal operating hold current)
- RoHS compliant, Lead Free and Halogen Free
- Fast response to fault currents
- Compact design saves board space
- Thin-profile <0.75mm
- Compatible with high temperature solders



Applications

- USB peripherals
- Disk drives
- CD-ROMs
- Plug and play protection for motherboards and peripherals
- PDAs / digital cameras
- Game console port protection

Agency Approvals

AGENCY	AGENCY FILE NUMBER
	E183209
	R50119118

Electrical Characteristics

Part Number	Marking	I _{hold} (A)	I _{trip} (A)	V _{max} (Vdc)	I _{max} (A)	P _d max. (W)	Maximum Time To Trip		Resistance		Agency Approvals	
							Current (A)	Time (Sec.)	R _{min} (Ω)	R _{1max} (Ω)		
0805L110SLYR	-H	1.10	1.80	6	50	0.6	8.00	0.30	0.030	0.130	X	X
1206L110SLYR	-H	1.10	2.20	6	50	0.8	8.00	0.30	0.015	0.100	X	X
1206L150SLYR	-K	1.50	3.00	6	50	0.8	8.00	0.30	0.010	0.065	X	X
1210L200SLYR	-L	2.00	4.00	6	50	0.8	8.00	3.00	0.005	0.024	X	X
1210L350SLSYR	-T	3.50	7.00	6	50	0.8	17.50	2.00	0.003	0.018	X	X
1812L190SLPR	LF 19	1.90	4.90	6	50	1.0	9.50	4.50	0.003	0.025	X	X

I_{hold} = Hold current: maximum current device will pass without tripping in 20°C still air.
 I_{trip} = Trip current: minimum current at which the device will trip in 20°C still air.
 V_{max} = Maximum voltage device can withstand without damage at rated current (I_{max})
 I_{max} = Maximum fault current device can withstand without damage at rated voltage (V_{max})
 P_d = Power dissipated from device when in the tripped state at 20°C still air.
 R_{min} = Minimum resistance of device in initial (un-soldered) state.
 R_{1max} = Maximum resistance of device at 20°C measured one hour after tripping or reflow soldering of 260°C for 20 sec.
Caution: Operation beyond the specified rating may result in damage and possible arcing and flame.

Temperature Derating

Part Number	Ambient Operation Temperature							
	-40°C	-20°C	0°C	20°C	40°C	60°C	70°C	85°C
0805L110SLYR	1.93	1.65	1.38	1.10	0.83	0.55	0.41	0.21
1206L110SLYR	2.00	1.70	1.40	1.10	0.83	0.56	0.44	0.24
1206L150SLYR	2.67	2.32	1.95	1.50	1.15	0.78	0.64	0.36
1210L200SLYR	3.26	2.87	2.50	2.00	1.70	1.29	1.09	0.78
1210L350SL-SYR	5.00	4.60	4.05	3.50	2.80	2.00	1.60	1.00
1812L190SLPR	3.00	2.58	2.22	1.90	1.49	1.14	0.93	0.61

Average Time Current Curves

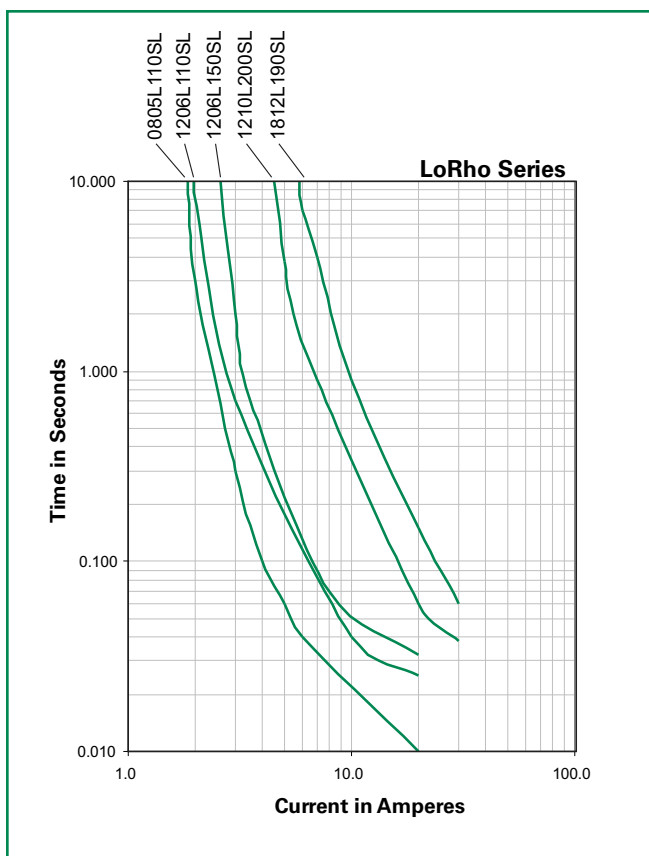

The average time current curves and Temperature Derating curve performance is affected by a number of variables, and these curves provided as guidance only. Customer must verify the performance in their application.

Temperature Derating Curve

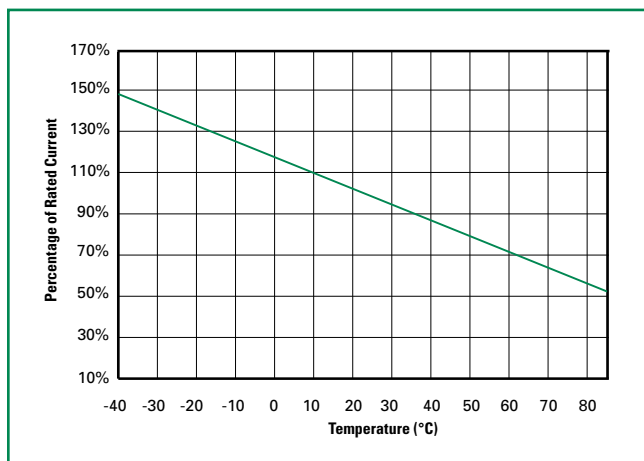

Environmental Specifications

Operating/Storage Temperature	-40°C to +85°C
Maximum Device Surface Temperature in Tripped State	125°C
Passive Aging	+85°C, 1000 hours -/+10% typical resistance change
Humidity Aging	+85°C, 85% R.H., 100 hours -/+15% typical resistance change
Thermal Shock	MIL-STD-202, Method 107G +85°C/-40°C 20 times -30% typical resistance change
Solvent Resistance	MIL-STD-202, Method 215 No change
Vibration	MIL-STD-883C, Method 2007.1, Condition A No change
Moisture Sensitivity Level	Level 1, J-STD-020C

Physical Specifications

Terminal Material	Solder-Plated Copper (Solder Material: Matte Tin (Sn))
Lead Solderability	Meets EIA Specification RS186-9E, ANSI/J-STD-002, Category 3.

Soldering Parameters

Profile Feature	Pb-Free Assembly	
Average Ramp-Up Rate ($T_{s(max)}$ to T_p)	3°C/second max	
Pre Heat:	Temperature Min ($T_{s(min)}$)	150°C
	Temperature Max ($T_{s(max)}$)	200°C
	Time (Min to Max) (t_s)	60 – 180 secs
Time Maintained Above:	Temperature (T_L)	217°C
	Temperature (t_L)	60 – 150 seconds
Peak / Classification Temperature (T_p)	260 ^{+0/-5} °C	
Time within 5°C of actual peak Temperature (t_p)	20 – 40 seconds	
Ramp-down Rate	6°C/second max	
Time 25°C to peak Temperature (T_p)	8 minutes Max.	

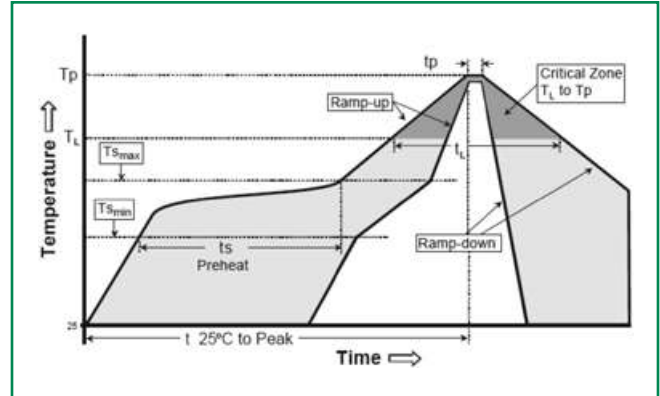

- All temperature refer to topside of the package, measured on the package body surface
- If reflow temperature exceeds the recommended profile, devices may not meet the performance requirements
- Recommended reflow methods: IR, vapor phase oven, hot air oven, N₂ environment for lead
- Recommended maximum paste thickness is 0.25mm (0.010 inch)
- Devices can be cleaned using standard industry methods and solvents
- Devices can be reworked using the standard industry practices

Dimensions

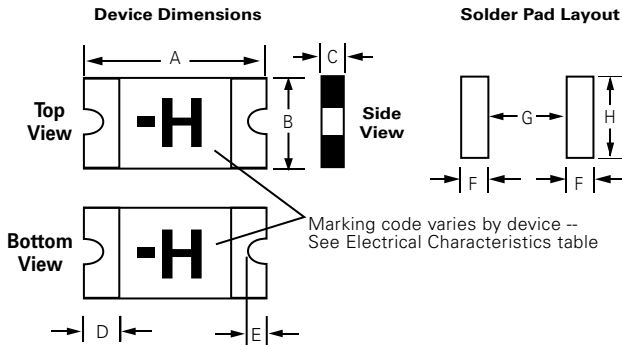

Part Number	Device Dimension										Solder Pad Layout		
	A		B		C		D		E		F	G	H
	mm	mm	mm	mm	mm	mm	mm	mm	mm	mm			
0805L110SLYR	2.00	2.20	1.20	1.50	0.40	0.75	0.20	0.55	0.10	0.45	1.00	1.20	1.50
1206L110SLYR	3.00	3.40	1.50	1.80	0.40	0.75	0.25	0.75	0.10	0.45	1.00	1.80	1.80
1206L150SLYR	3.00	3.40	1.50	1.80	0.40	0.70	0.25	0.75	0.10	0.45	1.00	1.80	1.80
1210L200SLYR	3.00	3.43	2.35	2.80	0.40	0.70	0.25	0.75	0.20	0.50	1.00	2.00	2.50
1210L350SL-SYR	3.00	3.43	2.35	2.80	0.60	1.00	0.25	0.75	0.20	0.50	1.00	2.00	2.50
1812L190SLPR	4.37	4.73	3.07	3.41	0.40	0.70	0.30	1.20	0.25	0.65	1.78	3.45	3.15

Part Ordering Number System

0805 L 110 SL Y R

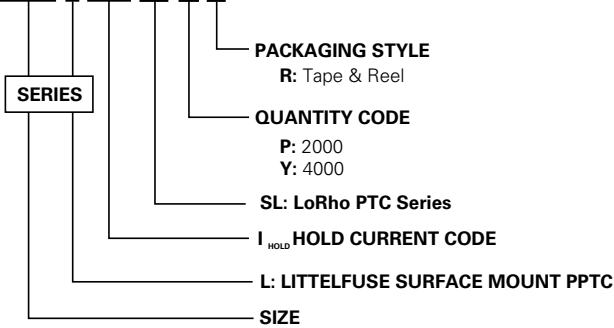

Packaging

Part Number	I _{hold} (A)	I _{hold} Code	Packaging Option	Quantity	Quantity & Packaging Codes
0805L110SLYR	1.10	110	Tape & Reel	4000	YR
1206L110SLYR	1.10	110		4000	YR
1206L150SLYR	1.50	150		4000	YR
1210L200SLYR	2.00	200		4000	YR
1210L350SLSYR	3.50	350		4000	YR
1812L190SLPR	1.90	190		2000	PR

Tape and Reel Specifications

TAPE SPECIFICATIONS: EIA-481-1 (mm)

	0805L110SL	1206L110SL 1206L150SL	1210L200SL 1210L350SL-S	1812P190SL
W	8.0+/-0.10	8.15+0.15-0.30	8.0+/-0.30	12.00+0.30-0.10
F	3.5+/-0.05	3.50+/-0.05	3.5+/-0.05	5.50+/-0.05
E₁	1.75+/-0.10	1.75+/-0.10	1.75+/-0.10	1.75+/-0.10
D₀	1.55+/-0.05	1.55+/-0.05	1.55+/-0.05	1.50+0.10
D₁	1.0 (min)	1.00 (MIN)	1.0 (min)	1.50+0.25
P₀	4.0+/-0.10	4.00+/-0.10	4.0+/-0.10	4.00+/-0.10
P₁	4.0+/-0.10	4.00+/-0.10	4.0+/-0.10	8.00+/-0.10
P₂	2.0+/-0.05	2.00+/-0.05	2.0+/-0.05	2.00+/-0.05
A₀	1.45+/-0.10	1.95+/-0.10	2.82+/-0.10	3.58+/-0.10
B₀	2.30+/-0.10	3.65+/-0.10	3.46+/-0.10	4.93+/-0.10
T	0.25+/-0.10	0.25+/-0.10	0.25+/-0.10	0.25+/-0.10
K₀	0.74+/-0.10	0.87+/-0.10	1.00+/-0.10	1.02+/-0.10
Leader min.	390	390	390	390
Trailer min.	160	160	160	160

REEL DIMENSIONS: EIA-481-1 (mm)

	0805L110SL 1210L200SL	1206L110SL 1206L150SL 1812P190SL
H	12.0+/-0.05	16.0+/-0.2
W	9.0+/-0.5	13.2+/-1.5
D	Ø60+0.5	Ø 60.2+/-0.5
F	Ø13.0+/-0.2	Ø 13.0+/-0.5
C	Ø178+/-1.0	Ø 178+/-1.0
H₁	11+/-0.5	11+/-0.5
W₁	2.2+/-0.5	2.5+0.5
W₂	3.0+0.5	3.0+0.5
W₃	4.0+0.5	4.0+0.5
W₄	5.5+0.5	5.0+0.5

Tape and Reel Diagram

