

SCHOTTKY BARRIER RECTIFIER**APD160****Features**

- Low Forward Voltage Drop
- Very Small Conduction Losses
- High Surge Capability
- Surge Overload Rating to 35A Peak

Applications

- Low Voltage High Frequency Inverters
- DC-DC Converters
- Free Wheeling
- Polarity Protection

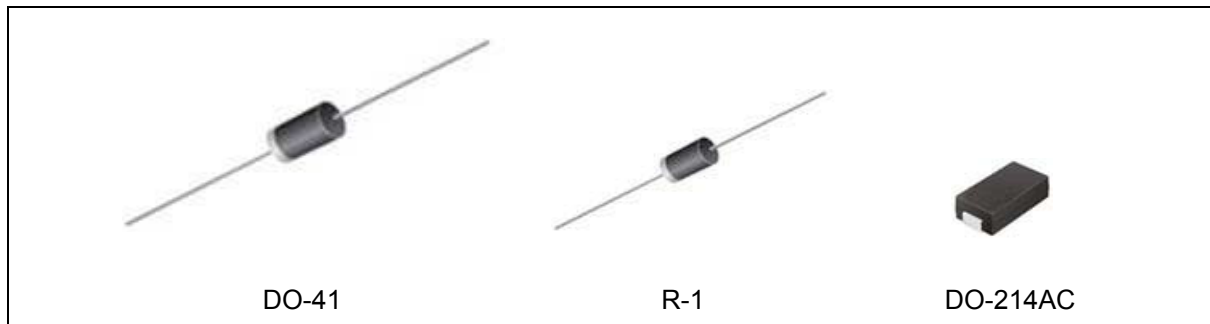

Figure 1. Package Types of APD160

Pin Configuration

Figure 2. Pin Configuration of APD160 (Top View)

SCHOTTKY BARRIER RECTIFIER

APD160

Ordering Information

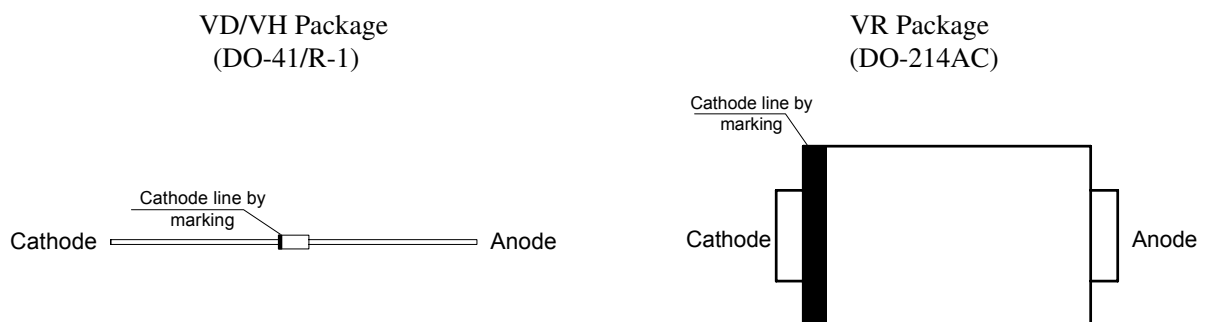
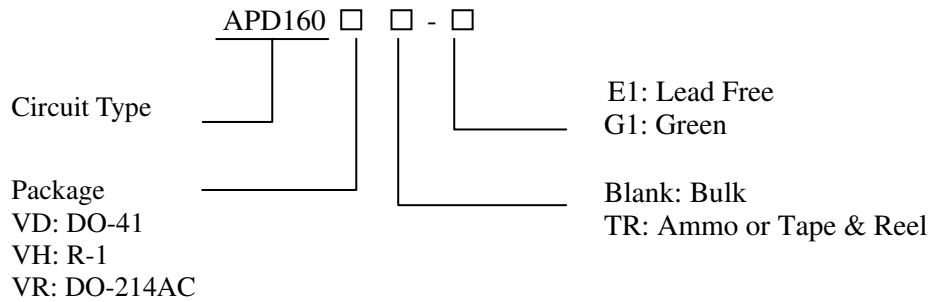

Package	Temperature Range	Part Number		Marking ID		Packing Type
		Lead Free	Green	Lead Free	Green	
DO-41	-65 to 125°C	APD160VD-E1	APD160VD-G1	D160VD	160VDG	Bulk
		APD160VDTR-E1	APD160VDTR-G1	D160VD	160VDG	Ammo
R-1	-65 to 125°C	APD160VH-E1	APD160VH-G1	D160VH	160VHG	Bulk
		APD160VHTR-E1	APD160VHTR-G1	D160VH	160VHG	Ammo
DO-214AC	-65 to 125°C		APD160VRTR-G1		160VRG	Tape & Reel

BCD Semiconductor's Pb-free products, as designated with "E1" suffix in the part number, are RoHS compliant. Products with "G1" suffix are available in green packages.

**SCHOTTKY BARRIER RECTIFIER****APD160****Absolute Maximum Ratings** ($T_A=25^\circ\text{C}$ unless otherwise noted) (Note 1)

Parameter	Symbol	Value	Unit
Maximum Repetitive Peak Reverse Voltage	V_{RRM}	60	V
Maximum DC Blocking Voltage	V_{DC}	60	V
Maximum RMS Voltage	V_{RMS}	42	V
Average Rectified Forward Current 0.375" (9.5mm) Lead Length	$I_{F(AV)}$	1.0	A
Non-repetitive Peak Forward Surge Current 8.3ms Single Half Sine-wave on Rated Load	I_{FSM}	35	A
Operating Junction Temperature Range	T_J	-65 to 125	$^\circ\text{C}$
Storage Temperature Range	T_{STG}	-65 to 150	$^\circ\text{C}$

Note 1: Stresses greater than those listed under "Absolute Maximum Ratings" may cause permanent damage to the device. These are stress ratings only, and functional operation of the device at these or any other conditions beyond those indicated under "Recommended Operating Conditions" is not implied. Exposure to "Absolute Maximum Ratings" for extended periods may affect device reliability.

Thermal Characteristics ($T_A=25^\circ\text{C}$ unless otherwise noted)

Parameter	Symbol	Value	Unit
Typical Thermal Resistance	θ_{JA}	DO-41	80
		R-1	80
		DO-214AC	100
			$^\circ\text{C/W}$

Electrical Characteristics ($T_A=25^\circ\text{C}$ unless otherwise noted)

Parameter	Symbol	Min	Typ	Max	Unit
Forward Voltage @ $I_F=1.0\text{A}$	V_F		0.68		V
Reverse Current @ Rated V_R (Note 2)	I_R	$T_A=25^\circ\text{C}$		0.5	mA
		$T_A=100^\circ\text{C}$		10	

Note 2: Pulse Test: 300 μs pulse width, 1.0% duty cycle.

SCHOTTKY BARRIER RECTIFIER

APD160

Typical Performance Characteristics

($T_A=25^{\circ}\text{C}$ unless otherwise noted)

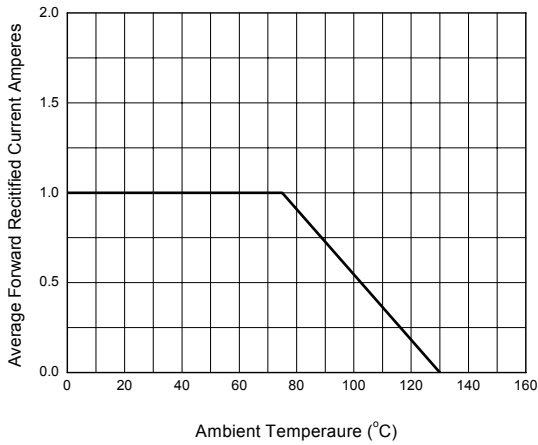

Figure 3. Forward Current Derating Curve

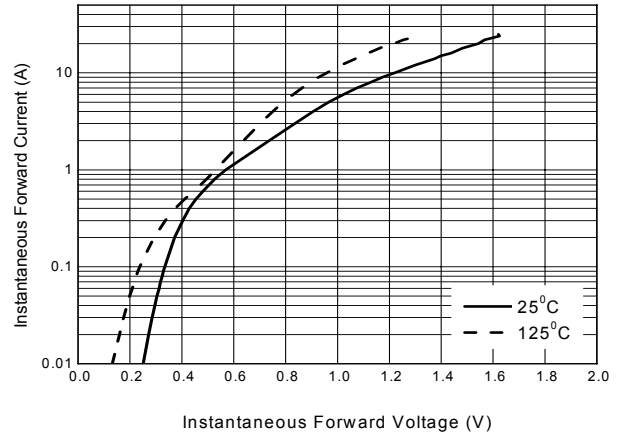

Figure 4. Typical Instantaneous Forward Characteristics

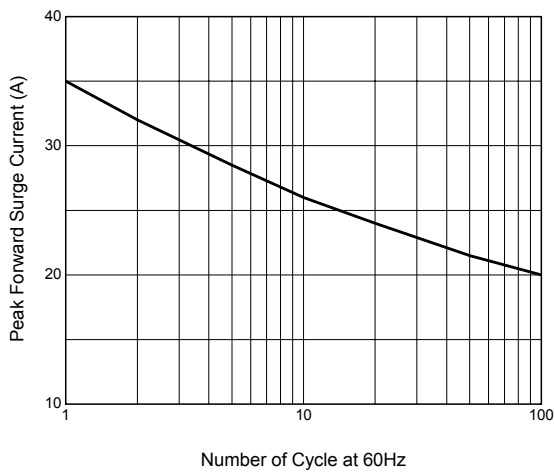

Figure 5. Maximum Non-Repetitive Surge Current

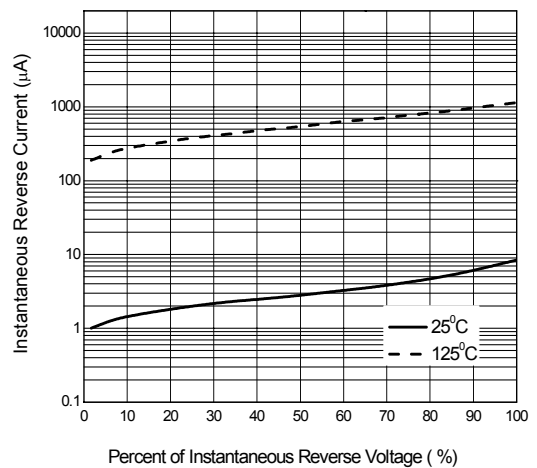

Figure 6. Typical Reverse Characteristics

Typical Performance Characteristics (Continued)

Figure 7. Typical Junction Capacitance

SCHOTTKY BARRIER RECTIFIER

APD160

Mechanical Dimensions

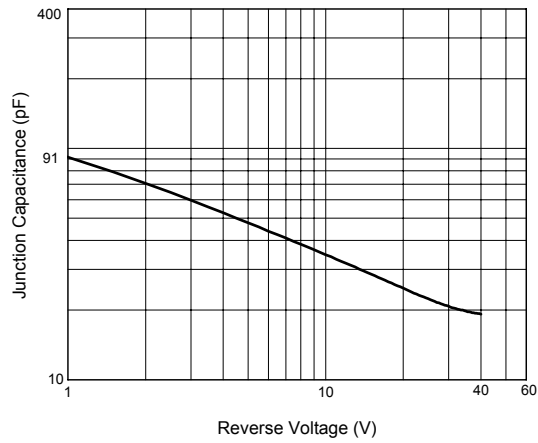
DO-41

Unit: mm(inch)

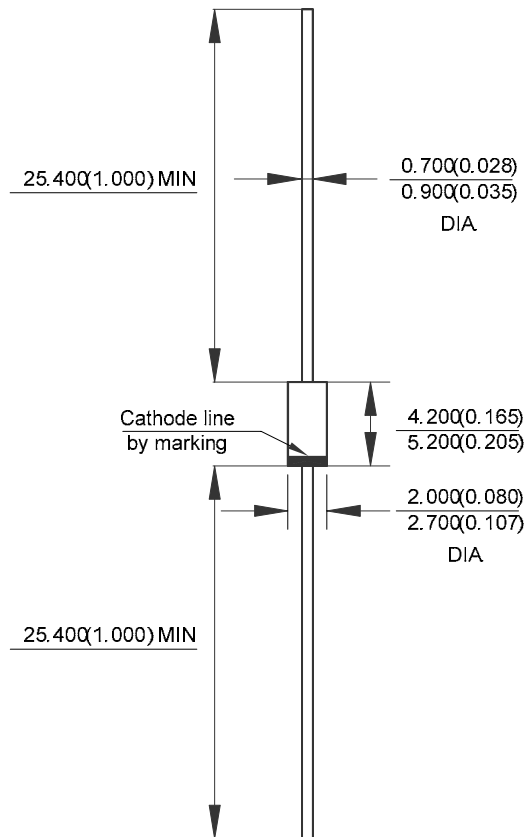

SCHOTTKY BARRIER RECTIFIER

APD160

Mechanical Dimensions (Continued)

R-1

Unit: mm(inch)

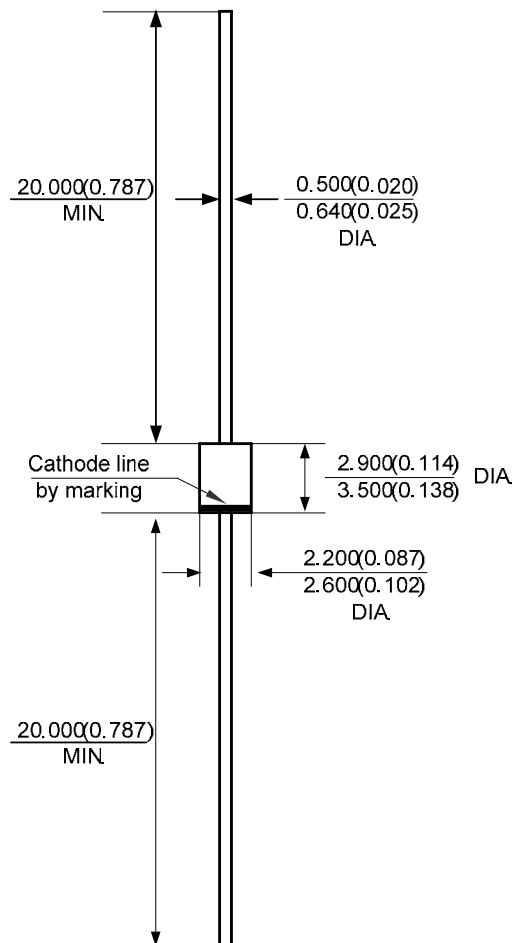

SCHOTTKY BARRIER RECTIFIER

APD160

Mechanical Dimensions (Continued)

DO-214AC

Unit: mm(inch)

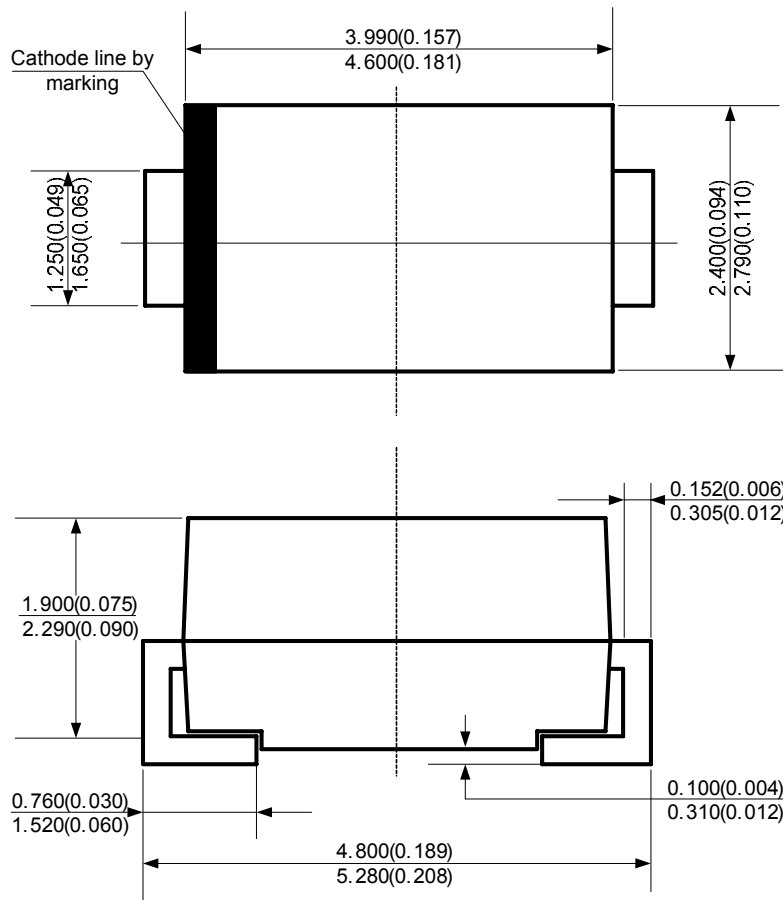



BCD Semiconductor Manufacturing Limited

<http://www.bcdsemi.com>

IMPORTANT NOTICE

BCD Semiconductor Manufacturing Limited reserves the right to make changes without further notice to any products or specifications herein. BCD Semiconductor Manufacturing Limited does not assume any responsibility for use of any its products for any particular purpose, nor does BCD Semiconductor Manufacturing Limited assume any liability arising out of the application or use of any its products or circuits. BCD Semiconductor Manufacturing Limited does not convey any license under its patent rights or other rights nor the rights of others.

MAIN SITE

- Headquarters

BCD Semiconductor Manufacturing Limited

No. 1600, Zi Xing Road, Shanghai ZiZhu Science-based Industrial Park, 200241, China
Tel: +86-21-24162266, Fax: +86-21-24162277

- Wafer Fab

Shanghai SIM-BCD Semiconductor Manufacturing Co., Ltd.

800 Yi Shan Road, Shanghai 200233, China
Tel: +86-21-6485 1491, Fax: +86-21-5450 0008

REGIONAL SALES OFFICE

Shenzhen Office

Shanghai SIM-BCD Semiconductor Manufacturing Co., Ltd., Shenzhen Office

Unit A Room 1203, Skyworth Bldg., Gaoxin Ave. 1.S., Nanshan District, Shenzhen, China
Tel: +86-755-8826 7951
Fax: +86-755-8826 7865

Taiwan Office

BCD Semiconductor (Taiwan) Company Limited

4F, 298-1, Rui Guang Road, Nei-Hu District, Taipei, Taiwan
Tel: +886-2-2656 2808
Fax: +886-2-2656 2806

USA Office

BCD Semiconductor Corp.

30920 Huntwood Ave. Hayward, CA 94544, USA
Tel : +1-510-324-2988
Fax: +1-510-324-2788