

1A, 20V - 150V Schottky Barrier Surface Mount Rectifier

FEATURES

- Ideal for automated placement
- Compact package size, profile <0.85mm
- High surge current capability
- Low power loss, high efficiency
- Moisture sensitivity level: level 1, per J-STD-020
- RoHS Compliant
- Halogen-free according to IEC 61249-2-21

APPLICATIONS

- Switching mode power supply (SMPS)
- Adapters
- DC to DC converter

MECHANICAL DATA

- Case: SOD-123HE
- Molding compound meets UL 94V-0 flammability rating
- Terminal: Matte tin plated leads, solderable per J-STD-002
- Meet JESD 201 class 2 whisker test
- Polarity: Indicated by cathode band
- Weight: 0.021g (approximately)

KEY PARAMETERS		
PARAMETER	VALUE	UNIT
I_F	1	A
V_{RRM}	20 - 150	V
I_{FSM}	30	A
T_{JMAX}	125, 150	°C
Package	SOD-123HE	
Configuration	Single die	

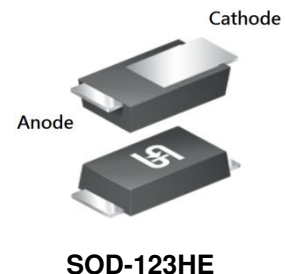

ABSOLUTE MAXIMUM RATINGS ($T_A = 25^\circ\text{C}$ unless otherwise noted)								
PARAMETER	SYMBOL	SS12 LS	SS13 LS	SS14 LS	SS16 LS	SS110 LS	SS115 LS	UNIT
Marking code on the device		12LS	13LS	14LS	16LS	10LS	A5LS	
Repetitive peak reverse voltage	V_{RRM}	20	30	40	60	100	150	V
Reverse voltage, total rms value	$V_{R(RMS)}$	14	21	28	42	70	105	V
Forward current	I_F	1						A
Peak forward surge current, 8.3ms single half sine-wave superimposed on rated load	I_{FSM}	30						A
Junction temperature	T_J	- 55 to +125		- 55 to +150			°C	
Storage temperature	T_{STG}	- 55 to +150						°C

THERMAL PERFORMANCE			
PARAMETER	SYMBOL	TYP	UNIT
Junction-to-case thermal resistance	$R_{\theta JC}$	25	°C/W
Junction-to-ambient thermal resistance	$R_{\theta JA}$	70	°C/W

ELECTRICAL SPECIFICATIONS ($T_A = 25^\circ\text{C}$ unless otherwise noted)									
PARAMETER		CONDITIONS	SYMBOL	TYP	MAX	UNIT			
Forward voltage ⁽¹⁾	SS12LS	$I_F = 0.5\text{A}, T_J = 25^\circ\text{C}$	V_F	-	-	V			
	SS13LS			-	-	V			
	SS14LS			-	0.51	V			
	SS16LS			-	0.58	V			
	SS110LS			-	0.70	V			
	SS115LS			-	0.75	V			
	SS12LS	$I_F = 1.0\text{A}, T_J = 25^\circ\text{C}$		-	0.45	V			
	SS13LS			-	0.50	V			
	SS14LS			-	0.55	V			
	SS16LS			-	0.70	V			
	SS110LS			-	0.80	V			
	SS115LS			-	0.90	V			
Reverse current @ rated V_R ⁽²⁾	SS12LS SS13LS SS14LS SS16LS	$T_J = 25^\circ\text{C}$	I_R	-	400	μA			
	SS110LS SS115LS			-	50	μA			
	SS12LS SS13LS SS14LS SS16LS	$T_J = 125^\circ\text{C}$		-	-	mA			
	SS110LS SS115LS			-	0.5	mA			
	Junction capacitance			SS12LS	1MHz, $V_R = 4.0\text{V}$	C_J	80	-	pF
				SS13LS			73	-	pF
		SS14LS		62			-	pF	
		SS16LS		48			-	pF	
SS110LS		28	-	pF					
SS115LS		22	-	pF					

Notes:

1. Pulse test with $PW = 0.3\text{ms}$
2. Pulse test with $PW = 30\text{ms}$

ORDERING INFORMATION		
ORDERING CODE⁽¹⁾	PACKAGE	PACKING
SS1xLS	SOD-123HE	10,000 / Tape & Reel

Notes:

1. "x" defines voltage from 20V(SS12LS) to 150V(SS115LS)

CHARACTERISTICS CURVES

($T_A = 25^\circ\text{C}$ unless otherwise noted)

Fig.1 Forward Current Derating Curve

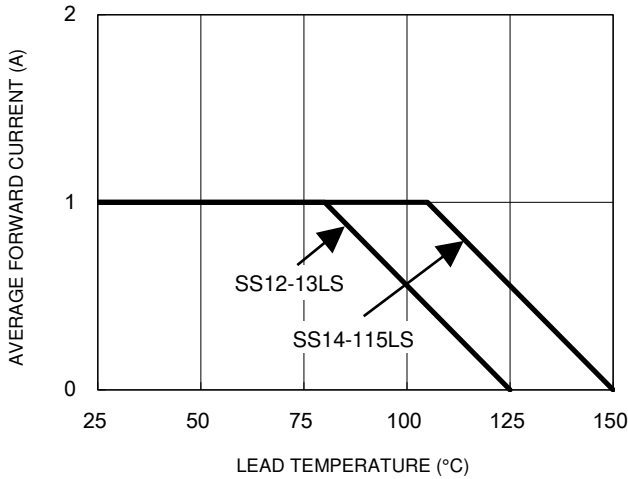

Fig.2 Typical Junction Capacitance

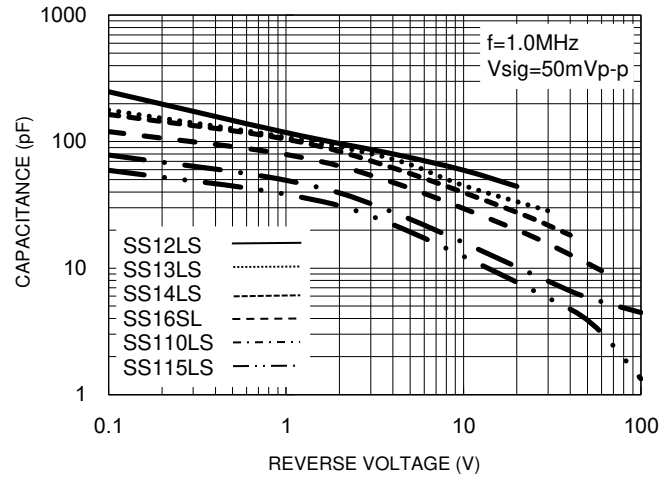

Fig.3 Typical Reverse Characteristics

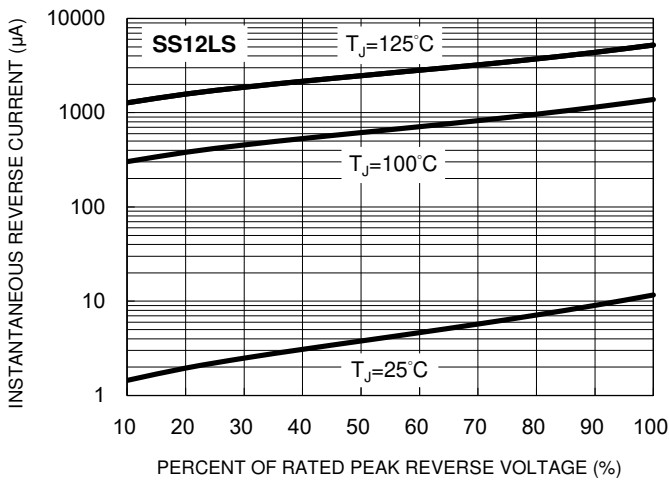

Fig.4 Typical Forward Characteristics

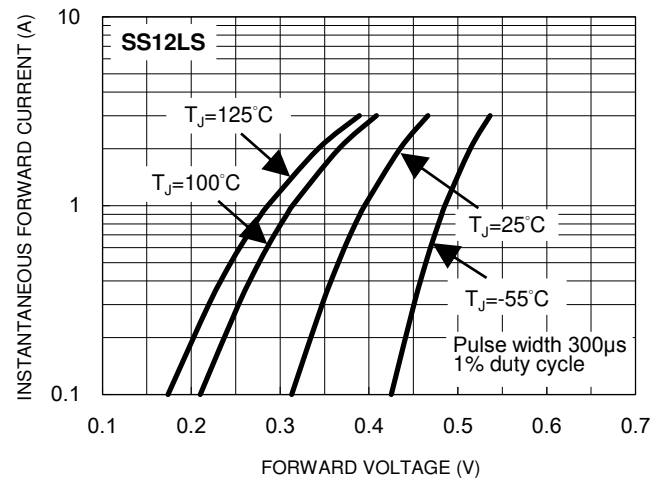

Fig.5 Typical Reverse Characteristics

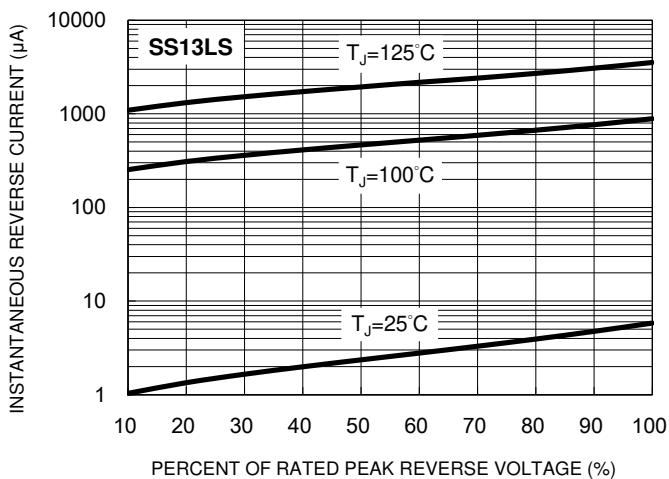
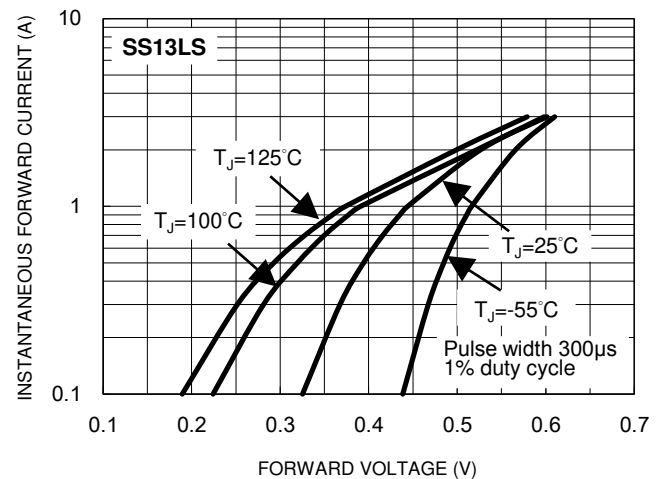

Fig.6 Typical Forward Characteristics



CHARACTERISTICS CURVES

($T_A = 25^\circ\text{C}$ unless otherwise noted)

Fig.7 Typical Reverse Characteristics

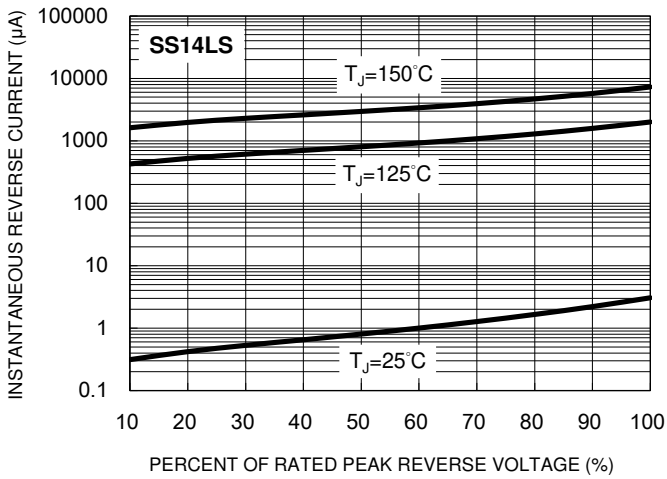

Fig.8 Typical Forward Characteristics

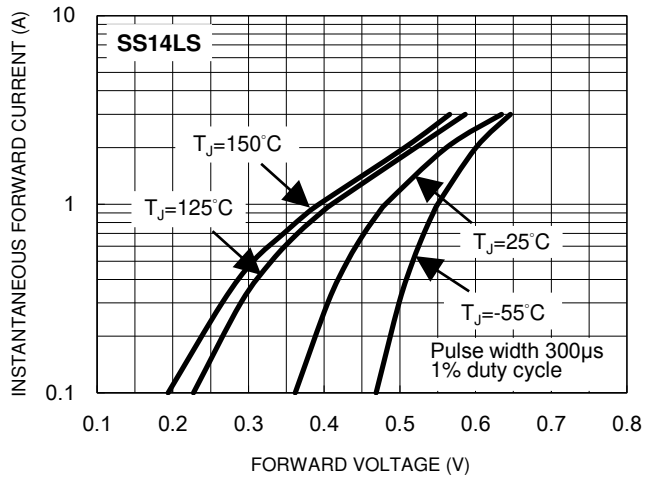

Fig.9 Typical Reverse Characteristics

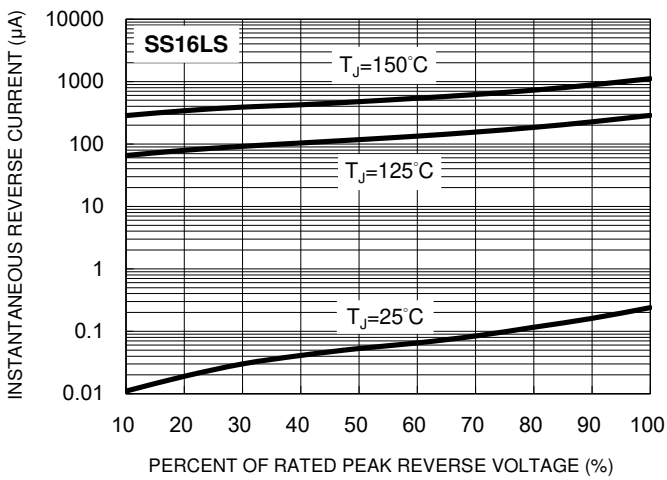

Fig.10 Typical Forward Characteristics

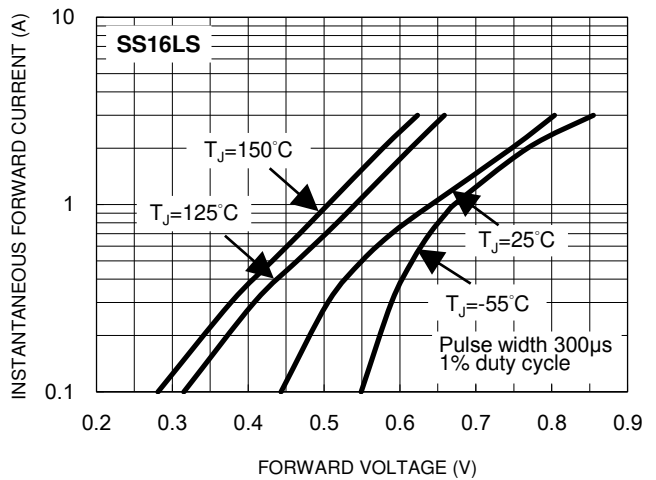

Fig.11 Typical Reverse Characteristics

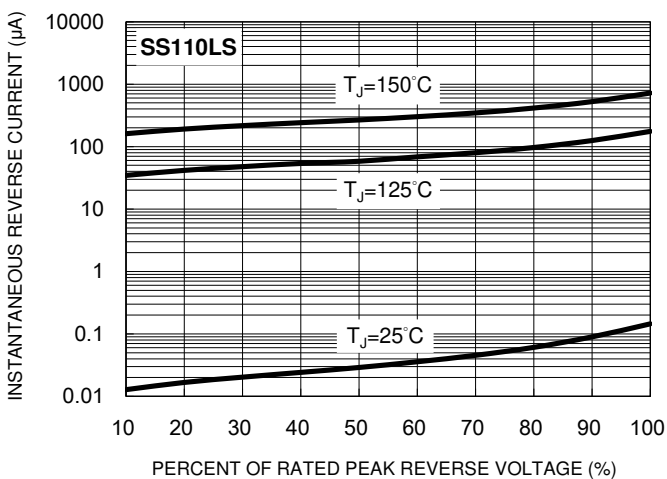
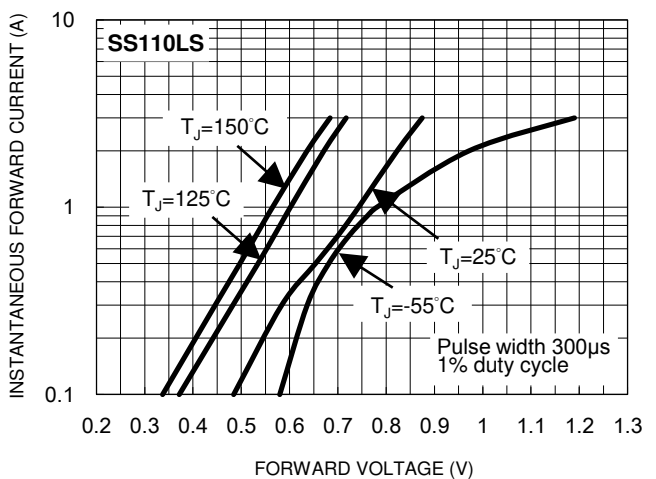

Fig.12 Typical Forward Characteristics



CHARACTERISTICS CURVES

($T_A = 25^\circ\text{C}$ unless otherwise noted)

Fig.13 Typical Reverse Characteristics

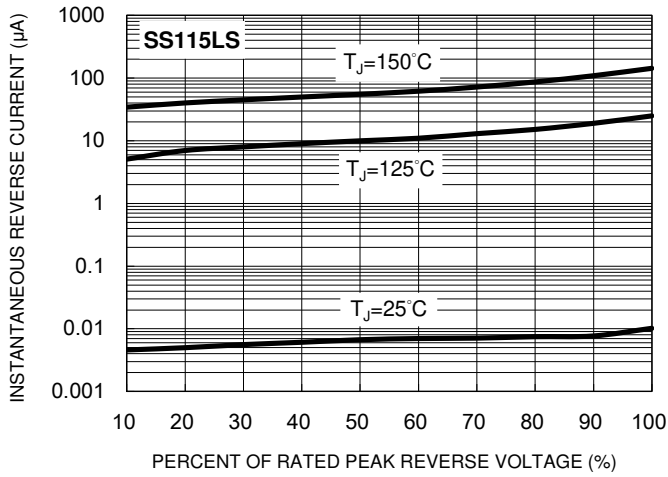

Fig.14 Typical Forward Characteristics

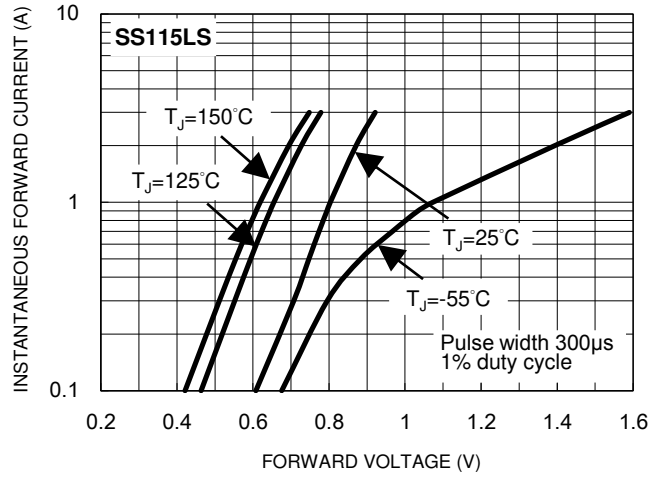
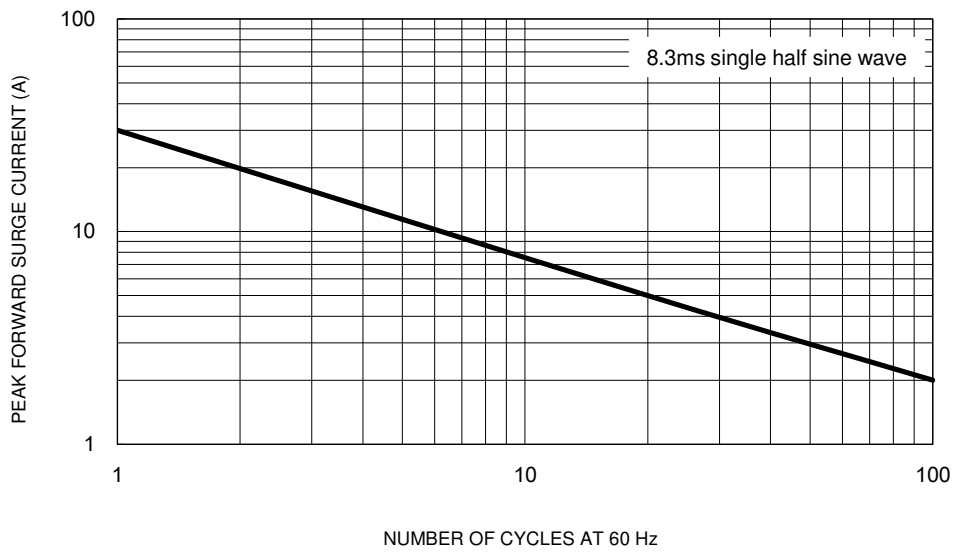
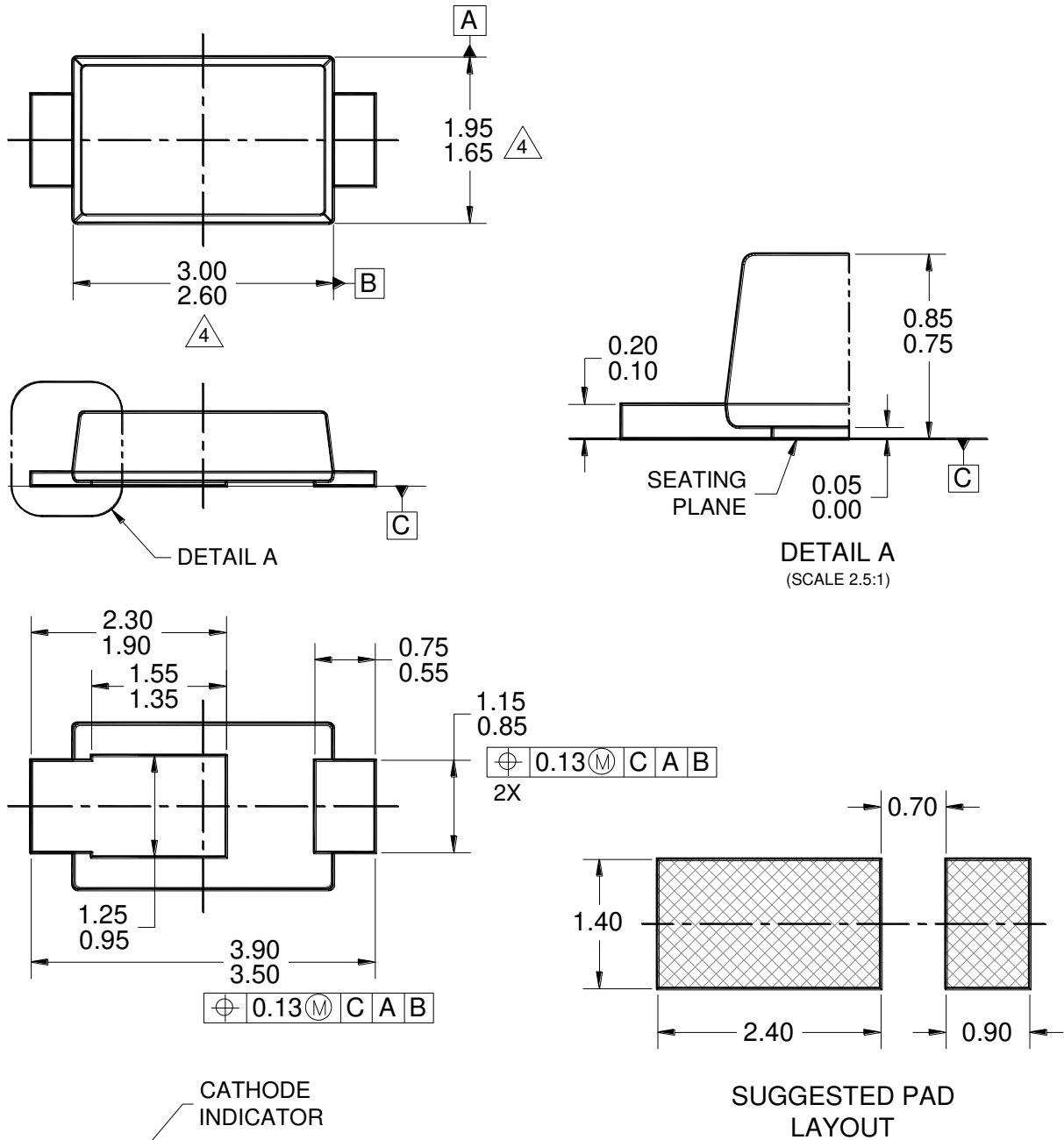

Fig.15 Maximum Non-Repetitive Forward Surge Current



PACKAGE OUTLINE DIMENSIONS

SOD-123HE



MARKING DIAGRAM

P/N = MARKING CODE
YWF = DATE CODE
F = FACTORY CODE

NOTES: UNLESS OTHERWISE SPECIFIED

1. ALL DIMENSIONS ARE IN MILLIMETERS.
2. DIMENSIONING AND TOLERANCING PER ASME Y14.5M-2009.
3. THERE IS NO EXISTING INDUSTRY STANDARD FOR THIS PACKAGE.
4. MOLDED PLASTIC BODY DIMENSIONS DO NOT INCLUDE MOLD FLASH.
5. DWG NO. REF: HQ2SD07-SOD123HE-038 REV A.

Notice

Specifications of the products displayed herein are subject to change without notice. TSC or anyone on its behalf assumes no responsibility or liability for any errors or inaccuracies.

Purchasers are solely responsible for the choice, selection, and use of TSC products and TSC assumes no liability for application assistance or the design of Purchasers' products.

Information contained herein is intended to provide a product description only. No license, express or implied, to any intellectual property rights is granted by this document. Except as provided in TSC's terms and conditions of sale for such products, TSC assumes no liability whatsoever, and disclaims any express or implied warranty, relating to sale and/or use of TSC products including liability or warranties relating to fitness for a particular purpose, merchantability, or infringement of any patent, copyright, or other intellectual property right.

The products shown herein are not designed for use in medical, life-saving, or life-sustaining applications. Customers using or selling these products for use in such applications do so at their own risk and agree to fully indemnify TSC for any damages resulting from such improper use or sale.