





SPECIFICATIONS

CUSTOMER : _____
MODEL NO. : **GFC1602M-BNFEJW15**
VERSION : **A**
DATE : **2022.09.30**
CERTIFICATION : **ROHS**

| Customer Sign | Approved By | Prepared By | Prepared By |
|---------------|---|--|---|
| |  |  |  |

晶發科技股份有限公司
GI FAR TECHNOLOGY CO.,LTD.

新北市樹林區東豐街 81 號

No. 81, Dongfeng St, Shulin District, 238034, New Taipei City, Taiwan, R.O.C.

TEL: +886-2-8684-1188 FAX: +886-2-8684-8532



Revision Record

| Data(y/m/d) | Ver. | Description | page |
|-------------|------|------------------------|------|
| 2022.09.30 | A | Specification released | |
| | | | |
| | | | |
| | | | |
| | | | |
| | | | |
| | | | |
| | | | |
| | | | |
| | | | |
| | | | |
| | | | |
| | | | |
| | | | |
| | | | |
| | | | |
| | | | |
| | | | |
| | | | |
| | | | |
| | | | |
| | | | |
| | | | |
| | | | |



CONTENTS

| | | |
|--|-------|----|
| 1. Scope | ----- | 4 |
| 2. Product Specifications | ----- | 4 |
| 2.1 General | ----- | 4 |
| 2.2 Mechanical Characteristics | ----- | 4 |
| 2.3 Absolute Maximum Ratings | ----- | 5 |
| 2.4 Electrical Characteristics | ----- | 5 |
| 2.5 Optical Characteristics Absolute maximum ratings | ----- | 5 |
| 2.6 Optical Characteristics | ----- | 6 |
| 2.7 LED Back-light Characteristics | ----- | 7 |
| 3. Reliability | ----- | 8 |
| 4. Operating Instructions | ----- | 9 |
| 4.1 Input signal Function | ----- | 9 |
| 4.2 Voltage Generator Circuit | ----- | 9 |
| 4.3 Timing Diagram | ----- | 10 |
| 4.4. Display Command | ----- | 11 |
| 5 Character Pattern | ----- | 12 |
| 6 Notes | ----- | 13 |
| 7 Operation Precautions | ----- | 13 |
| 8 LCM Dimensions | ----- | 14 |
| 9 Package information | ----- | 15 |

Appendix: Inspection Standard



1. SCOPE

This specification covers the engineering requirements for the GFC1602M-BNFEJW5 liquid crystal module.

2. PRODUCT SPECIFICATIONS

2.1 General

- 16 × 2 dot matrix LCD
- STN(BLUE), Negative mode LCD panel
- Transmissive Normal temperature type
- 6 o'clock
- Multiplexing driving : 1/16duty, 1/5bias
- Controller IC : RW1063-0A-001 or Compatible
- Backlight: White

2.2 Mechanical Characteristics

| Item | Characteristic |
|--|--------------------|
| Dot configuration | 16 × 2 |
| Dot dimensions(mm) | 0.5 × 0.55 |
| Dot spacing (mm) | 0.57 × 0.62 |
| Module dimensions (Horizontal × Vertical × Thickness, mm) | 85 × 30 × 13.2 Max |
| Viewing area (Horizontal × Vertical, mm) | 65 × 16 |
| Active area (Horizontal × Vertical, mm) | 55.73 × 10.98 |
| Remark | |



2.3 Absolute Maximum Ratings (Without LED back-light)

| Characteristic | Symbol | Unit | Value |
|---------------------------|----------|------|----------------------|
| Operating Voltage (logic) | V_{DD} | V | -0.3 to +5.0 |
| Input Voltage | V_{IN} | V | -0.3 to $V_{DD}+0.3$ |

Note 1: Referenced to $V_{SS}=0V$

2.4 Electrical Characteristics (Without LED back-light)

| Characteristic | Symbol | Condition | Min. | Typ. | Max. | Unit |
|--------------------------|-----------------|-----------------|-------------|------|-------------|------|
| Operating Voltage(logic) | $V_{DD}-V_{SS}$ | -- | 4.7 | 5.0 | 5.3 | V |
| Input Voltage | V_{IH} | -- | $0.8V_{DD}$ | -- | V_{DD} | V |
| | V_{IL} | -- | V_{SS} | -- | $0.2V_{DD}$ | |
| Output Voltage | V_{OH} | $I_{OH}=-0.1mA$ | $0.8V_{DD}$ | -- | V_{DD} | V |
| | V_{HL} | $I_{OL}=0.1mA$ | V_{SS} | -- | $0.2V_{DD}$ | |

2.5 Optical Characteristics Absolute maximum ratings

| Item | Symbol | Rating | Unit |
|-----------------------------|--------|--------|------|
| Operating temperature range | Top | -20~70 | °C |
| Storage temperature range | Tst | -30~80 | °C |



2.6. Optical Characteristics

1/16 duty, 1/5 bias, $V_{op}=4.2V$, $T_a=25^\circ C$

| Item | Symbol | Conditions | Min. | Typ. | Max | Reference |
|---------------------|-------------------------|------------------------------------|------|------|-------|-------------|
| Driving voltage | V_{op} | | 3.9 | 4.2 | 4.5 | |
| Viewing angle | θ_1 、 θ_2 | $C \geq 2.0, \Phi = 0^\circ$ C | 30° | - | - | Notes 1 & 2 |
| Contrast | C | $\theta = 5^\circ, \Phi = 0^\circ$ | 2.0 | - | - | Note 3 |
| Response time(rise) | t_{on} | $\theta = 5^\circ, \Phi = 0^\circ$ | - | 105 | 200ms | Note 4 |
| Response time(fall) | t_{off} | $\theta = 5^\circ, \Phi = 0^\circ$ | - | 78 | 200ms | Note 4 |

Note 1: Definition of angles θ and Φ

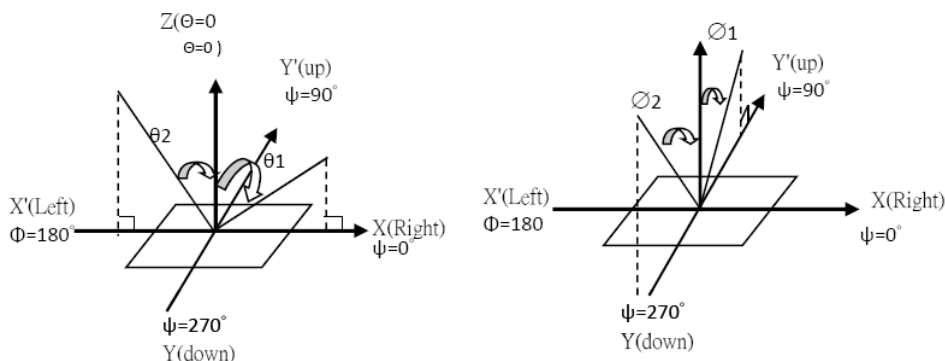

Note 2: Definition of viewing angles θ_1 and θ_2

Note 3: Definition of contrast C

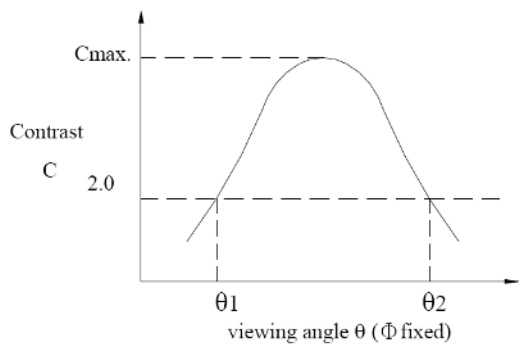

Note : Optimum viewing angle with the naked eye and viewing angle θ at C_{max} . Above are not always the same

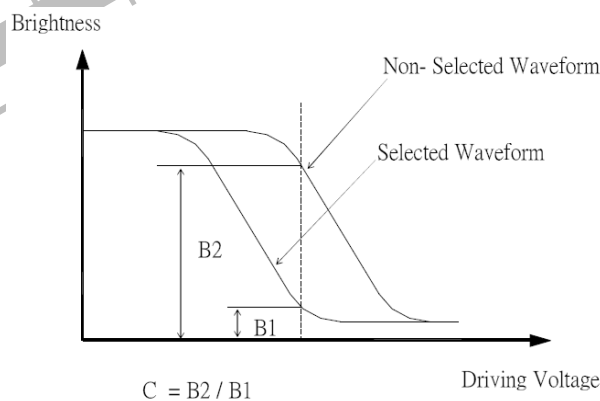

Note 4: Definition of response time

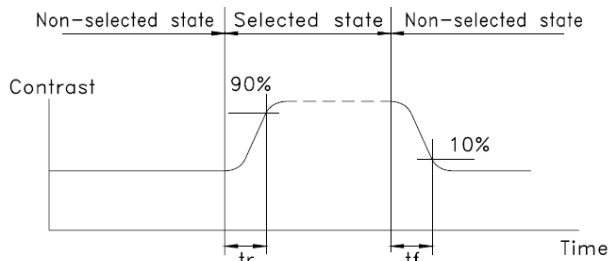

Note: Measured with a transmissive LCD panel which is displayed 1 cm²

V_{OPR} : Operating voltage

f_{FRM} : Frame frequency

t_{ON} : Response time (rise) t_{OFF} : Response time (fall)



2.7 LED Back-light Characteristics

2.7.1 Electrical / optical specifications

Ta = 25°C

| Item | Symbol | Condition | Min. | Typ. | Max. | Unit |
|----------------------------|--------------|-------------------|------|------|------|-------------------|
| Forward voltage | V_f | If=40mA, White | 2.8 | 3.1 | 3.4 | V |
| LED *Luminous Intensity | I_v | If=40mA, White | 500 | 900 | -- | cd/m ² |
| Chromaticity Coordinate | x | If=40mA, White | 0.27 | -- | 0.31 | |
| | y | | 0.27 | -- | 0.31 | |
| Luminous Uniformity | ΔL_v | If=40mA, White | 70 | | | % |

Note: * Measured at the bare LED back-light unit.

2.7.2 LED Maximum Operating Range

| Item | Symbol | WHITE | Unit |
|-------------------|----------|-------|------|
| Power Dissipation | P_{AD} | 660 | mW |
| Forward Current | I_F | 60 | mA |
| Reverse Voltage | V_R | 5 | V |



3. RELIABILITY

| NO. | ITEM | CONDITION | | STANDARD | NOTE |
|-----|---------------------------------|---|---------|------------------------------|-----------|
| 1 | High Temp. Storage | 80°C | 120 hrs | Appearance Without defect | |
| 2 | Low Temp. Storage | -30°C | 120 hrs | Appearance Without defect | |
| 3 | High Temp. & High Humi. Storage | 40°C 90% RH | 120 hrs | Appearance Without defect | |
| 4 | High Temp. Operating Display | 70°C | 120 hrs | Appearance Without defect | |
| 5 | Low Temp. Operating Display | -20°C | 120 hrs | Appearance Without defect | |
| 6 | Thermal Shock | -20°C, 30min. → 70°C, 30min. ↑ (1cycle) | | Appearance Without defect | 10 cycles |

** Dissipation current, contrast and display functions

** Polarizing filter deterioration, other appearance defects

** The function test shall be conducted after 4hours storage at the normal temperature and humidity after remove from the test chamber.



4. OPERATING INSTRUCTIONS

4.1 Input signal Function

| NO. | Symbol | Function |
|------|---------|----------------------------------|
| 1 | VDD | Power supply for Logic circuit |
| 2 | VSS | Ground (0V) |
| 3 | VO | Power Supply for Driving the LCD |
| 4 | RS | Data / Instruction select |
| 5 | R/W | Read / Write select |
| 6 | E | Enable signal |
| 7-14 | DB0-DB7 | Data Bus line |

4.2 Voltage Generator Circuit

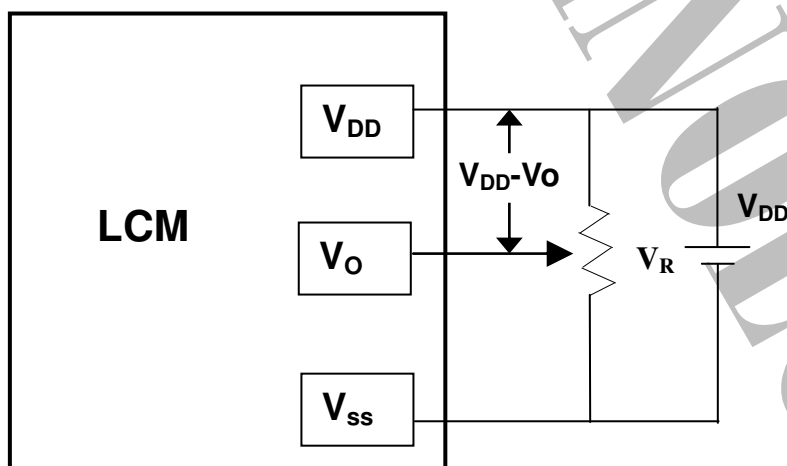

V_{DD}-V_O : LCD Driving Voltage
V_R : 10K~20K



4.3 Timing Diagram

- Writing data from MPU to RW1063 (Parallel 8-bit bus and 4-bit bus)

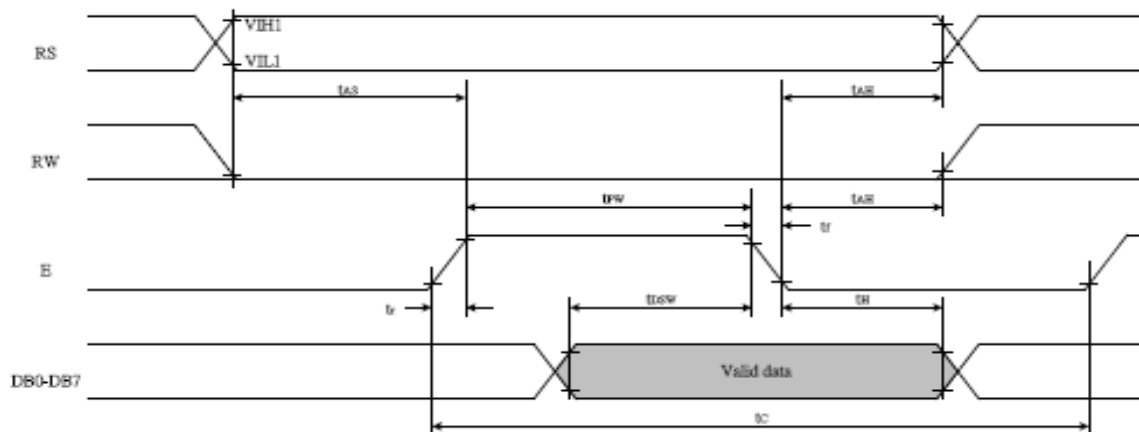

- Reading data from RW1063 to MPU (Parallel 8-bit bus and 4-bit bus)

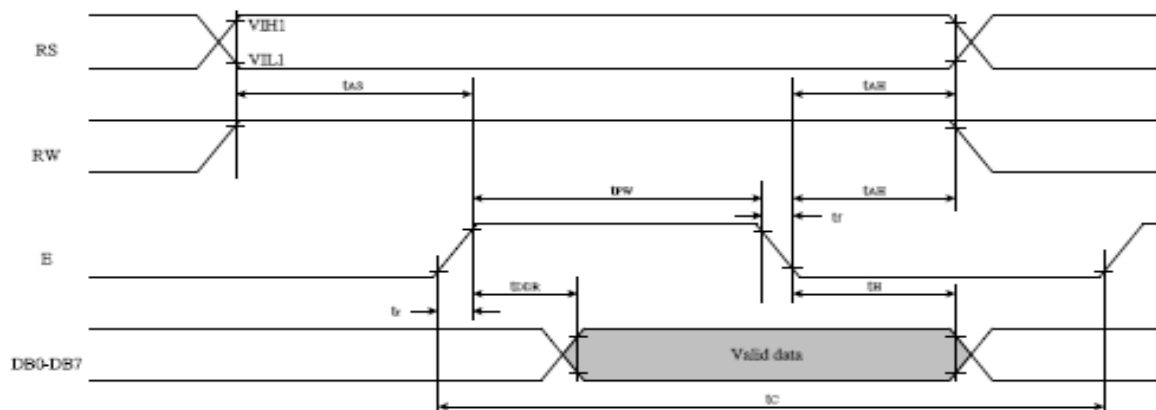

Write Mode (Writing data from MPU to RW1063)

| | | | | | | |
|------------|-----------------------|---------------------------------|-----|---|----|----|
| T_C | Enable Cycle Time | Pin E (except clear display) | 500 | - | - | ns |
| T_{PW} | Enable Pulse Width | Pin E | 230 | - | - | ns |
| T_R, T_F | Enable Rise/Fall Time | Pin E | - | - | 20 | ns |
| T_{AS} | Address Setup Time | Pins: RS, RW, E | 40 | - | - | ns |
| T_{AH} | Address Hold Time | Pins: RS, RW, E | 10 | - | - | ns |
| T_{DSW} | Data Setup Time | Pins: DB0 - DB7 | 80 | - | - | ns |
| T_H | Data Hold Time | Pins: DB0 - DB7 | 10 | - | - | ns |

Read Mode (Reading Data from RW1063 to MPU)

| | | | | | | |
|------------|-----------------------|-----------------|-----|---|-----|----|
| T_C | Enable Cycle Time | Pin E | 500 | - | - | ns |
| T_{PW} | Enable Pulse Width | Pin E | 230 | - | - | ns |
| T_R, T_F | Enable Rise/Fall Time | Pin E | - | - | 20 | ns |
| T_{AS} | Address Setup Time | Pins: RS, RW, E | 40 | - | - | ns |
| T_{AH} | Address Hold Time | Pins: RS, RW, E | 10 | - | - | ns |
| T_{DDR} | Data Setup Time | Pins: DB0 - DB7 | - | - | 120 | ns |
| T_H | Data Hold Time | Pins: DB0 - DB7 | 5 | - | - | ns |



4.4.Display Command

Instruction Table:

| Instruction | RS | RW | DB7 | DB6 | DB5 | DB4 | DB3 | DB2 | DB1 | DB0 | Description | Description Time (540KHz) |
|----------------------------|----|----|------------|-----|-----|-----|-----|-----|-----|-----|---|---------------------------|
| Read display data | 1 | 1 | Read data | | | | | | | | Read data from DDRAM/CGRAM | 18.5us |
| Write display data | 1 | 0 | Write data | | | | | | | | Write data into DDRAM/CGRAM | 18.5us |
| Clear Display | 0 | 0 | 0 | 0 | 0 | 0 | 0 | 0 | 0 | 1 | Write "20H" to DDRAM, and set DDRAM address to "00H" from AC | 0.76ms |
| Return Home | 0 | 0 | 0 | 0 | 0 | 0 | 0 | 0 | 1 | X | Set DDRAM address to "00H" from AC and return cursor to its original position if shifted. The contents of DDRAM are not changed. | 0.76ms |
| Entry Mode Set | 0 | 0 | 0 | 0 | 0 | 0 | 0 | 1 | I/D | S | Assign cursor moving direction and specify display shift. These operations are performed during data read and write. I/D="1": increment I/D="0": decrement | 18.5us |
| Display ON/OFF | 0 | 0 | 0 | 0 | 0 | 0 | 1 | D | C | B | Set Display /Cursor/Blink On/OFF D="1": display on D="0": display off C="1": cursor on C="0": cursor off B="1": blink on B="0": blink off | 18.5us |
| Cursor or Display shift | 0 | 0 | 0 | 0 | 0 | 1 | S/C | R/L | X | X | Cursor or display shift S/C="1": display shift S/C="0": cursor shift R/L="1": shift to right R/L="0": shift to left | 18.5us |
| Function Set | 0 | 0 | 0 | 0 | 1 | DL | N | F | X | X | Set Interface Data Length DL= 8-bit interface/ 4-bit interface N = 2-line/1-line display F= 5x8 Font Size / 5x11Font Size | 18.5us |
| Set CGRAM Address | 0 | 0 | 0 | 1 | AC5 | AC4 | AC3 | AC2 | AC1 | AC0 | Set CGRAM address in address counter | 18.5us |
| Set DDRAM Address | 0 | 0 | 1 | AC6 | AC5 | AC4 | AC3 | AC2 | AC1 | AC0 | Set DDRAM address in address counter | 18.5us |
| Read Busy Flag and Address | 0 | 1 | BF | AC6 | AC5 | AC4 | AC3 | AC2 | AC1 | AC0 | Can know internal operation is ready or not by reading BF. The contents of address counter can also be read. BF="1": busy state BF="0": ready state | 0us |

Note : 1. When an MPU program with Busy Flag(DB7) checking is made, 1/2 FOSC (is necessary) for executing the next instruction by the " E " signal after the Busy Flag (DB7) goes to " Low " .

2. "X" Don't care





5. Character Pattern

RW1063 Font table (0A-001)

| b7~4 b3~0 | 0000 | 0001 | 0010 | 0011 | 0100 | 0101 | 0110 | 0111 | 1000 | 1001 | 1010 | 1011 | 1100 | 1101 | 1110 | 1111 |
|--------------|-------------------|------|------|------|------|------|------|------|------|------|------|------|------|------|------|------|
| 0000 | CG RAM [00] | | | 0 | a | P | ^ | P | | | | — | 9 | 3 | 0 | P |
| 0001 | CG RAM [01] | | 1 | l | Q | a | 9 | | | | u | 7 | + | 4 | 3 | 9 |
| 0010 | CG RAM [02] | | " | 2 | B | R | b | r | | | r | 7 | 9 | x | R | 6 |
| 0011 | CG RAM [03] | | * | 3 | O | S | o | s | | | J | 0 | T | E | 3 | 3 |
| 0100 | CG RAM [04] | | * | 4 | D | T | d | t | | | v | T | T | H | H | 3 |
| 0101 | CG RAM [05] | | % | 5 | E | U | e | u | | | - | * | * | 1 | 3 | 0 |
| 0110 | CG RAM [06] | | & | 6 | F | V | f | v | | | 7 | 0 | 2 | 3 | P | 2 |
| 0111 | CG RAM [07] | | 7 | 7 | Q | U | q | u | | | 7 | * | 2 | 9 | 9 | 7 |
| 1000 | CG RAM [00] | | Q | 8 | H | X | h | x | | | 4 | 0 | * | 0 | 7 | 2 |
| 1001 | CG RAM [01] | | 2 | 9 | I | Y | i | y | | | 6 | T | J | U | U | 9 |
| 1010 | CG RAM [02] | | * | * | J | Z | j | z | | | 2 | 0 | 0 | U | U | 7 |
| 1011 | CG RAM [03] | | + | * | K | L | k | l | | | * | T | 6 | 0 | * | 7 |
| 1100 | CG RAM [04] | | , | < | L | Y | l | l | | | 6 | 0 | 0 | 0 | 0 | 0 |
| 1101 | CG RAM [05] | | — | = | M | N | m | n | | | 2 | 2 | * | U | U | + |
| 1110 | CG RAM [06] | | . | > | N | n | n | * | | | 3 | 6 | * | * | n | |
| 1111 | CG RAM [07] | | / | ? | O | L | o | e | | | w | U | 7 | " | 0 | ■ |



6. NOTES

▪ Safety

- If the LCD panel breaks, be careful not to get the liquid crystal in your mouth. If the liquid crystal touches your skin or clothes, wash it off immediately using soap and plenty of water.

Handling

- Avoid static electricity as this can damage the CMOS LSI.
- The LCD panel is plate glass; do not hit or crush it.
- Do not remove the panel or frame from the module.
- The polarizing plate of the display is very fragile; handle it very carefully

Mounting and Design

- Mount the module by using the specified mounting part and holes.
- To protect the module from external pressure, leave a small gap by placing transparent plates (e.g. acrylic or glass) on the display surface, frame, and polarizing plate
- Design the system so that no input signal is given unless the power-supply voltage is applied.
- Keep the module dry. Avoid condensation, otherwise the transparent electrodes may break.

Storage

- Store the module in a dark place where the temperature is $25^{\circ}\text{C} \pm 10^{\circ}\text{C}$ and the humidity below 65% RH.
- Do not store the module near organic solvents or corrosive gases.
- Do not crush, shake, or jolt the module (including accessories).

Cleaning

- Do not wipe the polarizing plate with a dry cloth, as it may scratch the surface.
- Wipe the module gently with soft cloth soaked with a petroleum benzine.
- Do not use ketonic solvents (ketone and acetone) or aromatic solvents (toluene and xylene), as they may damage the polarizing plate.

7. OPERATION PRECAUTIONS

Any changes that need to be made in this specification or any problems arising from it will be dealt with quickly by discussion between both companies.

Quality warranty period: Within one year after shipment date (excluding abnormal usage way and abnormal environments.)



8. LCM Dimension

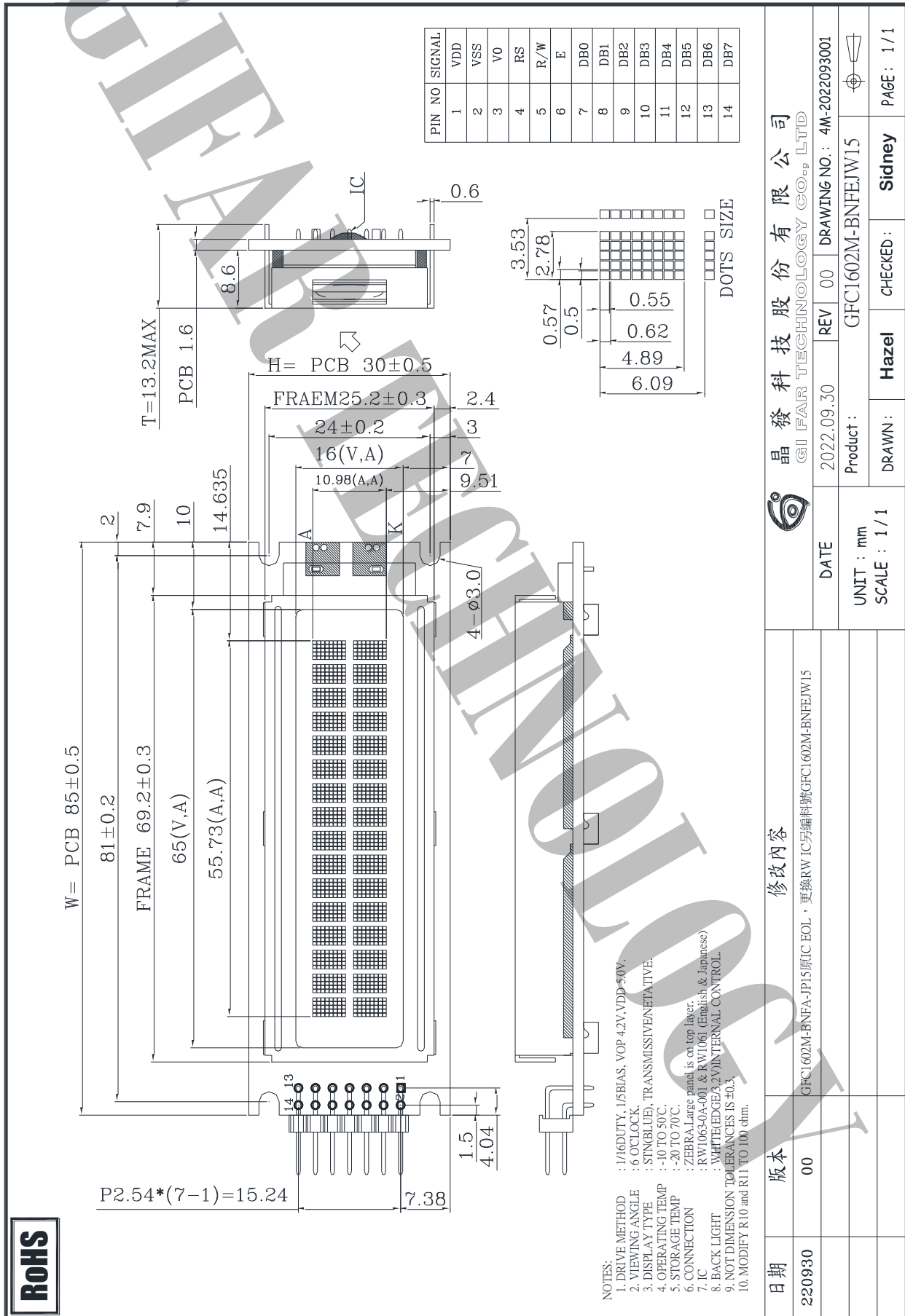



9. PACKAGE INFORMATION

| | | | |
|---|----------------------|---|---|
| 1 | 1 Tray | : | 20 pcs (modules) |
| 2 | 1 stack | : | 11 tray +1 Cover tray |
| 3 | 1 Carton | : | (1 Cover tray + 11 tray)x 2 stack |
| 4 | Total pcs | : | 1 Carton (20pcs*11tray * 2 stack) = 440 pcs |
| 5 | Carton size = NO. 17 | : | 495*315*435mm |
| 7 | Net weight | : | 14 KG |
| 8 | Gross weight | : | 19 KG |

** Packaging information**

- 1 Tray = 20 pcs



- 1 stack=11 tray+1 Cover tray



**Each layer of tray should be staggered stacked



- 1 Carton = 2 stack, Total pcs = 440 pcs

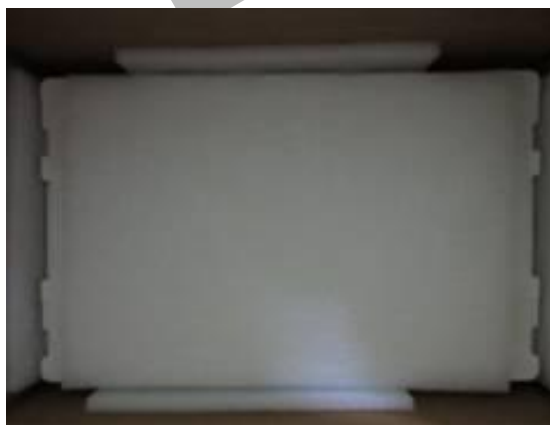

出貨檢驗標準書
Shipping inspection standard

| 核准 Approved by | 審核 Checked by | 作成 Made by |
|-------------------|------------------|---------------|
| ANDY | JACKY | RUBY |

1.目的 Purpose :

規範出貨產品之檢驗項目及判斷標準，確保產品出貨能滿足客戶要求。

Standardize the inspection items and judgment standards to ensure the products that shipped out can meet customer's requirements.

2.範圍 Area :

適用於出廠之所有產品。

Applicable to all products shipped from the factory.

3.名詞解釋 Explanation of terms :

3-1 主要缺陷：亦會造成功能缺失或嚴重外觀缺陷。

Major Defects: It also causes loss of function or serious appearance defects.

3-2 次要缺陷：稍有缺陷但不影響客戶使用。

Minor defect: Slightly defective but does not affect customer use.

4.檢驗體制 Inspection system :

4-1 抽樣計劃：依 ANSI/ASQ Z1.4 一般檢驗水準 II 之 正常檢驗一次抽驗方案。

Sampling plan: According to ANSI/ASQ Z1.4 general inspection level II the normal inspection one-time sampling plan.

4-2 允收水準 Acceptable Level : (AQL)

主要缺陷 Major defect : 0.4 %

次要缺陷 Minor defect : 0.65 %

5.檢驗條件 Inspection conditions :

5-1 使用相關之檢測儀器及測試、量測工具。

Use relevant testing instrument, testing and measuring tools .

5-2 環境要求：其條件需控制在常溫下 $23^{\circ}\text{C}\pm 3^{\circ}\text{C}$ 及溼度 70%RH 以下。

Environmental requirements: The conditions should be controlled at room temperature $23^{\circ}\text{C}\pm 3^{\circ}\text{C}$ and humidity below 70%RH.

5-3 外觀檢驗：須在 $380\pm 20\%$ LUX 的白色日光燈下，其目視距離需於產品離 30 ± 5 cm 檢驗。

Appearance inspection: Under the white fluorescent lamp of $380\pm 20\%$ LUX , the visual distance shall be checked above the product 30 ± 5 cm.

5-4 電性測試 Electrical Testing :

5-4-1 有背光之產品需關燈並在 $5\sim 300\text{Lux}\pm 3\%$ 下檢驗。

The products with backlight should be tested at $5\sim 300\pm 3\%$ Lux.

5-4-2 無背光之產品需開燈並在 $60\sim 300\text{Lux}\pm 3\%$ 白色日光燈下檢驗。

Products without backlight need to be turned on and tested under $60\sim 300 \pm 3\%$ LUX white fluorescent lamps .

5-5 檢查視角依產品視角方向。

Check the viewing angle according to the product viewing angle.

5-6 其不良現象檢視區域 Bad phenomenon View area

5-6-1 適用種類 Applicable category : COB、TFT



5-6-2 適用種類 Applicable category : COG、TAB、TN



6. 檢驗標準 Inspection standards

COB

| 種類 Category | | COB | | | | | | | | | | | | | | | | | | | |
|---|------------------------|---|---|------------------|-------------------------|-----------------------|---------------------|------------------------|------------|------------------------|---------------|------------------|-------------------------|-------------------------|------------------|-------------------------|------------|---|---|------------------|-------------------------|
| 編號 No. | 檢驗項目 Item | 檢驗內容及判定標準 Inspection Content & Standard | 區域 Zone | 類別 Category | 缺陷等級 Level | | | | | | | | | | | | | | | | |
| 1 | 點類(一) Dot (1) | 黑點、刺傷...等圓狀 Black dot、Stab...and other round shape $\varphi = \frac{(X + Y)}{2}$  | 兩點距離須超過 5 mm Two points have to be ≥ 5 mm <table border="1"> <thead> <tr> <th>φ (mm)</th> <th>允收數 Acceptance Qty</th> </tr> </thead> <tbody> <tr> <td>$\phi \leq 0.1$</td> <td>無視 Ignore</td> </tr> <tr> <td>$0.1 < \phi \leq 0.25$</td> <td>3</td> </tr> <tr> <td>$0.25 < \phi \leq 0.3$</td> <td>1</td> </tr> <tr> <td>$\phi > 0.3$</td> <td>0</td> </tr> </tbody> </table> | φ (mm) | 允收數 Acceptance Qty | $\phi \leq 0.1$ | 無視 Ignore | $0.1 < \phi \leq 0.25$ | 3 | $0.25 < \phi \leq 0.3$ | 1 | $\phi > 0.3$ | 0 | A | 外觀 Appearance | 次要 Minor AQL0.65% | | | | | |
| | | φ (mm) | 允收數 Acceptance Qty | | | | | | | | | | | | | | | | | | |
| $\phi \leq 0.1$ | 無視 Ignore | | | | | | | | | | | | | | | | | | | | |
| $0.1 < \phi \leq 0.25$ | 3 | | | | | | | | | | | | | | | | | | | | |
| $0.25 < \phi \leq 0.3$ | 1 | | | | | | | | | | | | | | | | | | | | |
| $\phi > 0.3$ | 0 | | | | | | | | | | | | | | | | | | | | |
| 其點位於側邊 無視 The dot is located on the side(B area)-OK <table border="1"> <thead> <tr> <th>φ (mm)</th> <th>允收數 Acceptance Qty</th> </tr> </thead> <tbody> <tr> <td>$\phi \leq 0.3$</td> <td>無視 Ignore</td> </tr> <tr> <td>$0.3 < \phi \leq 0.5$</td> <td>3</td> </tr> <tr> <td>$0.5 < \phi \leq 1$</td> <td>1</td> </tr> <tr> <td>$\phi > 1$</td> <td>0</td> </tr> </tbody> </table> | φ (mm) | 允收數 Acceptance Qty | $\phi \leq 0.3$ | 無視 Ignore | $0.3 < \phi \leq 0.5$ | 3 | $0.5 < \phi \leq 1$ | 1 | $\phi > 1$ | 0 | B | 外觀 Appearance | 次要 Minor AQL0.65% | | | | | | | | |
| φ (mm) | 允收數 Acceptance Qty | | | | | | | | | | | | | | | | | | | | |
| $\phi \leq 0.3$ | 無視 Ignore | | | | | | | | | | | | | | | | | | | | |
| $0.3 < \phi \leq 0.5$ | 3 | | | | | | | | | | | | | | | | | | | | |
| $0.5 < \phi \leq 1$ | 1 | | | | | | | | | | | | | | | | | | | | |
| $\phi > 1$ | 0 | | | | | | | | | | | | | | | | | | | | |
| 2 | 點類(二) Dot (2) | 氣泡、凹凸點 Bubble、Uneven dots $\varphi = \frac{(X + Y)}{2}$  | 兩點距離須超過 5 mm Two points to be ≥ 5 mm <table border="1"> <thead> <tr> <th>φ (mm)</th> <th>允收數 Acceptance Qty</th> </tr> </thead> <tbody> <tr> <td>$\phi \leq 0.2$</td> <td>無視 Ignore</td> </tr> <tr> <td>$0.2 < \phi \leq 0.5$</td> <td>2</td> </tr> <tr> <td>$\phi > 0.5$</td> <td>0</td> </tr> </tbody> </table> | φ (mm) | 允收數 Acceptance Qty | $\phi \leq 0.2$ | 無視 Ignore | $0.2 < \phi \leq 0.5$ | 2 | $\phi > 0.5$ | 0 | A | 外觀 Appearance | 次要 Minor AQL0.65% | | | | | | | |
| φ (mm) | 允收數 Acceptance Qty | | | | | | | | | | | | | | | | | | | | |
| $\phi \leq 0.2$ | 無視 Ignore | | | | | | | | | | | | | | | | | | | | |
| $0.2 < \phi \leq 0.5$ | 2 | | | | | | | | | | | | | | | | | | | | |
| $\phi > 0.5$ | 0 | | | | | | | | | | | | | | | | | | | | |
| 3 | 線類 Line | 刮傷、毛屑...等線狀 Scratch、Fiber.. and other linear shape.  | <table border="1"> <thead> <tr> <th>L (mm)</th> <th>W (mm)</th> <th>允收數 Acceptance Qty</th> </tr> </thead> <tbody> <tr> <td>--</td> <td>$W \leq 0.02$</td> <td>無視 Ignore</td> </tr> <tr> <td>$L \leq 5$</td> <td>$W \leq 0.03$</td> <td>3</td> </tr> <tr> <td>$L \leq 3$</td> <td>$W \leq 0.05$</td> <td>2</td> </tr> <tr> <td>$L > 5$</td> <td>$W > 0.05$</td> <td>0</td> </tr> </tbody> </table> | L (mm) | W (mm) | 允收數 Acceptance Qty | -- | $W \leq 0.02$ | 無視 Ignore | $L \leq 5$ | $W \leq 0.03$ | 3 | $L \leq 3$ | $W \leq 0.05$ | 2 | $L > 5$ | $W > 0.05$ | 0 | A | 外觀 Appearance | 次要 Minor AQL0.65% |
| L (mm) | W (mm) | 允收數 Acceptance Qty | | | | | | | | | | | | | | | | | | | |
| -- | $W \leq 0.02$ | 無視 Ignore | | | | | | | | | | | | | | | | | | | |
| $L \leq 5$ | $W \leq 0.03$ | 3 | | | | | | | | | | | | | | | | | | | |
| $L \leq 3$ | $W \leq 0.05$ | 2 | | | | | | | | | | | | | | | | | | | |
| $L > 5$ | $W > 0.05$ | 0 | | | | | | | | | | | | | | | | | | | |
| 4 | 底色 Background color | 同批供貨不能有明顯色差 No obvious color difference allowed in same shipment. (必要時與客端制定限度樣) (According to the gold samples if necessary) | A | 外觀 Appearance | 次要 Minor AQL0.65% | | | | | | | | | | | | | | | | |

| | | | | | |
|----|--|--|----|-------------------|-------------------------|
| 5 | 零件位置 Parts position | 與工程 BOM 上標示不符 拒收 Different with the BOM marked Reject | C | 外觀 Appearance | 主要 Major AQL 0.4% |
| 6 | 板面潔淨 FPC/PCB's surface is clean | ※ 焊接面上附著錫渣、珠 拒收 Solder side has tin slag, beads or particle Reject ※ 焊接面上附著於過多錫油 拒收 Solder side has too much tin oil Reject | C | 外觀 Appearance | 次要 Minor AQL0.65% |
| 7 | 點、線類 (三) Dot、Line (3) | ※ 於全黑、白畫面下看見之區塊狀或線狀不良 拒收 There is a block or linear in the view area under the screen is whole black or white. Reject ※ 但依 2% ND Filter 遮蓋無視 允收 But after inspecting by 2% ND Filter without seeing block or linear, it is confirmed Acceptance | AA | 電訊 Electronics | 次要 Minor AQL0.65% |
| 8 | 點、線類 (四) Dot、Line (4) | 畫面中顯示出現黑、白、亮、異色點或線狀 There is a black, white, bright or other dot or lines showing in the view area. ※ 依編號 1、3 之判定標準 According to the inspection standard: No. 1 and 3. | AA | 電訊 Electronics | 次要 Minor AQL0.65% |
| 9 | 缺字 Lack of characters | 顯示時畫面缺少部份字元 拒收 Lacking part of characters in the view area. Reject | AA | 電訊 Electronics | 主要 Major AQL 0.4% |
| 10 | 無動作 No reaction | 顯示畫面一直處於起始畫面而無法進行切換 拒收 The display (view area) always shows in the initial screen and can't be switched to others. Reject | AA | 電訊 Electronics | 主要 Major AQL 0.4% |
| 11 | 無畫面 No display | 通電後，完全無任何畫面顯示 拒收 After connecting to the power, there is no display. Reject | AA | 電訊 Electronics | 主要 Major AQL 0.4% |
| 12 | 斷線 Broken line | 顯示畫面中少直、橫線 拒收 There is a lack of vertical or horizontal lines in the view area. Reject | AA | 電訊 Electronics | 主要 Major AQL 0.4% |
| 13 | CROSS TALK | 顯示畫面時有局部之條紋或拖影 There are some stripes or shadow/smear showing in the view area. 拒收或與客端簽訂限度樣 Reject or inspect according to the golden sample | AA | 電訊 Electronics | 次要 Minor AQL0.65% |

| | | | | | |
|----|---------------------------------------|---|-----|---------------------------------------|-------------------------|
| 14 | I CON | 顯示畫面缺少部份顯示圖案 拒收 Lack of partial ICON in the view area. Reject | AA | 電訊 Electronics | 主要 Major AQL 0.4% |
| 15 | 深淺不一 Color difference | 顯示畫面的對比，比其他顯示深或淺並依電氣規格(VOP) 值判定 The contrast of display is obviously lighter or darker than others and according to the VOP value in the electronics specification. 拒收或與客端簽訂限度樣 Reject or inspect according to the golden sample | AA | 電訊 Electronics | 次要 Minor AQL0.65% |
| 16 | 畫面異常 Abnormal screen | 通電後畫面出現未定義之電訊不良現象 拒收 After connecting to the power, there is an undefined electronics appearance showing in the view area. Reject | AA | 電訊 Electronics | 主要 Major AQL 0.4% |
| 17 | 背光色不均 Uneven color of backlight | ※ 點亮後 LED 有明暗不均現象依其均勻度判定 拒收 After lighting LEDs have brightness and darkness uneven the determined according to its uniformity. Reject ※ 點亮後 LED 色澤不一致 拒收 LED color is inconsistent after lighting Reject | A | 電訊 Electronics | 次要 Minor AQL0.65% |
| 18 | 亮度不足 Lack of brightness | 波長、色座標、輝度與圖面標示定義不符 拒收 Wave length, chromatic coordinates, brightness don't correspond to the definition of the drawing. Reject | A | 電訊 Electronics | 次要 Minor AQL0.65% |
| 19 | 尺寸量測 Size Measurement | 未依圖面上標示 拒收 No correspond to the indication on the drawing. Reject | ALL | 外觀 Appearance | 主要 Major AQL 0.4% |
| 20 | 其他 Other | 如發現有上述未定義之不良則與客端簽訂限度樣 If there is another undefined defective situation. It will be listed as others. The inspection standard is according to the golden sample. | ALL | 電訊 Electronics 外觀 Appearance | 次要 Minor AQL0.65% |