

Notice for TAIYO YUDEN products

Please read this notice before using the TAIYO YUDEN products.

REMINDERS

- Product information in this catalog is as of October 2009. All of the contents specified herein are subject to change without notice due to technical improvements, etc. Therefore, please check for the latest information carefully before practical application or usage of the Products.

Please note that Taiyo Yuden Co., Ltd. shall not be responsible for any defects in products or equipment incorporating such products, which are caused under the conditions other than those specified in this catalog or individual specification.

- Please contact Taiyo Yuden Co., Ltd. for further details of product specifications as the individual specification is available.
- Please conduct validation and verification of products in actual condition of mounting and operating environment before commercial shipment of the equipment.
- All electronic components or functional modules listed in this catalog are developed, designed and intended for use in general electronics equipment.(for AV, office automation, household, office supply, information service, telecommunications, (such as mobile phone or PC) etc.). Before incorporating the components or devices into any equipment in the field such as transportation,(automotive control, train control, ship control), transportation signal, disaster prevention, medical, public information network (telephone exchange, base station) etc. which may have direct influence to harm or injure a human body, please contact Taiyo Yuden Co., Ltd. for more detail in advance. Do not incorporate the products into any equipment in fields such as aerospace, aviation, nuclear control, submarine system, military, etc. where higher safety and reliability are especially required.

In addition, even electronic components or functional modules that are used for the general electronic equipment, if the equipment or the electric circuit require high safety or reliability function or performances, a sufficient reliability evaluation check for safety shall be performed before commercial shipment and moreover, due consideration to install a protective circuit is strongly recommended at customer's design stage.

- The contents of this catalog are applicable to the products which are purchased from our sales offices or distributors (so called "TAIYO YUDEN' s official sales channel").
It is only applicable to the products purchased from any of TAIYO YUDEN' s official sales channel.
- Please note that Taiyo Yuden Co., Ltd. shall have no responsibility for any controversies or disputes that may occur in connection with a third party's intellectual property rights and other related rights arising from your usage of products in this catalog. Taiyo Yuden Co., Ltd. grants no license for such rights.

■ Caution for export

Certain items in this catalog may require specific procedures for export according to "Foreign Exchange and Foreign Trade Control Law" of Japan, "U.S. Export Administration Regulations", and other applicable regulations. Should you have any question or inquiry on this matter, please contact our sales staff.
Should you have any question or inquiry on this matter, please contact our sales staff.

HIGH VALUE MULTILAYER CERAMIC CAPACITORS



WAVE

REFLOW

FEATURES

- The use of nickel as electrode material and plating processing improve the solderability and heat resistance characteristics. It also prevents migration and raises the level of reliability.
- Low equivalent series resistance(ESR) provides superior noise absorption characteristics.
- Compared to tantalum or aluminum electrolytic capacitors, multilayer ceramic capacitors offer a number of superior features, including:
Higher permissible ripple current values
Smaller case sizes with high rated voltage
Improved reliability due to higher insulation resistance and breakdown voltage.

APPLICATIONS

- General digital circuit
- Power supply bypass capacitors
Liquid crystal modules
Liquid crystal drive voltage lines
LSI, IC, converters(both for input and output)
- Smoothing capacitors
DC-DC converters (for both input and output)
Switching power supplies (secondary side)

ORDERING CODE

J | M | K | 3 | 1 | 6 | B | J | 1 | 0 | 6 | M | L | - | T | △

1 Rated voltage (VDC)

| | |
|---|-----|
| A | 4 |
| J | 6.3 |
| L | 10 |
| E | 16 |
| T | 25 |
| G | 35 |
| U | 50 |

2 Series name

M Multilayer ceramic capacitor

3 End termination

| | |
|---|--------|
| K | Plated |
|---|--------|

4 Dimensions (EIA) L×W (mm)

| | |
|------------|----------|
| 107 (0603) | 1.6×0.8 |
| 212 (0805) | 2.0×1.25 |
| 316 (1206) | 3.2×1.6 |
| 325 (1210) | 3.2×2.5 |

5 Temperature characteristics code

| | |
|----|-----|
| BJ | B |
| | X5R |
| B7 | X7R |
| △F | F |
| | Y5V |

△=Blank space

6 Nominal capacitance (pF)

| | |
|---------|-----------|
| example | |
| 473 | 47,000 |
| 105 | 1,000,000 |

7 Capacitance tolerance

| | |
|---|--------------|
| K | ±10% |
| M | ±20% |
| Z | +80% -20% |

8 Thickness (mm)

| | |
|---|--------|
| K | 0.45 |
| A | 0.8 |
| D | 0.85 |
| L | 1.6 |
| N | 1.9 |
| Y | 2.0max |
| M | 2.5 |

9 Special code

| | |
|---|------------------|
| - | Standard product |
|---|------------------|

10 Internal code

| | |
|---|------------------|
| △ | Standard product |
|---|------------------|

△=Blank space

11 Packaging

| | |
|---|--|
| T | φ178mm Taping (4mm pitch) All types |
| P | φ178mm Taping (4mm pitch, 1000pcs/reel) 1210Type Thickness : M |

EXTERNAL DIMENSIONS/STANDARD QUANTITY

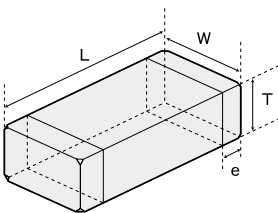

Note:

- *1. Including dimension tolerance ± 0.15mm (±0.006 inch).
- *2. Including dimension tolerance ± 0.3mm (±0.012 inch).
- *3. Including dimension tolerance ± 0.2mm (±0.008 inch).
- *4. Including dimension tolerance + 0.15/-0.1mm (+0.006/-0.004 inch).

| Type(EIA) | L | W | T | | e | Standard quantity [pcs] | |
|---------------|---|--|--|-----------|--|-------------------------|---------------|
| | | | Capacitance (pF) | Tolerance | | Paper tape | Embossed tape |
| □MK107 (0603) | 1.6±0.10 ^{-3,4} (0.063±0.004) | 0.8±0.10 ^{-3,4} (0.031±0.004) | 0.45±0.05(0.018±0.002) | K | 0.35±0.25 (0.014±0.010) | 4000 | — |
| | | | 0.8±0.10 ^{-3,4} (0.031±0.004) | A | | | |
| □MK212 (0805) | 2.0±0.10 ^{-1,3} (0.079±0.004) | 1.25±0.10 ^{-1,3} (0.049±0.004) | 0.45±0.05(0.018±0.002) | K | 0.5±0.25 (0.020±0.010) | 4000 | — |
| | | | 0.85±0.10(0.033±0.004) | D | | | |
| | | | 1.25±0.10 ^{-1,3} (0.049±0.004) | G | | | |
| □MK316 (1206) | 3.2±0.15 ⁻³ (0.126±0.006) | 1.6±0.15 ⁻³ (0.063±0.006) | 0.85±0.10(0.033±0.004) | D | 0.5 ^{+0.25} _{-0.25} (0.020±0.014) | 4000 | — |
| | | | 1.25±0.10(0.049±0.004) | G | | | |
| | | | 1.6±0.20(0.063±0.008) | L | | | |
| | | | 0.85±0.10(0.033±0.004) | D | | | |
| □MK325 (1210) | 3.2±0.30 (0.126±0.012) | 2.5±0.20 ⁻² (0.098±0.008) | 1.9±0.20(0.075±0.008) | N | 0.6±0.3 (0.024±0.012) | — | 2000 |
| | | | 1.9 ^{+0.1} _{-0.2} (0.075 ^{+0.004} _{-0.008}) | Y | | | |
| | | | 2.5±0.20 ⁻² (0.098±0.008) | M | | | |
| | | | | | | | |

Unit : mm (inch)

AVAILABLE CAPACITANCE RANGE

| Cap (μF) | Type | 107 | | | | 212 | | | | 316 | | | | 325 | | | |
|----------|------|-----|-------|-----|-------|-----|-------|-----|-------|-----|-------|-----|-------|-----|-------|-----|-------|
| | | X7R | B/X5R | X5R | F/Y5V | X7R | B/X5R | X5R | F/Y5V | X7R | B/X5R | X5R | F/Y5V | X7R | B/X5R | X5R | F/Y5V |
| 0.1 | 104 | | | | A | | | G | | | | | | | | | |
| 0.15 | 154 | | | | | | | | | | | | | | | | |
| 0.22 | 224 | A | A | A | | | A | G | | | | | | | | | |
| 0.33 | 334 | | | | | | | | | | | | | | | | |
| 0.47 | 474 | A | A | A | | | A | A | G | | | | | | | | |
| 0.68 | 684 | | | | | | | | | | | | | | | | |
| 1 | 105 | A | A | A | A | A | A | | G | G | G | | | | | | |
| 2.2 | 225 | | | | | | A | A | | G | G | | | | | | |
| 3.3 | 335 | | | | | | | | | | | | | | | | |
| 4.7 | 475 | | | | | | A | A | | G | G | G | | | | | |
| 6.8 | 685 | | | | | | | | | | | | | | | | |
| 10 | 106 | | | | | | A | A | A | | G | | | | | | |
| 22 | 226 | | | | | | | | | | | | | | | | |
| 47 | 476 | | | | | | | | | | | | | | | | |
| 100 | 107 | | | | | | | | | | | | | | | | |

Note : Letters in the table indicate thickness.

* This catalog contains the typical specification only due to the limitation of space. When you consider purchase of our products, please check our specification. For details of each product (characteristics graph, reliability information, precautions for use, and so on), see our Web site (<http://www.ty-top.com/>) or CD catalogs.

● Low Profile Multilayer Ceramic Capacitors

| Type | 107 | | | | | | 212 | | | | | | 316 | | | | | | 325 | | | | | | | | | | | | |
|----------|-----|-------|-----|-----|-------|-----|-------|-------|-----|-------|-------|-----|-------|-------|-----|-------|-------|----|-----|-----|----|----|----|-----|----|----|----|-----|----|----|----|
| | TC | B/X5R | X5R | X7R | B/X5R | X5R | F/Y5V | B/X5R | X5R | F/Y5V | B/X5R | X5R | F/Y5V | B/X5R | X5R | F/Y5V | B/X5R | | | | | | | | | | | | | | |
| Cap [μF] | 10 | 6.3 | 25 | 16 | 10 | 6.3 | 16 | 10 | 25 | 16 | 10 | 6.3 | 50 | 10 | 6.3 | 50 | 25 | 16 | 10 | 6.3 | 25 | 16 | 10 | 6.3 | 50 | 35 | 10 | 6.3 | 25 | 16 | 10 |
| 0.1 | 104 | | | | | | | | | | | | | | | | | | | | | | | | | | | | | | |
| 0.22 | 224 | | | | | | | | | | | | | | | | | | | | | | | | | | | | | | |
| 0.33 | 334 | | | | | | | | | | | | | | | | | | | | | | | | | | | | | | |
| 0.47 | 474 | | | | | | | | | | | | | | | | | | | | | | | | | | | | | | |
| 0.68 | 684 | | | | | | | | | | | | | | | | | | | | | | | | | | | | | | |
| 1 | 105 | K | K | K | K | | D | D | D | D | | | | | | | | | | | | | | | | | | | | | |
| 2.2 | 225 | | | | | | K | K | D | D | | | | | | | | | | | | | | | | | | | | | |
| 3.3 | 335 | | | | | | | | | | | | | | | | | | | | | | | | | | | | | | |
| 4.7 | 475 | | | | | | | | | | | | | | | | | | | | | | | | | | | | | | |
| 6.8 | 685 | | | | | | | | | | | | | | | | | | | | | | | | | | | | | | |
| 10 | 106 | | | | | | | | | | | | | | | | | | | | | | | | | | | | | | |
| 22 | 226 | | | | | | | | | | | | | | | | | | | | | | | | | | | | | | |
| 47 | 476 | | | | | | | | | | | | | | | | | | | | | | | | | | | | | | |

Note : Letters in the table indicate thickness.

| Temp. char. Code | Temperature characteristics | | | | Capacitance tolerance (%) |
|------------------|-----------------------------|------------------------|-----------------|------------------------|---------------------------|
| | Applicable standard | Temperature range [°C] | Ref. Temp. [°C] | Capacitance change (%) | |
| BJ | JIS B | -25~+85 | 20 | ±10 | ±10 (K) |
| | EIA X5R | -55~+85 | 25 | ±15 | |
| B7 | EIA X7R | -55~+125 | 25 | ±15 | ±20 (M) |
| F | JIS F | -25~+85 | 20 | +30/-80 | +80 (Z) |
| | EIA Y5V | -30~+85 | 25 | +22/-82 | |

■ PART NUMBERS

● 107TYPE

[Temp.char. B: B/X5R]

| Rated Voltage | Ordering code | EHS (Environmental Hazardous Substances) | Capacitance [μF] | Temperature characteristics | Dissipation factor (%) Max. | Soldering method R:Reflow soldering W:Wave soldering | Capacitance tolerance | Thickness [mm] |
|-------------------------------|-------------------------------|--|------------------|-----------------------------|-----------------------------|--|-----------------------|----------------|
| 50V | UMK107 BJ105□A ¹ | RoHS | 1 | X5R | 10 | R | ±10% ±20% | 0.8±0.1 |
| 35V | GMK107 BJ105□A ¹ | RoHS | 1 | B/X5R | 5 | | | 0.8±0.1 |
| 25V | TMK107 BJ105□K ¹ | RoHS | 1 | X5R | 10 | R/W | | 0.45±0.05 |
| | TMK107 BJ224□A | RoHS | 0.22 | B/X5R | 3.5 | | | 0.8±0.1 |
| | TMK107 BJ474□A ¹ | RoHS | 0.47 | B/X5R | 3.5 | 0.8±0.1 | | |
| | TMK107 BJ105□A ¹ | RoHS | 1 | B/X5R | 5 | R | | 0.8±0.1 |
| 16V | EMK107 BJ105□K ¹ | RoHS | 1 | X5R | 10 | R/W | | 0.45±0.05 |
| | EMK107 BJ224□A | RoHS | 0.22 | B/X5R ² | 3.5 | | | 0.8±0.1 |
| | EMK107 BJ474□A | RoHS | 0.47 | B/X5R ² | 3.5 | 0.8±0.1 | | |
| | EMK107 BJ105□A ¹ | RoHS | 1 | B/X5R ² | 5 | R | | 0.8±0.1 |
| | EMK107 BJ225□A ¹ | RoHS | 2.2 | B/X5R | 10 | | 0.8±0.1 | |
| | EMK107 BJ225□K ¹ | RoHS | 2.2 | X5R | 10 | | 0.8±0.1 | |
| EMK107 BJ475MK ^{1,4} | RoHS | 4.7 | X5R | 10 | 0.45±0.05 | | | |
| 10V | LMK107 BJ224□A | RoHS | 0.22 | B/X5R ² | 3.5 | R/W | ±10% ±20% | 0.8±0.1 |
| | LMK107 BJ474□A | RoHS | 0.47 | B/X5R ² | 3.5 | 0.8±0.1 | | |
| | LMK107 BJ105□A ¹ | RoHS | 1 | B/X5R ² | 5 | 0.8±0.1 | | |
| | LMK107 BJ225□A ¹ | RoHS | 2.2 | B/X5R | 10 | 0.8±0.1 | | |
| | LMK107 BJ475□A ¹ | RoHS | 4.7 | X5R | 10 | 0.8±0.1 | | |
| | LMK107 BJ106MA ^{1,4} | RoHS | 10 | X5R | 10 | ±20% | | 0.8±0.2 |
| | JMK107 BJ105□K ¹ | RoHS | 1 | B/X5R | 10 | ±10% | | 0.45±0.05 |
| | JMK107 BJ225□K ¹ | RoHS | 2.2 | X5R | 10 | ±20% | | 0.45±0.05 |
| | JMK107 BJ475MK ¹ | RoHS | 4.7 | X5R | 10 | ±20% | | 0.45±0.05 |
| | JMK107 BJ225□A ¹ | RoHS | 2.2 | B/X5R | 10 | ±10% | | 0.8±0.1 |
| 6.3V | JMK107 BJ475□A ¹ | RoHS | 4.7 | X5R | 10 | ±20% | 0.8±0.1 | |
| | JMK107 BJ106MA ¹ | RoHS | 10 | X5R | 10 | ±20% | 0.8±0.1 | |
| | JMK107 BJ106MA ¹ | RoHS | 10 | X5R | 10 | | 0.8±0.1 | |
| | JMK107 BJ106MA ^{1,3} | RoHS | 22 | X5R | 10 | | 0.8±0.2 | |
| 4V | AMK107 BJ226MA ^{1,3} | RoHS | 22 | X5R | 10 | | 0.8±0.2 | |

[Temp.char. B7:X7R]

| Rated Voltage | Ordering code | EHS (Environmental Hazardous Substances) | Capacitance [μF] | Temperature characteristics | Dissipation factor (%) Max. | Soldering method R:Reflow soldering W:Wave soldering | Capacitance tolerance | Thickness [mm] |
|---------------|------------------------------|--|------------------|-----------------------------|-----------------------------|--|-----------------------|----------------|
| 16V | EMK107 B7 224□A ¹ | RoHS | 0.22 | X7R | 3.5 | R/W | ±10% ±20% | 0.8±0.1 |
| | EMK107 B7 474□A ¹ | RoHS | 0.47 | X7R | 3.5 | R | | 0.8±0.1 |
| | EMK107 B7 105□A ¹ | RoHS | 1 | X7R | 5 | | | 0.8±0.1 |
| 10V | LMK107 B7 224□A | RoHS | 0.22 | X7R | 3.5 | R/W | | 0.8±0.1 |
| | LMK107 B7 474□A | RoHS | 0.47 | X7R | 3.5 | R | | 0.8±0.1 |
| | LMK107 B7 105□A ¹ | RoHS | 1 | X7R | 5 | | | 0.8±0.1 |
| 6.3V | JMK107 B7 224□A | RoHS | 0.22 | X7R | 3.5 | R/W | | 0.8±0.1 |
| | JMK107 B7 474□A | RoHS | 0.47 | X7R | 3.5 | R | | 0.8±0.1 |
| | JMK107 B7 105□A ¹ | RoHS | 1 | X7R | 5 | | | 0.8±0.1 |

[Temp.char. F:F/Y5V]

| Rated Voltage | Ordering code | EHS (Environmental Hazardous Substances) | Capacitance [μF] | Temperature characteristics | Dissipation factor (%) Max. | Soldering method R:Reflow soldering W:Wave soldering | Capacitance tolerance | Thickness [mm] | |
|---------------|---------------|--|------------------|-----------------------------|-----------------------------|--|-----------------------|----------------|---------|
| 50V | UMK107 F104ZA | RoHS | 0.1 | F/Y5V | 7 | R/W | +80% -20% | 0.8±0.1 | |
| 25V | TMK107 F474ZA | RoHS | 0.47 | F/Y5V | 7 | | | 0.8±0.1 | |
| 16V | EMK107 F224ZA | RoHS | 0.22 | F/Y5V | 7 | | | R | 0.8±0.1 |
| | EMK107 F474ZA | RoHS | 0.47 | F/Y5V | 7 | | | | 0.8±0.1 |
| | EMK107 F105ZA | RoHS | 1 | F/Y5V | 16 | | | 0.8±0.1 | |
| | EMK107 F225ZA | RoHS | 2.2 | F/Y5V | 16 | | | 0.8±0.1 | |
| 10V | LMK107 F105ZA | RoHS | 1 | F/Y5V | 16 | R | | 0.8±0.1 | |
| | LMK107 F225ZA | RoHS | 2.2 | F/Y5V | 16 | | | 0.8±0.1 | |

□ Please specify the capacitance tolerance code. *1 1.5 times the rated voltage is applied to the chip during the high temperature loading test. *2 We may provide X7R for some items according to the individual specification. *3 The exchange of individual specification is necessary depending on the application and circuit condition. Please contact Taiyo Yuden sales channels. *4 "D" is used for the internal code.

* This catalog contains the typical specification only due to the limitation of space. When you consider purchase of our products, please check our specification. For details of each product (characteristics graph, reliability information, precautions for use, and so on), see our Web site (<http://www.ty-top.com/>) or CD catalogs.

PART NUMBERS

● 212TYPE

[Temp.char. B: B/X5R]

| Rated Voltage | Ordering code | EHS (Environmental Hazardous Substances) | Capacitance (μF) | Temperature characteristics | Dissipation factor (%) Max. | Soldering method R:Reflow soldering W:Wave soldering | Capacitance tolerance | Thickness (mm) |
|------------------------------|--------------------------------|--|------------------|-----------------------------|-----------------------------|--|-----------------------|----------------|
| 50V | UMK212 BJ104□G | RoHS | 0.1 | B/X5R ⁺² | 3.5 | R/W | ±10% | 1.25±0.1 |
| | UMK212 BJ224□G ⁺¹ | RoHS | 0.22 | B/X5R ⁺² | 3.5 | | | 1.25±0.1 |
| | UMK212 BJ474□G ⁺¹ | RoHS | 0.47 | B/X5R ⁺² | 3.5 | | | 1.25±0.1 |
| | UMK212 BJ105□G ⁺¹ | RoHS | 1 | X5R | 5 | | | 1.25±0.1 |
| 25V | TMK212 BJ474□D | RoHS | 0.47 | B/X5R | 3.5 | R | ±10% | 0.85±0.1 |
| | TMK212 BJ105□D | RoHS | 1 | B/X5R | 5 | | | 0.85±0.1 |
| | TMK212 BJ225□D ⁺¹ | RoHS | 2.2 | B/X5R | 5 | | | 0.85±0.1 |
| | TMK212 BJ475□D ⁺¹⁺⁴ | RoHS | 4.7 | X5R | 10 | | | 0.85±0.1 |
| | TMK212 BJ225□G ⁺¹ | RoHS | 2.2 | B/X5R | 5 | | | 1.25±0.1 |
| | TMK212 BJ475□G ⁺¹ | RoHS | 4.7 | X5R | 10 | | | 1.25±0.15 |
| | EMK212 BJ105□D | RoHS | 1 | B/X5R ⁺² | 5 | | | 0.85±0.1 |
| 16V | EMK212 BJ225□D | RoHS | 2.2 | B/X5R ⁺² | 5 | R | ±10% | 0.85±0.1 |
| | EMK212 BJ475□D ⁺¹ | RoHS | 4.7 | B/X5R | 10 | | | 0.85±0.1 |
| | EMK212 BJ106□D ⁺¹⁺⁴ | RoHS | 10 | X5R | 10 | | | 0.85±0.1 |
| | EMK212 BJ225□G | RoHS | 2.2 | B/X5R ⁺² | 5 | | | 1.25±0.1 |
| | EMK212 BJ475□G ⁺¹ | RoHS | 4.7 | B/X5R ⁺² | 5 | | | 1.25±0.15 |
| | EMK212 BJ106□G ⁺¹ | RoHS | 10 | X5R | 10 | | | 1.25±0.15 |
| 10V | LMK212 BJ475□K ⁺¹ | RoHS | 4.7 | X5R | 10 | R | ±20% | 0.45±0.05 |
| | LMK212 BJ105□D | RoHS | 1 | B/X5R ⁺² | 3.5 | | | 0.85±0.1 |
| | LMK212 BJ225□D | RoHS | 2.2 | B/X5R ⁺² | 5 | | | 0.85±0.1 |
| | LMK212 BJ475□D | RoHS | 4.7 | B/X5R | 10 | | | 0.85±0.1 |
| | LMK212 BJ106□D ⁺¹ | RoHS | 10 | X5R | 10 | | | 0.85±0.1 |
| | LMK212 BJ225□G | RoHS | 2.2 | B/X5R ⁺² | 5 | | | 1.25±0.1 |
| | LMK212 BJ475□G | RoHS | 4.7 | B/X5R ⁺² | 5 | | | 1.25±0.15 |
| | LMK212 BJ106□G | RoHS | 10 | X5R | 10 | | | 1.25±0.15 |
| | LMK212 BJ226MG ⁺¹ | RoHS | 22 | X5R | 10 | | | 1.25±0.2 |
| 6.3V | JMK212 BJ475□K ⁺¹ | RoHS | 4.7 | X5R | 10 | R | ±10% | 0.45±0.05 |
| | JMK212 BJ106MK ⁺¹ | RoHS | 10 | X5R | 10 | | | 0.45±0.05 |
| | JMK212 BJ475□D | RoHS | 4.7 | X5R | 10 | | | 0.85±0.1 |
| | JMK212 BJ106□D | RoHS | 10 | X5R | 10 | | | 0.85±0.1 |
| | JMK212 BJ226MD ⁺¹ | RoHS | 22 | X5R | 10 | | | 0.85±0.1 |
| | JMK212 BJ475□G | RoHS | 4.7 | B/X5R | 5 | | | 1.25±0.15 |
| | JMK212 BJ106□G | RoHS | 10 | X5R ⁺² | 10 | | | 1.25±0.15 |
| | JMK212 BJ226MG ⁺¹ | RoHS | 22 | X5R | 10 | | | 1.25±0.15 |
| JMK212 BJ476MG ⁺¹ | RoHS | 47 | X5R | 10 | 1.25±0.2 | | | |

[Temp.char. B7: X7R]

| Rated Voltage | Ordering code | EHS (Environmental Hazardous Substances) | Capacitance (μF) | Temperature characteristics | Dissipation factor (%) Max. | Soldering method R:Reflow soldering W:Wave soldering | Capacitance tolerance | Thickness (mm) | |
|---------------|-------------------------------|--|------------------|-----------------------------|-----------------------------|--|-----------------------|----------------|----------|
| 50V | UMK212 B7 104□G | RoHS | 0.1 | X7R | 3.5 | R/W | ±10% | 1.25±0.1 | |
| | UMK212 B7 224□G ⁺¹ | RoHS | 0.22 | X7R | 3.5 | | | 1.25±0.1 | |
| | UMK212 B7 474□G ⁺¹ | RoHS | 0.47 | X7R | 3.5 | | | 1.25±0.1 | |
| 35V | GMK212 B7 105□G ⁺¹ | RoHS | 1 | X7R | 3.5 | R | ±10% | 1.25±0.1 | |
| 25V | TMK212 B7 105□G ⁺¹ | RoHS | 1 | X7R | 5 | | | 1.25±0.1 | |
| 16V | EMK212 B7 474□D | RoHS | 0.47 | X7R | 3.5 | R/W | ±10% | 0.85±0.1 | |
| | EMK212 B7 105□D | RoHS | 1 | X7R | 5 | R | | 0.85±0.1 | |
| | EMK212 B7 225□D ⁺¹ | RoHS | 2.2 | X7R | 5 | R | | 0.85±0.1 | |
| | EMK212 B7 105□G | RoHS | 1 | X7R | 3.5 | R/W | | 1.25±0.1 | |
| | EMK212 B7 225□G ⁺¹ | RoHS | 2.2 | X7R | 10 | R | | 1.25±0.1 | |
| | EMK212 B7 475□G ⁺¹ | RoHS | 4.7 | X7R | 10 | | | 1.25±0.1 | |
| 10V | LMK212 B7 105□D | RoHS | 1 | X7R | 3.5 | R | ±20% | 0.85±0.1 | |
| | LMK212 B7 225□D | RoHS | 2.2 | X7R | 5 | | | 0.85±0.1 | |
| | LMK212 B7 105□G | RoHS | 1 | X7R | 3.5 | | | R/W | 1.25±0.1 |
| | LMK212 B7 225□G | RoHS | 2.2 | X7R | 5 | | | R | 1.25±0.1 |
| 6.3V | LMK212 B7 475□G ⁺¹ | RoHS | 4.7 | X7R | 10 | R/W | ±20% | 1.25±0.1 | |
| | JMK212 B7 106□G ⁺¹ | RoHS | 10 | X7R | 10 | R | | 1.25±0.15 | |

[Temp.char. F: F/Y5V]

| Rated Voltage | Ordering code | EHS (Environmental Hazardous Substances) | Capacitance (μF) | Temperature characteristics | Dissipation factor (%) Max. | Soldering method R:Reflow soldering W:Wave soldering | Capacitance tolerance | Thickness (mm) |
|---------------|---------------|--|------------------|-----------------------------|-----------------------------|--|-----------------------|----------------|
| 50V | UMK212 F224ZD | RoHS | 0.22 | F/Y5V | 7 | R/W | +80% -20% | 0.85±0.1 |
| | UMK212 F474ZG | RoHS | 0.47 | F/Y5V | 7 | | | 1.25±0.1 |
| | UMK212 F105ZG | RoHS | 1 | F/Y5V | 7 | | | 1.25±0.1 |
| 16V | EMK212 F225ZG | RoHS | 2.2 | F/Y5V | 7 | R | +80% -20% | 1.25±0.1 |
| 10V | LMK212 F225ZD | RoHS | 2.2 | F/Y5V | 9 | | | 0.85±0.1 |
| | LMK212 F475ZG | RoHS | 4.7 | F/Y5V | 9 | | | 1.25±0.1 |
| | LMK212 F106ZG | RoHS | 10 | F/Y5V | 16 | 1.25±0.1 | | |
| 6.3V | JMK212 F475ZD | RoHS | 4.7 | F/Y5V | 16 | R | +80% -20% | 0.85±0.1 |
| | JMK212 F106ZG | RoHS | 10 | F/Y5V | 16 | | | 1.25±0.1 |

□ Please specify the capacitance tolerance code. *1 1.5 times the rated voltage is applied to the chip during the high temperature loading test. *2 We may provide X7R for some items according to the individual specification. *4 "D" is used for the internal code.

* This catalog contains the typical specification only due to the limitation of space. When you consider purchase of our products, please check our specification. For details of each product (characteristics graph, reliability information, precautions for use, and so on), see our Web site (<http://www.ty-top.com/>) or CD catalogs.

PART NUMBERS

316TYPE

[Temp.char. B: B/X5R]

| Rated Voltage | Ordering code | EHS (Environmental Hazardous Substances) | Capacitance (μF) | Temperature characteristics | Dissipation factor (%) Max. | Soldering method R: Reflow soldering W: Wave soldering | Capacitance tolerance | Thickness (mm) |
|----------------|--------------------------------|--|------------------|-----------------------------|-----------------------------|--|-----------------------|----------------|
| 50V | UMK316 BJ105□D* ¹ | RoHS | 1 | B/X5R | 3.5 | R | ±10% ±20% | 0.85±0.1 |
| | UMK316 BJ225□D* ¹ | RoHS | 2.2 | B/X5R | 3.5 | | | 0.85±0.1 |
| | UMK316 BJ105□L | RoHS | 1 | B/X5R* ² | 3.5 | | | 1.6±0.2 |
| | UMK316 BJ475□L* ¹ | RoHS | 4.7 | X5R | 10 | | | 1.6±0.2 |
| 25V | TMK316 BJ105□D | RoHS | 1 | B/X5R | 3.5 | | | 0.85±0.1 |
| | TMK316 BJ225□D* ¹ | RoHS | 2.2 | B/X5R | 3.5 | | | 0.85±0.1 |
| | TMK316 BJ475□D* ¹ | RoHS | 4.7 | X5R | 5 | | | 0.85±0.1 |
| | TMK316 BJ106□D* ¹ | RoHS | 10 | X5R | 10 | | | 0.85±0.1 |
| | TMK316 BJ225□L | RoHS | 2.2 | B/X5R* ² | 3.5 | | | 1.6±0.2 |
| | TMK316 BJ475□L* ¹ | RoHS | 4.7 | B/X5R | 5 | | | 1.6±0.2 |
| | TMK316 BJ106□L* ¹ | RoHS | 10 | X5R* ² | 5 | | | 1.6±0.2 |
| | EMK316 BJ225□D | RoHS | 2.2 | B/X5R | 3.5 | | | 0.85±0.1 |
| 16V | EMK316 BJ475□D | RoHS | 4.7 | X5R | 5 | | | 0.85±0.1 |
| | EMK316 BJ106□D* ¹ | RoHS | 10 | X5R | 10 | | | 0.85±0.1 |
| | EMK316 BJ225□L | RoHS | 2.2 | B/X5R* ² | 3.5 | | | 1.6±0.2 |
| | EMK316 BJ475□L | RoHS | 4.7 | B/X5R | 5 | | | 1.6±0.2 |
| | EMK316 BJ106□L* ¹ | RoHS | 10 | B/X5R* ² | 5 | 1.6±0.2 | | |
| | EMK316 BJ226ML ¹ | RoHS | 22 | B/X5R | 10 | ±20% | 1.6±0.2 | |
| | LМК316 BJ475□D | RoHS | 4.7 | B/X5R | 5 | ±10% | 0.85±0.1 | |
| | LМК316 BJ106□D | RoHS | 10 | B/X5R | 10 | ±20% | 0.85±0.1 | |
| 10V | LМК316 BJ226MD* ¹ | RoHS | 22 | X5R | 10 | ±20% | 0.85±0.1 | |
| | LМК316 BJ106□L | RoHS | 10 | B/X5R* ² | 5 | ±10% | 1.6±0.2 | |
| | LМК316 BJ226ML* ¹ | RoHS | 22 | B/X5R | 10 | ±20% | 1.6±0.2 | |
| | LМК316 BJ476ML* ¹ | RoHS | 47 | X5R | 10 | ±20% | 1.6±0.2 | |
| | 6.3V | JMK316 BJ106□D | RoHS | 10 | B/X5R | 10 | ±10% | 0.85±0.1 |
| | | JMK316 BJ226MD* ¹ | RoHS | 22 | X5R | 10 | ±20% | 0.85±0.1 |
| | | JMK316 BJ476MD* ¹ | RoHS | 47 | X5R | 10 | ±20% | 0.85±0.1 |
| | | JMK316 BJ106□L | RoHS | 10 | B/X5R* ² | 5 | ±10% | 1.6±0.2 |
| JMK316 BJ226□L | | RoHS | 22 | B/X5R | 10 | ±20% | 1.6±0.2 | |
| JMK316 BJ476ML | | RoHS | 47 | X5R | 10 | ±20% | 1.6±0.2 | |
| 4V | JMK316 BJ107ML* ^{1,3} | RoHS | 100 | X5R | 10 | ±20% | 1.6±0.2 | |
| | AMK316 BJ107ML* ¹ | RoHS | 100 | X5R | 10 | ±20% | 1.6±0.2 | |

□ Please specify the capacitance tolerance code.

*1 1.5 times the rated voltage is applied to the chip during the high temperature loading test.

*2 We may provide X7R for some items according to the individual specification.

*3 The exchange of individual specification is necessary depending on the application and circuit condition. Please contact Taiyo Yuden sales channels.

[Temp.char. B7: X7R]

| Rated Voltage | Ordering code | EHS (Environmental Hazardous Substances) | Capacitance (μF) | Temperature characteristics | Dissipation factor (%) Max. | Soldering method R: Reflow soldering W: Wave soldering | Capacitance tolerance | Thickness (mm) |
|---------------|---------------------------------|--|------------------|-----------------------------|-----------------------------|--|-----------------------|----------------|
| 50V | UMK316 B7 224□L | RoHS | 0.22 | X7R | 2.5 | R/W | ±10% ±20% | 1.6±0.2 |
| | UMK316 B7 474□L | RoHS | 0.47 | X7R | 3.5 | | | 1.6±0.2 |
| | UMK316 B7 105□L | RoHS | 1 | X7R | 3.5 | | | 1.6±0.2 |
| 25V | TMK316 B7 105□L | RoHS | 1 | X7R | 3.5 | R | | 1.6±0.2 |
| | TMK316 B7 225□L | RoHS | 2.2 | X7R | 3.5 | | | 1.6±0.2 |
| | TMK316 B7 106□L* ^{1,4} | RoHS | 10 | X7R | 10 | | | 1.6±0.2 |
| | EMK316 B7 225□L | RoHS | 2.2 | X7R | 3.5 | | | 1.6±0.2 |
| 16V | EMK316 B7 106□L* ⁴ | RoHS | 10 | X7R | 10 | R/W | | 1.6±0.2 |
| | EMK316 B7 106□L* ⁴ | RoHS | 10 | X7R | 10 | R | | 1.6±0.2 |
| 10V | LМК316 B7 225□L | RoHS | 2.2 | X7R | 3.5 | R/W | | 1.6±0.2 |
| | LМК316 B7 475□L | RoHS | 4.7 | X7R | 5 | R/W | | 1.6±0.2 |
| | LМК316 B7 106□L* ^{1,4} | RoHS | 10 | X7R | 10 | R | | 1.6±0.2 |
| 6.3V | JMK316 B7 106□L | RoHS | 10 | X7R | 5 | R | | 1.6±0.2 |

□ Please specify the capacitance tolerance code.

*1 1.5 times the rated voltage is applied to the chip during the high temperature loading test.

*4 *D* is used for the internal code.

[Temp.char. F: F/Y5V]

| Rated Voltage | Ordering code | EHS (Environmental Hazardous Substances) | Capacitance (μF) | Temperature characteristics | Dissipation factor (%) Max. | Soldering method R: Reflow soldering W: Wave soldering | Capacitance tolerance | Thickness (mm) |
|---------------|---------------|--|------------------|-----------------------------|-----------------------------|--|-----------------------|----------------|
| 50V | UMK316 F225ZG | RoHS | 2.2 | F/Y5V | 7 | R/W | +80% -20% | 1.25±0.1 |
| 35V | GMK316 F475ZG | RoHS | 4.7 | F/Y5V | 7 | R | | 1.25±0.1 |
| | GMK316 F106ZL | RoHS | 10 | F/Y5V | 9 | | | 1.6±0.2 |
| 25V | TMK316 F106ZL | RoHS | 10 | F/Y5V | 9 | 1.6±0.2 | | |
| 16V | EMK316 F106ZL | RoHS | 10 | F/Y5V | 9 | 1.6±0.2 | | |
| 10V | LМК316 F475ZD | RoHS | 4.7 | F/Y5V | 9 | R | | 0.85±0.1 |
| | LМК316 F226ZL | RoHS | 22 | F/Y5V | 16 | | | 1.6±0.2 |
| 6.3V | JMK316 F106ZD | RoHS | 10 | F/Y5V | 16 | 0.85±0.1 | | |

* This catalog contains the typical specification only due to the limitation of space. When you consider purchase of our products, please check our specification. For details of each product (characteristics graph, reliability information, precautions for use, and so on), see our Web site (<http://www.ty-top.com/>) or CD catalogs.

PART NUMBERS

● 325TYPE

[Temp.char. BJ:B/X5R]

| Rated Voltage | Ordering code | | EHS (Environmental Hazardous Substances) | Capacitance 〔μF〕 | Temperature characteristics | Dissipation factor 〔%〕Max. | Soldering method R:Reflow soldering W:Wave soldering | Capacitance tolerance | Thickness 〔mm〕 |
|---------------|------------------------------|--|---|---------------------|--------------------------------|-------------------------------|---|--------------------------|-------------------|
| 50V | UMK325 BJ475MM ^{*1} | | RoHS | 4.7 | X5R | 5 | R | ±20% | 2.5±0.2 |
| | UMK325 BJ106MM ^{*1} | | RoHS | 10 | X5R | 5 | | | 2.5±0.2 |
| 35V | GMK325 BJ225MN | | RoHS | 2.2 | B/X5R | 3.5 | | | 1.9±0.2 |
| | GMK325 BJ475MN ^{*1} | | RoHS | 4.7 | X5R | 10 | | | 1.9±0.2 |
| | GMK325 BJ106MN ^{*1} | | RoHS | 10 | B/X5R | 5 | | | 1.9±0.2 |
| 25V | TMK325 BJ106MD ^{*1} | | RoHS | 10 | B/X5R | 5 | | | 0.85±0.1 |
| | TMK325 BJ335MN | | RoHS | 3.3 | B/X5R ^{*2} | 3.5 | | | 1.9±0.2 |
| | TMK325 BJ475MN | | RoHS | 4.7 | B/X5R ^{*2} | 3.5 | | | 1.9±0.2 |
| | TMK325 BJ106MN | | RoHS | 10 | B/X5R | 5 | | | 1.9±0.2 |
| | TMK325 BJ106MM ^{*1} | | RoHS | 10 | B/X5R ^{*2} | 3.5 | | | 2.5±0.2 |
| 16V | EMK325 BJ106MD ^{*1} | | RoHS | 10 | B/X5R | 5 | | | 0.85±0.1 |
| | EMK325 BJ226MD ^{*1} | | RoHS | 22 | B/X5R | 10 | | | 0.85±0.1 |
| | EMK325 BJ475MN | | RoHS | 4.7 | B/X5R ^{*2} | 3.5 | | | 1.9±0.2 |
| | EMK325 BJ106MN | | RoHS | 10 | B/X5R | 3.5 | | | 1.9±0.2 |
| | EMK325 BJ226MM ^{*1} | | RoHS | 22 | B/X5R | 5 | | | 2.5±0.2 |
| | EMK325 BJ476MM ^{*1} | | RoHS | 47 | X5R | 10 | | | 2.5±0.2 |
| 10V | LMK325 BJ335MD | | RoHS | 3.3 | B/X5R | 3.5 | | | 0.85±0.1 |
| | LMK325 BJ475MD | | RoHS | 4.7 | B/X5R | 5 | | | 0.85±0.1 |
| | LMK325 BJ106MD ^{*1} | | RoHS | 10 | B/X5R | 5 | | | 0.85±0.1 |
| | LMK325 BJ226MY ^{*1} | | RoHS | 22 | B/X5R | 5 | | | 1.9+0.1/-0.2 |
| | LMK325 BJ106MN | | RoHS | 10 | B/X5R ^{*2} | 3.5 | 1.9±0.2 | | |
| | LMK325 BJ226MM | | RoHS | 22 | B/X5R | 5 | 2.5±0.2 | | |
| | LMK325 BJ476MM ^{*1} | | RoHS | 47 | X5R | 10 | 2.5±0.2 | | |
| | LMK325 BJ107MM ^{*1} | | RoHS | 100 | X5R | 10 | 2.5±0.3 | | |
| 6.3V | JMK325 BJ226MY | | RoHS | 22 | B/X5R | 5 | 1.9+0.1/-0.2 | | |
| | JMK325 BJ107MY ^{*1} | | RoHS | 100 | X5R | 10 | 1.9+0.1/-0.2 | | |
| | JMK325 BJ476MN ^{*1} | | RoHS | 47 | X5R | 10 | 1.9±0.2 | | |
| | JMK325 BJ476MM ^{*1} | | RoHS | 47 | X5R | 10 | 2.5±0.2 | | |
| | JMK325 BJ107MM ^{*1} | | RoHS | 100 | X5R | 10 | 2.5±0.3 | | |

Please specify the capacitance tolerance code.

*1 1.5 times the rated voltage is applied to the chip during the high temperature loading test.

*2 We may provide X7R for some items according to the individual specification.

[Temp.char. B7:X7R]

| Rated Voltage | Ordering code | | EHS (Environmental Hazardous Substances) | Capacitance 〔μF〕 | Temperature characteristics | Dissipation factor 〔%〕Max. | Soldering method R:Reflow soldering W:Wave soldering | Capacitance tolerance | Thickness 〔mm〕 |
|---------------|-------------------------------|--|---|---------------------|--------------------------------|-------------------------------|---|--------------------------|-------------------|
| 25V | TMK325 B7 335MN | | RoHS | 3.3 | X7R | 3.5 | R | ±20% | 1.9±0.2 |
| | TMK325 B7 475MN ^{*1} | | RoHS | 4.7 | X7R | 3.5 | | | 1.9±0.2 |
| 16V | EMK325 B7 475MN | | RoHS | 4.7 | X7R | 3.5 | | | 1.9±0.2 |
| 10V | LMK325 B7 106MN | | RoHS | 10 | X7R | 3.5 | | | 1.9±0.2 |

Please specify the capacitance tolerance code.

*1 1.5 times the rated voltage is applied to the chip during the high temperature loading test.

[Temp.char. F:F/Y5V]

| Rated Voltage | Ordering code | | EHS (Environmental Hazardous Substances) | Capacitance 〔μF〕 | Temperature characteristics | Dissipation factor 〔%〕Max. | Soldering method R:Reflow soldering W:Wave soldering | Capacitance tolerance | Thickness 〔mm〕 |
|---------------|---------------|--|---|---------------------|--------------------------------|-------------------------------|---|--------------------------|-------------------|
| 16V | EMK325 F226ZN | | RoHS | 22 | F/Y5V | 16 | R | +80% -20% | 1.9±0.2 |
| 10V | LMK325 F226ZN | | RoHS | 22 | F/Y5V | 16 | | | 1.9±0.2 |
| 6.3V | JMK325 F476ZN | | RoHS | 47 | F/Y5V | 16 | | | 1.9±0.2 |

* This catalog contains the typical specification only due to the limitation of space. When you consider purchase of our products, please check our specification. For details of each product (characteristics graph, reliability information, precautions for use, and so on), see our Web site (<http://www.ty-top.com/>) or CD catalogs.

● Example of Impedance ESR vs. Frequency characteristics

■ Taiyo Yuden multilayer ceramic capacitor



* This catalog contains the typical specification only due to the limitation of space. When you consider purchase of our products, please check our specification. For details of each product (characteristics graph, reliability information, precautions for use, and so on), see our Web site (<http://www.ty-top.com/>) or CD catalogs.

STANDARD MULTILAYER CERAMIC CAPACITORS (CLASS1:TEMPERATURE COMPENSATING TYPE)



REFLOW

FEATURES

- Improved higher density mounting.
- Monolithic structure provides higher reliability.
- A wide range of capacitance values available in standard case sizes.

APPLICATIONS

- General electronic equipment
- Communication equipment
(cellular phone, wireless applications, etc.)

ORDERING CODE

U M K 1 0 5 C H 1 0 1 J V - F △

1 2 3 4 5 6 7 8 9 10 11

1 Rated voltage (VDC)

| | |
|---|----|
| E | 16 |
| T | 25 |
| U | 50 |

2 Series name

| | |
|---|------------------------------|
| M | Multilayer ceramic capacitor |
|---|------------------------------|

3 End termination

| | |
|---|--------|
| K | Plated |
|---|--------|

4 Dimensions (EIA) L×W (mm)

| | |
|-------------|---------|
| 042 (01005) | 0.4×0.2 |
| 063 (0201) | 0.6×0.3 |
| 105 (0402) | 1.0×0.5 |

5 Temperature characteristics (ppm/°C)

| | | |
|-----------------|------------|--|
| C□ : 0 | CH, CJ, CK | Tolerance H : ±60 J : ±120 K : ±250 |
| R□ : -220 | RH | |
| S□ : -330 | SH, SJ, SK | |
| T□ : -470 | TJ, TK | |
| U□ : -750 | UJ, UK | |
| SL : +350~-1000 | | |

□ = Tolerance

6 Nominal capacitance (pF)

| | |
|---------|-----|
| example | |
| 0R5 | 0.5 |
| 010 | 1 |
| 100 | 10 |

※R=decimal point

7 Capacitance tolerance

| | |
|---|---------|
| C | ±0.25pF |
| D | ±0.5pF |
| F | ±1pF |
| J | ±5% |
| K | ±10% |

8 Thickness (mm)

| | |
|------|-----|
| C | 0.2 |
| P, T | 0.3 |
| V | 0.5 |
| W | 0.5 |

9 Special code

| | |
|---|------------------|
| - | Standard Product |
|---|------------------|

10 Packaging

| | |
|---|---------------------------|
| F | φ178mm Taping (2mm pitch) |
|---|---------------------------|

11 Internal code

| | |
|---|------------------|
| △ | Standard Product |
|---|------------------|

△=Blank space

EXTERNAL DIMENSIONS/STANDARD QUANTITY

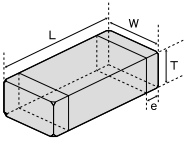

| Type (EIA) | L | W | T | e | Standard quantity [pcs] | | |
|----------------|---------------------------|---------------------------|---------------------------|------|----------------------------|---------------|---|
| | | | | | Paper tape | Embossed tape | |
| □MK042 (01005) | 0.4±0.02 (0.016±0.001) | 0.2±0.02 (0.008±0.001) | 0.2±0.02 (0.008±0.001) | C | 0.1±0.03 (0.004±0.001) | 20000 | - |
| □MK063 (0201) | 0.6±0.03 (0.024±0.001) | 0.3±0.03 (0.012±0.001) | 0.3±0.03 (0.012±0.001) | P, T | 0.15±0.05 (0.006±0.002) | 15000 | - |
| □MK105 (0402) | 1.0±0.05 (0.039±0.002) | 0.5±0.05 (0.020±0.002) | 0.5±0.05 (0.020±0.002) | W, V | 0.25±0.10 (0.010±0.004) | 10000 | - |

Unit : mm (inch)

AVAILABLE CAPACITANCE RANGE

| Cap [pF] | Type | 042 | | | 063 | | | 105 | | | | |
|----------|------------|-----|----|----|-----|----|----|-----|----|----|--|--|
| | Temp.char. | C□ | C□ | U□ | C□ | U□ | SL | R□ | S□ | T□ | | |
| | VDC | 50V | | | | | | | | | | |
| 0.5 | 0R5 | | | | | | | | | | | |
| 1 | 010 | | | | | | | | | | | |
| 1.5 | 1R5 | | | | | | | | | | | |
| 2 | 020 | | | | | | | | | | | |
| 3 | 030 | | | | | | | | | | | |
| 4 | 040 | | | | | | | | | | | |
| 5 | 050 | | | | | | | | | | | |
| 6 | 060 | | | | | | | | | | | |
| 7 | 070 | | | | | | | | | | | |
| 8 | 080 | | | | | | | | | | | |
| 9 | 090 | | | | | | | | | | | |
| 10 | 100 | | | | | | | | | | | |
| 12 | 120 | | | | | | | | | | | |
| 15 | 150 | | | | | | | | | | | |
| 18 | 180 | | | | | | | | | | | |
| 22 | 220 | | | | | | | | | | | |
| 27 | 270 | | | | | | | | | | | |
| 33 | 330 | | | | | | | | | | | |
| 39 | 390 | | | | | | | | | | | |
| 47 | 470 | | | | | | | | | | | |
| 56 | 560 | | | | | | | | | | | |
| 68 | 680 | | | | | | | | | | | |
| 82 | 820 | | | | | | | | | | | |
| 100 | 101 | | | | | | | | | | | |
| 120 | 121 | | | | | | | | | | | |
| 150 | 151 | | | | | | | | | | | |
| 180 | 181 | | | | | | | | | | | |
| 220 | 221 | | | | | | | | | | | |
| 270 | 271 | | | | | | | | | | | |
| 330 | 331 | | | | | | | | | | | |
| 390 | 391 | | | | | | | | | | | |
| 470 | 471 | | | | | | | | | | | |
| 560 | 561 | | | | | | | | | | | |
| 680 | 681 | | | | | | | | | | | |
| 820 | 821 | | | | | | | | | | | |
| 1000 | 102 | | | | | | | | | | | |

Note: Letters in the table indicate thickness.

* This catalog contains the typical specification only due to the limitation of space. When you consider purchase of our products, please check our specification. For details of each product (characteristics graph, reliability information, precautions for use, and so on), see our Web site (<http://www.ty-top.com/>) or CD catalogs.

PART NUMBERS

042TYPE

Class 1

| Rated Voltage | Ordering code | EHS (Environmental Hazardous Substances) | Capacitance [pF] | Temperature characteristics (EIA) | Q | Soldering method R:Reflow soldering W:Wave soldering | Capacitance tolerance | Thickness [mm] (inch) |
|----------------|----------------|---|------------------|-----------------------------------|-----|--|-----------------------|---------------------------|
| 16V | EMK042 CK0R5CC | RoHS | 0.5 | CK | 410 | R | ±0.25pF | 0.2±0.02 (0.008±0.001) |
| | EMK042 CK010CC | RoHS | 1 | | 420 | | | |
| | EMK042 CK1R5CC | RoHS | 1.5 | | 430 | | | |
| | EMK042 CK020CC | RoHS | 2 | CJ | 440 | | | |
| | EMK042 CJ030CC | RoHS | 3 | | 460 | | | |
| | EMK042 CH040CC | RoHS | 4 | CH | 480 | | | |
| | EMK042 CH050CC | RoHS | 5 | | 500 | | | |
| | EMK042 CH060DC | RoHS | 6 | | 520 | | | |
| | EMK042 CH070DC | RoHS | 7 | | 540 | | | |
| | EMK042 CH080DC | RoHS | 8 | | 560 | | | |
| | EMK042 CH090DC | RoHS | 9 | | 580 | | | |
| | EMK042 CH100DC | RoHS | 10 | | 600 | | | |
| | EMK042 CH120JC | RoHS | 12 | | 640 | | | |
| | EMK042 CH150JC | RoHS | 15 | | 700 | | | |
| | EMK042 CH180JC | RoHS | 18 | | 760 | | | |
| | EMK042 CH220JC | RoHS | 22 | 840 | | | | |
| | EMK042 CH270JC | RoHS | 27 | 940 | | | | |
| | EMK042 CH330JC | RoHS | 33 | 1000 | | | | |
| | EMK042 CH390JC | RoHS | 39 | 1000 | | | | |
| | EMK042 CH470JC | RoHS | 47 | 1000 | | | | |
| EMK042 CH560JC | RoHS | 56 | 1000 | | | | | |
| EMK042 CH680JC | RoHS | 68 | 1000 | | | | | |
| EMK042 CH820JC | RoHS | 82 | 1000 | | | | | |
| EMK042 CH101JC | RoHS | 100 | 1000 | | | | | |

Note: "W" is used for the internal code.

Note: Please contact Taiyo Yuden sales channels about items (capacitance, tolerance, and temperature characteristics) other than listed above.

063TYPE

Class1 [C△ characteristic]

| Rated Voltage | Ordering code | EHS (Environmental Hazardous Substances) | Capacitance [pF] | Temperature characteristics (EIA) | Q | Soldering method R:Reflow soldering W:Wave soldering | Capacitance tolerance | Thickness [mm] (inch) |
|----------------|----------------|---|------------------|-----------------------------------|-----|--|-----------------------|---------------------------|
| 50V | UMK063 CK0R5CP | RoHS | 0.5 | CK | 410 | R | ±0.25pF | 0.3±0.03 (0.012±0.001) |
| | UMK063 CK010CP | RoHS | 1 | | 420 | | | |
| | UMK063 CK1R5CP | RoHS | 1.5 | | 430 | | | |
| | UMK063 CK020CP | RoHS | 2 | CJ | 440 | | | |
| | UMK063 CJ030CP | RoHS | 3 | | 460 | | | |
| | UMK063 CH040CP | RoHS | 4 | CH | 480 | | | |
| | UMK063 CH050CP | RoHS | 5 | | 500 | | | |
| | UMK063 CH060DP | RoHS | 6 | | 520 | | | |
| | UMK063 CH070DP | RoHS | 7 | | 540 | | | |
| | UMK063 CH080DT | RoHS | 8 | | 560 | | | |
| | UMK063 CH090DT | RoHS | 9 | | 580 | | | |
| | UMK063 CH100DT | RoHS | 10 | | 600 | | | |
| | UMK063 CH120JT | RoHS | 12 | | 640 | | | |
| | UMK063 CH150JT | RoHS | 15 | | 700 | | | |
| | UMK063 CH180JT | RoHS | 18 | | 760 | | | |
| | UMK063 CH220JT | RoHS | 22 | 840 | | | | |
| | UMK063 CH270JT | RoHS | 27 | 940 | | | | |
| | UMK063 CH330JT | RoHS | 33 | 1000 | | | | |
| | UMK063 CH390JT | RoHS | 39 | 1000 | | | | |
| | UMK063 CH470JT | RoHS | 47 | 1000 | | | | |
| UMK063 CH560JT | RoHS | 56 | 1000 | | | | | |
| UMK063 CH680JT | RoHS | 68 | 1000 | | | | | |
| UMK063 CH820JT | RoHS | 82 | 1000 | | | | | |
| UMK063 CH101JT | RoHS | 100 | 1000 | | | | | |

Note: "G" is used for the special code when the capacitance is less than 8pF.

Note: Please contact Taiyo Yuden sales channels about items (capacitance, tolerance, and temperature characteristics) other than listed above.

Class1 [U△ characteristic]

| Rated Voltage | Ordering code | EHS (Environmental Hazardous Substances) | Capacitance [pF] | Temperature characteristics (EIA) | Q | Soldering method R:Reflow soldering W:Wave soldering | Capacitance tolerance | Thickness [mm] (inch) |
|---------------|----------------|---|------------------|-----------------------------------|-----|--|-----------------------|---------------------------|
| 25V | TMK063 UK0R5CT | RoHS | 0.5 | UK | 410 | R | ±0.25pF | 0.3±0.03 (0.012±0.001) |
| | TMK063 UK010CT | RoHS | 1 | | 420 | | | |
| | TMK063 UK1R5CT | RoHS | 1.5 | | 430 | | | |
| | TMK063 UK020CT | RoHS | 2 | | 440 | | | |
| | TMK063 UK030CT | RoHS | 3 | | 460 | | | |
| | TMK063 UJ040CT | RoHS | 4 | UJ | 480 | | ±0.5pF | |
| | TMK063 UJ050CT | RoHS | 5 | | 500 | | | |
| | TMK063 UJ060DT | RoHS | 6 | | 520 | | | |
| | TMK063 UJ070DT | RoHS | 7 | | 540 | | | |
| | TMK063 UJ080DT | RoHS | 8 | | 560 | | | |
| | TMK063 UJ090DT | RoHS | 9 | | 580 | | | |
| | TMK063 UJ100DT | RoHS | 10 | | 600 | | | |
| | TMK063 UJ120JT | RoHS | 12 | | 640 | | | |
| | TMK063 UJ150JT | RoHS | 15 | | 700 | | | |
| | | | | | | | | |

Note: Please contact Taiyo Yuden sales channels about items (capacitance and tolerance) other than listed above.

* This catalog contains the typical specification only due to the limitation of space. When you consider purchase of our products, please check our specification. For details of each product (characteristics graph, reliability information, precautions for use, and so on), see our Web site (<http://www.ty-top.com/>) or CD catalogs.

PART NUMBERS

105TYPE

Class1 [C△ characteristic]

| Rated Voltage | Ordering code | EHS (Environmental Hazardous Substances) | Capacitance [pF] | Temperature characteristics (EIA) | Q | Soldering method R:Reflow soldering W:Wave soldering | Capacitance tolerance | Thickness [mm] (inch) |
|----------------|----------------|---|------------------|-----------------------------------|------|--|-----------------------|---------------------------|
| 50V | UMK105 CK0R5CW | RoHS | 0.5 | CK | 410 | R | ±0.25pF | 0.5±0.05 (0.020±0.002) |
| | UMK105 CK010CW | RoHS | 1 | | 420 | | | |
| | UMK105 CK1R5CW | RoHS | 1.5 | | 430 | | | |
| | UMK105 CK020CW | RoHS | 2 | | 440 | | | |
| | UMK105 CJ030CW | RoHS | 3 | | CJ | | | |
| | UMK105 CH040CW | RoHS | 4 | CH | 480 | | ±0.5pF | |
| | UMK105 CH050CW | RoHS | 5 | | 500 | | | |
| | UMK105 CH060DW | RoHS | 6 | | 520 | | | |
| | UMK105 CH070DW | RoHS | 7 | | 540 | | | |
| | UMK105 CH080DV | RoHS | 8 | | 560 | | | |
| | UMK105 CH090DV | RoHS | 9 | | 580 | | | |
| | UMK105 CH100DV | RoHS | 10 | | 600 | | | |
| | UMK105 CH120JV | RoHS | 12 | | 640 | | | |
| | UMK105 CH150JV | RoHS | 15 | | 700 | | | |
| | UMK105 CH180JV | RoHS | 18 | | 760 | | | |
| | UMK105 CH220JV | RoHS | 22 | | 840 | | | |
| | UMK105 CH270JV | RoHS | 27 | | 940 | | | |
| | UMK105 CH330JV | RoHS | 33 | | 1000 | | | |
| | UMK105 CH390JV | RoHS | 39 | | 1000 | | | |
| | UMK105 CH470JV | RoHS | 47 | | 1000 | | | |
| | UMK105 CH560JV | RoHS | 56 | | 1000 | | | |
| | UMK105 CH680JV | RoHS | 68 | | 1000 | | | |
| | UMK105 CH820JV | RoHS | 82 | | 1000 | | | |
| | UMK105 CH101JV | RoHS | 100 | | 1000 | | | |
| | UMK105 CH121JV | RoHS | 120 | 1000 | | | | |
| | UMK105 CH151JV | RoHS | 150 | 1000 | | | | |
| UMK105 CH181JV | RoHS | 180 | 1000 | | | | | |
| UMK105 CH221JV | RoHS | 220 | 1000 | | | | | |
| UMK105 CH271JV | RoHS | 270 | 1000 | | | | | |
| UMK105 CH331JV | RoHS | 330 | 1000 | | | | | |

Note: Please contact Taiyo Yuden sales channels about items (capacitance, tolerance, and characteristics) other than listed above.

Class1 [U△ characteristic]

| Rated Voltage | Ordering code | EHS (Environmental Hazardous Substances) | Capacitance [pF] | Temperature characteristics (EIA) | Q | Soldering method R:Reflow soldering W:Wave soldering | Capacitance tolerance | Thickness [mm] (inch) |
|----------------|----------------|---|------------------|-----------------------------------|------|--|-----------------------|---------------------------|
| 50V | UMK105 UK0R5CW | RoHS | 0.5 | UK | 410 | R | ±0.25pF | 0.5±0.05 (0.020±0.002) |
| | UMK105 UK010CW | RoHS | 1 | | 420 | | | |
| | UMK105 UK1R5CW | RoHS | 1.5 | | 430 | | | |
| | UMK105 UK020CW | RoHS | 2 | | 440 | | | |
| | UMK105 UK030CW | RoHS | 3 | | 460 | | | |
| | UMK105 UJ040CW | RoHS | 4 | UJ | 480 | | ±0.5pF | |
| | UMK105 UJ050CW | RoHS | 5 | | 500 | | | |
| | UMK105 UJ060DW | RoHS | 6 | | 520 | | | |
| | UMK105 UJ070DW | RoHS | 7 | | 540 | | | |
| | UMK105 UJ080DW | RoHS | 8 | | 560 | | | |
| | UMK105 UJ090DW | RoHS | 9 | | 580 | | | |
| | UMK105 UJ100DW | RoHS | 10 | | 600 | | | |
| | UMK105 UJ120JW | RoHS | 12 | | 640 | | | |
| | UMK105 UJ150JW | RoHS | 15 | | 700 | | | |
| | UMK105 UJ180JW | RoHS | 18 | | 760 | | | |
| | UMK105 UJ220JV | RoHS | 22 | | 840 | | | |
| | UMK105 UJ270JV | RoHS | 27 | | 940 | | | |
| | UMK105 UJ330JV | RoHS | 33 | | 1000 | | | |
| | UMK105 UJ390JV | RoHS | 39 | | 1000 | | | |
| | UMK105 UJ470JV | RoHS | 47 | | 1000 | | | |
| | UMK105 UJ560JV | RoHS | 56 | | 1000 | | | |
| | UMK105 UJ680JV | RoHS | 68 | | 1000 | | | |
| | UMK105 UJ820JV | RoHS | 82 | | 1000 | | | |
| | UMK105 UJ101JV | RoHS | 100 | | 1000 | | | |
| | UMK105 UJ121JV | RoHS | 120 | 1000 | | | | |
| | UMK105 UJ151JV | RoHS | 150 | 1000 | | | | |
| UMK105 UJ181JV | RoHS | 180 | 1000 | | | | | |
| UMK105 UJ221JV | RoHS | 220 | 1000 | | | | | |
| UMK105 UJ271JV | RoHS | 270 | 1000 | | | | | |
| UMK105 UJ331JV | RoHS | 330 | 1000 | | | | | |

Note: Please contact Taiyo Yuden sales channels about items (capacitance and tolerance) other than listed above.

* This catalog contains the typical specification only due to the limitation of space. When you consider purchase of our products, please check our specification. For details of each product (characteristics graph, reliability information, precautions for use, and so on), see our Web site (<http://www.ty-top.com/>) or CD catalogs.

PART NUMBERS

Class1 [SL characteristic]

| Rated Voltage | Ordering code | EHS (Environmental Hazardous Substances) | Capacitance (pF) | Temperature characteristics (EIA) | Q | Soldering method R:Reflow soldering W:Wave soldering | Capacitance tolerance | Thickness (mm) (inch) |
|---------------|----------------|---|------------------|-----------------------------------|------|--|-----------------------|---------------------------|
| 50V | UMK105 SL121JV | RoHS | 120 | SL | 1000 | R | ±5% | 0.5±0.05 (0.020±0.002) |
| | UMK105 SL151JV | RoHS | 150 | | 1000 | | | |
| | UMK105 SL181JV | RoHS | 180 | | 1000 | | | |
| | UMK105 SL221JV | RoHS | 220 | | 1000 | | | |
| | UMK105 SL271JV | RoHS | 270 | | 1000 | | | |
| | UMK105 SL331JV | RoHS | 330 | | 1000 | | | |

Note: Please contact Taiyo Yuden sales channels about items (capacitance and tolerance) other than listed above.

Class1 [RH characteristic]

| Rated Voltage | Ordering code | EHS (Environmental Hazardous Substances) | Capacitance (pF) | Temperature characteristics (EIA) | Q | Soldering method R:Reflow soldering W:Wave soldering | Capacitance tolerance | Thickness (mm) (inch) |
|---------------|----------------|---|------------------|-----------------------------------|-----|--|-----------------------|---------------------------|
| 50V | UMK105 RH5R6JW | RoHS | 5.6 | RH | 512 | R | ±5% | 0.5±0.05 (0.020±0.002) |
| | UMK105 RH6R8JW | RoHS | 6.8 | | 536 | | | |
| | UMK105 RH8R2JW | RoHS | 8.2 | | 564 | | | |
| | UMK105 RH100JW | RoHS | 10 | | 600 | | | |
| | UMK105 RH120JW | RoHS | 12 | | 640 | | | |
| | UMK105 RH150JW | RoHS | 15 | | 700 | | | |
| | UMK105 RH180JW | RoHS | 18 | | 760 | | | |
| | UMK105 RH200JW | RoHS | 20 | | 800 | | | |

Note: Please contact Taiyo Yuden sales channels about items (capacitance and tolerance) other than listed above.

Class1 [S△ characteristic]

| Rated Voltage | Ordering code | EHS (Environmental Hazardous Substances) | Capacitance (pF) | Temperature characteristics (EIA) | Q | Soldering method R:Reflow soldering W:Wave soldering | Capacitance tolerance | Thickness (mm) (inch) |
|---------------|----------------|---|------------------|-----------------------------------|-----|--|-----------------------|---------------------------|
| 50V | UMK105 SK0R5BW | RoHS | 0.5 | SK | 410 | R | ±0.1pF | 0.5±0.05 (0.020±0.002) |
| | UMK105 SK010BW | RoHS | 1 | | 420 | | | |
| | UMK105 SK1R2BW | RoHS | 1.2 | | 424 | | | |
| | UMK105 SK1R5BW | RoHS | 1.5 | | 430 | | | |
| | UMK105 SK1R8BW | RoHS | 1.8 | | 436 | | | |
| | UMK105 SK2R2JW | RoHS | 2.2 | | 444 | | | |
| | UMK105 SK2R7JW | RoHS | 2.7 | | 454 | | | |
| | UMK105 SJ3R3JW | RoHS | 3.3 | | SJ | | | |
| | UMK105 SJ3R9JW | RoHS | 3.9 | 478 | | | | |
| | UMK105 SH4R7JW | RoHS | 4.7 | SH | 494 | | ±5% | |
| | UMK105 SH5R6JW | RoHS | 5.6 | | 512 | | | |
| | UMK105 SH6R8JW | RoHS | 6.8 | | 536 | | | |
| | UMK105 SH8R2JW | RoHS | 8.2 | | 564 | | | |
| | UMK105 SH100JW | RoHS | 10 | | 600 | | | |
| | UMK105 SH120JW | RoHS | 12 | | 640 | | | |
| | UMK105 SH150JW | RoHS | 15 | | 700 | | | |
| | UMK105 SH180JW | RoHS | 18 | | 760 | | | |
| | UMK105 SH200JW | RoHS | 20 | | 800 | | | |

Note: Please contact Taiyo Yuden sales channels about items (capacitance and tolerance) other than listed above.

Class1 [T△ characteristic]

| Rated Voltage | Ordering code | EHS (Environmental Hazardous Substances) | Capacitance (pF) | Temperature characteristics (EIA) | Q | Soldering method R:Reflow soldering W:Wave soldering | Capacitance tolerance | Thickness (mm) (inch) |
|---------------|----------------|---|------------------|-----------------------------------|-----|--|-----------------------|---------------------------|
| 50V | UMK105 TK0R5BW | RoHS | 0.5 | TK | 410 | R | ±0.1pF | 0.5±0.05 (0.020±0.002) |
| | UMK105 TK010BW | RoHS | 1 | | 420 | | | |
| | UMK105 TK1R2BW | RoHS | 1.2 | | 424 | | | |
| | UMK105 TK1R5BW | RoHS | 1.5 | | 430 | | | |
| | UMK105 TK1R8BW | RoHS | 1.8 | | 436 | | | |
| | UMK105 TK2R2JW | RoHS | 2.2 | | 444 | | | |
| | UMK105 TK2R7JW | RoHS | 2.7 | | 454 | | | |
| | UMK105 TK3R3JW | RoHS | 3.3 | | 466 | | | |
| | UMK105 TK3R9JW | RoHS | 3.9 | TJ | 478 | | | |
| | UMK105 TJ4R7JW | RoHS | 4.7 | | 494 | | | |
| | UMK105 TJ5R6JW | RoHS | 5.6 | TJ | 512 | | ±5% | |
| | UMK105 TJ6R8JW | RoHS | 6.8 | | 536 | | | |
| | UMK105 TJ8R2JW | RoHS | 8.2 | | 564 | | | |
| | UMK105 TJ100JW | RoHS | 10 | | 600 | | | |
| | UMK105 TJ120JW | RoHS | 12 | | 640 | | | |
| | UMK105 TJ150JW | RoHS | 15 | | 700 | | | |
| | UMK105 TJ180JW | RoHS | 18 | | 760 | | | |
| | UMK105 TJ200JW | RoHS | 20 | | 800 | | | |

Note: Please contact Taiyo Yuden sales channels about items (capacitance and tolerance) other than listed above.

* This catalog contains the typical specification only due to the limitation of space. When you consider purchase of our products, please check our specification. For details of each product (characteristics graph, reliability information, precautions for use, and so on), see our Web site (<http://www.ty-top.com/>) or CD catalogs.

PART NUMBERS

●042TYPE(01005 case size)

[Temp.char. BJ:B/X5R]

| Rated Voltage | Ordering code | EHS (Environmental Hazardous Substances) | Capacitance [pF] | Temperature characteristics | Dissipation factor (%) Max. | Soldering method R:Reflow soldering W:Wave soldering | Capacitance tolerance | Thickness [mm] (inch) |
|---------------|------------------|--|------------------|-----------------------------|-----------------------------|--|-----------------------|---------------------------|
| 10V | LMK042 BJ101□C | RoHS | 100 | B/X5R*2 | 5 | R | ±10% ±20% | 0.2±0.02 (0.008±0.001) |
| | LMK042 BJ151□C | RoHS | 150 | | | | | |
| | LMK042 BJ221□C | RoHS | 220 | | | | | |
| | LMK042 BJ331□C | RoHS | 330 | | | | | |
| | LMK042 BJ471□C | RoHS | 470 | | | | | |
| | LMK042 BJ681□C | RoHS | 680 | | | | | |
| | LMK042 BJ102□C | RoHS | 1000 | | | | | |
| | LMK042 BJ152□C*1 | RoHS | 1500 | | | | | |
| | LMK042 BJ222□C*1 | RoHS | 2200 | | | | | |
| | LMK042 BJ332□C*1 | RoHS | 3300 | | | | | |
| 6.3V | LMK042 BJ472□C*1 | RoHS | 4700 | X5R | 10 | R | ±10% ±20% | 0.2±0.02 (0.008±0.001) |
| | LMK042 BJ682□C*1 | RoHS | 6800 | | | | | |
| | LMK042 BJ103□C*1 | RoHS | 10000 | | | | | |
| | JMK042 BJ152□C*1 | RoHS | 1500 | | | | | |
| | JMK042 BJ222□C*1 | RoHS | 2200 | | | | | |
| | JMK042 BJ332□C*1 | RoHS | 3300 | | | | | |
| | JMK042 BJ472□C*1 | RoHS | 4700 | | | | | |
| | JMK042 BJ682□C*1 | RoHS | 6800 | | | | | |
| | JMK042 BJ103□C*1 | RoHS | 10000 | | | | | |

□ Please specify the capacitance tolerance code.
 *1 1.5 times the rated voltage is applied to the chip during the high temperature loading test.
 *2 We may provide X7R/X7S for some items according to the individual specification.
 Note: "W" is used for the internal code.

[Temp.char. B7 : X7R]

| Rated Voltage | Ordering code | EHS (Environmental Hazardous Substances) | Capacitance [pF] | Temperature characteristics | Dissipation factor (%) Max. | Soldering method R:Reflow soldering W:Wave soldering | Capacitance tolerance | Thickness [mm] (inch) |
|-------------------|-------------------|--|------------------|-----------------------------|-----------------------------|--|-----------------------|---------------------------|
| 10V | LMK042 B7 101 □ C | RoHS | 100 | X7R | 5 | R | ±10% ±20% | 0.2±0.02 (0.008±0.001) |
| | LMK042 B7 151 □ C | RoHS | 150 | | | | | |
| | LMK042 B7 221 □ C | RoHS | 220 | | | | | |
| | LMK042 B7 331 □ C | RoHS | 330 | | | | | |
| | LMK042 B7 471 □ C | RoHS | 470 | | | | | |
| | LMK042 B7 681 □ C | RoHS | 680 | | | | | |
| LMK042 B7 102 □ C | RoHS | 1000 | | | | | | |

□ Please specify the capacitance tolerance code.
 Note: "W" is used for the internal code.

●063TYPE(0201 case size)

[Temp.char. BJ:B/X5R]

| Rated Voltage | Ordering code | EHS (Environmental Hazardous Substances) | Capacitance [pF] | Temperature characteristics | Dissipation factor (%) Max. | Soldering method R:Reflow soldering W:Wave soldering | Capacitance tolerance | Thickness [mm] (inch) |
|------------------|------------------|--|------------------|-----------------------------|-----------------------------|--|-----------------------|---------------------------|
| 25V | TMK063 BJ101□P | RoHS | 100 | B/X5R*2 | 3.5 | R | ±10% ±20% | 0.3±0.03 (0.012±0.001) |
| | TMK063 BJ151□P | RoHS | 150 | | | | | |
| | TMK063 BJ221□P | RoHS | 220 | | | | | |
| | TMK063 BJ331□P | RoHS | 330 | | | | | |
| | TMK063 BJ471□P | RoHS | 470 | | | | | |
| | TMK063 BJ681□P | RoHS | 680 | | | | | |
| | TMK063 BJ102□P | RoHS | 1000 | | | | | |
| | TMK063 BJ152□P | RoHS | 1500 | | | | | |
| | TMK063 BJ222□P | RoHS | 2200 | | | | | |
| | TMK063 BJ332□P | RoHS | 3300 | | | | | |
| 16V | TMK063 BJ472□P | RoHS | 4700 | B/X5R | 5 | R | ±10% ±20% | 0.3±0.03 (0.012±0.001) |
| | TMK063 BJ682□P | RoHS | 6800 | | | | | |
| | TMK063 BJ103□P | RoHS | 10000 | | | | | |
| | EMK063 BJ152□P | RoHS | 1500 | | | | | |
| | EMK063 BJ222□P | RoHS | 2200 | | | | | |
| | EMK063 BJ332□P | RoHS | 3300 | | | | | |
| | EMK063 BJ472□P | RoHS | 4700 | | | | | |
| | EMK063 BJ682□P | RoHS | 6800 | | | | | |
| | EMK063 BJ103□P | RoHS | 10000 | | | | | |
| | 10V | LMK063 BJ223□P*1 | RoHS | | | | | |
| LMK063 BJ333□P*1 | | RoHS | 33000 | | | | | |
| LMK063 BJ473□P*1 | | RoHS | 47000 | | | | | |
| LMK063 BJ683□P*1 | | RoHS | 68000 | | | | | |
| LMK063 BJ104□P*1 | | RoHS | 100000 | | | | | |
| 6.3V | LMK063 BJ224MP*1 | RoHS | 220000 | X5R | 10 | R | ±10% ±20% | 0.3±0.03 (0.012±0.001) |
| | JMK063 BJ223□P*1 | RoHS | 22000 | | | | | |
| | JMK063 BJ333□P*1 | RoHS | 33000 | | | | | |
| | JMK063 BJ473□P*1 | RoHS | 47000 | | | | | |
| | JMK063 BJ683□P*1 | RoHS | 68000 | | | | | |
| 6.3V | JMK063 BJ104□P*1 | RoHS | 100000 | X5R | 10 | R | ±10% ±20% | 0.3±0.03 (0.012±0.001) |
| | JMK063 BJ224MP*1 | RoHS | 220000 | | | | | |

To next page

* This catalog contains the typical specification only due to the limitation of space. When you consider purchase of our products, please check our specification.
 For details of each product (characteristics graph, reliability information, precautions for use, and so on), see our Web site (<http://www.ty-top.com/>) or CD catalogs.

PART NUMBERS

| Rated Voltage | Ordering code | EHS (Environmental Hazardous Substances) | Capacitance (pF) | Temperature characteristics | Dissipation factor [%] Max. | Soldering method R:Reflow soldering W:Wave soldering | Capacitance tolerance | Thickness [mm] (inch) |
|---------------|---------------------|--|------------------|-----------------------------|-----------------------------|--|-----------------------|------------------------|
| 4V | AMK063 BJ224MP*1 | RoHS | 220000 | X5R | 10 | R | ±20% | 0.3±0.03 (0.012±0.001) |
| | AMK063 BJ334MP*1,*3 | RoHS | 330000 | | | | | |
| | AMK063 BJ474MP*1,*3 | RoHS | 470000 | | | | | |

□ Please specify the capacitance tolerance code.

*1 1.5 times the rated voltage is applied to the chip during the high temperature loading test.

*2 We may provide X7R for some items according to the individual specification.

*3 The exchange of individual specification is necessary depending on the application and circuit condition. Please contact Taiyo Yuden sales channels.

[Temp.char. B7 : X7R]

| Rated Voltage | Ordering code | EHS (Environmental Hazardous Substances) | Capacitance (pF) | Temperature characteristics | Dissipation factor [%] Max. | Soldering method R:Reflow soldering W:Wave soldering | Capacitance tolerance | Thickness [mm] (inch) |
|---------------|-----------------|--|------------------|-----------------------------|-----------------------------|--|-----------------------|------------------------|
| 25V | TMK063 B7 101□P | RoHS | 100 | X7R | 3.5 | R | ±10% ±20% | 0.3±0.03 (0.012±0.001) |
| | TMK063 B7 151□P | RoHS | 150 | | | | | |
| | TMK063 B7 221□P | RoHS | 220 | | | | | |
| | TMK063 B7 331□P | RoHS | 330 | | | | | |
| | TMK063 B7 471□P | RoHS | 470 | | | | | |
| | TMK063 B7 681□P | RoHS | 680 | | | | | |
| 16V | EMK063 B7 102□P | RoHS | 1000 | | 5 | | | |
| | EMK063 B7 152□P | RoHS | 1500 | | | | | |
| | EMK063 B7 222□P | RoHS | 2200 | | | | | |
| | EMK063 B7 332□P | RoHS | 3300 | | | | | |
| | EMK063 B7 472□P | RoHS | 4700 | | | | | |
| | EMK063 B7 682□P | RoHS | 6800 | | | | | |
| | EMK063 B7 103□P | RoHS | 10000 | | | | | |

□ Please specify the capacitance tolerance code.

● 105TYPE(0402 case size)

[Temp.char. BJ:B/X5R]

| Rated Voltage | Ordering code | EHS (Environmental Hazardous Substances) | Capacitance (pF) | Temperature characteristics | Dissipation factor [%] Max. | Soldering method R:Reflow soldering W:Wave soldering | Capacitance tolerance | Thickness [mm] (inch) |
|---------------|----------------------|--|------------------|-----------------------------|-----------------------------|--|-----------------------|-----------------------|
| 50V | UMK105 BJ 221□V | RoHS | 220 | B/X5R*2 | 2.5 | R | ±10% ±20% | 0.5±0.05 (0.02±0.002) |
| | UMK105 BJ 331□V | RoHS | 330 | | | | | |
| | UMK105 BJ 471□V | RoHS | 470 | | | | | |
| | UMK105 BJ 681□V | RoHS | 680 | | | | | |
| | UMK105 BJ 102□V | RoHS | 1000 | | | | | |
| | UMK105 BJ 152□V | RoHS | 1500 | | | | | |
| | UMK105 BJ 222□V | RoHS | 2200 | | | | | |
| | UMK105 BJ 332□V | RoHS | 3300 | | | | | |
| | UMK105 BJ 472□V | RoHS | 4700 | | | | | |
| | UMK105 BJ 682□V*1 | RoHS | 6800 | | | | | |
| | UMK105 BJ 103□V | RoHS | 10000 | | 3.5 | | | |
| 35V | GMK105 BJ 104□V*1 | RoHS | 100000 | B/X5R | 5 | | | |
| 25V | TMK105 BJ 153□V | RoHS | 15000 | B/X5R*2 | 3.5 | R | ±10% ±20% | 0.5±0.05 (0.02±0.002) |
| | TMK105 BJ 223□V | RoHS | 22000 | | | | | |
| | TMK105 BJ 333□V*1 | RoHS | 33000 | | | | | |
| | TMK105 BJ 473□V*1 | RoHS | 47000 | | | | | |
| | TMK105 BJ 104□V*1 | RoHS | 100000 | B/X5R | 5 | | | |
| 16V | EMK105 BJ 153□V | RoHS | 15000 | B/X5R*2 | 3.5 | R | ±10% ±20% | 0.5±0.05 (0.02±0.002) |
| | EMK105 BJ 223□V | RoHS | 22000 | | | | | |
| | EMK105 BJ 333□V | RoHS | 33000 | | | | | |
| | EMK105 BJ 473□V | RoHS | 47000 | | | | | |
| | EMK105 BJ 683□V | RoHS | 68000 | | | | | |
| | EMK105 BJ 104□V*1 | RoHS | 100000 | | | | | |
| | EMK105 BJ 224□V*1 | RoHS | 220000 | | | | | |
| | EMK105 BJ 105□V*1 | RoHS | 1000000 | X5R | 10 | | | |
| 10V | LMK105 BJ 104□V | RoHS | 100000 | B/X5R | 5 | | | |
| | LMK105 BJ 224□V*1 | RoHS | 220000 | | | | | |
| | LMK105 BJ 474□V*1 | RoHS | 470000 | | | | | |
| | LMK105 BJ 105□V*1 | RoHS | 1000000 | | | | | |
| 6.3V | JMK105 BJ 224□V*1 | RoHS | 220000 | B/X5R | 5 | | | |
| | JMK105 BJ 474□V*1 | RoHS | 470000 | | | | | |
| | JMK105 BJ 105□V*1 | RoHS | 1000000 | | | | | |
| | JMK105 BJ 225MV*1 | RoHS | 2200000 | | | | | |
| 4V | AMK105 BJ 335MV*1,*3 | RoHS | 3300000 | X5R | 10 | | ±20% | 0.5±0.1 (0.02±0.004) |
| | AMK105 BJ 475MV*1 | RoHS | 4700000 | | | | | |

□ Please specify the capacitance tolerance code.

*1 1.5 times the rated voltage is applied to the chip during the high temperature loading test.

*2 We may provide X7R for some items according to the individual specification.

*3 The exchange of individual specification is necessary depending on the application and circuit condition. Please contact Taiyo Yuden sales channels.

* This catalog contains the typical specification only due to the limitation of space. When you consider purchase of our products, please check our specification. For details of each product (characteristics graph, reliability information, precautions for use, and so on), see our Web site (<http://www.ty-top.com/>) or CD catalogs.

PART NUMBERS

[Temp.char. B7:X7R]

| Rated Voltage | Ordering code | | EHS (Environmental Hazardous Substances) | Capacitance [pF] | Temperature characteristics | Dissipation factor [%] Max. | Soldering method R:Reflow soldering W:Wave soldering | Capacitance tolerance | Thickness [mm] (inch) | |
|-------------------------------|-------------------------------|------|---|---------------------|--------------------------------|--------------------------------|--|--------------------------|-----------------------------|-----|
| 50V | UMK105 B7 221□V | | RoHS | 220 | X7R | 2.5 | R | ±10% ±20% | 0.5±0.05 (0.02±0.002) | |
| | UMK105 B7 331□V | | RoHS | 330 | | | | | | |
| | UMK105 B7 471□V | | RoHS | 470 | | | | | | |
| | UMK105 B7 681□V | | RoHS | 680 | | | | | | |
| | UMK105 B7 102□V | | RoHS | 1000 | | | | | | |
| | UMK105 B7 152□V | | RoHS | 1500 | | | | | | |
| | UMK105 B7 222□V | | RoHS | 2200 | | | | | | |
| | UMK105 B7 332□V | | RoHS | 3300 | | | | | | |
| | UMK105 B7 472□V* ¹ | | RoHS | 4700 | | | | | | |
| UMK105 B7 682□V* ¹ | | RoHS | 6800 | | | | | | | |
| UMK105 B7 103□V* ¹ | | RoHS | 10000 | | | | | | | |
| 25V | TMK105 B7 152□V | | RoHS | 1500 | | 2.5 | | | | 3.5 |
| | TMK105 B7 222□V | | RoHS | 2200 | | | | | | |
| | TMK105 B7 332□V | | RoHS | 3300 | | | | | | |
| | TMK105 B7 472□V | | RoHS | 4700 | | | | | | |
| | TMK105 B7 682□V | | RoHS | 6800 | | | | | | |
| | TMK105 B7 103□V | | RoHS | 10000 | | | | | | |
| 16V | EMK105 B7 223□V | | RoHS | 22000 | | 3.5 | | | | 5 |
| | EMK105 B7 473□V | | RoHS | 47000 | | | | | | |
| | EMK105 B7 104□V* ¹ | | RoHS | 100000 | | | | | | |
| 10V | LMK105 B7 223□V | | RoHS | 22000 | 3.5 | 5 | | | | |
| | LMK105 B7 473□V | | RoHS | 47000 | | | | | | |
| | LMK105 B7 104□V* ¹ | | RoHS | 100000 | | | | | | |
| 6.3V | JMK105 B7 224□V* ¹ | | RoHS | 220000 | 5 | | | | | |

□ Please specify the capacitance tolerance code.

*1 1.5 times the rated voltage is applied to the chip during the high temperature loading test.

[Temp.char. F:Y5V]

| Rated Voltage | Ordering code | | EHS (Environmental Hazardous Substances) | Capacitance [pF] | Temperature characteristics | Dissipation factor [%] Max. | Soldering method R:Reflow soldering W:Wave soldering | Capacitance tolerance | Thickness [mm] (inch) | |
|---------------|-----------------------------|--|---|---------------------|--------------------------------|--------------------------------|--|--------------------------|-----------------------------|----|
| 50V | UMK105 F103ZV | | RoHS | 10000 | F/Y5V | 5 | R | +80% -20% | 0.5±0.05 (0.02±0.002) | |
| 25V | TMK105 F223ZV | | RoHS | 22000 | | | | | | |
| 16V | EMK105 F473ZV | | RoHS | 47000 | | | | | | |
| | EMK105 F104ZV | | RoHS | 100000 | | | | | | |
| 10V | LMK105 F224ZV | | RoHS | 220000 | | | | | | 11 |
| 6.3V | JMK105 F474ZV | | RoHS | 470000 | | | | | | |
| | JMK105 F105ZV* ¹ | | RoHS | 1000000 | | | | | | 20 |

*1 1.5 times the rated voltage is applied to the chip during the high temperature loading test.

* This catalog contains the typical specification only due to the limitation of space. When you consider purchase of our products, please check our specification. For details of each product (characteristics graph, reliability information, precautions for use, and so on), see our Web site (<http://www.ty-top.com/>) or CD catalogs.

MULTILAYER CERAMIC CAPACITORS FOR HIGH FREQUENCY APPLICATIONS(1GHz+)



REFLOW

FEATURES

- Q value in the high frequency range (1 GHz+) is superior compared to other types of multilayer capacitors.
- The 1005(0402) case size is designed for high density mounting and weight reduction in various applications.

APPLICATIONS

- Suitable for those high frequency applications in which a capacitor with both a high Q-value and small size is required such as portable communications and other wireless applications. VCO, TCXO etc.
- Adjustment of characteristics in high frequency circuit

ORDERING CODE

U V K 1 0 5 R H 4 R 3 J W - F

| | | | | | |
|---|--------------------------------------|---|---|--------------------------------|-----------------------|
| 1 Rated voltage [VDC] | 3 End termination | 5 Temperature characteristics [ppm/°C] | 6 Nominal capacitance [pF] | 7 Capacitance tolerance | 9 Special code |
| E 16 U 50 | K Plated | CH 0±60 RH -220±60 | example 020 2 4R3 4.3 ※R=Decimal point | B ±0.1pF J ±5% | - Standard Product |
| 2 Series name | 4 Dimensions (EIA) (L×W) [mm] | 8 Thickness [mm] | 10 Packaging | | |
| V Multilayer ceramic capacitor for high frequency | 105(0402) 1.0×0.5 | W 0.5 | F φ178mm Taping (2mm pitch) | | |

EXTERNAL DIMENSIONS/STANDARD QUANTITY

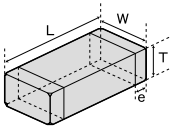

| Type(EIA) | L | W | T | e | Standard quantity [pcs] | |
|---------------|---------------------------|---------------------------|---------------------------|---------------------------|-------------------------|---------------|
| | | | | | Paper tape | Embossed tape |
| □VK105 (0402) | 1.0±0.05 (0.039±0.002) | 0.5±0.05 (0.020±0.002) | 0.5±0.05 (0.020±0.002) | 0.25±0.1 (0.010±0.004) | 10000 | - |

Unit : mm (inch)

SPECIFICATIONS

| Temperature Characteristics | Operating Temperature range | Temperature Coefficient range [ppm/°C] | Capacitance Tolerance |
|-----------------------------|-----------------------------|--|-----------------------|
| CH | -55~+125°C | 0±60 | ±0.1pF (~2.0pF) |
| RH | | -220±60 | ±5% (2.2pF~) |

Capacitance vs Q value (Typical for CH characteristic)

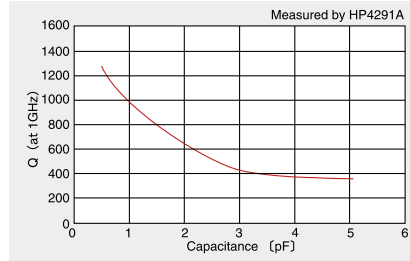

* This catalog contains the typical specification only due to the limitation of space. When you consider purchase of our products, please check our specification. For details of each product (characteristics graph, reliability information, precautions for use, and so on), see our Web site (<http://www.ty-top.com/>) or CD catalogs.

PART NUMBERS

| Rated Voltage (DC) | Ordering code | EHS (Environmental Hazardous Substances) | Temperature characteristics | | Capacitance (pF) | Capacitance tolerance | Q (at 1GHz) (min.) | Thickness [mm] | Typical Q |
|--|--|--|-----------------------------|-----|------------------|-----------------------|--------------------|----------------|-----------|
| | | | CH | RH | | | | | |
| E: 16V U: 50V | <input type="checkbox"/> VK105 CH0R3BW | RoHS | ● | | 0.3 | ±0.1pF | 300 | 0.5±0.05 | 1200 |
| | <input type="checkbox"/> VK105 CH0R4BW | RoHS | ● | | 0.4 | | 300 | | 1200 |
| | <input type="checkbox"/> VK105 CH0R5BW | RoHS | ● | | 0.5 | | 300 | | 1200 |
| | <input type="checkbox"/> VK105 CH0R6BW | RoHS | ● | | 0.6 | | 300 | | 1100 |
| | <input type="checkbox"/> VK105 CH0R7BW | RoHS | ● | | 0.7 | | 300 | | 1100 |
| | <input type="checkbox"/> VK105 CH0R8BW | RoHS | ● | | 0.8 | | 300 | | 1000 |
| | <input type="checkbox"/> VK105 CH0R9BW | RoHS | ● | | 0.9 | | 300 | | 950 |
| | <input type="checkbox"/> VK105 CH010BW | RoHS | ● | | 1.0 | | 300 | | 950 |
| | <input type="checkbox"/> VK105 CH1R1BW | RoHS | ● | | 1.1 | | 280 | | 930 |
| | <input type="checkbox"/> VK105 CH1R2BW | RoHS | ● | | 1.2 | | 270 | | 850 |
| | <input type="checkbox"/> VK105 CH1R3BW | RoHS | ● | | 1.3 | | 260 | | 740 |
| | <input type="checkbox"/> VK105 CH1R5BW | RoHS | ● | | 1.5 | | 240 | | 710 |
| | <input type="checkbox"/> VK105 CH1R6BW | RoHS | ● | | 1.6 | | 230 | | 670 |
| | <input type="checkbox"/> VK105 CH1R8BW | RoHS | ● | | 1.8 | | 210 | | 650 |
| | <input type="checkbox"/> VK105 CH020BW | RoHS | ● | | 2.0 | | 190 | | 610 |
| | <input type="checkbox"/> VK105 CH2R2JW | RoHS | ● | | 2.2 | | 180 | | 530 |
| | <input type="checkbox"/> VK105 CH2R4JW | RoHS | ● | | 2.4 | | 170 | | 510 |
| | <input type="checkbox"/> VK105 CH2R7JW | RoHS | ● | | 2.7 | | 150 | | 460 |
| | <input type="checkbox"/> VK105 CH030JW | RoHS | ● | | 3.0 | | 130 | | 390 |
| | <input type="checkbox"/> VK105 CH3R3JW | RoHS | ● | | 3.3 | | 120 | | 370 |
| | <input type="checkbox"/> VK105 CH3R6JW | RoHS | ● | | 3.6 | 110 | 360 | | |
| | <input type="checkbox"/> VK105 CH3R9JW | RoHS | ● | | 3.9 | 99 | 360 | | |
| | <input type="checkbox"/> VK105 CH4R3JW | RoHS | ● | | 4.3 | 84 | 360 | | |
| | <input type="checkbox"/> VK105 CH4R7JW | RoHS | ● | | 4.7 | 84 | 340 | | |
| | <input type="checkbox"/> VK105 CH5R1JW | RoHS | ● | | 5.1 | 84 | 320 | | |
| | <input type="checkbox"/> VK105 RH0R5BW | RoHS | | ● | 0.5 | 300 | 1100 | | |
| | <input type="checkbox"/> VK105 RH0R6BW | RoHS | | ● | 0.6 | 300 | 1000 | | |
| | <input type="checkbox"/> VK105 RH0R7BW | RoHS | | ● | 0.7 | 300 | 1000 | | |
| | <input type="checkbox"/> VK105 RH0R8BW | RoHS | | ● | 0.8 | 300 | 970 | | |
| | <input type="checkbox"/> VK105 RH0R9BW | RoHS | | ● | 0.9 | 300 | 950 | | |
| | <input type="checkbox"/> VK105 RH010BW | RoHS | | ● | 1.0 | 300 | 900 | | |
| | <input type="checkbox"/> VK105 RH1R1BW | RoHS | | ● | 1.1 | 280 | 900 | | |
| | <input type="checkbox"/> VK105 RH1R2BW | RoHS | | ● | 1.2 | 270 | 740 | | |
| | <input type="checkbox"/> VK105 RH1R3BW | RoHS | | ● | 1.3 | 260 | 700 | | |
| | <input type="checkbox"/> VK105 RH1R5BW | RoHS | | ● | 1.5 | 240 | 680 | | |
| | <input type="checkbox"/> VK105 RH1R6BW | RoHS | | ● | 1.6 | 230 | 640 | | |
| | <input type="checkbox"/> VK105 RH1R8BW | RoHS | | ● | 1.8 | 210 | 620 | | |
| | <input type="checkbox"/> VK105 RH020BW | RoHS | | ● | 2.0 | 190 | 570 | | |
| | <input type="checkbox"/> VK105 RH2R2JW | RoHS | | ● | 2.2 | 180 | 480 | | |
| | <input type="checkbox"/> VK105 RH2R4JW | RoHS | | ● | 2.4 | 170 | 470 | | |
| <input type="checkbox"/> VK105 RH2R7JW | RoHS | | ● | 2.7 | 150 | 420 | | | |
| <input type="checkbox"/> VK105 RH030JW | RoHS | | ● | 3.0 | 130 | 360 | | | |
| <input type="checkbox"/> VK105 RH3R3JW | RoHS | | ● | 3.3 | 120 | 350 | | | |
| <input type="checkbox"/> VK105 RH3R6JW | RoHS | | ● | 3.6 | 110 | 340 | | | |
| <input type="checkbox"/> VK105 RH3R9JW | RoHS | | ● | 3.9 | 99 | 340 | | | |
| <input type="checkbox"/> VK105 RH4R3JW | RoHS | | ● | 4.3 | 84 | 340 | | | |
| <input type="checkbox"/> VK105 RH4R7JW | RoHS | | ● | 4.7 | 84 | 320 | | | |
| <input type="checkbox"/> VK105 RH5R1JW | RoHS | | ● | 5.1 | 84 | 310 | | | |

Please specify the Rated Voltage code.

* This catalog contains the typical specification only due to the limitation of space. When you consider purchase of our products, please check our specification. For details of each product (characteristics graph, reliability information, precautions for use, and so on), see our Web site (<http://www.ty-top.com/>) or CD catalogs.

SUPER LOW DISTORTION MULTILAYER CERAMIC CAPACITORS(CFCAP™)



REFLOW

FEATURES

- Newly developed dielectric material and the use of nickel for internal electrodes provide superior temperature characteristics with high capacitance, small case size and low cost.
- Low distortion and low shock noise make these capacitors appropriate for use in analog or digital mobile devices.
- Superior heat-resistance, high breakdown voltage, and mechanical strength make these capacitors appropriate for replacing film capacitors.

APPLICATIONS

- Signal line for AV products
- Analog signal coupling applications
- PLL circuit of mobile phones
- Good temperature characteristics for time constant circuits, oscillation circuits and filters

ORDERING CODE

T M K 3 1 6 S D 1 0 4 K L - T △

1 Rated voltage [VDC]

| | |
|---|-----|
| U | 50 |
| G | 35 |
| T | 25 |
| E | 16 |
| L | 10 |
| J | 6.3 |

2 Series name

| | |
|---|------------------------------|
| M | Multilayer ceramic capacitor |
|---|------------------------------|

3 End termination

| | |
|---|--------|
| K | Plated |
|---|--------|

4 Dimensions (EIA) (L×W) (mm)

| | |
|------------|----------|
| 105 (0402) | 1.0×0.5 |
| 107 (0603) | 1.6×0.8 |
| 212 (0805) | 2.0×1.25 |
| 316 (1206) | 3.2×1.6 |

5 Series symbol

| | |
|----|----------|
| SD | Standard |
|----|----------|

6 Nominal capacitance [μF]

| | |
|---------|-------|
| example | |
| 223 | 0.022 |
| 104 | 0.1 |

7 Capacitance tolerance

| | |
|---|------|
| K | ±10% |
|---|------|

8 Thickness [mm]

| | |
|---|------|
| P | 0.3 |
| V | 0.5 |
| A | 0.8 |
| D | 0.85 |
| G | 1.15 |
| L | 1.25 |
| L | 1.6 |

9 Special code

| | |
|---|------------------|
| - | Standard Product |
|---|------------------|

10 Packaging

| | |
|---|---|
| T | φ178mm Taping (4mm pitch) 107, 212, 316 Type |
| F | φ178mm Taping (2mm pitch) 105 Type |

11 Internal code

| | |
|---|------------------|
| △ | Standard Product |
|---|------------------|

△=Blank space

EXTERNAL DIMENSIONS/STANDARD QUANTITY

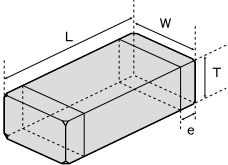

| Type (EIA) | L | W | T | e | Standard quantity [pcs] | |
|---------------|---------------------------|----------------------------|----------------------------|---|-------------------------|---------------|
| | | | | | Paper tape | Embossed tape |
| □MK105 (0402) | 1.0±0.05 (0.039±0.002) | 0.5±0.05 (0.020±0.002) | 0.3±0.03 (0.012±0.001) | 0.25±0.10 (0.010±0.004) | 10000 | - |
| | | | 0.5±0.05 (0.020±0.002) | | | |
| □MK107 (0603) | 1.6±0.10 (0.063±0.004) | 0.8±0.10 (0.031±0.004) | 0.8±0.10 (0.031±0.004) | 0.35±0.25 (0.014±0.010) | 4000 | - |
| | | | 0.85±0.10 (0.033±0.004) | | | |
| □MK212 (0805) | 2.0±0.10 (0.079±0.004) | 1.25±0.10 (0.049±0.004) | 1.25±0.10 (0.049±0.004) | 0.5±0.25 (0.020±0.010) | - | 3000 |
| | | | 1.15±0.10 (0.045±0.004) | | | |
| □MK316 (1206) | 3.2±0.15 (0.126±0.006) | 1.6±0.15 (0.063±0.006) | 1.6±0.20 (0.063±0.008) | 0.5 ^{+0.35} _{-0.25} (0.020 ^{+0.014} _{-0.010}) | - | 2000 |
| | | | 1.6±0.20 (0.063±0.008) | | | |

Unit : mm (inch)

AVAILABLE CAPACITANCE RANGE

| Cap [μF] | Type Temp.Char VDC [pF:3digits] | 105 SD | | | | | 107 SD | | | | 212 SD | | | | 316 SD | |
|----------|--|---------|-----|-----|-----|------|--------|-----|-----|-----|--------|-----|-----|-----|--------|-----|
| | | 50V | 25V | 16V | 10V | 6.3V | 50V | 25V | 16V | 10V | 50V | 35V | 16V | 10V | 35V | 25V |
| | | 0.00039 | 391 | V | | | | | | | | | | | | |
| 0.00047 | 471 | V | | | | | | | | | | | | | | |
| 0.00056 | 561 | V | | | | | | | | | | | | | | |
| 0.00068 | 681 | | V | | | | | | | | | | | | | |
| 0.00082 | 821 | | V | | | | | | | | | | | | | |
| 0.001 | 102 | | V | | | | A | | | | | | | | | |
| 0.0012 | 122 | | V | | | | A | | | | | | | | | |
| 0.0015 | 152 | | | V | P | | A | | | | | | | | | |
| 0.0018 | 182 | | | V | | | A | | | | | | | | | |
| 0.0022 | 222 | | | V | | | A | | | | | | | | | |
| 0.0027 | 272 | | | V | | P | A | | | | | | | | | |
| 0.0033 | 332 | | | | V | | A | | | | | | | | | |
| 0.0039 | 392 | | | | V | | | A | | | D | | | | | |
| 0.0047 | 472 | | | | V | | | A | | | D | | | | | |
| 0.0056 | 562 | | | | | | | | A | | D | | | | | |
| 0.0068 | 682 | | | | | | | | A | | D | | | | | |
| 0.0082 | 822 | | | | | | | | A | | D | | | | | |
| 0.01 | 103 | | | | | | | | A | | D | | | | | |
| 0.012 | 123 | | | | | | | | | A | | D | | | | |
| 0.015 | 153 | | | | | | | | | A | | D | | | | |
| 0.018 | 183 | | | | | | | | | A | | G | | | | |
| 0.022 | 223 | | | | | | | | | A | | G | | | | |
| 0.027 | 273 | | | | | | | | | | G | | | | | |
| 0.033 | 333 | | | | | | | | | | | G | | | | |
| 0.039 | 393 | | | | | | | | | | | | D | | F | |
| 0.047 | 473 | | | | | | | | | | | | | | F | F |
| 0.056 | 563 | | | | | | | | | | | | | | F | F |
| 0.068 | 683 | | | | | | | | | | | | | | G | F |
| 0.082 | 823 | | | | | | | | | | | | | | G | L |
| 0.1 | 104 | | | | | | | | | | | | | | G | L |

※Letters in the table indicate thickness.

* This catalog contains the typical specification only due to the limitation of space. When you consider purchase of our products, please check our specification. For details of each product (characteristics graph, reliability information, precautions for use, and so on), see our Web site (<http://www.ty-top.com/>) or CD catalogs.

PART NUMBERS

● 105TYPE (0402 case size)

| Rated Voltage | Ordering code | EHS (Environmental Hazardous Substances) | Capacitance [μF] | Temperature characteristics | Dissipation factor [%] Max. | Soldering method R:Reflow soldering W:Wave soldering | Capacitance tolerance | Thickness [mm] (inch) |
|---------------|----------------|---|---------------------|--------------------------------|--------------------------------|--|--------------------------|-----------------------------|
| 50V | UMK105 SD391KV | RoHS | 0.00039 | Standard type | 0.1 | R | ±10%* | 0.5±0.05 (0.020±0.002) |
| | UMK105 SD471KV | RoHS | 0.00047 | | | | | |
| | UMK105 SD561KV | RoHS | 0.00056 | | | | | |
| 25V | TMK105 SD681KV | RoHS | 0.00068 | | | | | |
| | TMK105 SD821KV | RoHS | 0.00082 | | | | | |
| | TMK105 SD102KV | RoHS | 0.0010 | | | | | |
| 16V | TMK105 SD122KV | RoHS | 0.0012 | | | | | |
| | EMK105 SD152KV | RoHS | 0.0015 | | | | | |
| | EMK105 SD182KV | RoHS | 0.0018 | | | | | |
| | EMK105 SD222KV | RoHS | 0.0022 | | | | | |
| 10V | EMK105 SD272KV | RoHS | 0.0027 | | | | | |
| | LМК105 SD152KP | RoHS | 0.0015 | | | | | |
| | LМК105 SD332KV | RoHS | 0.0033 | | | | | |
| | LМК105 SD392KV | RoHS | 0.0039 | | | | | |
| 6.3V | LМК105 SD472KV | RoHS | 0.0047 | | | | | |
| | JMK105 SD272KP | RoHS | 0.0027 | | | | | |

*: Capacitance tolerance J (±5%) is also available. Please contact Taiyo Yuden sales channels.

● 107TYPE (0603 case size)

| Rated Voltage | Ordering code | EHS (Environmental Hazardous Substances) | Capacitance [μF] | Temperature characteristics | Dissipation factor [%] Max. | Soldering method R:Reflow soldering W:Wave soldering | Capacitance tolerance | Thickness [mm] (inch) |
|---------------|----------------|---|---------------------|--------------------------------|--------------------------------|--|--------------------------|-----------------------------|
| 50V | UMK107 SD102KA | RoHS | 0.0010 | Standard type | 0.1 | R | ±10%* | 0.8±0.1 (0.031±0.004) |
| | UMK107 SD122KA | RoHS | 0.0012 | | | | | |
| | UMK107 SD152KA | RoHS | 0.0015 | | | | | |
| | UMK107 SD182KA | RoHS | 0.0018 | | | | | |
| | UMK107 SD222KA | RoHS | 0.0022 | | | | | |
| | UMK107 SD272KA | RoHS | 0.0027 | | | | | |
| 25V | UMK107 SD332KA | RoHS | 0.0033 | | | | | |
| | TMK107 SD392KA | RoHS | 0.0039 | | | | | |
| 16V | TMK107 SD472KA | RoHS | 0.0047 | | | | | |
| | EMK107 SD562KA | RoHS | 0.0056 | | | | | |
| | EMK107 SD682KA | RoHS | 0.0068 | | | | | |
| | EMK107 SD822KA | RoHS | 0.0082 | | | | | |
| 10V | EMK107 SD103KA | RoHS | 0.010 | | | | | |
| | LМК107 SD123KA | RoHS | 0.012 | | | | | |
| | LМК107 SD153KA | RoHS | 0.015 | | | | | |
| | LМК107 SD183KA | RoHS | 0.018 | | | | | |
| | LМК107 SD223KA | RoHS | 0.022 | | | | | |

*: Capacitance tolerance J (±5%) is also available. Please contact Taiyo Yuden sales channels.

● 212TYPE (0805 case size)

| Rated Voltage | Ordering code | EHS (Environmental Hazardous Substances) | Capacitance [μF] | Temperature characteristics | Dissipation factor [%] Max. | Soldering method R:Reflow soldering W:Wave soldering | Capacitance tolerance | Thickness [mm] (inch) |
|---------------|----------------|---|---------------------|--------------------------------|--------------------------------|--|--------------------------|-----------------------------|
| 50V | UMK212 SD392KD | RoHS | 0.0039 | Standard type | 0.1 | R | ±10%* | 0.85±0.1 (0.033±0.004) |
| | UMK212 SD472KD | RoHS | 0.0047 | | | | | |
| | UMK212 SD562KD | RoHS | 0.0056 | | | | | |
| | UMK212 SD682KD | RoHS | 0.0068 | | | | | |
| | UMK212 SD822KD | RoHS | 0.0082 | | | | | |
| 35V | UMK212 SD103KD | RoHS | 0.01 | | | | | |
| | GМК212 SD123KD | RoHS | 0.012 | | | | | |
| | GМК212 SD153KD | RoHS | 0.015 | | | | | |
| | GМК212 SD183KG | RoHS | 0.018 | | | | | |
| | GМК212 SD223KG | RoHS | 0.022 | | | | | |
| | GМК212 SD273KG | RoHS | 0.027 | | | | | |
| 16V | GМК212 SD333KD | RoHS | 0.033 | | | | | |
| 10V | EMK212 SD333KD | RoHS | 0.033 | | | | | |
| | LМК212 SD473KD | RoHS | 0.047 | | | | | |
| | LМК212 SD683KG | RoHS | 0.068 | | | | | |
| | LМК212 SD823KG | RoHS | 0.082 | | | | | |
| | LМК212 SD104KG | RoHS | 0.1 | | | | | |

*: Capacitance tolerance J (±5%) is also available. Please contact Taiyo Yuden sales channels.

● 316TYPE (1206 case size)

| Rated Voltage | Ordering code | EHS (Environmental Hazardous Substances) | Capacitance [μF] | Temperature characteristics | Dissipation factor [%] Max. | Soldering method R:Reflow soldering W:Wave soldering | Capacitance tolerance | Thickness [mm] (inch) |
|---------------|----------------|---|---------------------|--------------------------------|--------------------------------|--|--------------------------|-----------------------------|
| 35V | GМК316 SD333KF | RoHS | 0.033 | Standard type | 0.1 | R | ±10%* | 1.15±0.1 (0.045±0.004) |
| | GМК316 SD393KF | RoHS | 0.039 | | | | | |
| 25V | TMK316 SD473KF | RoHS | 0.047 | | | | | |
| | TMK316 SD563KF | RoHS | 0.056 | | | | | |
| | TMK316 SD683KF | RoHS | 0.068 | | | | | |
| | TMK316 SD823KL | RoHS | 0.082 | | | | | |
| | TMK316 SD104KL | RoHS | 0.1 | | | | | |

*: Capacitance tolerance J (±5%) is also available. Please contact Taiyo Yuden sales channels.

* This catalog contains the typical specification only due to the limitation of space. When you consider purchase of our products, please check our specification. For details of each product (characteristics graph, reliability information, precautions for use, and so on), see our Web site (<http://www.ty-top.com/>) or CD catalogs.

Capacitance-temperature characteristics

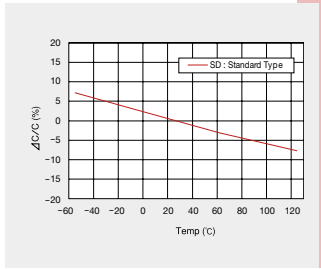

* This catalog contains the typical specification only due to the limitation of space. When you consider purchase of our products, please check our specification. For details of each product (characteristics graph, reliability information, precautions for use, and so on), see our Web site (<http://www.ty-top.com/>) or CD catalogs.

Multilayer Ceramic Capacitors and Medium-High Voltage Multilayer Ceramic Capacitors are noted separately.

Super Low Distortion Multilayer Ceramic Capacitors (CFCAP)

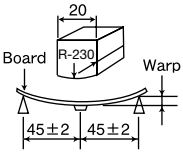
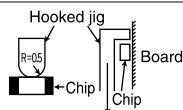
| 1. Operating Temperature Range | | | | | | | | | | | | |
|--|--|--------------------|-------------|--------------------|----------|-----------------|--------------|---------|----------|------------------|----------------|---------|
| Specified Value | -55 to +125°C | | | | | | | | | | | |
| 2. Storage Temperature Range | | | | | | | | | | | | |
| Specified Value | -55 to +125°C | | | | | | | | | | | |
| 3. Rated Voltage | | | | | | | | | | | | |
| Specified Value | 6.3VDC, 10VDC, 16VDC, 25VDC, 35VDC, 50VDC | | | | | | | | | | | |
| 4. Withstanding Voltage (Between terminals) | | | | | | | | | | | | |
| Specified Value | No breakdown or damage | | | | | | | | | | | |
| [Test Methods and Remarks] Applied voltage: Rated voltage×3 Duration: 1 to 5 sec. Charge/discharge current: 50mA max. | | | | | | | | | | | | |
| 5. Insulation Resistance | | | | | | | | | | | | |
| Specified Value | 10000 MΩ or 500MΩ μF, whichever is smaller | | | | | | | | | | | |
| [Test Methods and Remarks] Applied voltage: Rated voltage Duration: 60±5 sec. Charge/discharge current: 50mA max. | | | | | | | | | | | | |
| 6. Capacitance (Tolerance) | | | | | | | | | | | | |
| Specified Value | ±10% | | | | | | | | | | | |
| [Test Methods and Remarks] Measuring frequency : 1kHz±10% Measuring voltage : 1±0.2Vrms Bias application: None | | | | | | | | | | | | |
| 7. Dissipation Factor | | | | | | | | | | | | |
| Specified Value | 0.1%max | | | | | | | | | | | |
| [Test Methods and Remarks] Measuring frequency : 1kHz±10% Measuring voltage : 1±0.2Vrms Bias application: None | | | | | | | | | | | | |
| 8. Deflection | | | | | | | | | | | | |
| Specified Value | Appearance: No abnormality Capacitance change: ±5% | | | | | | | | | | | |
| [Test Methods and Remarks] Warp: 1mm Speed: 0.5mm/second Duration: 10 seconds Test board: glass epoxy resin substrate Thickness: 1.6mm Capacitance measurement shall be conducted with the board bent. | | | | | | | | | | | | |
|  <p>(Unit: mm)</p> | | | | | | | | | | | | |
| 9. Adhesive Strength of Terminal Electrodes | | | | | | | | | | | | |
| Specified Value | No terminal separation or its indication. | | | | | | | | | | | |
| [Test Methods and Remarks] Applied force: 5N Duration: 30 ±5 seconds | | | | | | | | | | | | |
|  | | | | | | | | | | | | |
| 10. Solderability | | | | | | | | | | | | |
| Specified Value | At least 95% of terminal electrode is covered by new solder. | | | | | | | | | | | |
| [Test Methods and Remarks] | | | | | | | | | | | | |
| | <table border="1"> <thead> <tr> <th></th> <th>Solder type</th> <th>Solder temperature</th> <th>Duration</th> </tr> </thead> <tbody> <tr> <td>Eutectic solder</td> <td>H60A or H63A</td> <td>230±5°C</td> <td rowspan="2">4±1 sec.</td> </tr> <tr> <td>Lead-free solder</td> <td>Sn-3.0Ag-0.5Cu</td> <td>245±3°C</td> </tr> </tbody> </table> | | Solder type | Solder temperature | Duration | Eutectic solder | H60A or H63A | 230±5°C | 4±1 sec. | Lead-free solder | Sn-3.0Ag-0.5Cu | 245±3°C |
| | Solder type | Solder temperature | Duration | | | | | | | | | |
| Eutectic solder | H60A or H63A | 230±5°C | 4±1 sec. | | | | | | | | | |
| Lead-free solder | Sn-3.0Ag-0.5Cu | 245±3°C | | | | | | | | | | |
| 11. Resistance to Soldering | | | | | | | | | | | | |
| Specified Value | Appearance: No abnormality Capacitance change: ±2.5% max. Dissipation factor : Initial value Insulation resistance: Initial value Withstanding voltage (between terminals): No abnormality | | | | | | | | | | | |
| [Test Methods and Remarks] Solder temp.: 270 ±5°C Duration: 3 ±0.5 sec. Preheating conditions : 80 to 100°C, 2 to 5 min. or 5 to 10 min. 150 to 200°C, 2 to 5 min. or 5 to 10 min. Recovery : 24±2hrs under the standard condition Note1 | | | | | | | | | | | | |

* This catalog contains the typical specification only due to the limitation of space. When you consider purchase of our products, please check our specification. For details of each product (characteristics graph, reliability information, precautions for use, and so on), see our Web site (<http://www.ty-top.com/>) or CD catalogs.

RELIABILITY DATA

12. Temperature Cycle (Thermal Shock)

| | |
|-----------------|--|
| Specified Value | Appearance: No abnormality Capacitance change: $\pm 2.5\%$ max Dissipation factor : Initial value Insulation resistance: Initial value Withstanding voltage (between terminals) : No abnormality |
|-----------------|--|

[Test Methods and Remarks]

Conditions for 1 cycle / Step 1: Minimum operating temperature $\pm 0_{-3}^{\circ}\text{C}$ 30 \pm 3 min.
Step 2: Room temperature 2 to 3 min.
Step 3: Maximum operating temperature $\pm 0_{-3}^{\circ}\text{C}$ 30 \pm 3 min.
Step 4: Room temperature 2 to 3 min.

Number of cycles: 5 times

Recovery : 24 \pm 2hrs under the standard condition Note1

13. Humidity (Steady state)

| | |
|-----------------|---|
| Specified Value | Appearance: No abnormality Capacitance change: $\pm 5\%$ max Dissipation factor : 0.5% max Insulation resistance 50M Ω μ F or 1000M Ω , whichever is smaller |
|-----------------|---|

[Test Methods and Remarks]

Temperature: 40 \pm 2 $^{\circ}\text{C}$

Humidity: 90 to 95% RH

Duration: 500 $^{+24}_{-0}$ hrs

Recovery: 24 \pm 2hrs under the standard condition Note1

14. Humidity Loading

| | |
|-----------------|---|
| Specified Value | Appearance: No abnormality Capacitance change: $\pm 7.5\%$ max Dissipation factor : 0.5% max Insulation resistance: 25M Ω μ F or 500M Ω , whichever is smaller |
|-----------------|---|

[Test Methods and Remarks]

According to JIS C 5102 clause 9.9.

Temperature: 40 \pm 2 $^{\circ}\text{C}$ Humidity: 90 to 95% RH

Duration: 500 $^{+24}_{-0}$ hrs

Applied voltage: Rated voltage

Charge/discharge current: 50mA max

Recovery: 24 \pm 2hrs under the standard condition Note1

15. High Temperature Loading

| | |
|-----------------|---|
| Specified Value | Appearance: No abnormality Capacitance change: $\pm 3\%$ max Dissipation factor : 0.35% max Insulation resistance: 50M Ω μ F or 1000M Ω , whichever is smaller |
|-----------------|---|

[Test Methods and Remarks]

According to JIS C 5102 clause 9.10.

Temperature: 125 \pm 3 $^{\circ}\text{C}$

Duration: 1000 $^{+48}_{-0}$ hrs

Applied voltage: Rated voltage x 2

Charge/discharge current: 50mA max

Recovery: 24 \pm 2hrs under the standard condition Note1

Note1 Standard condition: Temperature: 5 to 35 $^{\circ}\text{C}$, Relative humidity: 45 to 85 % RH, Air pressure: 86 to 106kPa

When there are questions concerning measurement results, in order to provide correlation data, the test shall be conducted under the following condition.

Temperature: 20 \pm 2 $^{\circ}\text{C}$, Relative humidity: 60 to 70 % RH, Air pressure: 86 to 106kPa

Unless otherwise specified, all the tests are conducted under the "standard condition".

* This catalog contains the typical specification only due to the limitation of space. When you consider purchase of our products, please check our specification.
For details of each product (characteristics graph, reliability information, precautions for use, and so on), see our Web site (<http://www.ty-top.com/>) or CD catalogs.

MEDIUM-HIGH VOLTAGE MULTILAYER CERAMIC CAPACITORS



REFLOW

FEATURES

- The use of nickel as electrode material prevents migration and provides high reliability.
- Small case sizes with high rated voltage.

APPLICATIONS

- General telephone exchange
- Inverter
- Wireless and Telecommunication base
- For DC/DC Converter

ORDERING CODE

H M K 3 1 6 B J 1 0 4 K L - T \triangle

1

| 1 Rated voltage (VDC) | |
|-----------------------|-----|
| H | 100 |
| Q | 250 |
| S | 630 |

2

| 2 Series name | |
|---------------|------------------------------|
| M | Multilayer ceramic capacitor |

3

| 3 End termination | |
|-------------------|--------|
| K | Plated |

4

| 4 Dimensions (EIA) L×W (mm) | |
|-----------------------------|----------|
| 107 (0603) | 1.6×0.8 |
| 212 (0805) | 2.0×1.25 |
| 316 (1206) | 3.2×1.6 |
| 325 (1210) | 3.2×2.5 |
| 432 (1812) | 4.5×3.2 |

5

| 5 Temperature characteristics code | |
|------------------------------------|-----|
| BJ | B |
| | X5R |
| B7 | X7R |
| C7 | X7S |

6

| 6 Nominal capacitance (pF) | |
|----------------------------|-----------|
| example | |
| 104 | 100,000 |
| 105 | 1,000,000 |

7

| 7 Capacitance tolerance | |
|-------------------------|------|
| K | ±10% |
| M | ±20% |

8

| 8 Thickness (mm) | |
|------------------|------|
| A | 0.8 |
| D | 0.85 |
| G | 1.25 |
| F | 1.15 |
| L | 1.6 |
| N | 1.9 |
| M | 2.5 |

9

| 9 Special code | |
|----------------|------------------|
| - | Standard Product |

10

| 10 Packaging | |
|--------------|---------------------------|
| T | φ178mm Taping (4mm pitch) |

11

| 11 Internal code | |
|------------------|------------------|
| \triangle | Standard Product |

\triangle =Blank space

EXTERNAL DIMENSIONS/STANDARD QUANTITY

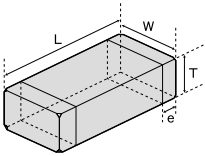

| Type (EIA) | L | W | T | e | Standard quantity [pcs] | | |
|---------------|---------------------------|----------------------------|----------------------------|---|---|---------------------------|------|
| | | | | | Paper tape | Embossed tape | |
| □MK107 (0603) | 1.6±0.10 (0.063±0.004) | 0.8±0.10 (0.031±0.004) | 0.8±0.10 (0.031±0.004) | A | 0.35±0.25 (0.014±0.010) | 4000 | - |
| | | | 0.85±0.10 (0.033±0.004) | D | 0.5±0.25 (0.020±0.010) | 4000 | - |
| □MK212 (0805) | 2.0±0.10 (0.079±0.004) | 1.25±0.10 (0.049±0.004) | 1.25±0.10 (0.049±0.004) | G | | 0.5±0.25 (0.020±0.010) | - |
| | | | 1.15±0.10 (0.045±0.004) | F | - | | 3000 |
| □MK316 (1206) | 3.2±0.15 (0.126±0.006) | 1.6±0.15 (0.063±0.006) | 1.6±0.20 (0.063±0.008) | L | 0.5 ^{+0.35} _{-0.25} (0.020 ^{+0.014} _{-0.010}) | - | 2000 |
| | | | 1.15±0.10 (0.045±0.004) | F | | - | 2000 |
| □MK325 (1210) | 3.2±0.3 (0.126±0.012) | 2.5±0.20 (0.098±0.008) | 1.9±0.20 (0.075±0.008) | N | 0.6±0.3 (0.024±0.012) | - | 2000 |
| | | | 1.15±0.10 (0.045±0.004) | F | | - | 2000 |
| □MK432 (1812) | 4.5±0.4 (0.177±0.016) | 3.2±0.30 (0.126±0.012) | 2.5±0.20 (0.098±0.008) | M | 0.9±0.6 (0.035±0.024) | - | 500 |

Unit : mm (inch)

AVAILABLE CAPACITANCE RANGE

| Cap [μF] | Type Temp. Char VDC | 107 | | | 212 | | | | 316 | | | | | | 325 | | | | | | 432 | | | | | | | | | | | | |
|----------|---------------------------|------|------|-------|------|-------|------|-------|------|-------|------|-------|------|-------|------|-------|------|-------|------|-------|------|------|------|---|---|---|--|---|---|--|---|---|--|
| | | X7R | X7S | B/X5R | X7R | B/X5R | X7R | B/X5R | X7R | B/X5R | X7R | B/X5R | X7R | B/X5R | X7R | B/X5R | X7R | B/X5R | X7R | B/X5R | | | | | | | | | | | | | |
| | | 100V | 100V | 100V | 100V | 250V | 100V | 250V | 100V | 250V | 630V | 100V | 250V | 630V | 100V | 250V | 630V | 100V | 250V | 630V | 100V | 250V | 630V | | | | | | | | | | |
| 0.001 | 102 | A | | A | | D | | D | | | F | | F | | | | | | | | | | | | | | | | | | | | |
| 0.0015 | 152 | A | | A | | D | | D | | | F | | F | | | | | | | | | | | | | | | | | | | | |
| 0.0022 | 222 | A | | A | | D | | D | | | F | | F | | | | | | | | | | | | | | | | | | | | |
| 0.0033 | 332 | A | | A | | D | | D | | | F | | F | | | | | | | | | | | | | | | | | | | | |
| 0.0047 | 472 | A | | A | | G | | G | | | F | | F | | | | | | | | | | | | | | | | | | | | |
| 0.0068 | 682 | A | | A | | G | | G | | | F | | F | | | | | | | | | | | | | | | | | | | | |
| 0.01 | 103 | A | | A | G | G | G | G | | | F | | F | | | | | | | | | | | | | | | | | | | | |
| 0.015 | 153 | A | | A | G | G | G | G | | | L | | L | | | | | | | | | | | | | | | | | | | | |
| 0.022 | 223 | A | | A | G | G | G | G | | | L | | L | | | | | | | | | | | | | | | | | | | | |
| 0.033 | 333 | A | | A | G | | G | | | | L | | L | | | | | | | | | | | | | | | | | | | | |
| 0.047 | 473 | | | | G | | G | | | L | L | | L | L | | | | | | | | | | | | | | | | | | | |
| 0.068 | 683 | | | | G | | G | | | L | L | | L | L | | | | | | | | | | | | | | | | | | | |
| 0.1 | 104 | | A | A | G | | G | | | L | L | | L | L | | | | | | | F | N | | F | N | | | M | M | | M | M | |
| 0.15 | 154 | | | | | | | | | L | | | L | | | | | | | | | N | N | | N | N | | | | | | | |
| 0.22 | 224 | | | | G | | G | | | L | | | L | | | | | | | | | N | N | | N | N | | | M | | | M | |
| 0.33 | 334 | | | | | | | | | L | | | L | | | | | | | | | N | | | N | | | | M | | | M | |
| 0.47 | 474 | | | | | | | | | L | | | L | | | | | | | | | N | | | N | | | | M | | | M | |
| 0.68 | 684 | | | | | | | | | | | | | | | | | | | | | N | | | N | | | | | | | M | |
| 1.0 | 105 | | | | | | | | | L | | | L | | | | | | | | | | | | N | | | | M | | | M | |
| 1.5 | 155 | | | | | | | | | | | | | | | | | | | | | | | | N | | | | M | | | M | |
| 2.2 | 225 | | | | | | | | | | | | | | | | | | | | | | | | N | | | | M | | | M | |

※Letters in the table indicate thickness.

* This catalog contains the typical specification only due to the limitation of space. When you consider purchase of our products, please check our specification. For details of each product (characteristics graph, reliability information, precautions for use, and so on), see our Web site (<http://www.ty-top.com/>) or CD catalogs.

AVAILABLE CAPACITANCE RANGE

| Temp.char.Code | Temperature characteristics | | | | | Capacitance tolerance (%) |
|----------------|-----------------------------|-----|------------------------|-----------------|------------------------|---------------------------|
| | Applicable standard | | Temperature range (°C) | Ref. Temp. (°C) | Capacitance change (%) | |
| BJ | JIS | B | -25~+85 | 20 | ±10 | ±10 (K) ±20 (M) |
| | EIA | X5R | -55~+85 | 25 | ±15 | |
| B7 | EIA | X7R | -55~+125 | 25 | ±15 | |
| C7 | EIA | X7S | -55~+125 | 25 | ±22 | |

PART NUMBERS

107TYPE(0603 case size)

[Temp.char. BJ:B/X5R]

| Rated Voltage | Ordering code | | EHS (Environmental Hazardous Substances) | Capacitance (μF) | Temperature characteristics | Dissipation factor (%) Max. | Soldering method R:Reflow soldering W:Wave soldering | Capacitance tolerance | Thickness (mm) (inch) |
|----------------|----------------|------|---|---------------------|--------------------------------|--------------------------------|--|--------------------------|-----------------------------|
| 100V | HMK107 BJ102□A | | RoHS | 0.001 | B/X5R*2 | 3.5 | R | ±10% ±20% | 0.8±0.1 (0.031±0.0041) |
| | HMK107 BJ152□A | | RoHS | 0.0015 | | | | | |
| | HMK107 BJ222□A | | RoHS | 0.0022 | | | | | |
| | HMK107 BJ332□A | | RoHS | 0.0033 | | | | | |
| | HMK107 BJ472□A | | RoHS | 0.0047 | | | | | |
| | HMK107 BJ682□A | | RoHS | 0.0068 | | | | | |
| | HMK107 BJ103□A | | RoHS | 0.01 | | | | | |
| | HMK107 BJ153□A | | RoHS | 0.015 | | | | | |
| | HMK107 BJ223□A | | RoHS | 0.022 | | | | | |
| | HMK107 BJ333□A | | RoHS | 0.033 | | | | | |
| HMK107 BJ104□A | | RoHS | 0.1 | | | | | | |

□ Please specify the capacitance tolerance code.

*2 : We may provide X7R/X7S for some items according to the individual specification.

[Temp.char. B7:X7R C7:X7S]

| Rated Voltage | Ordering code | | EHS (Environmental Hazardous Substances) | Capacitance (μF) | Temperature characteristics | Dissipation factor (%) Max. | Soldering method R:Reflow soldering W:Wave soldering | Capacitance tolerance | Thickness (mm) (inch) |
|-----------------|-----------------|------|---|---------------------|--------------------------------|--------------------------------|--|--------------------------|-----------------------------|
| 100V | HMK107 B7 102□A | | RoHS | 0.001 | X7R | 3.5 | R | ±10% ±20% | 0.8±0.1 (0.031±0.0041) |
| | HMK107 B7 152□A | | RoHS | 0.0015 | | | | | |
| | HMK107 B7 222□A | | RoHS | 0.0022 | | | | | |
| | HMK107 B7 332□A | | RoHS | 0.0033 | | | | | |
| | HMK107 B7 472□A | | RoHS | 0.0047 | | | | | |
| | HMK107 B7 682□A | | RoHS | 0.0068 | | | | | |
| | HMK107 B7 103□A | | RoHS | 0.01 | | | | | |
| | HMK107 B7 153□A | | RoHS | 0.015 | | | | | |
| | HMK107 B7 223□A | | RoHS | 0.022 | | | | | |
| | HMK107 B7 333□A | | RoHS | 0.033 | | | | | |
| HMK107 C7 104□A | | RoHS | 0.1 | X7S | | | | | |

□ Please specify the capacitance tolerance code.

212TYPE(0805 case size)

[Temp.char. BJ:B/X5R]

| Rated Voltage | Ordering code | | EHS (Environmental Hazardous Substances) | Capacitance (μF) | Temperature characteristics | Dissipation factor (%) Max. | Soldering method R:Reflow soldering W:Wave soldering | Capacitance tolerance | Thickness (mm) (inch) |
|----------------|----------------|------|---|---------------------|--------------------------------|--------------------------------|--|---------------------------|-----------------------------|
| 100V | HMK212 BJ103□G | | RoHS | 0.01 | B/X5R*2 | 3.5 | R | ±10% ±20% | 1.25±0.1 (0.049±0.004) |
| | HMK212 BJ153□G | | RoHS | 0.015 | | | | | |
| | HMK212 BJ223□G | | RoHS | 0.022 | | | | | |
| | HMK212 BJ333□G | | RoHS | 0.033 | | | | | |
| | HMK212 BJ473□G | | RoHS | 0.047 | | | | | |
| | HMK212 BJ683□G | | RoHS | 0.068 | | | | | |
| | HMK212 BJ104□G | | RoHS | 0.1 | | | | | |
| 250V | HMK212 BJ224□G | | RoHS | 0.22 | | | | | |
| | QMK212 BJ102□D | | RoHS | 0.001 | | 2.5 | R | ±10% ±20% | 0.85±0.1 (0.033±0.004) |
| | QMK212 BJ152□D | | RoHS | 0.0015 | | | | | |
| | QMK212 BJ222□D | | RoHS | 0.0022 | | | | | |
| | QMK212 BJ332□D | | RoHS | 0.0033 | | | | | |
| | QMK212 BJ472□G | | RoHS | 0.0047 | | | | | |
| | QMK212 BJ682□G | | RoHS | 0.0068 | | | | | |
| | QMK212 BJ103□G | | RoHS | 0.01 | | | | | |
| QMK212 BJ153□G | | RoHS | 0.015 | | | | | | |
| QMK212 BJ223□G | | RoHS | 0.022 | | | | | 1.25±0.1 (0.049±0.004) | |

□ Please specify the capacitance tolerance code.

*2 : We may provide X7R for some items according to the individual specification.

* This catalog contains the typical specification only due to the limitation of space. When you consider purchase of our products, please check our specification.
For details of each product (characteristics graph, reliability information, precautions for use, and so on), see our Web site (<http://www.ty-top.com/>) or CD catalogs.

PART NUMBERS

[Temp.char. B7:X7R]

| Rated Voltage | Ordering code | EHS (Environmental Hazardous Substances) | Capacitance (μF) | Temperature characteristics | Dissipation factor [%] Max. | Soldering method R:Reflow soldering W:Wave soldering | Capacitance tolerance | Thickness (mm) (inch) | | | |
|-----------------|-----------------|--|------------------|-----------------------------|-----------------------------|--|-----------------------|------------------------|---|-----------|------------------------|
| 100V | HMK212 B7 103□G | RoHS | 0.01 | X7R | 3.5 | R | ±10% ±20% | 1.25±0.1 (0.049±0.004) | | | |
| | HMK212 B7 153□G | RoHS | 0.015 | | | | | | | | |
| | HMK212 B7 223□G | RoHS | 0.022 | | | | | | | | |
| | HMK212 B7 333□G | RoHS | 0.033 | | | | | | | | |
| | HMK212 B7 473□G | RoHS | 0.047 | | | | | | | | |
| | HMK212 B7 683□G | RoHS | 0.068 | | | | | | | | |
| | HMK212 B7 104□G | RoHS | 0.1 | | | | | | | | |
| HMK212 B7 224□G | RoHS | 0.22 | | | | | | | | | |
| 250V | QMK212 B7 102□D | RoHS | 0.001 | | 2.5 | | | 2.5 | R | ±10% ±20% | 0.85±0.1 (0.033±0.004) |
| | QMK212 B7 152□D | RoHS | 0.0015 | | | | | | | | |
| | QMK212 B7 222□D | RoHS | 0.0022 | | | | | | | | |
| | QMK212 B7 332□D | RoHS | 0.0033 | | | | | | | | |
| | QMK212 B7 472□G | RoHS | 0.0047 | | | | | | | | |
| | QMK212 B7 682□G | RoHS | 0.0068 | | | | | | | | |
| | QMK212 B7 103□G | RoHS | 0.01 | | | | | | | | |
| QMK212 B7 153□G | RoHS | 0.015 | | | | | | | | | |
| QMK212 B7 223□G | RoHS | 0.022 | | | | | | | | | |

Please specify the capacitance tolerance code.

316TYPE(1206 case size)

[Temp.char. BJ:B/X5R]

| Rated Voltage | Ordering code | EHS (Environmental Hazardous Substances) | Capacitance (μF) | Temperature characteristics | Dissipation factor [%] Max. | Soldering method R:Reflow soldering W:Wave soldering | Capacitance tolerance | Thickness (mm) (inch) | | | | | |
|----------------|----------------|--|------------------|-----------------------------|-----------------------------|--|-----------------------|-----------------------|---|-----------|------------------------|-----------|-----------------------|
| 100V | HMK316 BJ473□L | RoHS | 0.047 | B/X5R*2 | 3.5 | R | ±10% ±20% | 1.6±0.2 (0.063±0.008) | | | | | |
| | HMK316 BJ683□L | RoHS | 0.068 | | | | | | | | | | |
| | HMK316 BJ104□L | RoHS | 0.1 | | | | | | | | | | |
| | HMK316 BJ154□L | RoHS | 0.15 | | | | | | | | | | |
| | HMK316 BJ224□L | RoHS | 0.22 | | | | | | | | | | |
| | HMK316 BJ334□L | RoHS | 0.33 | | | | | | | | | | |
| | HMK316 BJ474□L | RoHS | 0.47 | | | | | | | | | | |
| HMK316 BJ105□L | RoHS | 1 | | | | | | | | | | | |
| 250V | QMK316 BJ333□L | RoHS | 0.033 | | 2.5 | | | 2.5 | R | ±10% ±20% | 1.15±0.1 (0.045±0.004) | | |
| | QMK316 BJ473□L | RoHS | 0.047 | | | | | | | | | | |
| | QMK316 BJ683□L | RoHS | 0.068 | | | | | | | | | | |
| | QMK316 BJ104□L | RoHS | 0.1 | | | | | | | | | | |
| 630V | SMK316 BJ102□F | RoHS | 0.001 | | 2.5 | | | 2.5 | | | R | ±10% ±20% | 1.6±0.2 (0.063±0.008) |
| | SMK316 BJ152□F | RoHS | 0.0015 | | | | | | | | | | |
| | SMK316 BJ222□F | RoHS | 0.0022 | | | | | | | | | | |
| | SMK316 BJ332□F | RoHS | 0.0033 | | | | | | | | | | |
| | SMK316 BJ472□F | RoHS | 0.0047 | | | | | | | | | | |
| | SMK316 BJ682□F | RoHS | 0.0068 | | | | | | | | | | |
| | SMK316 BJ103□F | RoHS | 0.01 | | | | | | | | | | |
| | SMK316 BJ153□L | RoHS | 0.015 | | | | | | | | | | |
| SMK316 BJ223□L | RoHS | 0.022 | | | | | | | | | | | |

Please specify the capacitance tolerance code.

*2 : We may provide X7R for some items according to the individual specification.

[Temp.char. B7:X7R]

| Rated Voltage | Ordering code | EHS (Environmental Hazardous Substances) | Capacitance (μF) | Temperature characteristics | Dissipation factor [%] Max. | Soldering method R:Reflow soldering W:Wave soldering | Capacitance tolerance | Thickness (mm) (inch) | | | | | |
|-----------------|-----------------|--|------------------|-----------------------------|-----------------------------|--|-----------------------|-----------------------|---|-----------|------------------------|-----------|-----------------------|
| 100V | HMK316 B7 473□L | RoHS | 0.047 | X7R | 3.5 | R | ±10% ±20% | 1.6±0.2 (0.063±0.008) | | | | | |
| | HMK316 B7 683□L | RoHS | 0.068 | | | | | | | | | | |
| | HMK316 B7 104□L | RoHS | 0.1 | | | | | | | | | | |
| | HMK316 B7 154□L | RoHS | 0.15 | | | | | | | | | | |
| | HMK316 B7 224□L | RoHS | 0.22 | | | | | | | | | | |
| | HMK316 B7 334□L | RoHS | 0.33 | | | | | | | | | | |
| | HMK316 B7 474□L | RoHS | 0.47 | | | | | | | | | | |
| HMK316 B7 105□L | RoHS | 1 | | | | | | | | | | | |
| 250V | QMK316 B7 333□L | RoHS | 0.033 | | 2.5 | | | 2.5 | R | ±10% ±20% | 1.15±0.1 (0.045±0.004) | | |
| | QMK316 B7 473□L | RoHS | 0.047 | | | | | | | | | | |
| | QMK316 B7 683□L | RoHS | 0.068 | | | | | | | | | | |
| | QMK316 B7 104□L | RoHS | 0.1 | | | | | | | | | | |
| 630V | SMK316 B7 102□F | RoHS | 0.001 | | 2.5 | | | 2.5 | | | R | ±10% ±20% | 1.6±0.2 (0.063±0.008) |
| | SMK316 B7 152□F | RoHS | 0.0015 | | | | | | | | | | |
| | SMK316 B7 222□F | RoHS | 0.0022 | | | | | | | | | | |
| | SMK316 B7 332□F | RoHS | 0.0033 | | | | | | | | | | |
| | SMK316 B7 472□F | RoHS | 0.0047 | | | | | | | | | | |
| | SMK316 B7 682□F | RoHS | 0.0068 | | | | | | | | | | |
| | SMK316 B7 103□F | RoHS | 0.01 | | | | | | | | | | |
| | SMK316 B7 153□L | RoHS | 0.015 | | | | | | | | | | |
| SMK316 B7 223□L | RoHS | 0.022 | | | | | | | | | | | |

Please specify the capacitance tolerance code.

* This catalog contains the typical specification only due to the limitation of space. When you consider purchase of our products, please check our specification. For details of each product (characteristics graph, reliability information, precautions for use, and so on), see our Web site (<http://www.ty-top.com/>) or CD catalogs.

PART NUMBERS

●325TYPE(1210 case size)

[Temp.char. BJ:B/X5R]

| Rated Voltage | Ordering code | | EHS (Environmental Hazardous Substances) | Capacitance (μF) | Temperature characteristics | Dissipation factor (%) Max. | Soldering method R:Reflow soldering W:Wave soldering | Capacitance tolerance | Thickness [mm] (inch) | | | | | |
|----------------|----------------|------|--|------------------|-----------------------------|-----------------------------|--|-----------------------|------------------------|---|-----------|-----------------------|-----------|-----------------------|
| 100V | HMK325 BJ104□F | | RoHS | 0.1 | B/X5R*2 | 3.5 | R | ±10% ±20% | 1.15±0.1 (0.045±0.004) | | | | | |
| | HMK325 BJ154□N | | RoHS | 0.15 | | | | | | | | | | |
| | HMK325 BJ224□N | | RoHS | 0.22 | | | | | | | | | | |
| | HMK325 BJ334□N | | RoHS | 0.33 | | | | | | | | | | |
| | HMK325 BJ474□N | | RoHS | 0.47 | | | | | | | | | | |
| | HMK325 BJ684□N | | RoHS | 0.68 | | | | | | | | | | |
| | HMK325 BJ105□N | | RoHS | 1 | | | | | | | | | | |
| HMK325 BJ225□N | | RoHS | 2.2 | | | | | | | | | | | |
| 250V | QMK325 BJ473□N | | RoHS | 0.047 | | 2.5 | | | 2.5 | R | ±10% ±20% | 1.9±0.2 (0.075±0.008) | | |
| | QMK325 BJ104□N | | RoHS | 0.1 | | | | | | | | | | |
| | QMK325 BJ154□N | | RoHS | 0.15 | | | | | | | | | | |
| | QMK325 BJ224□N | | RoHS | 0.22 | | | | | | | | | | |
| 630V | SMK325 BJ223□N | | RoHS | 0.022 | | 0.047 | | | 0.047 | | | R | ±10% ±20% | 1.9±0.2 (0.075±0.008) |
| | SMK325 BJ333□N | | RoHS | 0.033 | | | | | | | | | | |
| | SMK325 BJ473□N | | RoHS | 0.047 | | | | | | | | | | |

□ Please specify the capacitance tolerance code.

*2 : We may provide X7R for some items according to the individual specification.

[Temp.char. B7:X7R]

| Rated Voltage | Ordering code | | EHS (Environmental Hazardous Substances) | Capacitance (μF) | Temperature characteristics | Dissipation factor (%) Max. | Soldering method R:Reflow soldering W:Wave soldering | Capacitance tolerance | Thickness [mm] (inch) | | | | | |
|-----------------|-----------------|------|--|------------------|-----------------------------|-----------------------------|--|-----------------------|------------------------|---|-----------|-----------------------|-----------|-----------------------|
| 100V | HMK325 B7 104□F | | RoHS | 0.1 | X7R | 3.5 | R | ±10% ±20% | 1.15±0.1 (0.045±0.004) | | | | | |
| | HMK325 B7 154□N | | RoHS | 0.15 | | | | | | | | | | |
| | HMK325 B7 224□N | | RoHS | 0.22 | | | | | | | | | | |
| | HMK325 B7 334□N | | RoHS | 0.33 | | | | | | | | | | |
| | HMK325 B7 474□N | | RoHS | 0.47 | | | | | | | | | | |
| | HMK325 B7 684□N | | RoHS | 0.68 | | | | | | | | | | |
| | HMK325 B7 105□N | | RoHS | 1 | | | | | | | | | | |
| HMK325 B7 225□N | | RoHS | 2.2 | | | | | | | | | | | |
| 250V | QMK325 B7 473□N | | RoHS | 0.047 | | 2.5 | | | 2.5 | R | ±10% ±20% | 1.9±0.2 (0.075±0.008) | | |
| | QMK325 B7 104□N | | RoHS | 0.1 | | | | | | | | | | |
| | QMK325 B7 154□N | | RoHS | 0.15 | | | | | | | | | | |
| | QMK325 B7 224□N | | RoHS | 0.22 | | | | | | | | | | |
| 630V | SMK325 B7 223□N | | RoHS | 0.022 | | 0.047 | | | 0.047 | | | R | ±10% ±20% | 1.9±0.2 (0.075±0.008) |
| | SMK325 B7 333□N | | RoHS | 0.033 | | | | | | | | | | |
| | SMK325 B7 473□N | | RoHS | 0.047 | | | | | | | | | | |

□ Please specify the capacitance tolerance code.

●432TYPE(1812 case size)

[Temp.char. BJ:B/X5R]

| Rated Voltage | Ordering code | | EHS (Environmental Hazardous Substances) | Capacitance (μF) | Temperature characteristics | tan δ Dissipation factor (%) Max. | Soldering method R:Reflow soldering W:Wave soldering | Capacitance tolerance | Thickness [mm] (inch) | | | | | | | |
|---------------|----------------|--|--|------------------|-----------------------------|-----------------------------------|--|-----------------------|-----------------------|-------|---|-----------|-----------------------|---|-----------|-----------------------|
| 100V | HMK432 BJ474□M | | RoHS | 0.47 | B/X5R*2 | 3.5 | R | ±10% ±20% | 2.5±0.2 (0.098±0.008) | | | | | | | |
| | HMK432 BJ105□M | | RoHS | 1 | | | | | | | | | | | | |
| | HMK432 BJ155□M | | RoHS | 1.5 | | | | | | | | | | | | |
| | HMK432 BJ225□M | | RoHS | 2.2 | | | | | | | | | | | | |
| 250V | QMK432 BJ104□M | | RoHS | 0.1 | | 2.5 | | | | 2.5 | R | ±10% ±20% | 2.5±0.2 (0.098±0.008) | | | |
| | QMK432 BJ224□M | | RoHS | 0.22 | | | | | | | | | | | | |
| | QMK432 BJ334□M | | RoHS | 0.33 | | | | | | | | | | | | |
| | QMK432 BJ474□M | | RoHS | 0.47 | | | | | | | | | | | | |
| 630V | SMK432 BJ473□M | | RoHS | 0.047 | | 0.068 | | | | 0.068 | | | | R | ±10% ±20% | 2.5±0.2 (0.098±0.008) |
| | SMK432 BJ683□M | | RoHS | 0.068 | | | | | | | | | | | | |
| | SMK432 BJ104□M | | RoHS | 0.1 | | | | | | | | | | | | |

□ Please specify the capacitance tolerance code.

*2 : We may provide X7R for some items according to the individual specification.

[Temp.char. B7:X7R]

| Rated Voltage | Ordering code | | EHS (Environmental Hazardous Substances) | Capacitance (μF) | Temperature characteristics | Dissipation factor (%) Max. | Soldering method R:Reflow soldering W:Wave soldering | Capacitance tolerance | Thickness [mm] (inch) | | | | | | | |
|---------------|-----------------|--|--|------------------|-----------------------------|-----------------------------|--|-----------------------|-----------------------|-------|---|-----------|-----------------------|---|-----------|-----------------------|
| 100V | HMK432 B7 474□M | | RoHS | 0.47 | X7R | 3.5 | R | ±10% ±20% | 2.5±0.2 (0.098±0.008) | | | | | | | |
| | HMK432 B7 105□M | | RoHS | 1 | | | | | | | | | | | | |
| | HMK432 B7 155□M | | RoHS | 1.5 | | | | | | | | | | | | |
| | HMK432 B7 225□M | | RoHS | 2.2 | | | | | | | | | | | | |
| 250V | QMK432 B7 104□M | | RoHS | 0.1 | | 2.5 | | | | 2.5 | R | ±10% ±20% | 2.5±0.2 (0.098±0.008) | | | |
| | QMK432 B7 224□M | | RoHS | 0.22 | | | | | | | | | | | | |
| | QMK432 B7 334□M | | RoHS | 0.33 | | | | | | | | | | | | |
| | QMK432 B7 474□M | | RoHS | 0.47 | | | | | | | | | | | | |
| 630V | SMK432 B7 473□M | | RoHS | 0.047 | | 0.068 | | | | 0.068 | | | | R | ±10% ±20% | 2.5±0.2 (0.098±0.008) |
| | SMK432 B7 683□M | | RoHS | 0.068 | | | | | | | | | | | | |
| | SMK432 B7 104□M | | RoHS | 0.1 | | | | | | | | | | | | |

□ Please specify the capacitance tolerance code.

* This catalog contains the typical specification only due to the limitation of space. When you consider purchase of our products, please check our specification. For details of each product (characteristics graph, reliability information, precautions for use, and so on), see our Web site (<http://www.ty-top.com/>) or CD catalogs.

ELECTRICAL CHARACTERISTICS

● Example of Impedance ESR vs. Frequency characteristics

Taiyo Yuden medium-high voltage ceramic capacitor

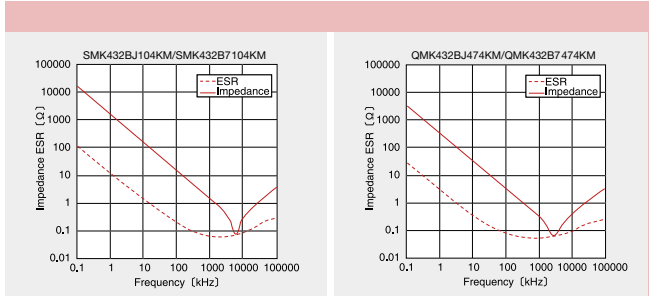
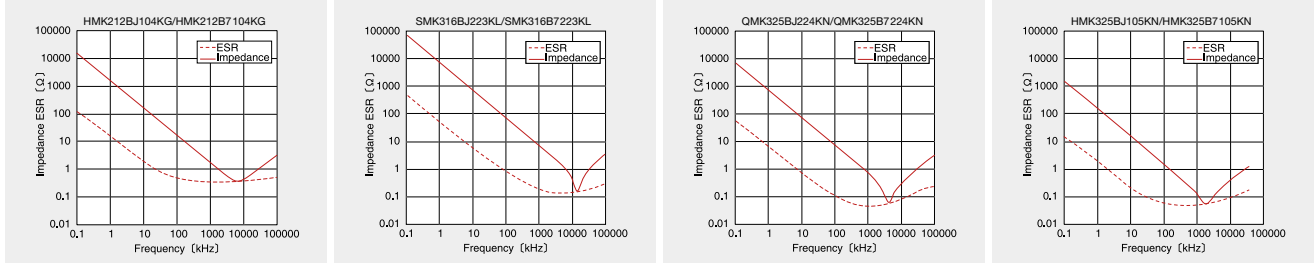

● Temperature characteristics

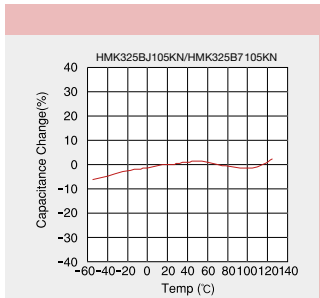

* This catalog contains the typical specification only due to the limitation of space. When you consider purchase of our products, please check our specification. For details of each product (characteristics graph, reliability information, precautions for use, and so on), see our Web site (<http://www.ty-top.com/>) or CD catalogs.

Multilayer Ceramic Capacitors and Super Low Distortion Multilayer Ceramic Capacitors are noted separately.

Medium—High Voltage Multilayer Ceramic Capacitor

| | |
|--------------------------------|---|
| 1. Operating Temperature Range | |
| Specified Value | X7R, X7S : -55~+125°C X5R : -55~+85°C B : -25~+85°C |

| | |
|------------------------------|---|
| 2. Storage Temperature Range | |
| Specified Value | X7R, X7S : -55~+125°C X5R : -55~+85°C B : -25~+85°C |

| | |
|------------------|------------------------|
| 3. Rated Voltage | |
| Specified Value | 100VDC, 250VDC, 630VDC |

| | |
|---|------------------------|
| 4. Withstanding Voltage (Between terminals) | |
| Specified Value | No breakdown or damage |

[Test Methods and Remarks]
 Applied voltage:Rated voltage×2.5 (HMK), Rated voltage×2 (QMK), Rated voltage×1.2 (SMK)
 Duration : 1 to 5sec.
 Charge/discharge current : 50mA max.

| | |
|--------------------------|--|
| 5. Insulation Resistance | |
| Specified Value | 100MΩμF or 10GΩ, whichever is smaller. |

[Test Methods and Remarks]
 Applied voltage:Rated voltage (HMK, QMK), 500V (SMK)
 Duration : 60±5sec.
 Charge/discharge current : 50mA max.

| | |
|----------------------------|------------|
| 6. Capacitance (Tolerance) | |
| Specified Value | ±10%, ±20% |

[Test Methods and Remarks]
 Measuring frequency:1kHz±10%
 Measuring voltage:1±0.2Vrms
 Bias application:None

| | |
|-----------------------|-------------------------------------|
| 7. Dissipation Factor | |
| Specified Value | 3.5%max (HMK) 2.5%max (QMK, SMK) |

[Test Methods and Remarks]
 Measuring frequency:1kHz±10%
 Measuring voltage:1±0.2Vrms
 Bias application:None

| | |
|--|--|
| 8. Temperature Characteristic of Capacitance | |
| Specified Value | B : ±10% (-25~+85°C) X5R : ±15% (-55~+85°C) X7R : ±15% (-55~+125°C) X7S : ±22% (-55~+125°C) |

[Test Methods and Remarks]
 Capacitance value at each step shall be measured in thermal equilibrium, and the temperature characteristic shall be calculated from the following equation.

| | | | |
|------|-------------------------------|---------------|--|
| Step | B | X5R, X7R, X7S | $\frac{C-C_2}{C_2} \times 100 (\%)$ C : Capacitance value in Step 1 or Step 3 C ₂ : Capacitance value in Step 2 |
| 1 | Minimum operating temperature | | |
| 2 | 20°C | 25°C | |
| 3 | Maximum operating temperature | | |

| | |
|-----------------|--|
| 9. Deflection | |
| Specified Value | Appearance:No abnormality Capacitance change:Within±10% |

[Test Methods and Remarks]
 Warp:1mm
 Duration:10sec.
 Test board:glass epoxy-resin substrate
 Thickness:1.6mm
 Capacitance measurement shall be conducted with the board bent.

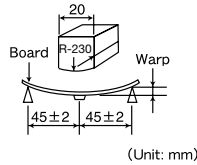

| | |
|--|---|
| 10. Adhesive Strength of Terminal Electrodes | |
| Specified Value | No terminal separation or its indication. |

[Test Methods and Remarks]
 Applied force:5N
 Duration:30±5sec.

| | |
|-------------------|---|
| 11. Solderability | |
| Specified Value | At least 95% of terminal electrode is covered by new solder |

[Test Methods and Remarks]

| | Solder type | Solder temperature | Duration |
|------------------|----------------|--------------------|----------|
| Eutectic solder | H60A or H63A | 230±5°C | 4±1 sec. |
| Lead-free solder | Sn-3.0Ag-0.5Cu | 245±3°C | |

* This catalog contains the typical specification only due to the limitation of space. When you consider purchase of our products, please check our specification. For details of each product (characteristics graph, reliability information, precautions for use, and so on), see our Web site (<http://www.ty-top.com/>) or CD catalogs.

RELIABILITY DATA

| 12. Resistance to Soldering | |
|---|---|
| Specified Value | Appearance: No abnormality Capacitance change: Within $\pm 15\%$ (HMK), $\pm 10\%$ (QMK, SMK) Dissipation factor: Initial value Insulation resistance: Initial value Withstanding voltage (between terminals): No abnormality |
| <p>[Test Methods and Remarks]</p> <p>Preconditioning: Thermal treatment (at 150°C for 1hr) Note1 Solder temperature: 270\pm5°C Duration: 3\pm0.5sec. Preheating conditions: 80 to 100°C, 2 to 5 min. 150 to 200°C, 2 to 5 min. Recovery: 24\pm2hrs under the standard condition Note3</p> | |
| 13. Temperature Cycle (Thermal Shock) | |
| Specified Value | Appearance: No abnormality Capacitance change: Within $\pm 15\%$ (HMK), $\pm 7.5\%$ (QMK, SMK) Dissipation factor: Initial value Insulation resistance: Initial value |
| <p>[Test Methods and Remarks]</p> <p>Preconditioning: Thermal treatment (at 150°C for 1hr) Note1</p> <p>Conditions for 1 cycle / Step 1: Minimum operating temperature $\pm 3^{\circ}\text{C}$ 30\pm3min. Step 2: Room temperature 2 to 3min. Step 3: Maximum operating temperature $\pm 3^{\circ}\text{C}$ 30\pm3min. Step 4: Room temperature 2 to 3min.</p> <p>Number of cycles: 5 times Recovery: 24\pm2hrs under the standard condition Note3</p> | |
| 14. Humidity (Steady state) | |
| Specified Value | Appearance: No abnormality Capacitance change: Within $\pm 15\%$ Dissipation factor: 7%max (HMK), 5%max (QMK, SMK). Insulation resistance: 25M Ω μ F or 1000M Ω , whichever is smaller. |
| <p>[Test Methods and Remarks]</p> <p>Preconditioning: Thermal treatment (at 150°C for 1hr) Note1 Temperature: 40\pm2°C Humidity: 90 to 95%RH Duration: 500 ± 24 hrs Recovery: 24\pm2hrs under the standard condition Note3</p> | |
| 15. Humidity Loading | |
| Specified Value | Appearance: No abnormality Capacitance change: Within $\pm 15\%$ Dissipation factor: 7%max (HMK), 5%max (QMK, SMK). Insulation resistance: 10M Ω μ F or 500M Ω , whichever is smaller. |
| <p>[Test Methods and Remarks]</p> <p>According to JIS 5102 clause 9.9. Preconditioning: Voltage treatment Note2 Temperature: 40\pm2°C Humidity: 90 to 95%RH Applied voltage: Rated voltage Charge/discharge current: 50mA max. Duration: 500 ± 24 hrs Recovery: 24\pm2hrs under the standard condition Note3</p> | |
| 16. High Temperature Loading | |
| Specified Value | Appearance: No abnormality Capacitance change: Within $\pm 15\%$ Dissipation factor: 7%max (HMK), 5%max (QMK, SMK). Insulation resistance: 50M Ω μ F or 1000M Ω , whichever is smaller. |
| <p>[Test Methods and Remarks]</p> <p>According to JIS 5102 clause 9.10. Preconditioning: Voltage treatment Note2 Temperature: 125\pm3°C (B7), 85\pm2°C (BJ) Applied voltage: Rated voltage\times2 (HMK) Rated voltage\times1.5 (QMK) Rated voltage\times1.2 (SMK) Charge/discharge current: 50mA max. Duration: 1000 ± 24 hrs Recovery: 24\pm2hrs under the standard condition Note3</p> | |
| Note1 | Thermal treatment: Initial value shall be measured after test sample is heat-treated at 150 \pm 0/ $-$ 10°C for an hour and kept at room temperature for 24 \pm 2hours. |
| Note2 | Voltage treatment: Initial value shall be measured after test sample is voltage-treated for an hour at both the temperature and voltage specified in the test conditions, and kept at room temperature for 24 \pm 2hours. |
| Note3 | Standard condition: Temperature: 5 to 35°C, Relative humidity: 45 to 85 % RH, Air pressure: 86 to 106kPa When there are questions concerning measurement results, in order to provide correlation data, the test shall be conducted under the following condition. Temperature: 20 \pm 2°C, Relative humidity: 60 to 70 % RH, Air pressure: 86 to 106kPa Unless otherwise specified, all the tests are conducted under the "standard condition". |

* This catalog contains the typical specification only due to the limitation of space. When you consider purchase of our products, please check our specification.
For details of each product (characteristics graph, reliability information, precautions for use, and so on), see our Web site (<http://www.ty-top.com/>) or CD catalogs.

LW REVERSAL DECOUPLING CAPACITORS (LWDC™)



REFLOW

FEATURES

- Low equivalent series resistance (ESR).
- Low equivalent series inductor (ESL).
- The effect of noise removal in the high frequency.
- Decreased ripple voltage.
- Small size with high capacitance.

APPLICATIONS

- Decoupling capacitors
- Filtering capacitors

ORDERING CODE

J | W | K | 2 | 1 | 2 | B | J | 1 | 0 | 6 | M | D | - | T | △

1 Rated voltage (VDC)

| | |
|---|-----|
| A | 4 |
| J | 6.3 |
| L | 10 |
| E | 16 |
| T | 25 |

2 Series name

| | |
|---|-----------------|
| W | LW Reverse Type |
|---|-----------------|

3 End termination

| | |
|---|--------|
| K | Plated |
|---|--------|

4 Dimensions (EIA) L×W (mm)

| | |
|------------|----------|
| 105 (0204) | 0.52×1.0 |
| 107 (0306) | 0.8×1.6 |
| 212 (0508) | 1.25×2.0 |

5 Temperature characteristics code

| | |
|----|-----|
| BJ | B |
| | X5R |
| B7 | X7R |
| C6 | X6S |
| C7 | X7S |

6 Nominal capacitance (μF)

| | |
|---------|------|
| example | |
| 105 | 1.0 |
| 106 | 10.0 |

7 Capacitance tolerance

| | |
|---|------|
| K | ±10% |
| M | ±20% |

8 Thickness (mm)

| | |
|---|------|
| P | 0.3 |
| V | 0.5 |
| A | 0.8 |
| D | 0.85 |

9 Special code

| | |
|---|------------------|
| - | Standard Product |
|---|------------------|

10 Packaging

| | |
|---|---|
| F | φ178mm Taping (2mm pitch) 0204 Type |
| T | φ178mm Taping (4mm pitch) 0306, 0508 Type |

11 Internal code

| | |
|---|------------------|
| △ | Standard Product |
|---|------------------|

△=Blank space

EXTERNAL DIMENSIONS/STANDARD QUANTITY

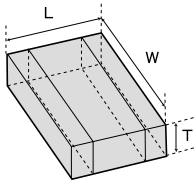

| Type (EIA) | L | W | T | Standard quantity [pcs] | | |
|---------------|----------------------------|----------------------------|----------------------------|-------------------------|---------------|------|
| | | | | Paper tape | Embossed tape | |
| □WK105 (0204) | 0.52±0.05 (0.020±0.002) | 1.00±0.05 (0.039±0.002) | 0.30±0.05 (0.012±0.002) | P | 10000 | - |
| | | | 0.50±0.05 (0.020±0.002) | V | | |
| □WK107 (0306) | 0.80±0.10 (0.031±0.004) | 1.60±0.10 (0.063±0.004) | 0.50±0.05 (0.020±0.002) | V | - | 4000 |
| □WK212 (0508) | 1.25±0.15 (0.049±0.006) | 2.00±0.15 (0.079±0.006) | 0.85±0.10 (0.033±0.004) | D | 4000 | - |

Unit : mm (inch)

AVAILABLE CAPACITANCE RANGE

| Cap [μF] | Type | 105 | | | | 107 | | | | 212 | | | | | | |
|----------|------|-----------|-----|-----|-----|-----|-----|-----|-----|-----|-----|----|----|-----|-----|----|
| | | Temp.Char | X7S | X6S | X5R | X7R | X7S | X6S | X5R | X6S | X5R | | | | | |
| | VDC | 6.3 | 4 | 6.3 | 4 | 25 | 16 | 6.3 | 4 | 4 | 25 | 16 | 10 | 6.3 | 6.3 | 10 |
| 0.10 | 104 | P | | | P | | | V | | | V | | | | | |
| 0.22 | 224 | | P | | P | | V | | | | | V | | | | |
| 0.47 | 474 | | P | P | | | V | | | | | V | | | | |
| 1.0 | 105 | | V | V | | | | V | | | | | V | V | | |
| 2.2 | 225 | | | | | | | | V | | | | | V | | |
| 4.7 | 475 | | | | | | | | | V | | | | V | D | D |
| 10.0 | 106 | | | | | | | | | | | | | V | D | D |

※ Letters in the table indicate thickness.

| Temp.char.Code | Temperature characteristics | | | | Capacitance tolerance [%] |
|----------------|-----------------------------|------------------------|-----------------|------------------------|---------------------------|
| | Applicable standard | Temperature range [°C] | Ref. Temp. [°C] | Capacitance change [%] | |
| BJ | JIS | B | -25~+85 | 20 | ±10 |
| | EIA | X5R | -55~+85 | 25 | ±15 |
| B7 | EIA | X7R | -55~+125 | 25 | ±15 |
| C6 | EIA | X6S | -55~+105 | 25 | ±22 |
| C7 | EIA | X7S | -55~+125 | 25 | ±22 |

* This catalog contains the typical specification only due to the limitation of space. When you consider purchase of our products, please check our specification. For details of each product (characteristics graph, reliability information, precautions for use, and so on), see our Web site (<http://www.ty-top.com/>) or CD catalogs.

PART NUMBERS

105TYPE (0204 case size)

[Temp.char. BJ:X5R]

| Rated Voltage | Ordering code | EHS (Environmental Hazardous Substances) | Capacitance [μ F] | Temperature characteristics | Dissipation factor [%] Max. | Soldering method R:Reflow soldering W:Wave soldering | Capacitance tolerance | Thickness [mm] (inch) |
|---------------|------------------|--|------------------------|-----------------------------|-----------------------------|--|-----------------------|------------------------------------|
| 6.3V | JWK105 BJ104MP*1 | RoHS | 0.1 | X5R*2 | 5 | R | $\pm 20\%$ (M) | 0.3 \pm 0.05 (0.012 \pm 0.002) |
| | JWK105 BJ474MP*1 | RoHS | 0.47 | | | | | 0.5 \pm 0.05 (0.020 \pm 0.002) |
| | JWK105 BJ105MV*1 | RoHS | 1 | | 10 | | | 0.3 \pm 0.05 (0.012 \pm 0.002) |
| 4V | AWK105 BJ224MP*1 | RoHS | 0.22 | | | | | 0.3 \pm 0.05 (0.012 \pm 0.002) |

*1 1.5 times the rated voltage is applied to the chip during the high temperature loading test. *2 We may provide X6S/X7S for some items according to the individual specification.

[Temp.char. C6:X6S C7:X7S]

| Rated Voltage | Ordering code | EHS (Environmental Hazardous Substances) | Capacitance [μ F] | Temperature characteristics | Dissipation factor [%] Max. | Soldering method R:Reflow soldering W:Wave soldering | Capacitance tolerance | Thickness [mm] (inch) |
|---------------|-------------------|--|------------------------|-----------------------------|-----------------------------|--|-----------------------|------------------------------------|
| 6.3V | JWK105 C7 104MP*1 | RoHS | 0.1 | X7S | 5 | R | $\pm 20\%$ (M) | 0.3 \pm 0.05 (0.012 \pm 0.002) |
| 4V | AWK105 C6 224MP*1 | RoHS | 0.22 | X6S | 10 | | | 0.5 \pm 0.05 (0.020 \pm 0.002) |
| | AWK105 C6 474MP*1 | RoHS | 0.47 | | | | | 0.5 \pm 0.05 (0.020 \pm 0.002) |
| | | AWK105 C6 105MV*1 | RoHS | 1 | | | | 0.5 \pm 0.05 (0.020 \pm 0.002) |

*1 1.5 times the rated voltage is applied to the chip during the high temperature loading test.

107TYPE (0306 case size)

[Temp.char. BJ:X5R]

| Rated Voltage | Ordering code | EHS (Environmental Hazardous Substances) | Capacitance [μ F] | Temperature characteristics | Dissipation factor [%] Max. | Soldering method R:Reflow soldering W:Wave soldering | Capacitance tolerance | Thickness [mm] (inch) |
|---------------|-------------------|--|------------------------|-----------------------------|-----------------------------|--|-----------------------|------------------------------------|
| 25V | TWK107 BJ 104MV | RoHS | 0.1 | X5R | 5 | R | $\pm 20\%$ (M) | 0.5 \pm 0.05 (0.020 \pm 0.002) |
| 16V | EWK107 BJ 224MV | RoHS | 0.22 | | | | | |
| | EWK107 BJ 474MV | RoHS | 0.47 | | | | | |
| 10V | LWK107 BJ 105MV*1 | RoHS | 1 | X5R | 10 | R | $\pm 20\%$ (M) | 0.5 \pm 0.05 (0.020 \pm 0.002) |
| 6.3V | JWK107 BJ 105MV*1 | RoHS | 1 | X5R*2 | | | | |
| | JWK107 BJ 225MV*1 | RoHS | 2.2 | X5R | | | | |
| | JWK107 BJ 475MV*1 | RoHS | 4.7 | | | | | |

*1 1.5 times the rated voltage is applied to the chip during the high temperature loading test. *2 We may provide X7R/X7S for some items according to the individual specification.

[Temp.char. B7:X7R C7:X7S C6:X6S]

| Rated Voltage | Ordering code | EHS (Environmental Hazardous Substances) | Capacitance [μ F] | Temperature characteristics | Dissipation factor [%] Max. | Soldering method R:Reflow soldering W:Wave soldering | Capacitance tolerance | Thickness [mm] (inch) |
|---------------|-------------------|--|------------------------|-----------------------------|-----------------------------|--|-----------------------|------------------------------------|
| 25V | TWK107 B7 104MV*1 | RoHS | 0.1 | X7R | 5 | R | $\pm 20\%$ (M) | 0.5 \pm 0.05 (0.020 \pm 0.002) |
| 16V | EWK107 B7 224MV*1 | RoHS | 0.22 | | | | | |
| | EWK107 B7 474MV*1 | RoHS | 0.47 | | | | | |
| 6.3V | JWK107 C7 105MV*1 | RoHS | 1 | X7S | 10 | R | $\pm 20\%$ (M) | 0.5 \pm 0.05 (0.020 \pm 0.002) |
| 4V | AWK107 C7 225MV*1 | RoHS | 2.2 | X6S | | | | |
| | | AWK107 C6 475MV*1 | RoHS | 4.7 | | | | |

*1 1.5 times the rated voltage is applied to the chip during the high temperature loading test.

212TYPE (0508 case size)

[Temp.char. BJ:X5R]

| Rated Voltage | Ordering code | EHS (Environmental Hazardous Substances) | Capacitance [μ F] | Temperature characteristics | Dissipation factor [%] Max. | Soldering method R:Reflow soldering W:Wave soldering | Capacitance tolerance | Thickness [mm] (inch) |
|---------------|------------------|--|------------------------|-----------------------------|-----------------------------|--|-----------------------|------------------------------------|
| 10V | LWK212 BJ475□D*1 | RoHS | 4.7 | X5R | 10 | R | $\pm 10\%$ (K) | 0.85 \pm 0.1 (0.033 \pm 0.004) |
| | LWK212 BJ106MD*1 | RoHS | 10 | | | | $\pm 20\%$ (M) | |
| | | | | | | | $\pm 20\%$ (M) | |

□ Please specify the capacitance tolerance code. *1 1.5 times the rated voltage is applied to the chip during the high temperature loading test.

[Temp.char. C6:X6S]

| Rated Voltage | Ordering code | EHS (Environmental Hazardous Substances) | Capacitance [μ F] | Temperature characteristics | Dissipation factor [%] Max. | Soldering method R:Reflow soldering W:Wave soldering | Capacitance tolerance | Thickness [mm] (inch) |
|---------------|-------------------|--|------------------------|-----------------------------|-----------------------------|--|-----------------------|------------------------------------|
| 6.3V | JWK212 C6 475□D*1 | RoHS | 4.7 | X6S | 10 | R | $\pm 10\%$ (K) | 0.85 \pm 0.1 (0.033 \pm 0.004) |
| | JWK212 C6 106MD*1 | RoHS | 10 | | | | $\pm 20\%$ (M) | |
| | | | | | | | $\pm 20\%$ (M) | |

□ Please specify the capacitance tolerance code. *1 1.5 times the rated voltage is applied to the chip during the high temperature loading test.

ELECTRICAL CHARACTERISTICS

Example of Impedance ESR vs. Frequency characteristics

Taiyo Yuden multilayer ceramic capacitor

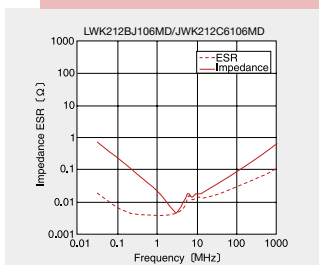
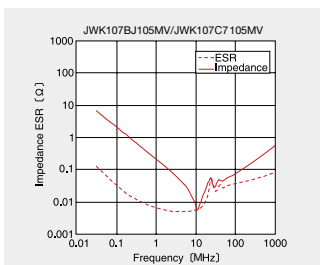

* This catalog contains the typical specification only due to the limitation of space. When you consider purchase of our products, please check our specification. For details of each product (characteristics graph, reliability information, precautions for use, and so on), see our Web site (<http://www.ty-top.com/>) or CD catalogs.

ARRAY TYPE MULTILAYER CERAMIC CAPACITORS



REFLOW

FEATURES

- High density and high efficiency mounting.
- Internal electrodes are composed of nickel for improved cost performance and reliability.

APPLICATIONS

- General electronic equipment
- Communication equipment (cellular phone, wireless applications, etc.)

ORDERING CODE

E 4 K 2 1 2 B J 1 0 4 M D - T △

1 Rated voltage (VDC)

| | |
|---|-----|
| J | 6.3 |
| L | 10 |
| E | 16 |
| T | 25 |
| U | 50 |

2 Series name

| | |
|---|---------------------------------|
| 2 | 2 circuits multilayer capacitor |
| 4 | 4 circuits multilayer capacitor |

3 End termination

| | |
|---|--------|
| K | Plated |
|---|--------|

4 Dimensions (EIA) L×W (mm)

| | |
|------------|----------|
| 096 (0302) | 0.9×0.6 |
| 110 (0504) | 1.4×1.0 |
| 212 (0805) | 2.0×1.25 |

5 Temperature characteristics code

| | |
|-----|-----|
| B | B |
| X5R | X5R |
| X7R | X7R |
| CH | CH |
| C0H | C0H |

6 Nominal capacitance (pF)

| | |
|---------|-----------|
| example | |
| 104 | 100,000 |
| 105 | 1,000,000 |

7 Capacitance tolerance

| | |
|---|------|
| F | ±1pF |
| K | ±10% |
| M | ±20% |

8 Thickness (mm)

| | |
|---|------|
| P | 0.3 |
| K | 0.45 |
| V | 0.5 |
| B | 0.6 |
| A | 0.8 |
| D | 0.85 |

9 Special code

| | |
|---|------------------|
| - | Standard Product |
|---|------------------|

10 Packaging

| | |
|---|---|
| T | φ178mm Taping (4mm pitch) 0504, 0805 Type |
| F | φ178mm Taping (2mm pitch) 0302 Type |

11 Internal code

| | |
|---|------------------|
| △ | Standard Product |
|---|------------------|

△=Blank space

EXTERNAL DIMENSIONS/STANDARD QUANTITY

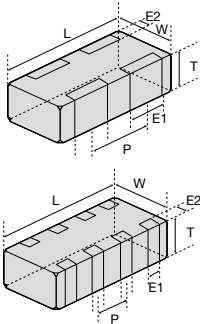

| Type (EIA) | L | W | E1 | E2 | P | T | Standard quantity [pcs] | | |
|---------------|----------------------------|----------------------------|----------------------------|------------------------------|----------------------------|---|----------------------------|---------------|---|
| | | | | | | | Paper tape | Embossed tape | |
| □2K096 (0302) | 0.9±0.05 (0.035±0.002) | 0.6±0.05 (0.024±0.002) | 0.23±0.10 (0.009±0.004) | 0.125±0.075 (0.005±0.003) | 0.45±0.05 (0.018±0.002) | P | 0.30±0.03 (0.012±0.001) | 10000 | - |
| | | | | | | K | 0.45±0.05 (0.018±0.002) | | |
| | | | | | | V | 0.5±0.05 (0.020±0.002) | | |
| □2K110 (0504) | 1.37±0.07 (0.054±0.003) | 1.00±0.08 (0.039±0.003) | 0.36±0.10 (0.014±0.004) | 0.2±0.10 (0.008±0.004) | 0.64±0.10 (0.025±0.004) | B | 0.60±0.06 (0.024±0.003) | 4000 | - |
| | | | | | | A | 0.80±0.08 (0.031±0.003) | | |
| | | | | | | D | 0.85±0.10 (0.033±0.004) | | |
| □2K212 (0805) | 2.00±0.10 (0.079±0.004) | 1.25±0.10 (0.049±0.004) | 0.50±0.20 (0.020±0.008) | 0.25±0.15 (0.010±0.006) | 1.00±0.10 (0.039±0.004) | D | 0.85±0.10 (0.033±0.004) | 4000 | - |
| □4K212 (0805) | 2.00±0.10 (0.079±0.004) | 1.25±0.10 (0.049±0.004) | 0.25±0.10 (0.010±0.004) | 0.25±0.15 (0.010±0.006) | 0.50±0.10 (0.020±0.004) | D | 0.85±0.10 (0.033±0.004) | 4000 | - |

Unit : mm (inch)

AVAILABLE CAPACITANCE RANGE

BJ/B7

| Cap [μF] | Temp. Char VDC | 096 2 circuits □2K096 | | 110 2 circuits □2K110 | | | | | | 212 2 circuits □2K212 | | 212 4 circuits □4K212 | | | | | |
|----------|----------------|-----------------------|------|-----------------------|-----|-------|-----|-----|-----|-----------------------|-----|-----------------------|-------|-----|-----|-----|-----|
| | | B/X5R | X5R | X7R | | B/X5R | | X5R | | B/X5R | X5R | X7R | B/X5R | | X5R | | |
| | | 10V | 6.3V | 50V | 25V | 16V | 50V | 25V | 16V | 10V | 16V | 10V | 16V | 25V | 16V | 10V | 10V |
| 0.001 | 102 | | | B | | | B | | | | | | | | | | |
| 0.0022 | 222 | | | B | | | B | | | | | | | | | | |
| 0.0047 | 472 | | | B | | | B | | | | | | | | | | |
| 0.01 | 103 | P | | | B | | | B | | | | | | | | | |
| 0.022 | 223 | | | | B | | | B | | | | | | | | | |
| 0.047 | 473 | | | | | B | | | B | | | | | | | | |
| 0.1 | 104 | | K | | | B | | B | B | | | | | | | | |
| 0.22 | 224 | | K | | | | | | | B | | | | | | | D |
| 0.47 | 474 | | | | | | | | | | A | | | | | | D |
| 1.0 | 105 | | | | | | | | | A | A,V | V | D | | | | D |
| 2.2 | 225 | | | | | | | | | | | A | D | | | | |

※ Letters in the table indicate thickness.

CH

| Cap [pF] | Temp. Char VDC | 096 2 circuits □2K096 | | 110 2 circuits □2K110 | |
|----------|----------------|-----------------------|-----|-----------------------|-----|
| | | CH | CH | CH | CH |
| | | 25V | 25V | 50V | 50V |
| 10 | 100 | P | | | B |
| 12 | 120 | P | | | B |
| 15 | 150 | P | | | B |
| 18 | 180 | P | | | B |
| 22 | 220 | P | | | B |
| 27 | 270 | P | | | B |
| 33 | 330 | P | | | B |
| 39 | 390 | P | | | B |
| 47 | 470 | P | | | B |
| 56 | 560 | P | | | B |
| 68 | 680 | P | | | B |
| 82 | 820 | P | | | B |
| 100 | 101 | P | | | B |

※ Letters in the table indicate thickness.

| Temp. char. Code | Temperature characteristics | | | | Capacitance tolerance (%) |
|------------------|-----------------------------|------------------------|-----------------|--------------------|---------------------------|
| | Applicable standard | Temperature range [°C] | Ref. Temp. [°C] | Capacitance change | |
| BJ | JIS | B | -25~+85 | 20 | ±10 [%] ±20 (M) |
| | EIA | X5R | -55~+85 | 25 | |
| B7 | EIA | X7R | -55~+125 | 25 | ±15 [%] ±60 [ppm/°C] |
| | JIS | CH | -55~+125 | 20 | |
| CH | EIA | C0H | -55~+125 | 25 | ±60 [ppm/°C] |
| | JIS | CH | -55~+125 | 20 | |

* This catalog contains the typical specification only due to the limitation of space. When you consider purchase of our products, please check our specification. For details of each product (characteristics graph, reliability information, precautions for use, and so on), see our Web site (<http://www.ty-top.com/>) or CD catalogs.

PART NUMBERS

● 096TYPE (0302 case size) 2 circuits type

[Temp.char. BJ:B/X5R]

| Rated Voltage | Ordering code | EHS (Environmental Hazardous Substances) | Capacitance [μ F] | Temperature characteristics | Dissipation factor [%]Max. | Soldering method R:Reflow soldering W:Wave soldering | Capacitance tolerance | Thickness [mm] [inch] |
|---------------|------------------------------|---|---------------------------|--------------------------------|----------------------------------|--|--------------------------|-----------------------------|
| 10V | L2K096 BJ103□P | RoHS | 0.01 | B/X5R | 5 | R | ±10% [K] ±20% [M] | 0.3±0.03 (0.012±0.001) |
| 6.3V | J2K096 BJ473□K ^{*1} | RoHS | 0.047 | X5R | | | | 10 |
| | J2K096 BJ104□K ^{*1} | RoHS | 0.1 | | | | | |
| | J2K096 BJ224MK ^{*1} | RoHS | 0.22 | | | | | |

□ Please specify the capacitance tolerance code.

*1 1.5 times the rated voltage is applied to the chip during the high temperature loading test.

[Temp.char. CH:CH/C0H]

| Rated Voltage | Ordering code | EHS (Environmental Hazardous Substances) | Capacitance [pF] | Temperature characteristics | Q | Soldering method R:Reflow soldering W:Wave soldering | Capacitance tolerance | Thickness [mm] [inch] |
|---------------|----------------|---|---------------------|--------------------------------|----------|--|--------------------------|-----------------------------|
| 25V | T2K096 CH100FP | RoHS | 10 | CH/C0H | 400+20·C | R | ±10% [K] | 0.3±0.03 (0.012±0.001) |
| | T2K096 CH120KP | RoHS | 12 | | | | | |
| | T2K096 CH150KP | RoHS | 15 | | | | | |
| | T2K096 CH180KP | RoHS | 18 | | | | | |
| | T2K096 CH220KP | RoHS | 22 | | | | | |
| | T2K096 CH270KP | RoHS | 27 | | | | | |
| | T2K096 CH330KP | RoHS | 33 | 1000 | | | | |
| | T2K096 CH390KP | RoHS | 39 | | | | | |
| | T2K096 CH470KP | RoHS | 47 | | | | | |
| | T2K096 CH560KP | RoHS | 56 | | | | | |
| | T2K096 CH680KP | RoHS | 68 | | | | | |
| | T2K096 CH820KP | RoHS | 82 | | | | | |
| | T2K096 CH101KP | RoHS | 100 | | | | | |

Note: Please contact Taiyo Yuden sales channels about temperature characteristics other than listed above.

● 110TYPE (0504 case size) 2 circuits type

[Temp.char. BJ:B/X5R]

| Rated Voltage | Ordering code | EHS (Environmental Hazardous Substances) | Capacitance [μ F] | Temperature characteristics | Dissipation factor [%]Max. | Soldering method R:Reflow soldering W:Wave soldering | Capacitance tolerance | Thickness [mm] [inch] |
|---------------|------------------------------|---|---------------------------|--------------------------------|----------------------------------|--|--------------------------|-----------------------------|
| 50V | U2K110 BJ102□B | RoHS | 0.001 | B/X5R ^{*2} | 3.5 | R | ±10% [K] ±20% [M] | 0.6±0.06 (0.024±0.002) |
| | U2K110 BJ222□B | RoHS | 0.0022 | | | | | |
| | U2K110 BJ472□B | RoHS | 0.0047 | | | | | |
| 25V | T2K110 BJ103□B | RoHS | 0.01 | B/X5R | 5 | R | ±10% [K] ±20% [M] | 0.6±0.06 (0.024±0.002) |
| | T2K110 BJ223□B | RoHS | 0.022 | | | | | |
| | T2K110 BJ104□B | RoHS | 0.1 | | | | | |
| 16V | E2K110 BJ473□B | RoHS | 0.047 | B/X5R ^{*2} | 3.5 | R | ±10% [K] ±20% [M] | 0.6±0.06 (0.024±0.002) |
| | E2K110 BJ104□B | RoHS | 0.1 | | | | | |
| | E2K110 BJ105□A ^{*1} | RoHS | 1.0 | | | | | |
| 10V | L2K110 BJ224□B | RoHS | 0.22 | B/X5R | 5 | R | ±10% [K] ±20% [M] | 0.6±0.06 (0.024±0.002) |
| | L2K110 BJ474□A | RoHS | 0.47 | | | | | |
| | L2K110 BJ105□A ^{*1} | RoHS | 1.0 | | | | | |
| | L2K110 BJ105MV ^{*1} | RoHS | 1.0 | | | | | |
| 6.3V | J2K110 BJ105□V ^{*1} | RoHS | 1.0 | X5R | 10 | R | ±10% [K] ±20% [M] | 0.5±0.05 (0.02±0.002) |
| | J2K110 BJ225□A ^{*1} | RoHS | 2.2 | | | | | |

□ Please specify the capacitance tolerance code.

*1 1.5 times the rated voltage is applied to the chip during the high temperature loading test.

*2 We may provide X7R for some items according to the individual specification.

[Temp.char. B7:X7R]

| Rated Voltage | Ordering code | EHS (Environmental Hazardous Substances) | Capacitance [μ F] | Temperature characteristics | Dissipation factor [%]Max. | Soldering method R:Reflow soldering W:Wave soldering | Capacitance tolerance | Thickness [mm] [inch] |
|---------------|-----------------|---|---------------------------|--------------------------------|----------------------------------|--|--------------------------|-----------------------------|
| 50V | U2K110 B7 102□B | RoHS | 0.001 | X7R | 3.5 | R | ±10% [K] ±20% [M] | 0.6±0.06 (0.024±0.002) |
| | U2K110 B7 222□B | RoHS | 0.0022 | | | | | |
| | U2K110 B7 472□B | RoHS | 0.0047 | | | | | |
| 25V | T2K110 B7 103□B | RoHS | 0.01 | X7R | 3.5 | R | ±10% [K] ±20% [M] | 0.6±0.06 (0.024±0.002) |
| | T2K110 B7 223□B | RoHS | 0.022 | | | | | |
| | T2K110 B7 473□B | RoHS | 0.047 | | | | | |
| 16V | E2K110 B7 104□B | RoHS | 0.1 | X7R | 5 | R | ±10% [K] ±20% [M] | 0.6±0.06 (0.024±0.002) |
| | E2K110 B7 104□B | RoHS | 0.1 | | | | | |

□ Please specify the capacitance tolerance code.

* This catalog contains the typical specification only due to the limitation of space. When you consider purchase of our products, please check our specification.
For details of each product (characteristics graph, reliability information, precautions for use, and so on), see our Web site (<http://www.ty-top.com/>) or CD catalogs.

PART NUMBERS

[Temp.char. CH:CH/C0H]

| Rated Voltage | Ordering code | | EHS (Environmental Hazardous Substances) | Capacitance [pF] | Temperature characteristics | Q | Soldering method R:Reflow soldering W:Wave soldering | Capacitance tolerance | Thickness [mm] [inch] |
|----------------|----------------|------|---|---------------------|--------------------------------|----------|--|--------------------------|-----------------------------|
| 50V | U2K110 CH100FB | | RoHS | 10 | CH/C0H | 400+20·C | R | ±1pF [F] | 0.6±0.06 (0.024±0.002) |
| | U2K110 CH120KB | | RoHS | 12 | | | | | |
| | U2K110 CH150KB | | RoHS | 15 | | | | | |
| | U2K110 CH180KB | | RoHS | 18 | | | | | |
| | U2K110 CH220KB | | RoHS | 22 | | | | | |
| | U2K110 CH270KB | | RoHS | 27 | | | | | |
| | U2K110 CH330KB | | RoHS | 33 | | 1000 | | ±10% [K] | |
| | U2K110 CH390KB | | RoHS | 39 | | | | | |
| | U2K110 CH470KB | | RoHS | 47 | | | | | |
| | U2K110 CH560KB | | RoHS | 56 | | | | | |
| | U2K110 CH680KB | | RoHS | 68 | | | | | |
| | U2K110 CH820KB | | RoHS | 82 | | | | | |
| U2K110 CH101KB | | RoHS | 100 | | | | | | |

Note: Please contact Taiyo Yuden sales channels about temperature characteristics other than listed above.

●212TYPE (0805 case size) 2 circuits type

[Temp.char. BJ:B/X5R]

| Rated Voltage | Ordering code | | EHS (Environmental Hazardous Substances) | Capacitance [μF] | Temperature characteristics | Dissipation factor [%] Max. | Soldering method R:Reflow soldering W:Wave soldering | Capacitance tolerance | Thickness [mm] [inch] |
|---------------|------------------|--|---|---------------------|--------------------------------|-----------------------------------|--|--------------------------|-----------------------------|
| 25V | T2K212 BJ105□D | | RoHS | 1.0 | B/X5R | 5 | R | ±10% [K] ±20% [M] | 0.85±0.1 (0.033±0.004) |
| 10V | L2K212 BJ225MD*1 | | RoHS | 2.2 | X5R | 10 | | ±20% [M] | |

Please specify the capacitance tolerance code.

*1 1.5 times the rated voltage is applied to the chip during the high temperature loading test.

●212TYPE (0805 case size) 4 circuits type

[Temp.char. BJ:B/X5R]

| Rated Voltage | Ordering code | | EHS (Environmental Hazardous Substances) | Capacitance [μF] | Temperature characteristics | Dissipation factor [%] Max. | Soldering method R:Reflow soldering W:Wave soldering | Capacitance tolerance | Thickness [mm] [inch] |
|---------------|------------------|--|---|---------------------|--------------------------------|-----------------------------------|--|--------------------------|-----------------------------|
| 25V | T4K212 BJ104□D | | RoHS | 0.1 | B/X5R | 5 | R | ±10% [K] ±20% [M] | 0.85±0.1 (0.033±0.004) |
| 16V | E4K212 BJ104□D | | RoHS | 0.1 | B/X5R*2 | | | | |
| 10V | L4K212 BJ224□D | | RoHS | 0.22 | B/X5R | | | | |
| | L4K212 BJ474□D | | RoHS | 0.47 | | | | | |
| | L4K212 BJ105□D*1 | | RoHS | 1 | X5R | 10 | | | |

Please specify the capacitance tolerance code.

*1 1.5 times the rated voltage is applied to the chip during the high temperature loading test.

*2 We may provide X7R for some items according to the individual specification.

[Temp.char. B7:X7R]

| Rated Voltage | Ordering code | | EHS (Environmental Hazardous Substances) | Capacitance [μF] | Temperature characteristics | Dissipation factor [%] Max. | Soldering method R:Reflow soldering W:Wave soldering | Capacitance tolerance | Thickness [mm] [inch] |
|---------------|-----------------|--|---|---------------------|--------------------------------|-----------------------------------|--|--------------------------|-----------------------------|
| 16V | E4K212 B7 104□D | | RoHS | 0.1 | X7R | 5 | R | ±10% [K] ±20% [M] | 0.85±0.1 (0.033±0.004) |

Please specify the capacitance tolerance code.

* This catalog contains the typical specification only due to the limitation of space. When you consider purchase of our products, please check our specification. For details of each product (characteristics graph, reliability information, precautions for use, and so on), see our Web site (<http://www.ty-top.com/>) or CD catalogs.

● Example of Impedance ESR vs. Frequency characteristics

■ Taiyo Yuden multilayer ceramic capacitor

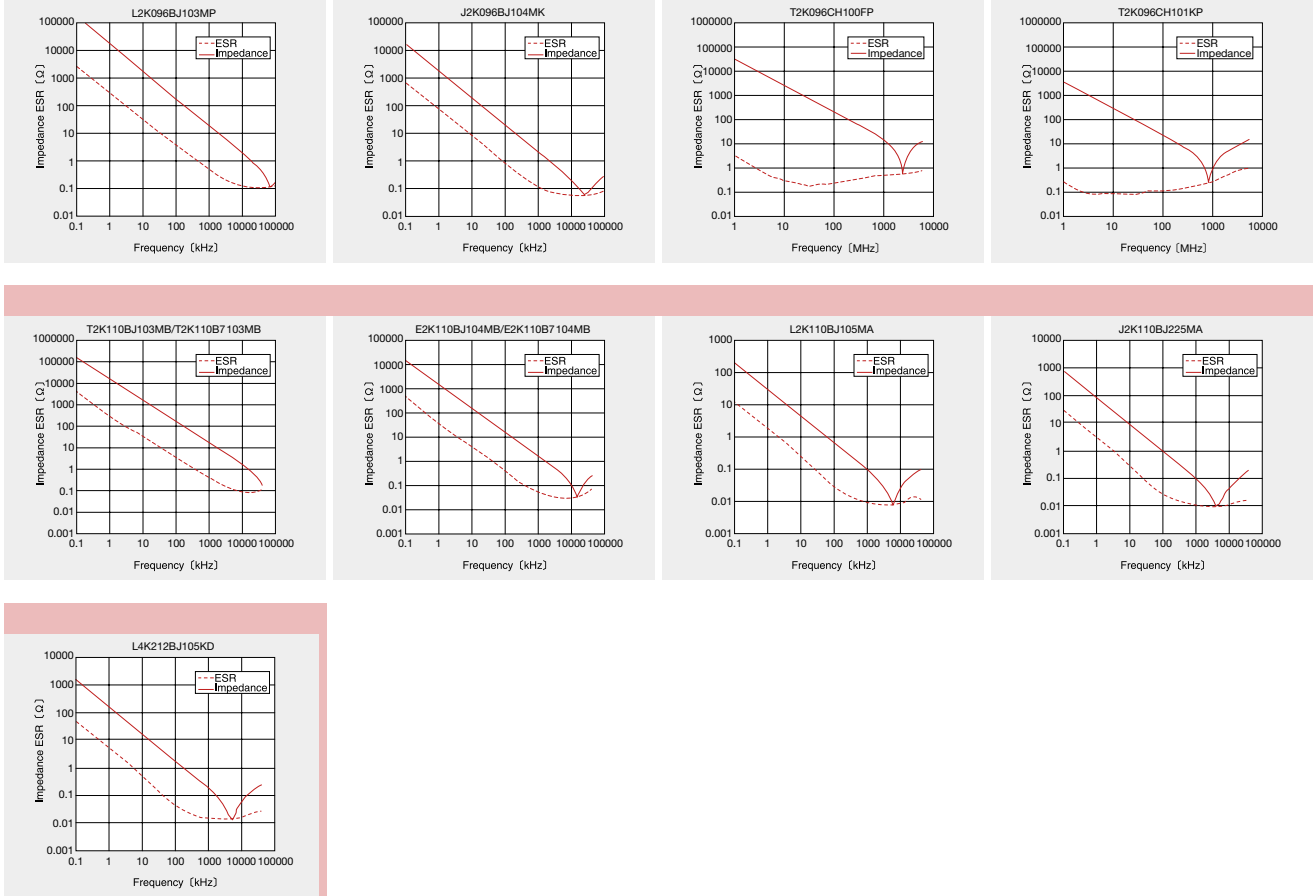

* This catalog contains the typical specification only due to the limitation of space. When you consider purchase of our products, please check our specification. For details of each product (characteristics graph, reliability information, precautions for use, and so on), see our Web site (<http://www.ty-top.com/>) or CD catalogs.

PACKAGING

① Minimum Quantity

● Taped packaging

| Type (EIA) | Thickness | | Standard quantity [pcs] | | |
|---------------|---------------|------|-------------------------|---------------|------|
| | mm (inch) | code | Paper tape | Embossed tape | |
| □MK042(01005) | 0.2(0.008) | C | 20000 | — | |
| □MK063(0201) | 0.3(0.012) | P,T | 15000 | | |
| □2K096(0302) | 0.3(0.012) | P | 10000 | | |
| □WK105(0204) | 0.45(0.018) | K | | | |
| | 0.3(0.012) | P | | | |
| | 0.5(0.020) | V | | | |
| □MK105(0402) | 0.5(0.020) | V, W | 4000 | | |
| □VK105(0402) | 0.5(0.020) | W | | | |
| □MK107(0603) | 0.45(0.018) | K | — | | 4000 |
| □WK107(0306) | 0.5(0.020) | V | | | |
| | 0.8(0.031) | A | 4000 | | |
| □2K110(0504) | 0.5(0.020) | V | | | |
| | 0.6(0.024) | B | | | |
| | 0.8(0.031) | A | | | |
| □MK212(0805) | 0.45(0.018) | K | — | 3000 | |
| □WK212(0508) | 0.85(0.033) | D | | | |
| | 1.25(0.049) | G | 4000 | | |
| □4K212(0805) | 0.85(0.033) | D | | | |
| □2K212(0805) | 0.85(0.033) | D | — | 3000 | |
| | 1.15(0.045) | F | | | |
| □MK316(1206) | 1.25(0.049) | G | | | |
| | 1.6(0.063) | L | — | 2000 | |
| | 0.85(0.033) | D | | | |
| □MK325(1210) | 1.15(0.045) | F | | | |
| | 1.9(0.075) | N | | | |
| | 2.0max(0.079) | Y | 500(T), 1000(P) | | |
| | 2.5(0.098) | M | | | |
| □MK432(1812) | 2.5(0.098) | M | — | 500 | |

② Taping material

※ No bottom tape for pressed carrier tape

● Paper tape

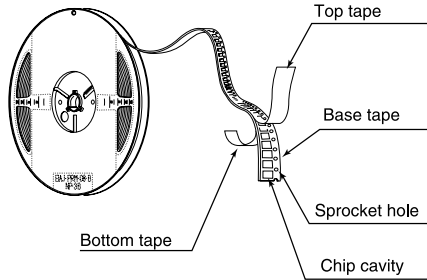

● Embossed tape

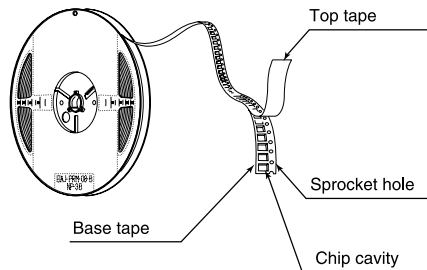

● Chip filled

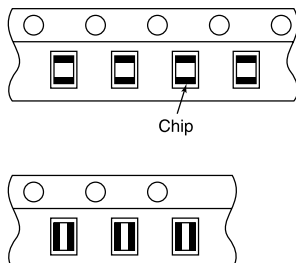

③ Taping dimensions

● Paper Tape (0.315 inches wide)

● Pressed carrier tape (2mm pitch)

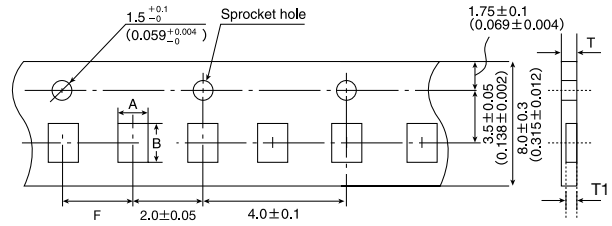

| Type (EIA) | Chip Cavity | | Insertion Pitch F | Tape Thickness | |
|---------------|-----------------|-----------------|-------------------------------|-------------------------|-------------------------|
| | A | B | | T | T1 |
| □MK042(01005) | 0.25 (0.010) | 0.45 (0.018) | 2.0 ± 0.05 (0.079 ± 0.002) | 0.36max. (0.014) | 0.27max. (0.011) |
| □MK063(0201) | 0.37 (0.016) | 0.67 (0.027) | | 0.45max. (0.018) | 0.42max. (0.017) |
| □WK105(0204) | 0.65 (0.026) | 1.15 (0.045) | | 0.45max. (0.018max.) | 0.42max. (0.017max.) |

Unit: mm (inch)

● Punched carrier tape (2mm pitch)

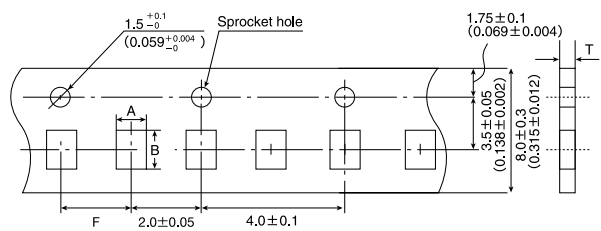

| Type (EIA) | Chip Cavity | | Insertion Pitch F | Tape Thickness |
|--------------|-----------------|-----------------|-------------------------------|---|
| | A | B | | T |
| □2K096(0302) | 0.72 (0.028) | 1.02 (0.040) | 2.0 ± 0.05 (0.079 ± 0.002) | 0.45max.(0.018max.) 0.6max.(0.024max.) |
| □MK105(0402) | 0.65 (0.026) | 1.15 (0.045) | | 0.8max. (0.031max.) |

Unit: mm (inch)

● Punched carrier tape (4mm pitch)

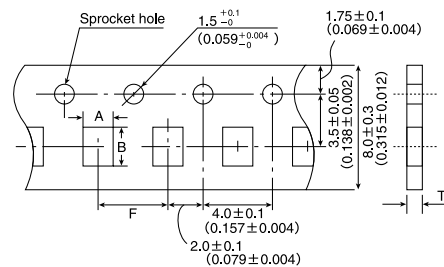

| Type (EIA) | Chip Cavity | | Insertion Pitch F | Tape Thickness |
|--------------|-----------------|-----------------|------------------------------|------------------------|
| | A | B | | T |
| □MK107(0603) | 1.0 (0.039) | 1.8 (0.071) | 4.0 ± 0.1 (0.157 ± 0.004) | 1.1max. (0.043max.) |
| □WK107(0306) | 1.15 (0.045) | 1.55 (0.061) | | 1.0max. (0.039max.) |
| □2K110(0504) | 1.65 (0.065) | 2.4 (0.094) | 4.0 ± 0.1 (0.157 ± 0.004) | 1.1max. (0.043max.) |
| □MK212(0805) | 2.0 (0.079) | 3.6 (0.142) | | 1.1max. (0.043max.) |
| □WK212(0508) | | | | |

Unit: mm (inch)

* This catalog contains the typical specification only due to the limitation of space. When you consider purchase of our products, please check our specification. For details of each product (characteristics graph, reliability information, precautions for use, and so on), see our Web site (<http://www.ty-top.com/>) or CD catalogs.

● Embossed tape (0.315 inches wide)

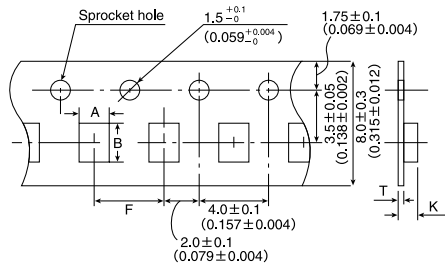

| Type(EIA) | Chip Cavity | | Insertion Pitch F | Tape Thickness | |
|--------------|-----------------|----------------|---------------------------------------|------------------------|---------------------------------------|
| | A | B | | K | T |
| □WK107(0306) | 1.0 (0.039) | 1.8 (0.071) | 4.0 ± 0.1 (0.157 ± 0.004) | 1.3max. (0.051max.) | 0.25 ± 0.1 (0.01 ± 0.004) |
| □MK212(0805) | 1.65 (0.065) | 2.4 (0.094) | | 3.4max. (0.134max.) | 0.6max. (0.024max.) |
| □MK316(1206) | 2.0 (0.079) | 3.6 (0.142) | | | |
| □MK325(1210) | 2.8 (0.110) | 3.6 (0.142) | | | |

Unit : mm (inch)

● Embossed tape (0.472 inches wide)

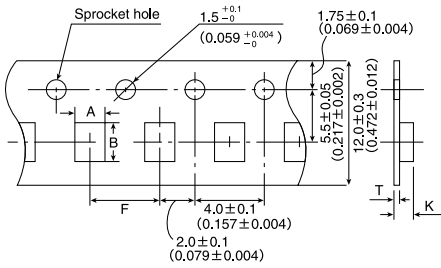

| Type(EIA) | Chip Cavity | | Insertion Pitch F | Tape Thickness | |
|--------------|----------------|----------------|---------------------------------------|------------------------|------------------------|
| | A | B | | K | T |
| □MK432(1812) | 3.7 (0.146) | 4.9 (0.193) | 8.0 ± 0.1 (0.315 ± 0.004) | 4.0max. (0.157max.) | 0.6max. (0.024max.) |

Unit : mm (inch)

④ Leader and Blank portion

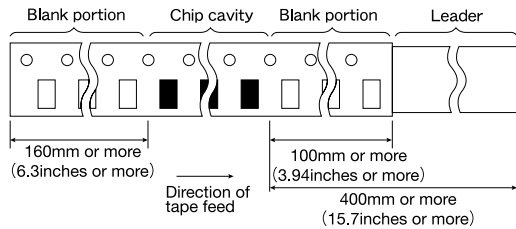

⑤ Reel size

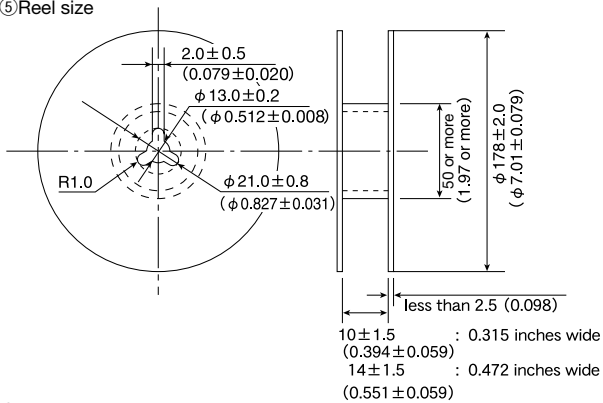

⑥ Top Tape Strength

Unit : mm (inch)

The top tape requires a peel-off force of 0.1 to 0.7N in the direction of the arrow as illustrated below.

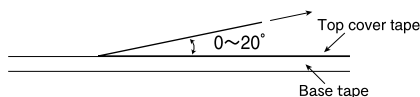

⑦ Bulk Cassette

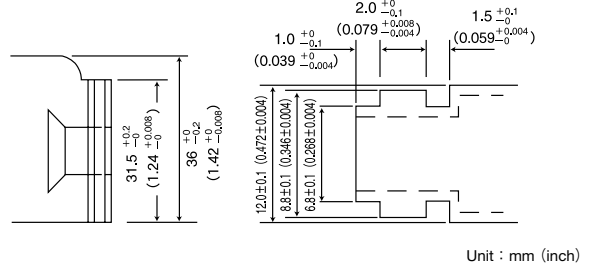
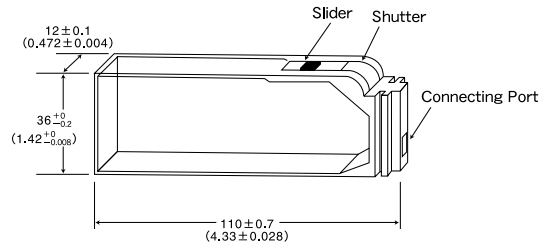

Unit : mm (inch)

* This catalog contains the typical specification only due to the limitation of space. When you consider purchase of our products, please check our specification. For details of each product (characteristics graph, reliability information, precautions for use, and so on), see our Web site (<http://www.ty-top.com/>) or CD catalogs.

Super Low Distortion Multilayer Ceramic Capacitors and Medium-High Voltage Multilayer Ceramic Capacitors are noted separately.

Multilayer Ceramic Capacitors

| 1. Operating Temperature Range | | | | |
|--------------------------------|------------------------------------|---------------------|---------------|-------------------|
| Specified Value | Temperature Compensating (Class 1) | Standard | -55 to +125°C | |
| | | High Frequency Type | | |
| Specified Value | High Permittivity (Class 2) | | Specification | Temperature Range |
| | | BJ | B | -25 to +85°C |
| | | | X5R | -55 to +85°C |
| | | B7 | X7R | -55 to +125°C |
| | | C6 | X6S | -55 to +105°C |
| | | C7 | X7S | -55 to +125°C |
| | | F | F | -25 to +85°C |
| | | | Y5V | -30 to +85°C |

| 2. Storage Temperature Range | | | | |
|------------------------------|------------------------------------|---------------------|---------------|-------------------|
| Specified Value | Temperature Compensating (Class 1) | Standard | -55 to +125°C | |
| | | High Frequency Type | | |
| Specified Value | High Permittivity (Class 2) | | Specification | Temperature Range |
| | | BJ | B | -25 to +85°C |
| | | | X5R | -55 to +85°C |
| | | B7 | X7R | -55 to +125°C |
| | | C6 | X6S | -55 to +105°C |
| | | C7 | X7S | -55 to +125°C |
| | | F | F | -25 to +85°C |
| | | | Y5V | -30 to +85°C |

| 3. Rated Voltage | | | |
|------------------|------------------------------------|---------------------|---|
| Specified Value | Temperature Compensating (Class 1) | Standard | 50VDC, 25VDC, 16VDC |
| | | High Frequency Type | 50VDC, 16VDC |
| | High Permittivity (Class 2) | | 50VDC, 35VDC, 25VDC, 16VDC, 10VDC, 6.3VDC, 4VDC |

| 4. Withstanding Voltage (Between terminals) | | | |
|---|------------------------------------|---------------------|------------------------|
| Specified Value | Temperature Compensating (Class 1) | Standard | No breakdown or damage |
| | | High Frequency Type | |
| | High Permittivity (Class 2) | | |

[Test Methods and Remarks]

| | Class 1 | Class 2 |
|--------------------------|-----------------|-------------------|
| Applied voltage | Rated voltage×3 | Rated voltage×2.5 |
| Duration | 1 to 5 sec. | |
| Charge/discharge current | 50mA max. | |

| 5. Insulation Resistance | | | |
|--------------------------|------------------------------------|---------------------|---|
| Specified Value | Temperature Compensating (Class 1) | Standard | 10000 MΩ min. |
| | | High Frequency Type | |
| | High Permittivity (Class 2) Note 1 | | C≤0.047μF : 10000 MΩ min. C>0.047μF : 500MΩ·μF |

[Test Methods and Remarks]

Applied voltage: Rated voltage
Duration: 60±5 sec.
Charge/discharge current: 50mA max.

| 6. Capacitance (Tolerance) | | | | | | | | | | | |
|----------------------------|------------------------------------|---|--|----------------------|-----------------------|-------------|----------------------|----|-----------------------|--|--------------|
| Specified Value | Temperature Compensating (Class 1) | Standard | <table border="1"> <tr> <td>C△</td> <td>0.5pF≤C≤5pF : ±0.25pF</td> <td rowspan="3">RH</td> <td rowspan="3">0.5pF≤C≤2pF : ±0.1pF</td> </tr> <tr> <td>U△</td> <td>0.5pF<C≤10pF : ±0.5pF</td> </tr> <tr> <td></td> <td>C>10pF : ±5%</td> </tr> </table> | C△ | 0.5pF≤C≤5pF : ±0.25pF | RH | 0.5pF≤C≤2pF : ±0.1pF | U△ | 0.5pF<C≤10pF : ±0.5pF | | C>10pF : ±5% |
| | | C△ | 0.5pF≤C≤5pF : ±0.25pF | RH | 0.5pF≤C≤2pF : ±0.1pF | | | | | | |
| | U△ | 0.5pF<C≤10pF : ±0.5pF | | | | | | | | | |
| | C>10pF : ±5% | | | | | | | | | | |
| | High Frequency Type | <table border="1"> <tr> <td>CH</td> <td>0.5pF≤C≤2pF : ±0.1pF</td> </tr> <tr> <td>RH</td> <td>C>2pF : ±5%</td> </tr> </table> | CH | 0.5pF≤C≤2pF : ±0.1pF | RH | C>2pF : ±5% | | | | | |
| CH | 0.5pF≤C≤2pF : ±0.1pF | | | | | | | | | | |
| RH | C>2pF : ±5% | | | | | | | | | | |
| | High Permittivity (Class 2) | | BJ, B7, C6,C7 : ±10% or ±20%, F : -20%/+80% | | | | | | | | |

[Test Methods and Remarks]

| | Class 1 | | Class 2 | |
|--------------------------|--------------|---------------------|---|-------------|
| | Standard | High Frequency Type | C≤10μF | C>10μF |
| Preconditioning | None | | Thermal treatment (at 150°C for 1hr) Note 2 | |
| Measuring frequency | 1MHz±10% | | 1kHz±10% | 120±10Hz |
| Measuring voltage Note 1 | 0.5 to 5Vrms | | 1±0.2Vrms | 0.5±0.1Vrms |
| Bias application | None | | | |

| 7. Q or Dissipation Factor | | | |
|----------------------------|------------------------------------|---------------------|---|
| Specified Value | Temperature Compensating (Class 1) | Standard | C<30 pF : Q≥400+20C, C≥30 pF : Q≥1000 (C : Nominal capacitance) |
| | | High Frequency Type | Refer to detailed specification |
| | High Permittivity (Class 2) Note 1 | | BJ, B7, C6,C7 : 2.5% max., F : 7% max. |

[Test Methods and Remarks]

| | Class 1 | | Class 2 | |
|--------------------------|--------------|---------------------|---|-------------|
| | Standard | High Frequency Type | C≤10μF | C>10μF |
| Preconditioning | None | | Thermal treatment (at 150°C for 1hr) Note 2 | |
| Measuring frequency | 1MHz±10% | 1GHz | 1kHz±10% | 120±10Hz |
| Measuring voltage Note 1 | 0.5 to 5Vrms | | 1±0.2Vrms | 0.5±0.1Vrms |
| Bias application | None | | | |

High Frequency Type
Measuring equipment: HP4291A
Measuring jig: HP16192A

* This catalog contains the typical specification only due to the limitation of space. When you consider purchase of our products, please check our specification. For details of each product (characteristics graph, reliability information, precautions for use, and so on), see our Web site (<http://www.ty-top.com/>) or CD catalogs.

RELIABILITY DATA

8. Temperature Characteristic of Capacitance (Without voltage application)

| Specified Value | Temperature Compensating (Class 1) | Standard | Temperature Characteristic [ppm/°C] | Tolerance | | | | | | | | | | | | | | | | | | | | | | | | | | | | | |
|-----------------------------|------------------------------------|-----------------------|---|------------------------|--------------------|-----------------------|-------------------|----|---|------|------|-----|------|------|----|-----|------|------|-----|------|------|----|-----|------|------|---|----------|------|--|-----|----------|------|--|
| | | High Frequency Type | C□ : 0 CH, CJ, CK R□ : -220 RH S□ : -330 SH, SJ, SK T□ : -470 TJ, TK U□ : -750 UJ, UK SL : +350 to -1000 | H±60 J±120 K±250 | | | | | | | | | | | | | | | | | | | | | | | | | | | | | |
| High Permittivity (Class 2) | | | <table border="1"> <thead> <tr> <th>Specification</th> <th>Capacitance change</th> <th>Reference temperature</th> <th>Temperature Range</th> </tr> </thead> <tbody> <tr> <td rowspan="2">BJ</td> <td>B</td> <td>±10%</td> <td>20°C</td> </tr> <tr> <td>X5R</td> <td>±15%</td> <td>25°C</td> </tr> <tr> <td rowspan="2">B7</td> <td>X7R</td> <td>±15%</td> <td>25°C</td> </tr> <tr> <td>X6S</td> <td>±22%</td> <td>25°C</td> </tr> <tr> <td rowspan="2">C7</td> <td>X7S</td> <td>±22%</td> <td>25°C</td> </tr> <tr> <td>F</td> <td>+30/-80%</td> <td>20°C</td> </tr> <tr> <td></td> <td>Y5V</td> <td>+22/-82%</td> <td>25°C</td> </tr> </tbody> </table> | Specification | Capacitance change | Reference temperature | Temperature Range | BJ | B | ±10% | 20°C | X5R | ±15% | 25°C | B7 | X7R | ±15% | 25°C | X6S | ±22% | 25°C | C7 | X7S | ±22% | 25°C | F | +30/-80% | 20°C | | Y5V | +22/-82% | 25°C | |
| Specification | Capacitance change | Reference temperature | Temperature Range | | | | | | | | | | | | | | | | | | | | | | | | | | | | | | |
| BJ | B | ±10% | 20°C | | | | | | | | | | | | | | | | | | | | | | | | | | | | | | |
| | X5R | ±15% | 25°C | | | | | | | | | | | | | | | | | | | | | | | | | | | | | | |
| B7 | X7R | ±15% | 25°C | | | | | | | | | | | | | | | | | | | | | | | | | | | | | | |
| | X6S | ±22% | 25°C | | | | | | | | | | | | | | | | | | | | | | | | | | | | | | |
| C7 | X7S | ±22% | 25°C | | | | | | | | | | | | | | | | | | | | | | | | | | | | | | |
| | F | +30/-80% | 20°C | | | | | | | | | | | | | | | | | | | | | | | | | | | | | | |
| | Y5V | +22/-82% | 25°C | | | | | | | | | | | | | | | | | | | | | | | | | | | | | | |

[Test Methods and Remarks]

Class 1

Capacitance at 20°C and 85°C shall be measured in thermal equilibrium, and the temperature characteristic shall be calculated from the following equation.

$$\frac{(C_{85}-C_{20})}{C_{20}} \times 10^6 \text{ (ppm/°C)} \quad \Delta T=65$$

Class 2

Capacitance at each step shall be measured in thermal equilibrium, and the temperature characteristic shall be calculated from the following equation.

| Step | B, F | 5R, X7R, X6S, X7S, Y5V | $\frac{(C-C_2)}{C_2} \times 100(\%)$ |
|------|-------------------------------|------------------------|--------------------------------------|
| 1 | Minimum operating temperature | | |
| 2 | 20°C | 25°C | |
| 3 | Maximum operating temperature | | |

C : Capacitance in Step 1 or Step 3
C₂ : Capacitance in Step 2

9. Deflection

| | | | |
|-----------------|------------------------------------|---------------------|---|
| Specified Value | Temperature Compensating (Class 1) | Standard | Appearance : No abnormality Capacitance change : Within ±5% or ±0.5 pF, whichever is larger. |
| | | High Frequency Type | Appearance : No abnormality Capacitance change : Within ±0.5 pF |
| | High Permittivity (Class 2) | | Appearance : No abnormality Capacitance change : Within ±12.5% (BJ, B7, C6, C7), Within ±30% (F) |

[Test Methods and Remarks]

Multilayer Ceramic Capacitors

| | Board | Thickness | Warp | Duration |
|------------------|-----------------------------|-----------|------|----------|
| 042, 063 Type | glass epoxy-resin substrate | 0.8mm | 1mm | 10 sec. |
| 105 Type or more | | 1.6mm | | |

Array Type

| | Board | Thickness | Warp | Duration |
|--------------------|-----------------------------|-----------|------|----------|
| 096, 110, 212 Type | glass epoxy-resin substrate | 1.6mm | 1mm | 10 sec. |

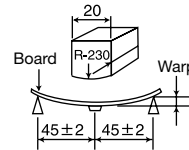

Capacitance measurement shall be conducted with the board bent (Unit: mm)

10. Body Strength

| | | | |
|-----------------|------------------------------------|---------------------|-----------------------|
| Specified Value | Temperature Compensating (Class 1) | Standard | — |
| | | High Frequency Type | No mechanical damage. |
| | High Permittivity (Class 2) | | — |

[Test Methods and Remarks]

High Frequency Type

Applied force: 5N
Duration: 10 sec.

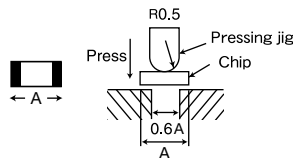

11. Adhesive Strength of Terminal Electrodes

| | | | |
|-----------------|------------------------------------|---------------------|---|
| Specified Value | Temperature Compensating (Class 1) | Standard | No terminal separation or its indication. |
| | | High Frequency Type | |
| | High Permittivity (Class 2) | | |

[Test Methods and Remarks]

Multilayer Ceramic Capacitors

| | Applied force | Duration |
|------------------|---------------|-----------|
| 042, 063 Type | 2N | 30±5 sec. |
| 105 Type or more | 5N | |

Array Type

| | Applied force | Duration |
|---------------|---------------|-----------|
| 096 Type | 2N | 30±5 sec. |
| 110, 212 Type | 5N | |

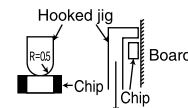

12. Solderability

| | | | |
|-----------------|------------------------------------|---------------------|--|
| Specified Value | Temperature Compensating (Class 1) | Standard | At least 95% of terminal electrode is covered by new solder. |
| | | High Frequency Type | |
| | High Permittivity (Class 2) | | |

[Test Methods and Remarks]

| | Solder type | Solder temperature | Duration |
|------------------|----------------|--------------------|----------|
| Eutectic solder | H60A or H63A | 230±5°C | 4±1 sec. |
| Lead-free solder | Sn-3.0Ag-0.5Cu | 245±3°C | |

* This catalog contains the typical specification only due to the limitation of space. When you consider purchase of our products, please check our specification. For details of each product (characteristics graph, reliability information, precautions for use, and so on), see our Web site (<http://www.ty-top.com/>) or CD catalogs.

RELIABILITY DATA

13. Resistance to Soldering

| | | | |
|-----------------|------------------------------------|---|--|
| Specified Value | Temperature Compensating (Class 1) | Standard | Appearance: No abnormality Capacitance change: Within $\pm 2.5\%$ or $\pm 0.25\text{pF}$, whichever is larger. Q: Initial value Insulation resistance: Initial value Withstanding voltage (between terminals): No abnormality |
| | | High Frequency Type | Appearance: No abnormality Capacitance change: Within $\pm 2.5\%$ Q: Initial value Insulation resistance: Initial value Withstanding voltage (between terminals): No abnormality |
| | High Permittivity (Class 2) Note 1 | Appearance: No abnormality Capacitance change: Within $\pm 7.5\%$ (BJ, B7, C6, C7) Within $\pm 20\%$ (F) Dissipation factor: Initial value Insulation resistance: Initial value Withstanding voltage (between terminals): No abnormality | |

[Test Methods and Remarks]

| Class 1 | | | Class 2 | | | |
|--------------------|---|---|--------------------|--|---|---|
| | 042, 063 Type | 105 Type Array (096, 110 Type) | | 042, 063 Type | 105, 107, 212 Type Array (096, 110, 212 Type) | 316, 325 Type |
| Preconditioning | None | | Preconditioning | Thermal treatment (at 150°C for 1 hr) Note 2 | | |
| Preheating | 150°C, 1 to 2 min. | 80 to 100°C, 2 to 5 min. 150 to 200°C, 2 to 5 min. | Preheating | 150°C, 1 to 2 min. | 80 to 100°C, 2 to 5 min. 150 to 200°C, 2 to 5 min. | 80 to 100°C, 5 to 10 min. 150 to 200°C, 5 to 10 min. |
| Solder temperature | 270 \pm 5°C | | Solder temperature | 270 \pm 5°C | | |
| Duration | 3 \pm 0.5 sec. | | Duration | 3 \pm 0.5 sec. | | |
| Recovery | 6 to 24 hrs (Standard condition) Note 5 | | Recovery | 24 \pm 2 hrs (Standard condition) Note 5 | | |

14. Temperature Cycle (Thermal Shock)

| | | | |
|-----------------|------------------------------------|---|--|
| Specified Value | Temperature Compensating (Class 1) | Standard | Appearance: No abnormality Capacitance change: Within $\pm 2.5\%$ or $\pm 0.25\text{pF}$, whichever is larger. Q: Initial value Insulation resistance: Initial value Withstanding voltage (between terminals): No abnormality |
| | | High Frequency Type | Appearance: No abnormality Capacitance change: Within $\pm 0.25\text{pF}$ Q: Initial value Insulation resistance: Initial value Withstanding voltage (between terminals): No abnormality |
| | High Permittivity (Class 2) Note 1 | Appearance: No abnormality Capacitance change: Within $\pm 7.5\%$ (BJ, B7, C6, C7) Within $\pm 20\%$ (F) Dissipation factor: Initial value Insulation resistance: Initial value Withstanding voltage (between terminals): No abnormality | |

[Test Methods and Remarks]

| | Class 1 | | Class 2 | |
|------------------|---|-------------------------------------|--|--|
| | None | | Thermal treatment (at 150°C for 1 hr) Note 2 | |
| 1 cycle | Step | Temperature (°C) | Time (min.) | |
| | 1 | Minimum operating temperature +0/-3 | 30 \pm 3 | |
| | 2 | Room temperature | 2 to 3 | |
| | 3 | Maximum operating temperature +0/-3 | 30 \pm 3 | |
| | 4 | Room temperature | 2 to 3 | |
| Number of cycles | 5 times | | | |
| Recovery | 6 to 24 hrs (Standard condition) Note 5 | | 24 \pm 2 hrs (Standard condition) Note 5 | |

15. Humidity (Steady State)

| | | | |
|-----------------|------------------------------------|--|--|
| Specified Value | Temperature Compensating (Class 1) | Standard | Appearance: No abnormality Capacitance change: Within $\pm 5\%$ or $\pm 0.5\text{pF}$, whichever is larger. Q: C < 10pF : Q \geq 200+10C 10 \leq C < 30pF : Q \geq 275+2.5C C \geq 30pF : Q \geq 350 (C : Nominal capacitance) Insulation resistance: 1000 M Ω min. |
| | | High Frequency Type | Appearance: No abnormality Capacitance change: Within $\pm 0.5\text{pF}$ Insulation resistance: 1000 M Ω min. |
| | High Permittivity (Class 2) Note 1 | Appearance: No abnormality Capacitance change: Within $\pm 12.5\%$ (BJ, B7, C6, C7) Within $\pm 30\%$ (F) Dissipation factor : 5.0% max. (BJ, B7, C6, C7) 11.0% max. (F) Insulation resistance: 50 M $\Omega\mu\text{F}$ or 1000 M Ω whichever is smaller. | |

[Test Methods and Remarks]

| Class 1 | | | Class 2 | |
|-----------------|---|---------------------|-----------------|--|
| | Standard | High Frequency Type | All items | |
| Preconditioning | None | | Preconditioning | Thermal treatment (at 150°C for 1 hr) Note 2 |
| Temperature | 40 \pm 2°C | 60 \pm 2°C | Temperature | 40 \pm 2°C |
| Humidity | 90 to 95%RH | | Humidity | 90 to 95%RH |
| Duration | 500+24/-0 hrs | | Duration | 500+24/-0 hrs |
| Recovery | 6 to 24 hrs (Standard condition) Note 5 | | Recovery | 24 \pm 2 hrs (Standard condition) Note 5 |

* This catalog contains the typical specification only due to the limitation of space. When you consider purchase of our products, please check our specification. For details of each product (characteristics graph, reliability information, precautions for use, and so on), see our Web site (<http://www.ty-top.com/>) or CD catalogs.

RELIABILITY DATA

16. Humidity Loading

| | | | |
|-----------------|------------------------------------|---|---|
| Specified Value | Temperature Compensating (Class 1) | Standard | Appearance: No abnormality Capacitance change: Within $\pm 7.5\%$ or $\pm 0.75\text{pF}$, whichever is larger. Q : $C < 30\text{pF} : Q \geq 100 + 10C/3$ $C \geq 30\text{pF} : Q \geq 200$ (C : Nominal capacitance) Insulation resistance: 500 M Ω min. |
| | | High Frequency Type | Appearance: No abnormality Capacitance change: $C \leq 2\text{pF} : \text{Within } \pm 0.4 \text{ pF}$ $C > 2\text{pF} : \text{Within } \pm 0.75 \text{ pF}$ (C : Nominal capacitance) Insulation resistance: 500 M Ω min. |
| | High Permittivity (Class 2) Note 1 | Appearance: No abnormality Capacitance change: Within $\pm 12.5\%$ (BJ, B7, C6, C7) Within $\pm 30\%$ (F) Dissipation factor : 5.0% max. (BJ, B7, C6, C7) 11.0% max. (F) Insulation resistance: 25 M $\Omega\mu\text{F}$ or 500 M Ω , whichever is smaller. | |

[Test Methods and Remarks]

Class 1

| | Standard | High Frequency Type |
|--------------------------|---|-------------------------------|
| Preconditioning | None | |
| Temperature | 40 \pm 2 $^{\circ}\text{C}$ | 60 \pm 2 $^{\circ}\text{C}$ |
| Humidity | 90 to 95%RH | |
| Duration | 500+24/-0 hrs | |
| Applied voltage | Rated voltage | |
| Charge/discharge current | 50mA max. | |
| Recovery | 6 to 24 hrs (Standard condition) Note 5 | |

Class 2

| | All items |
|--------------------------|---|
| Preconditioning | Voltage treatment (Rated voltage are applied for 1 hour at 40 $^{\circ}\text{C}$) Note 3 |
| Temperature | 40 \pm 2 $^{\circ}\text{C}$ |
| Humidity | 90 to 95%RH |
| Duration | 500+24/-0 hrs |
| Applied voltage | Rated voltage |
| Charge/discharge current | 50mA max. |
| Recovery | 24 \pm 2 hrs (Standard condition) Note 5 |

17. High Temperature Loading

| | | | |
|-----------------|------------------------------------|--|--|
| Specified Value | Temperature Compensating (Class 1) | Standard | Appearance: No abnormality Capacitance change: Within $\pm 3\%$ or $\pm 0.3\text{pF}$, whichever is larger. Q : $C < 10\text{pF} : Q \geq 200 + 10C$ $10 \leq C < 30\text{pF} : Q \geq 275 + 2.5C$ $C \geq 30\text{pF} : Q \geq 350$ (C : Nominal capacitance) Insulation resistance: 1000 M Ω min. |
| | | High Frequency Type | Appearance: No abnormality Capacitance change: Within $\pm 3\%$ or $\pm 0.3\text{pF}$, whichever is larger. Insulation resistance: 1000 M Ω min. |
| | High Permittivity (Class 2) Note 1 | Appearance: No abnormality Capacitance change: Within $\pm 12.5\%$ (BJ, B7, C6, C7) Within $\pm 30\%$ (F) Dissipation factor : 5.0% max. (BJ, B7, C6, C7) 11.0% max. (F) Insulation resistance: 50 M $\Omega\mu\text{F}$ or 1000 M Ω , whichever is smaller. | |

[Test Methods and Remarks]

Class 1

| | Standard | High Frequency Type |
|--------------------------|---------------------------------------|---------------------|
| Preconditioning | None | |
| Temperature | 125 \pm 3 $^{\circ}\text{C}$ | |
| Duration | 1000+48/-0 hrs | |
| Applied voltage | Rated voltage \times 2 | |
| Charge/discharge current | 50mA max. | |
| Recovery | 6 to 24hr (Standard condition) Note 5 | |

Class 2

| | BJ, F | C6 | B7, C7 |
|--------------------------|--|--------------------------------|--------------------------------|
| Preconditioning | Voltage treatment (Twice the rated voltage shall be applied for 1 hour at 85 $^{\circ}\text{C}$, 105 $^{\circ}\text{C}$ or 125 $^{\circ}\text{C}$) Note 3, 4 | | |
| Temperature | 85 \pm 2 $^{\circ}\text{C}$ | 105 \pm 3 $^{\circ}\text{C}$ | 125 \pm 3 $^{\circ}\text{C}$ |
| Duration | 1000+48/-0 hrs | | |
| Applied voltage | Rated voltage \times 2 Note 4 | | |
| Charge/discharge current | 50mA max. | | |
| Recovery | 24 \pm 2 hrs (Standard condition) Note 5 | | |

Note 1 The figures indicate typical specifications. Please refer to individual specifications in detail.

Note 2 Thermal treatment : Initial value shall be measured after test sample is heat-treated at 150+0/-10 $^{\circ}\text{C}$ for an hour and kept at room temperature for 24 \pm 2hours.

Note 3 Voltage treatment : Initial value shall be measured after test sample is voltage-treated for an hour at both the temperature and voltage specified in the test conditions, and kept at room temperature for 24 \pm 2hours.

Note 4 Standard condition: Temperature: 5 to 35 $^{\circ}\text{C}$, Relative humidity: 45 to 85 % RH, Air pressure: 86 to 106kPa
When there are questions concerning measurement results, in order to provide correlation data, the test shall be conducted under the following condition.

Temperature: 20 \pm 2 $^{\circ}\text{C}$, Relative humidity: 60 to 70 % RH, Air pressure: 86 to 106kPa
Unless otherwise specified, all the tests are conducted under the "standard condition".

PRECAUTIONS

Precautions on the use of Multilayer Ceramic Capacitors

1. Circuit Design

- ◆ Verification of operating environment, electrical rating and performance
 1. A malfunction of equipment in fields such as medical, aerospace, nuclear control, etc. may cause serious harm to human life or have severe social ramifications. Therefore, any capacitors to be used in such equipment may require higher safety and reliability, and shall be clearly differentiated from them used in general purpose applications.
- ◆ Operating Voltage (Verification of Rated voltage)
 1. The operating voltage for capacitors must always be their rated voltage or less.
 If an AC voltage is loaded on a DC voltage, the sum of the two peak voltages shall be the rated voltage or less.
 For a circuit where an AC or a pulse voltage may be used, the sum of their peak voltages shall also be the rated voltage or less.
2. Even if an applied voltage is the rated voltage or less reliability of capacitors may be deteriorated in case that either a high frequency AC voltage or a pulse voltage having rapid rise time is used in a circuit.

2. PCB Design

- ◆ Pattern configurations (Design of Land-patterns)
 1. When capacitors are mounted on PCBs, the amount of solder used (size of fillet) can directly affect the capacitor performance. Therefore, the following items must be carefully considered in the design of land patterns:
 (1) Excessive solder applied can cause mechanical stresses which lead to chip breaking or cracking. Therefore, please consider appropriate land-patterns for proper amount of solder.
 (2) When more than one component are jointly soldered onto the same land, each component's soldering point shall be separated by solder-resist.
- ◆ Pattern configurations (Capacitor layout on PCBs)
 After capacitors are mounted on boards, they can be subjected to mechanical stresses in subsequent manufacturing processes (PCB cutting, board inspection, mounting of additional parts, assembly into the chassis, wave soldering of the boards, etc.). For this reason, land pattern configurations and positions of capacitors shall be carefully considered to minimize stresses.

- ◆ Pattern configurations (Design of Land-patterns)
 The following diagrams and tables show some examples of recommended land patterns to prevent excessive solder amounts.

(1) Recommended land dimensions for typical chip capacitors

- Multilayer Ceramic Capacitors : Recommended land dimensions (unit: mm)
 Wave-soldering

| Type | 107 | 212 | 316 | 325 | |
|------|------------|------------|------------|------------|-----|
| Size | L | 1.6 | 2.0 | 3.2 | 3.2 |
| | W | 0.8 | 1.25 | 1.6 | 2.5 |
| A | 0.8 to 1.0 | 1.0 to 1.4 | 1.8 to 2.5 | 1.8 to 2.5 | |
| B | 0.5 to 0.8 | 0.8 to 1.5 | 0.8 to 1.7 | 0.8 to 1.7 | |
| C | 0.6 to 0.8 | 0.9 to 1.2 | 1.2 to 1.6 | 1.8 to 2.5 | |

Reflow-soldering

| Type | 042 | 063 | 105 | 107 | 212 | 316 | 325 | 432 |
|------|--------------|--------------|--------------|------------|------------|------------|------------|------------|
| Size | L | 0.4 | 0.6 | 1.0 | 1.6 | 2.0 | 3.2 | 4.5 |
| | W | 0.2 | 0.3 | 0.5 | 0.8 | 1.25 | 1.6 | 3.2 |
| A | 0.15 to 0.25 | 0.20 to 0.30 | 0.45 to 0.55 | 0.8 to 1.0 | 0.8 to 1.2 | 1.8 to 2.5 | 1.8 to 2.5 | 2.5 to 3.5 |
| B | 0.15 to 0.20 | 0.20 to 0.30 | 0.40 to 0.50 | 0.6 to 0.8 | 0.8 to 1.2 | 1.0 to 1.5 | 1.0 to 1.5 | 1.5 to 1.8 |
| C | 0.15 to 0.30 | 0.25 to 0.40 | 0.45 to 0.55 | 0.6 to 0.8 | 0.9 to 1.6 | 1.2 to 2.0 | 1.8 to 3.2 | 2.3 to 3.5 |

- LWDC: Recommended land dimensions for reflow-soldering (unit: mm)

| Type | 105 | 107 | 212 | |
|------|--------------|-------------|------------|------|
| Size | L | 0.52 | 0.8 | 1.25 |
| | W | 1.0 | 1.6 | 2.0 |
| A | 0.18 to 0.22 | 0.25 to 0.3 | 0.5 to 0.7 | |
| B | 0.2 to 0.25 | 0.3 to 0.4 | 0.4 to 0.5 | |
| C | 0.9 to 1.1 | 1.5 to 1.7 | 1.9 to 2.1 | |

(unit: mm)

- Array type: Recommended land dimensions for reflow-soldering (unit: mm)

| Type | 096 (2 circuits) | 110 (2 circuits) | 212 (2 circuits) | 212 (4 circuits) | |
|------|------------------|------------------|------------------|------------------|------|
| Size | L | 0.9 | 1.37 | 2.0 | 2.0 |
| | W | 0.6 | 1.0 | 1.25 | 1.25 |
| a | 0.25 to 0.35 | 0.35 to 0.45 | 0.5 to 0.6 | 0.5 to 0.6 | |
| b | 0.15 to 0.25 | 0.55 to 0.65 | 0.5 to 0.6 | 0.5 to 0.6 | |
| c | 0.15 to 0.25 | 0.3 to 0.4 | 0.5 to 0.6 | 0.2 to 0.3 | |
| d | 0.45 | 0.64 | 1.0 | 0.5 | |

Land patterns for PCBs

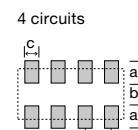
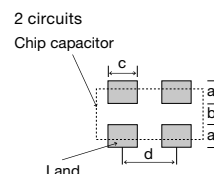
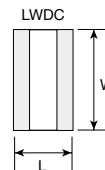
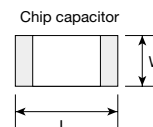
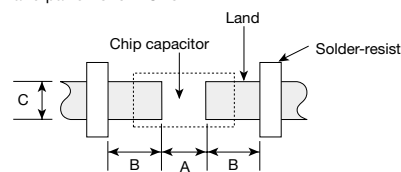

Technical considerations

(2) Examples of good and bad solder application

| Items | Not recommended | Recommended |
|---|--|---------------|
| Mixed mounting of SMD and leaded components | Lead wire of component | Solder-resist |
| Component placement close to the chassis | Chassis Solder (for grounding) Land | Solder-resist |
| Hand-soldering of leaded components near mounted components | Lead wire of component Soldering iron | Solder-resist |
| Horizontal component placement | | Solder-resist |

To next page

* This catalog contains the typical specification only due to the limitation of space. When you consider purchase of our products, please check our specification. For details of each product (characteristics graph, reliability information, precautions for use, and so on), see our Web site (<http://www.ty-top.com/>) or CD catalogs.

PRECAUTIONS

Precautions on the use of Multilayer Ceramic Capacitors

2. PCB Design

◆Pattern configurations (Capacitor layout on PCBs)

1-1. The following are examples of good and bad capacitor layouts ; capacitors shall be located to minimize any possible mechanical stresses from board warp or deflection.

| Items | Not recommended | Recommended |
|---------------------|-----------------|---|
| Deflection of board | | Position the component at a right angle to the direction of the mechanical stresses that are anticipated. |

Technical considerations

1-2. The amount of mechanical stresses given will vary depending on capacitor layout. Please refer to diagram below.

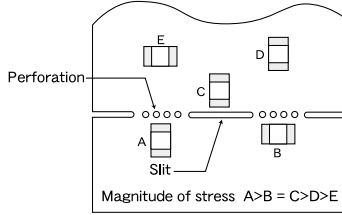

1-3. When PCB is split, the amount of mechanical stress on the capacitors can vary according to the method used. The following methods are listed in order from least stressful to most stressful: push-back, slit, V-grooving, and perforation. Thus, please consider the PCB split methods as well as chip location.

3. Mounting

◆Adjustment of mounting machine

- When capacitors are mounted on PCB, excessive impact load shall not be imposed on them.
- Maintenance and inspection of mounting machines shall be conducted periodically.

Precautions

◆Selection of Adhesives

1. When chips are attached on PCBs with adhesives prior to soldering, it may cause capacitor characteristics degradation unless the following factors are appropriately checked : size of land patterns, type of adhesive, amount applied, hardening temperature and hardening period. Therefore, please contact us for further information.

◆Adjustment of mounting machine

1. When the bottom dead center of a pick-up nozzle is too low, excessive force is imposed on capacitors and causes damages. To avoid this, the following points shall be considerable.

- The bottom dead center of the pick-up nozzle shall be adjusted to the surface level of PCB without the board deflection.
- The pressure of nozzle shall be adjusted between 1 and 3 N static loads.

(3) To reduce the amount of deflection of the board caused by impact of the pick-up nozzle, supporting pins or back-up pins shall be used on the other side of the PCB. The following diagrams show some typical examples of good and bad pick-up nozzle placement:

| Items | Not recommended | Recommended |
|-----------------------|-----------------|-------------|
| Single-sided mounting | | |
| Double-sided mounting | | |

Technical considerations

2. As the alignment pin is worn out, adjustment of the nozzle height can cause chipping or cracking of capacitors because of mechanical impact on the capacitors. To avoid this, the monitoring of the width between the alignment pins in the stopped position, maintenance, check and replacement of the pin shall be conducted periodically.

◆Selection of Adhesives

Some adhesives may cause IR deterioration. The different shrinkage percentage of between the adhesive and the capacitors may result in stresses on the capacitors and lead to cracking. Moreover, too little or too much adhesive applied to the board may adversely affect components. Therefore, the following precautions shall be noted in the application of adhesives.

(1) Required adhesive characteristics

- The adhesive shall be strong enough to hold parts on the board during the mounting & solder process.
- The adhesive shall have sufficient strength at high temperatures.
- The adhesive shall have good coating and thickness consistency.
- The adhesive shall be used during its prescribed shelf life.
- The adhesive shall harden rapidly.
- The adhesive shall have corrosion resistance.
- The adhesive shall have excellent insulation characteristics.
- The adhesive shall have no emission of toxic gasses and no effect on the human body.

(2) The recommended amount of adhesives is as follows;

[Recommended condition]

| Figure | 212/316 case sizes as examples |
|--------|----------------------------------|
| a | 0.3mm min |
| b | 100 to 120 μm |
| c | Adhesives shall not contact land |

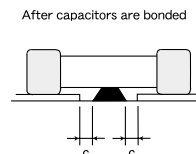
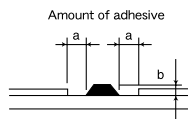

* This catalog contains the typical specification only due to the limitation of space. When you consider purchase of our products, please check our specification. For details of each product (characteristics graph, reliability information, precautions for use, and so on), see our Web site (<http://www.ty-top.com/>) or CD catalogs.

PRECAUTIONS

Precautions on the use of Multilayer Ceramic Capacitors

4. Soldering

Precautions

◆ Selection of Flux

- Since flux may have a significant effect on the performance of capacitors, it is necessary to verify the following conditions prior to use;
- (1) Flux used shall be less than or equal to 0.1 wt% (in Cl equivalent) of halogenated content. Flux having a strong acidity content shall not be applied.
 - (2) When shall capacitors are soldered on boards, the amount of flux applied shall be controlled at the optimum level.
 - (3) When water-soluble flux is used, special care shall be taken to properly clean the boards.

◆ Soldering

Temperature, time, amount of solder, etc. shall be set in accordance with their recommended conditions.

Sn-Zn solder paste can adversely affect MLCC reliability.
Please contact us prior to usage of Sn-Zn solder.

◆ Selection of Flux

- 1-1. When too much halogenated substance (**Chlorine, etc.**) content is used to activate flux, or highly acidic flux is used, it may lead to corrosion of terminal electrodes or degradation of insulation resistance on the surfaces of the capacitors.
- 1-2. Flux is used to increase solderability in wave soldering. However if too much flux is applied, a large amount of flux gas may be emitted and may adversely affect the solderability. To minimize the amount of flux applied, it is recommended to use a flux-bubbling system.
- 1-3. Since the residue of water-soluble flux is easily dissolved in moisture in the air, the residues on the surfaces of capacitors in high humidity conditions may cause a degradation of insulation resistance and reliability of the capacitors. Therefore, the cleaning methods and the capability of the machines used shall also be considered carefully when water-soluble flux is used.

◆ Soldering

- Ceramic chip capacitors are susceptible to thermal shock when exposed to rapid or concentrated heating or rapid cooling.
- Therefore, the soldering must be conducted with great care so as to prevent malfunction of the components due to excessive thermal shock.
- Preheating : Capacitors shall be preheated sufficiently, and the temperature difference between the capacitors and solder shall be within 100 to 130°C.
- Cooling : The temperature difference between the capacitors and cleaning process shall not be greater than 100°C.

[Reflow soldering]

[Recommended conditions for eutectic soldering]

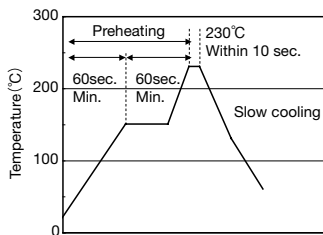

[Recommended condition for Pb-free soldering]

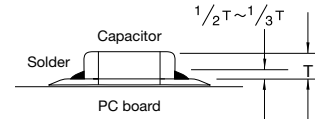
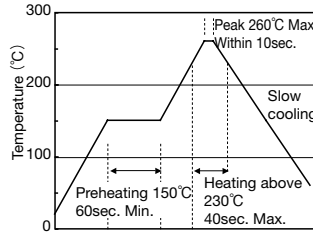

Caution

- ① The ideal condition is to have solder mass (fillet) controlled to 1/2 to 1/3 of the thickness of a capacitor.
- ② Because excessive dwell times can adversely affect solderability, soldering duration shall be kept as close to recommended times as possible.

Technical considerations

[Wave soldering]

[Recommended conditions for eutectic soldering]

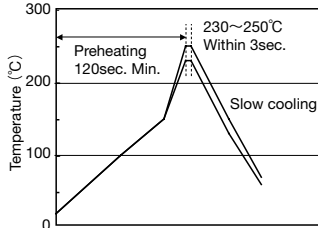

[Recommended condition for Pb-free soldering]

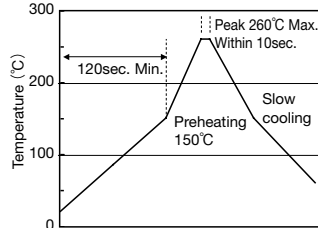

Caution

- ① Wave soldering must not be applied to capacitors designated as for reflow soldering only.

[Hand soldering]

[Recommended conditions for eutectic soldering]

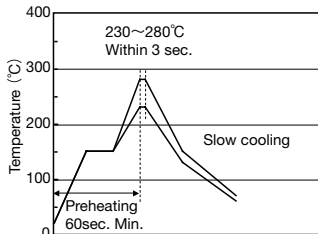

[Recommended condition for Pb-free soldering]

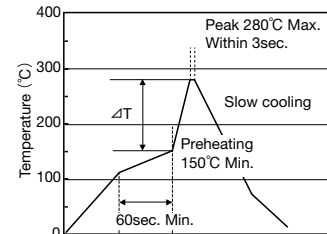
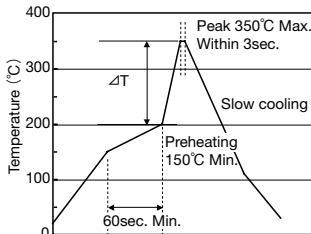

Caution

- ① Use a 50W soldering iron with a maximum tip diameter of 1.0 mm.
- ② The soldering iron shall not directly touch capacitors.

* This catalog contains the typical specification only due to the limitation of space. When you consider purchase of our products, please check our specification. For details of each product (characteristics graph, reliability information, precautions for use, and so on), see our Web site (<http://www.ty-top.com/>) or CD catalogs.

■ PRECAUTIONS

Precautions on the use of Multilayer Ceramic Capacitors

| 5. Cleaning | |
|---------------------------|---|
| Precautions | <p>◆Cleaning conditions</p> <ol style="list-style-type: none"> When PCBs are cleaned after capacitors mounting, Please select the appropriate cleaning solution in accordance with the intended use of the cleaning. (e.g. to remove soldering flux or other materials from the production process.) Cleaning condition shall be determined after it is verified by using actual cleaning machine that the cleaning process does not affect capacitor's characteristics. |
| Technical considerations | <ol style="list-style-type: none"> The use of inappropriate cleaning solutions can cause foreign substances such as flux residue to adhere to capacitors or deteriorate their outer coating, resulting in a degradation of the capacitor's electrical properties (especially insulation resistance). Inappropriate cleaning conditions (insufficient or excessive cleaning) may adversely affect the performance of the capacitors. In the case of ultrasonic cleaning, too much power output can cause excessive vibration of PCBs which may lead to the cracking of capacitors or the soldered portion, or decrease the terminal electrodes' strength. Therefore, the following conditions shall be carefully checked; Ultrasonic output : 20 W/l or less Ultrasonic frequency : 40 kHz or less Ultrasonic washing period : 5 min. or less |
| 6. Resin coating and mold | |
| Precautions | <ol style="list-style-type: none"> With some type of resins, decomposition gas or chemical reaction vapor may remain inside the resin during the hardening period or while left under normal storage conditions resulting in the deterioration of the capacitor's performance. When a resin's hardening temperature is higher than capacitor's operating temperature, the stresses generated by the excessive heat may lead to damage or destruction of capacitors. The use of such resins, molding materials etc. is not recommended. |
| 7. Handling | |
| Precautions | <p>◆Splitting of PCB</p> <ol style="list-style-type: none"> When PCBs are split after components mounting, care shall be taken so as not to give any stresses of deflection or twisting to the board. Board separation shall not be done manually, but by using the appropriate devices. <p>◆Mechanical considerations</p> <p>Be careful not to subject capacitors to excessive mechanical shocks.</p> <ol style="list-style-type: none"> If ceramic capacitors are dropped onto a floor or a hard surface, they shall not be used. Please be careful that the mounted components do not come in contact with or bump against other boards or components. |
| 8. Storage conditions | |
| Precautions | <p>◆Storage</p> <ol style="list-style-type: none"> To maintain the solderability of terminal electrodes and to keep packaging materials in good condition, care must be taken to control temperature and humidity in the storage area. Humidity should especially be kept as low as possible. <ul style="list-style-type: none"> Recommended conditions <ul style="list-style-type: none"> Ambient temperature : Below 30°C Humidity : Below 70% RH <p>The ambient temperature must be kept below 40°C. Even under ideal storage conditions, solderability of capacitor is deteriorated as time passes, so capacitors shall be used within 6 months from the time of delivery.</p> <ul style="list-style-type: none"> Ceramic chip capacitors shall be kept where no chlorine or sulfur exists in the air. The capacitance values of high dielectric constant capacitors will gradually decrease with the passage of time. So care shall be taken to design circuits. Even if capacitance value decreases as time passes, it will get back to the initial value by a heat treatment at 150°C for 1hour. |
| Technical considerations | <p>If capacitors are stored in a high temperature and humidity environment, it might rapidly cause poor solderability due to terminal oxidation and quality loss of taping/packaging materials. For this reason, capacitors shall be used within 6 months from the time of delivery. If exceeding the above period, please check solderability before using the capacitors.</p> |

* This catalog contains the typical specification only due to the limitation of space. When you consider purchase of our products, please check our specification. For details of each product (characteristics graph, reliability information, precautions for use, and so on), see our Web site (<http://www.ty-top.com/>) or CD catalogs.