

- Qualified for Military Applications
- ESD Protection Exceeds 2000 V Per MIL-STD-883, Method 3015; Exceeds 200 V Using Machine Model (C = 200 pF, R = 0)
- Triple Supervisory Circuits for DSP and Processor-Based Systems
- Power-On Reset Generator with Fixed Delay Time of 200 ms, No External Capacitor Needed
- Temperature-Compensated Voltage Reference
- Maximum Supply Current of 40 μ A
- Supply Voltage Range . . . 2 V to 6 V
- Defined $\overline{\text{RESET}}$ Output from $V_{\text{DD}} \geq 1.1$ V
- CDIP-8 and LCCC-20 Packages
- Temperature Range . . . -55°C to 125°C

typical applications

Figure 1 lists some of the typical applications for the TPS3307 family, and a schematic diagram for a processor-based system application. This application uses TI part numbers TPS3307-18 and SMJ320C6201B.

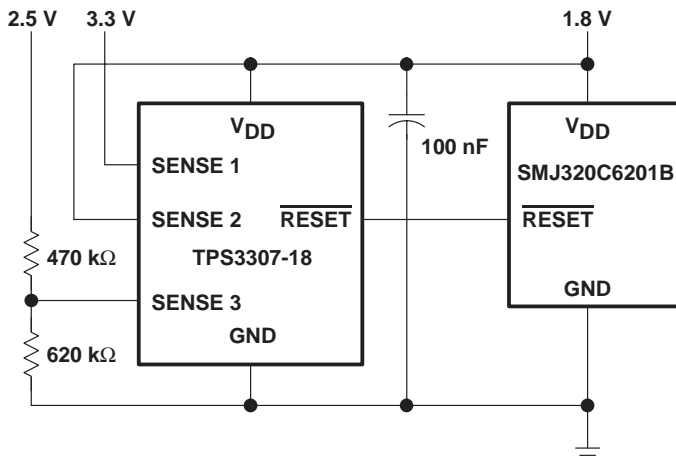

Figure 1. Applications Using the TPS3307-18

description

The TPS3307-18 is a micropower supply voltage supervisor designed for circuit initialization primarily in automotive DSP and processor-based systems, which require more than one supply voltage.

The TPS3307-18 is designed for monitoring three independent supply voltages: 3.3 V/1.8 V/adj,. The adjustable SENSE input allows the monitoring of any supply voltage >1.25 V.



Please be aware that an important notice concerning availability, standard warranty, and use in critical applications of Texas Instruments semiconductor products and disclaimers thereto appears at the end of this data sheet.

PRODUCTION DATA information is current as of publication date. Products conform to specifications per the terms of Texas Instruments standard warranty. Production processing does not necessarily include testing of all parameters.



POST OFFICE BOX 655303 • DALLAS, TEXAS 75265

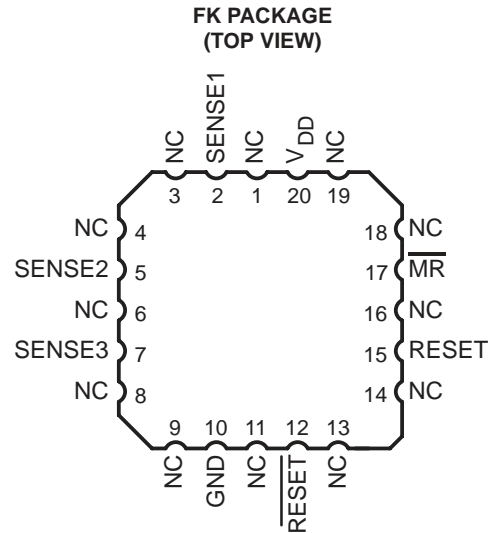
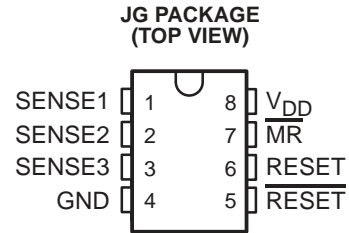

- Military applications using DSPs, Microcontrollers or Microprocessors
- Industrial Equipment
- Programmable Controls

Copyright © 2003, Texas Instruments Incorporated
On products compliant to MIL-PRF-38535, all parameters are tested unless otherwise noted. On all other products, production processing does not necessarily include testing of all parameters.

TPS3307-18M TRIPLE PROCESSOR SUPERVISORS

SGLS133A – JANUARY 2003 – REVISED DECEMBER 2003

description (continued)

The various supply voltage supervisors are designed to monitor the nominal supply voltage as shown in the following supply voltage monitoring table.

SUPPLY VOLTAGE MONITORING

DEVICE	NOMINAL SUPERVISED VOLTAGE			THRESHOLD VOLTAGE (TYP)		
	SENSE1	SENSE2	SENSE3	SENSE1	SENSE2	SENSE3
TPS3307-18	3.3 V	1.8 V	User defined	2.93 V	1.68 V	1.25 V†

† The actual sense voltage has to be adjusted by an external resistor divider according to the application requirements.

During power-on, $\overline{\text{RESET}}$ is asserted when the supply voltage V_{DD} becomes higher than 1.1 V. Thereafter, the supply voltage supervisor monitors the SENSEn inputs and keeps $\overline{\text{RESET}}$ active as long as SENSEn remain below the threshold voltage V_{IT+} .

An internal timer delays the return of the $\overline{\text{RESET}}$ output to the inactive state (high) to ensure proper system reset. The delay time, $t_{d\text{typ}} = 200$ ms, starts after all SENSEn inputs have risen above the threshold voltage V_{IT+} . When the voltage at any SENSE input drops below the threshold voltage V_{IT-} , the $\overline{\text{RESET}}$ output becomes active (low) again.

The TPS3307-18 incorporates a manual reset input, $\overline{\text{MR}}$. A low level at $\overline{\text{MR}}$ causes $\overline{\text{RESET}}$ to become active. In addition to the active-low $\overline{\text{RESET}}$ output, the TPS3307-18 includes an active-high RESET output.

ORDERING INFORMATION

TA	PACKAGE‡	ORDERABLE PART NUMBER	TOP-SIDE MARKING
-55°C to 125°C	Ceramic Dual In Line (JG)	TPS3307-18MJGB	TPS3307-18MJGB
	Leadless Ceramic Chip Carrier (FK)	TPS3307-18MFKB	TPS3307-18MFKB

‡ Package drawings, standard packing quantities, thermal data, symbolization, and PCB design guidelines are available at www.ti.com/sc/package.

FUNCTION/TRUTH TABLES

$\overline{\text{MR}}$	SENSE1 > V_{IT1}	SENSE2 > V_{IT2}	SENSE3 > V_{IT3}	$\overline{\text{RESET}}$	RESET
L	X	X	X	L	H
H	0	0	0	L	H
H	0	0	1	L	H
H	0	1	0	L	H
H	0	1	1	L	H
H	1	0	0	L	H
H	1	0	1	L	H
H	1	1	0	L	H
H	1	1	1	H	L

X = Don't care

functional block diagram

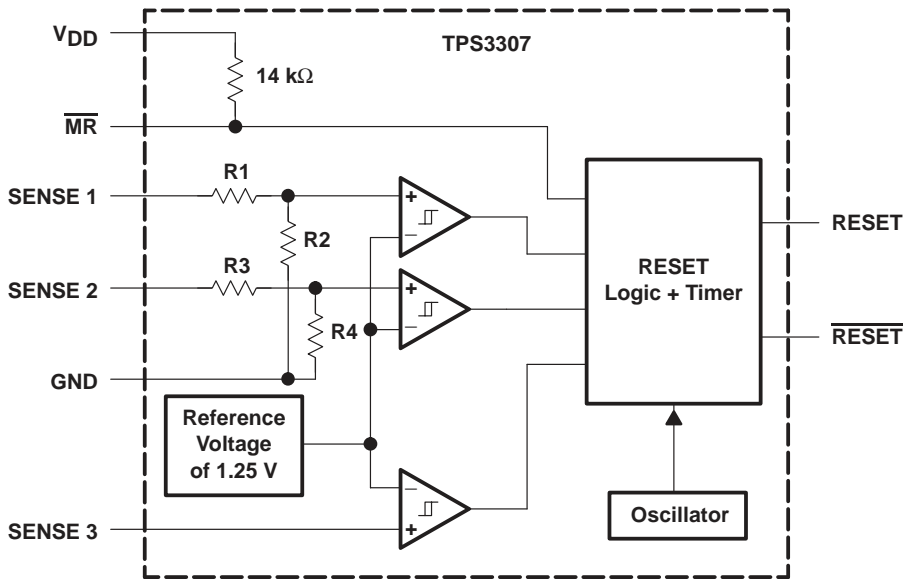

timing diagram

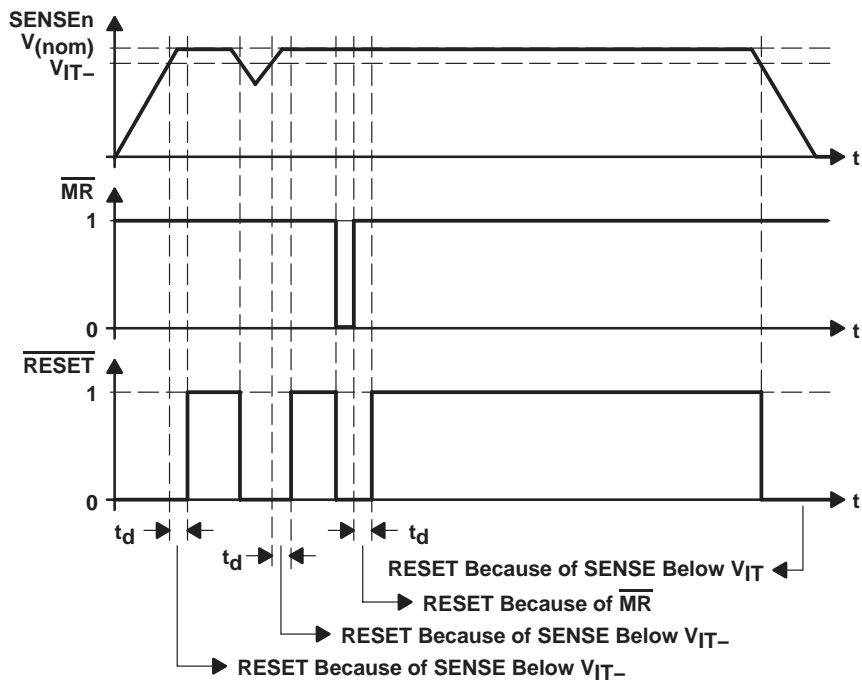

TPS3307-18M TRIPLE PROCESSOR SUPERVISORS

SGLS133A – JANUARY 2003 – REVISED DECEMBER 2003

absolute maximum ratings over operating free-air temperature range (unless otherwise noted)†

Supply voltage, V_{DD} (see Note1)	7 V
All other pins (see Note 1)	-0.3 V to 7 V
Maximum low output current, I_{OL}	5 mA
Maximum high output current, I_{OH}	-5 mA
Input clamp current, I_{IK} ($V_I < 0$ or $V_I > V_{DD}$)	± 20 mA
Output clamp current, I_{OK} ($V_O < 0$ or $V_O > V_{DD}$)	± 20 mA
Continuous total power dissipation	See Dissipation Rating Table
Operating free-air temperature range, T_A	-55°C to 125°C
Storage temperature range, T_{stg}	-65°C to 150°C
Soldering temperature	260°C

† Stresses beyond those listed under “absolute maximum ratings” may cause permanent damage to the device. These are stress ratings only, and functional operation of the device at these or any other conditions beyond those indicated under “recommended operating conditions” is not implied. Exposure to absolute-maximum-rated conditions for extended periods may affect device reliability.

NOTE 1: All voltage values are with respect to GND. For reliable operation the device must not be operated at 7 V for more than $t = 1000$ h continuously.

DISSIPATION RATING TABLE

PACKAGE	$T_A \leq 25^\circ\text{C}$ POWER RATING	DERATING FACTOR ABOVE $T_A = 25^\circ\text{C}$	$T_A = 70^\circ\text{C}$ POWER RATING	$T_A = 85^\circ\text{C}$ POWER RATING	$T_A = 125^\circ\text{C}$ POWER RATING
JG	1 W	6.25 mW/°C	719 mW	625 mW	375 mW
FK	1.39 W	11.58 mW/°C	869 mW	695 mW	232 mW

recommended operating conditions at specified temperature range

	MIN	MAX	UNIT
Supply voltage, V_{DD}	2	6	V
Input voltage at \overline{MR} and SENSE3, V_I	0	$V_{DD}+0.3$	V
Input voltage at SENSE1 and SENSE2, V_I	0	$(V_{DD}+0.3)V_{IT}/1.25V$	V
High-level input voltage at \overline{MR} , V_{IH}	$0.7 \times V_{DD}$		V
Low-level input voltage at \overline{MR} , V_{IL}	$0.3 \times V_{DD}$		V
Input transition rise and fall rate at \overline{MR} , $\Delta t/\Delta V$	50		ns/V
Operating free-air temperature range, T_A	-55	125	°C



electrical characteristics over recommended operating free-air temperature range (unless otherwise noted)

PARAMETER		TEST CONDITIONS	MIN	TYP	MAX	UNIT	
V _{OH}	High-level output voltage	V _{DD} = 2 V to 6 V, I _{OH} = -20 μA	V _{DD} - 0.2V			V	
		V _{DD} = 3.3 V, I _{OH} = -2 mA	V _{DD} - 0.4V				
		V _{DD} = 6 V, I _{OH} = -3 mA	V _{DD} - 0.4V				
V _{OL}	Low-level output voltage	V _{DD} = 2 V to 6 V, I _{OL} = 20 μA	0.2			V	
		V _{DD} = 3.3 V, I _{OL} = 2 mA	0.4				
		V _{DD} = 6 V, I _{OL} = 3 mA	0.4				
Power-up reset voltage (see Note 2)		V _{DD} ≥ 1.1 V, I _{OL} = 20 μA	0.4			V	
V _{IT-}	Negative-going input threshold voltage (see Note 3)	VSENSE3	V _{DD} = 2 V to 6 V	1.22	1.25	1.29	V
		VSENSE2		1.64	1.68	1.73	V
		VSENSE1		2.86	2.93	3.02	
V _{hys}	Hysteresis at VSENSEn input	V _{IT-} = 1.25 V	2	10	30	mV	
		V _{IT-} = 1.68 V	2	15	40		
		V _{IT-} = 2.93 V	3	30	60		
I _H	High-level input current	$\overline{\text{MR}}$	MR = 0.7 × V _{DD} , V _{DD} = 6 V		-130	-180	μA
		SENSE1	VSENSE1 = V _{DD} = 6 V		5	8	
		SENSE2	VSENSE2 = V _{DD} = 6 V		6	9	
		SENSE3	VSENSE3 = V _{DD}		-25	25	
I _L	Low-level input current	$\overline{\text{MR}}$	MR = 0 V, V _{DD} = 6 V		-430	-600	μA
		SENSEn	VSENSE1,2,3 = 0 V		-1	1	
I _{DD}	Supply current				40	μA	
C _i	Input capacitance	V _I = 0 V to V _{DD}		10		pF	

NOTES: 2. The lowest supply voltage at which RESET becomes active. t_r, V_{DD} ≥ 15 μs/V
 3. To ensure best stability of the threshold voltage, a bypass capacitor (ceramic 0.1 μF) should be placed close to the supply terminals.

TPS3307-18M

TRIPLE PROCESSOR SUPERVISORS

SGLS133A – JANUARY 2003 – REVISED DECEMBER 2003

timing requirements at $V_{DD} = 2\text{ V to }6\text{ V}$, $R_L = 1\text{ M}\Omega$, $C_L = 50\text{ pF}$, $T_A = 25^\circ\text{C}$

PARAMETER		TEST CONDITIONS	MIN	TYP	MAX	UNIT
t_w	Pulse width	$V_{SENSEnL} = V_{IT-} - 0.2\text{ V}$, $V_{SENSEnH} = V_{IT+} + 0.2\text{ V}$	6	10		μs
		$V_{IH} = 0.7 \times V_{DD}$, $V_{IL} = 0.3 \times V_{DD}$	100	150		ns

switching characteristics at $V_{DD} = 2\text{ V to }6\text{ V}$, $R_L = 1\text{ M}\Omega$, $C_L = 50\text{ pF}$, $T_A = 25^\circ\text{C}$

PARAMETER		TEST CONDITIONS	MIN	TYP	MAX	UNIT
t_d	Delay time	$V_I(\text{SENSEn}) \geq V_{IT+} + 0.2\text{ V}$, $\overline{\text{MR}} \geq 0.7 \times V_{DD}$. See timing diagram	140	200	280	ms
t_{PHL}	Propagation (delay) time, high-to-low level output	$\overline{\text{MR}}$ to $\overline{\text{RESET}}$ $\overline{\text{MR}}$ to $\overline{\text{RESET}}$		200	600	ns
t_{PLH}	Propagation (delay) time, low-to-high level output	$\overline{\text{MR}}$ to $\overline{\text{RESET}}$ $\overline{\text{MR}}$ to $\overline{\text{RESET}}$				
t_{PHL}	Propagation (delay) time, high-to-low level output	SENSEn to $\overline{\text{RESET}}$		1	5	μs
t_{PLH}	Propagation (delay) time, low-to-high level output	SENSEn to $\overline{\text{RESET}}$				



TYPICAL CHARACTERISTICS

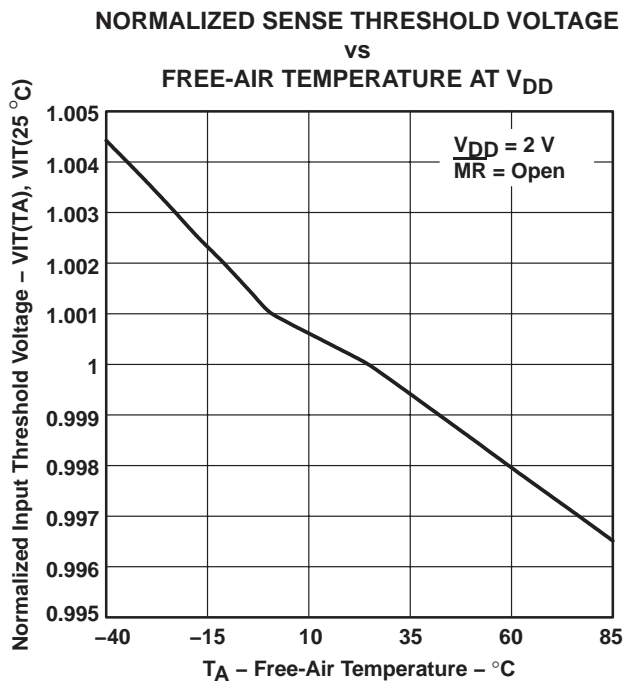

Figure 2

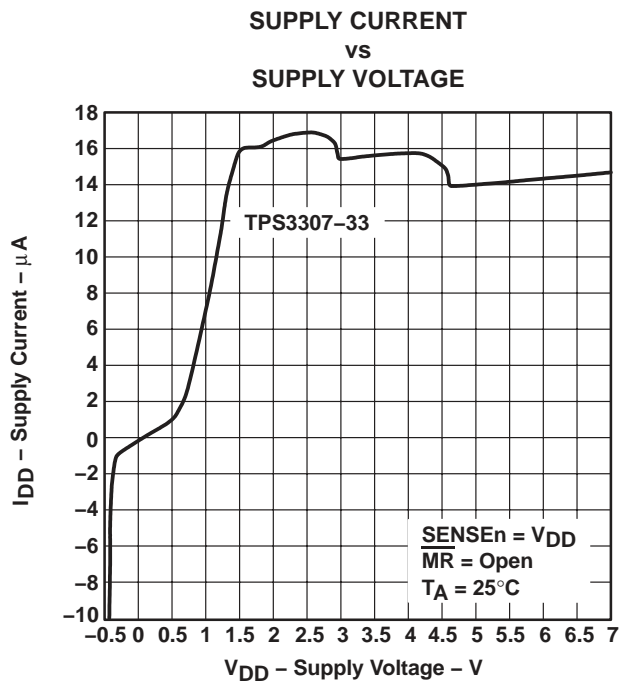

Figure 3

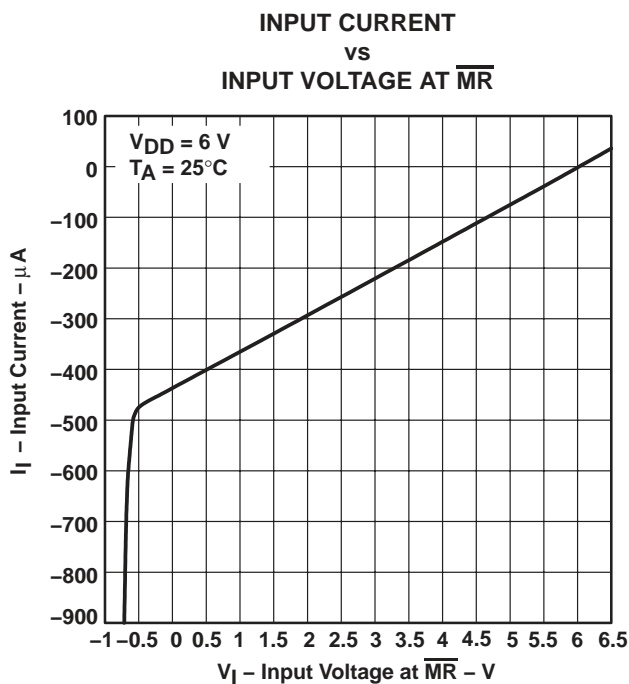

Figure 4

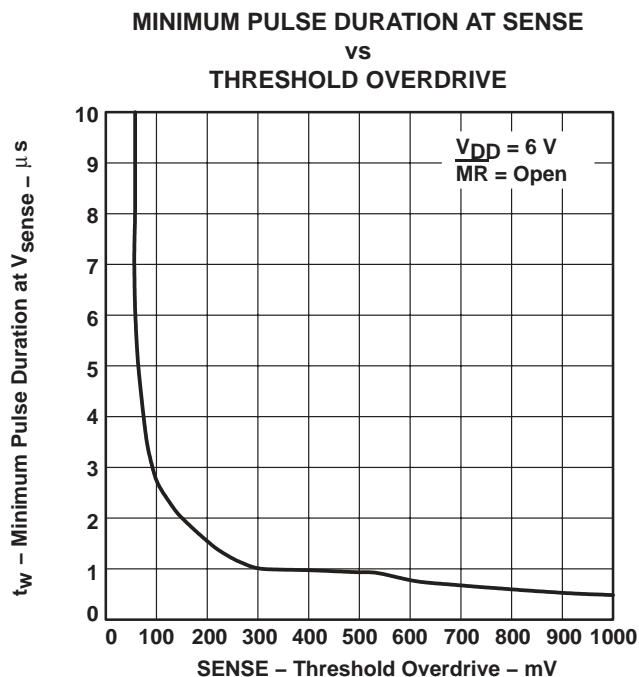

Figure 5

TYPICAL CHARACTERISTICS

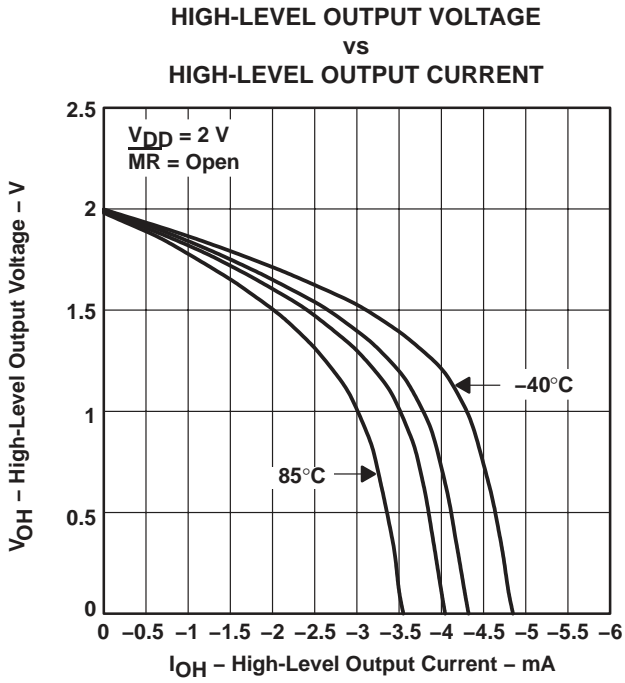

Figure 6

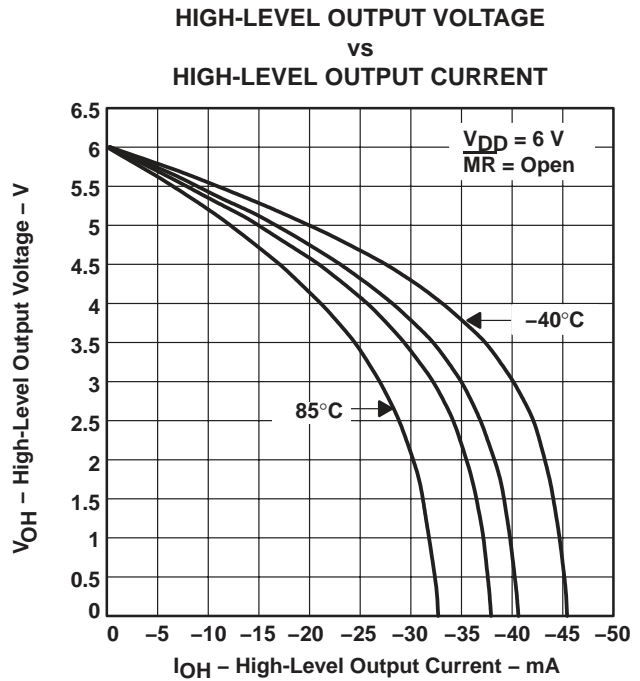

Figure 7

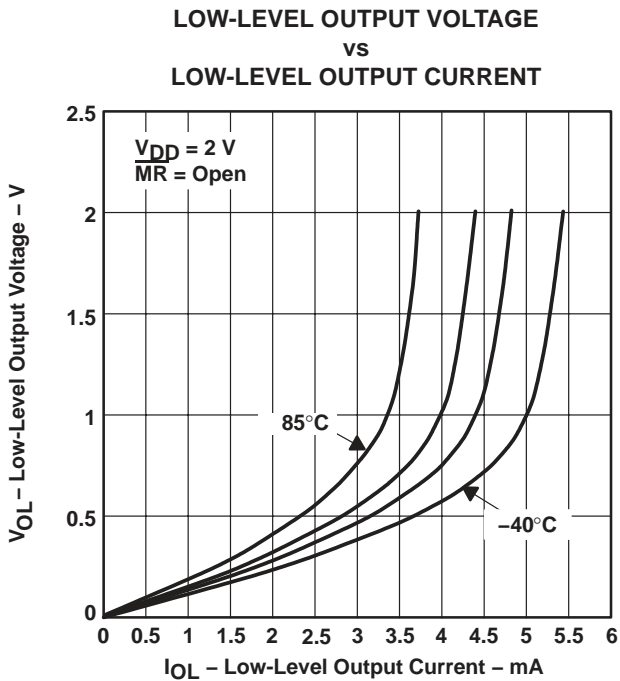

Figure 8

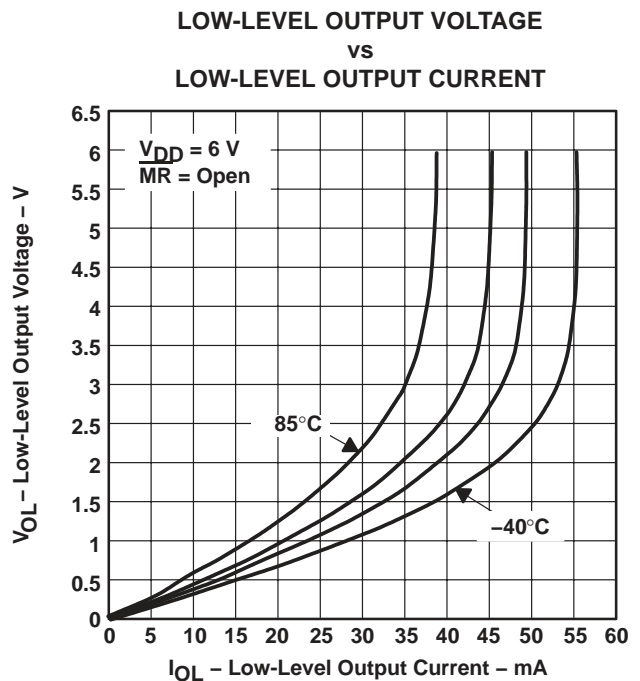

Figure 9

PACKAGING INFORMATION

Orderable Device	Status (1)	Package Type	Package Drawing	Pins	Package Qty	Eco Plan (2)	Lead finish/ Ball material (6)	MSL Peak Temp (3)	Op Temp (°C)	Device Marking (4/5)	Samples
5962-9959101Q2A	ACTIVE	LCCC	FK	20	1	Non-RoHS & Green	SNPB	N / A for Pkg Type	-55 to 125	5962-9959101Q2A TPS3307-18MFKB	Samples
5962-9959101QPA	ACTIVE	CDIP	JG	8	1	Non-RoHS & Green	SNPB	N / A for Pkg Type	-55 to 125	9959101QPA TPS3307-18M	Samples
TPS3307-18MFKB	ACTIVE	LCCC	FK	20	1	Non-RoHS & Green	SNPB	N / A for Pkg Type	-55 to 125	5962-9959101Q2A TPS3307-18MFKB	Samples
TPS3307-18MJGB	ACTIVE	CDIP	JG	8	1	Non-RoHS & Green	SNPB	N / A for Pkg Type	-55 to 125	9959101QPA TPS3307-18M	Samples

(1) The marketing status values are defined as follows:

ACTIVE: Product device recommended for new designs.

LIFEBUY: TI has announced that the device will be discontinued, and a lifetime-buy period is in effect.

NRND: Not recommended for new designs. Device is in production to support existing customers, but TI does not recommend using this part in a new design.

PREVIEW: Device has been announced but is not in production. Samples may or may not be available.

OBSOLETE: TI has discontinued the production of the device.

(2) **RoHS:** TI defines "RoHS" to mean semiconductor products that are compliant with the current EU RoHS requirements for all 10 RoHS substances, including the requirement that RoHS substance do not exceed 0.1% by weight in homogeneous materials. Where designed to be soldered at high temperatures, "RoHS" products are suitable for use in specified lead-free processes. TI may reference these types of products as "Pb-Free".

RoHS Exempt: TI defines "RoHS Exempt" to mean products that contain lead but are compliant with EU RoHS pursuant to a specific EU RoHS exemption.

Green: TI defines "Green" to mean the content of Chlorine (Cl) and Bromine (Br) based flame retardants meet JS709B low halogen requirements of <=1000ppm threshold. Antimony trioxide based flame retardants must also meet the <=1000ppm threshold requirement.

(3) MSL, Peak Temp. - The Moisture Sensitivity Level rating according to the JEDEC industry standard classifications, and peak solder temperature.

(4) There may be additional marking, which relates to the logo, the lot trace code information, or the environmental category on the device.

(5) Multiple Device Markings will be inside parentheses. Only one Device Marking contained in parentheses and separated by a "~" will appear on a device. If a line is indented then it is a continuation of the previous line and the two combined represent the entire Device Marking for that device.

(6) Lead finish/Ball material - Orderable Devices may have multiple material finish options. Finish options are separated by a vertical ruled line. Lead finish/Ball material values may wrap to two lines if the finish value exceeds the maximum column width.

Important Information and Disclaimer:The information provided on this page represents TI's knowledge and belief as of the date that it is provided. TI bases its knowledge and belief on information provided by third parties, and makes no representation or warranty as to the accuracy of such information. Efforts are underway to better integrate information from third parties. TI has taken and continues to take reasonable steps to provide representative and accurate information but may not have conducted destructive testing or chemical analysis on incoming materials and chemicals. TI and TI suppliers consider certain information to be proprietary, and thus CAS numbers and other limited information may not be available for release.

In no event shall TI's liability arising out of such information exceed the total purchase price of the TI part(s) at issue in this document sold by TI to Customer on an annual basis.

OTHER QUALIFIED VERSIONS OF TPS3307-18M :

- Automotive : [TPS3307-18-Q1](#)
- Enhanced Product : [TPS3307-EP](#)

NOTE: Qualified Version Definitions:

- Automotive - Q100 devices qualified for high-reliability automotive applications targeting zero defects
- Enhanced Product - Supports Defense, Aerospace and Medical Applications

TUBE

*All dimensions are nominal

Device	Package Name	Package Type	Pins	SPQ	L (mm)	W (mm)	T (μm)	B (mm)
5962-9959101Q2A	FK	LCCC	20	1	506.98	12.06	2030	NA
TPS3307-18MFKB	FK	LCCC	20	1	506.98	12.06	2030	NA

GENERIC PACKAGE VIEW

FK 20

LCCC - 2.03 mm max height

8.89 x 8.89, 1.27 mm pitch

LEADLESS CERAMIC CHIP CARRIER

This image is a representation of the package family, actual package may vary.
Refer to the product data sheet for package details.

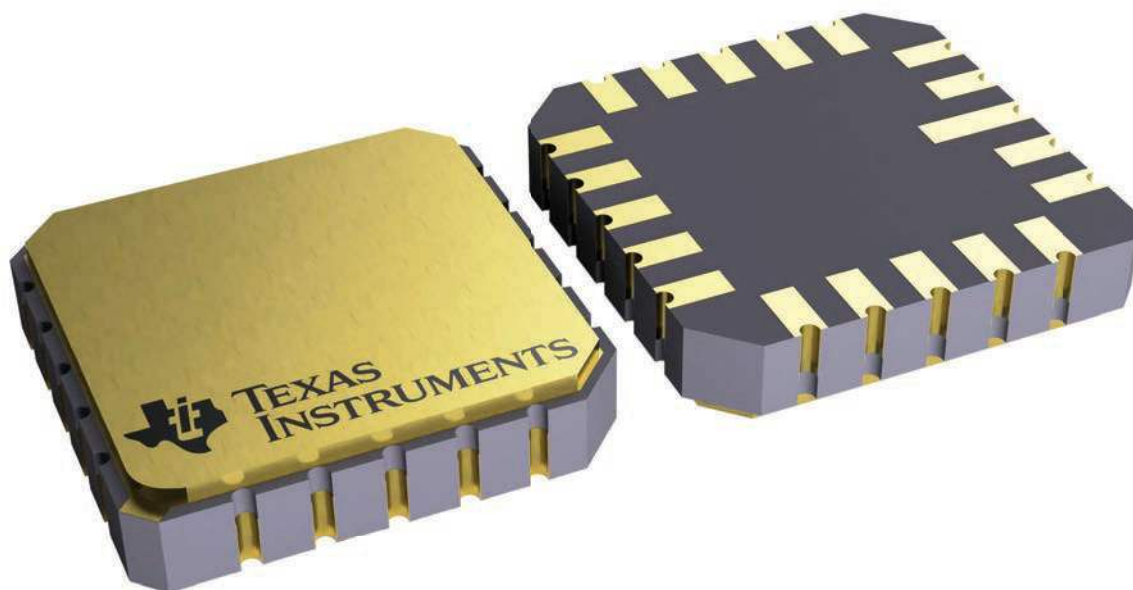

4229370VA\

JG (R-GDIP-T8)

CERAMIC DUAL-IN-LINE

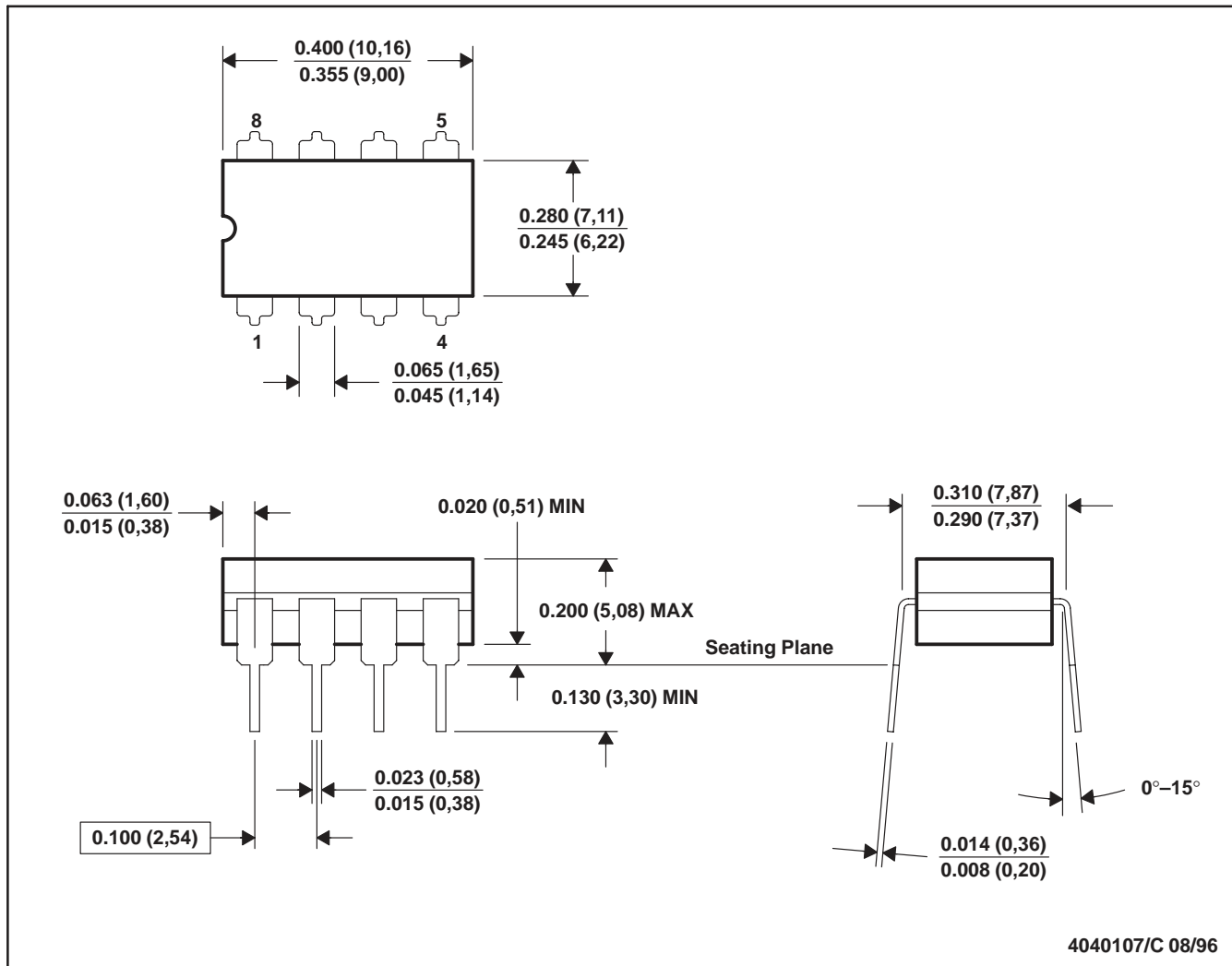

- NOTES: A. All linear dimensions are in inches (millimeters).
 B. This drawing is subject to change without notice.
 C. This package can be hermetically sealed with a ceramic lid using glass frit.
 D. Index point is provided on cap for terminal identification.
 E. Falls within MIL STD 1835 GDIP1-T8

IMPORTANT NOTICE AND DISCLAIMER

TI PROVIDES TECHNICAL AND RELIABILITY DATA (INCLUDING DATA SHEETS), DESIGN RESOURCES (INCLUDING REFERENCE DESIGNS), APPLICATION OR OTHER DESIGN ADVICE, WEB TOOLS, SAFETY INFORMATION, AND OTHER RESOURCES "AS IS" AND WITH ALL FAULTS, AND DISCLAIMS ALL WARRANTIES, EXPRESS AND IMPLIED, INCLUDING WITHOUT LIMITATION ANY IMPLIED WARRANTIES OF MERCHANTABILITY, FITNESS FOR A PARTICULAR PURPOSE OR NON-INFRINGEMENT OF THIRD PARTY INTELLECTUAL PROPERTY RIGHTS.

These resources are intended for skilled developers designing with TI products. You are solely responsible for (1) selecting the appropriate TI products for your application, (2) designing, validating and testing your application, and (3) ensuring your application meets applicable standards, and any other safety, security, regulatory or other requirements.

These resources are subject to change without notice. TI grants you permission to use these resources only for development of an application that uses the TI products described in the resource. Other reproduction and display of these resources is prohibited. No license is granted to any other TI intellectual property right or to any third party intellectual property right. TI disclaims responsibility for, and you will fully indemnify TI and its representatives against, any claims, damages, costs, losses, and liabilities arising out of your use of these resources.

TI's products are provided subject to [TI's Terms of Sale](#) or other applicable terms available either on [ti.com](https://www.ti.com) or provided in conjunction with such TI products. TI's provision of these resources does not expand or otherwise alter TI's applicable warranties or warranty disclaimers for TI products.

TI objects to and rejects any additional or different terms you may have proposed.

Mailing Address: Texas Instruments, Post Office Box 655303, Dallas, Texas 75265
Copyright © 2023, Texas Instruments Incorporated