



a module solution provider

ZB7412-00

**SimpleLink™ Bluetooth® Low Energy
Wireless MCU Module**

TI CC2640R2F Solution

Datasheet

Revision 0.4

Prepared By	Reviewed By	Approved By
Victor Lee Feb/15/2019	Austin Feng Feb/15/2019	[Signature] 2/15/2019

Index

1. OVERVIEW	3
1.1. GENERAL FEATURES	3
1.2. APPLICATIONS.....	4
2. FUNCTIONAL FEATURES	6
2.1. MODULE BLOCK DIAGRAM.....	6
2.2. BLOCK FUNCTIONAL FEATURE	7
Microcontroller	7
Ultra-Low Power Sensor Controller	7
Peripherals	7
RF Section	8
3. MODULE OUTLINE.....	9
3.1. SIGNAL LAYOUT (TOP VIEW).....	9
3.2. PIN DESCRIPTION	10
4. MODULE SPECIFICATIONS	12
4.1. ABSOLUTE MAXIMUM RATINGS ⁽¹⁾⁽²⁾	12
4.2. ESD RATINGS	12
4.3. RECOMMENDED OPERATING CONDITIONS	13
4.4. POWER CONSUMPTION SUMMARY	14
4.5. GENERAL CHARACTERISTICS.....	15
4.6. 125-KBPS CODED (BLUETOOTH 5) – RX.....	15
4.7. 125-KBPS CODED (BLUETOOTH 5) – TX.....	16
4.8. 500-KBPS CODED (BLUETOOTH 5) – RX.....	17
4.9. 500-KBPS CODED (BLUETOOTH 5) – TX.....	18
4.10. 1-MBPS GFSK (BLUETOOTH LOW ENERGY) – RX.....	18
4.11. 1-MBPS GFSK (BLUETOOTH LOW ENERGY) – TX.....	20
4.12. 2-MBPS GFSK (BLUETOOTH 5) – RX.....	20
4.13. 2-MBPS GFSK (BLUETOOTH 5) – TX.....	21
4.14. INTERNAL 24-MHZ CRYSTAL OSCILLATOR (XOSC_HF) ⁽¹⁾	21
4.15. 32.768-KHZ CRYSTAL OSCILLATOR (XOSC_LF).....	22
4.16. 48-MHZ RC OSCILLATOR (RCOSC_HF)	22
4.17. 32-KHZ RC OSCILLATOR (RCOSC_LF)	22
4.18. ADC CHARACTERISTICS ⁽¹⁾	23
4.19. TEMPERATURE SENSOR.....	24

4.20. BATTERY MONITOR.....	25
4.21. CONTINUOUS TIME COMPARATOR	25
4.22. LOW-POWER CLOCKED COMPARATOR.....	25
4.23. PROGRAMMABLE CURRENT SOURCE	26
4.24. DC CHARACTERISTICS.....	26
4.25. TIMING REQUIREMENTS.....	27
4.26. SWITCHING CHARACTERISTICS	28
4.27. TYPICAL CHARACTERISTICS.....	30
4.28. CHIP ANTENNA CHARACTERISTICS.....	31
5. DESIGN RECOMMENDATIONS.....	33
5.1. MODULE LAYOUT RECOMMENDATIONS	33
5.2. REFERENCE SCHEMATIC	35
6. PACKAGE INFORMATION.....	36
6.1. MODULE MECHANICAL OUTLINE.....	36
6.2. ORDERING INFORMATION.....	37
6.3. PACKAGE MARKING	38
7. SMT AND BAKING RECOMMENDATION	40
7.1. BAKING RECOMMENDATION	40
7.2. SMT RECOMMENDATION	40
8. TAPE REEL INFORMATION	42
8.1. COVER / CARRIER TAPE DIMENSION	42
9. REGULATORY INFORMATION	43
9.1. UNITED STATES	43
9.2. CANADA	44
9.3. EUROPE.....	45
9.4. JAPAN	45
9.5. TAIWAN.....	46
9.6. AUSTRALIA/NEW ZEALAND	47
10. HISTORY CHANGE	48

1. OVERVIEW

The certified ZB7412-00 module from JORJIN is a wireless MCU module targeting Bluetooth 4.2 and Bluetooth 5 low energy applications. This module is based on TI CC2640R2F wireless MCU QFN-32 package chip.

The module is a cost-effective, ultralow power, 2.4-GHz RF devices. Very low active RF and MCU current and low-power mode current consumption provide excellent battery lifetime and allow for operation on small coin cell batteries and in energy-harvesting applications.

1.1. General Features

- TI CC2640R2F, 24MHz & 32.768KHz crystals, DC2DC, and chip antenna on a single module.
- Built-in TI CC2640R2F 5x5mm RHB VQFN32 (15 GPIOs)
- LGA 25pins package.
- Dimension 16.9mm(L) x 11mm(W) x 2.45mm(H)
- Powerful ARM® Cortex®-M3 Microcontroller
- Ultra-Low Power Sensor Controller
- Efficient Code Size Architecture, Placing Drivers, TI-RTOS, and Bluetooth® Software in ROM to Make More Flash Available for the Application
- No external component required.
- Low Power and Wide Supply Voltage Range: 1.8 to 3.8V
 - Internal DC-DC converter built-in
- 2.4-GHz RF Transceiver and Integrated Antenna.
- RoHS Compliance
- Suitable for Systems Targeting Compliance With Worldwide Radio Frequency Regulations
 - ETSI EN 300 328 (Europe)
 - FCC CFR47 Part 15 (US)
 - IC RSS-247 (Canada)
 - ARIB STD-T66 (Japan)
 - NCC LP0002 (Taiwan)
 - AS/NZS 4268 (Australia/New Zealand)
 - KN 301 489 (South Korea)
- Tools and Development Environment from TI
 - Full-Feature and Low-Cost Development Kits
 - Packet Sniffer PC Software

- Sensor Controller Studio
- SmartRF™ Studio
- SmartRF Flash Programmer 2
- IAR Embedded Workbench® for ARM
- Code Composer Studio™

1.2. Applications

- Home and Building Automation
 - Connected Appliances
 - Lighting
 - Locks
 - Gateways
 - Security Systems
- Industrial
 - Logistics
 - Production and Manufacturing Automation
 - Asset Tracking and Management
 - HMI and Remote Display
 - Access Control
- Retail
 - Beacons
 - Advertising
 - ESL and Price Tags
 - Point of Sales and Payment Systems
- Health and Medical
 - Thermometers
 - Blood Glucose and Pressure Meters
 - Weight Scales
 - Hearing Aids
- Sports and Fitness
 - Activity Monitors and Fitness Trackers
 - Heart Rate Monitors
 - Running and Biking Sensors
 - Sports Watches
 - Gym Equipment
 - Team Sports Equipment

- HID
 - Voice Remote Controls
 - Gaming
 - Keyboards and Mice

JORJIN CONFIDENTIAL

2. FUNCTIONAL FEATURES

2.1. Module Block Diagram

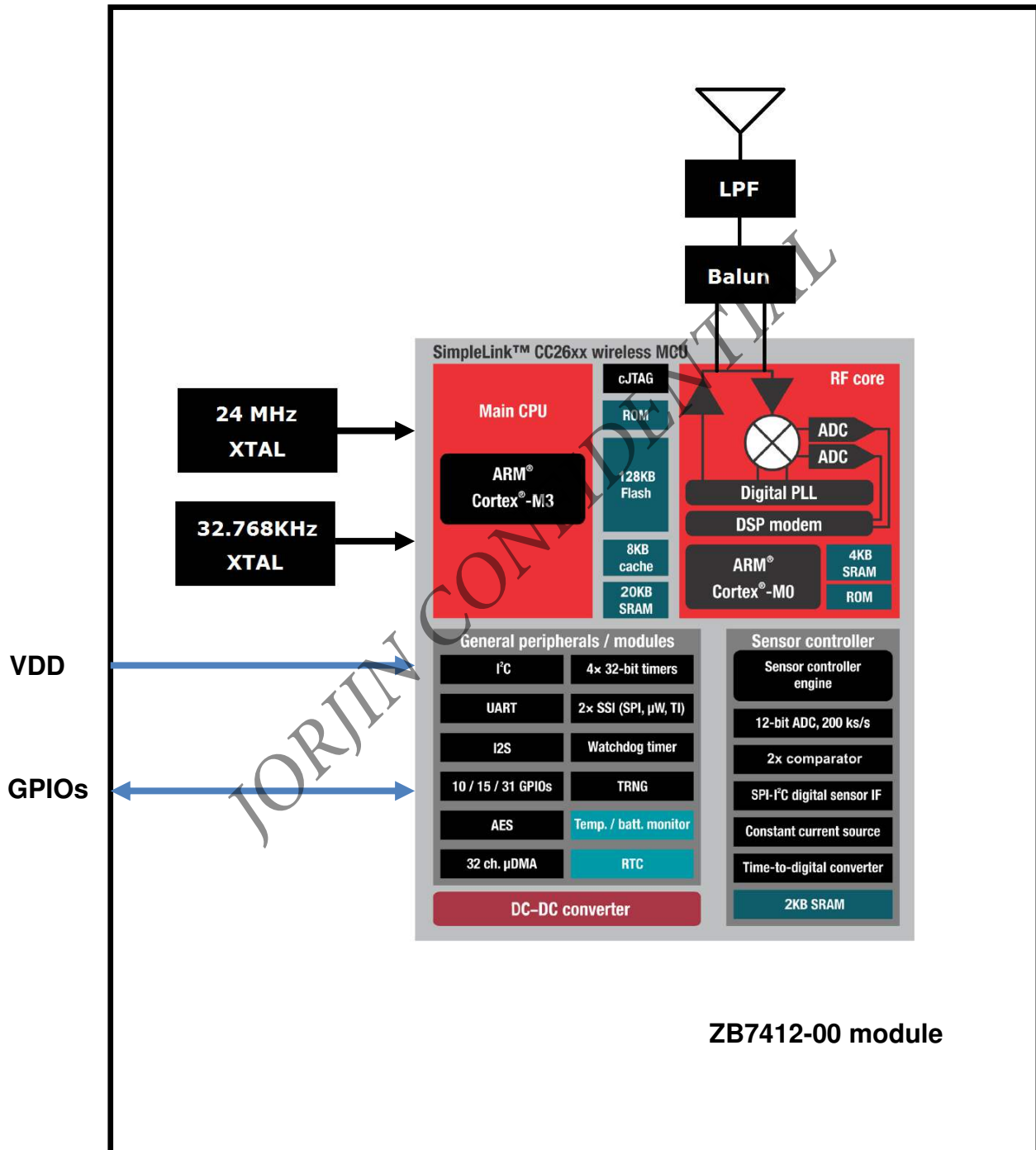

2.2. Block Functional Feature

Microcontroller

- Powerful ARM® Cortex®-M3
- EEMBC CoreMark® score: 142
- Up to 48-MHz Clock Speed
- 275KB of Nonvolatile Memory Including 128KB of In-System Programmable Flash
- Up to 28KB of System SRAM, of Which 20KB is Ultra-Low Leakage SRAM
- 8-KB SRAM for Cache or System RAM Use
- 2-Pin cJTAG and JTAG Debugging
- Supports Over-The-Air Upgrade (OTA)

Ultra-Low Power Sensor Controller

- Can run autonomous from the rest of the system
- 16-Bit Architecture
- 2-KB Ultra-Low Leakage SRAM for Code and Data

Peripherals

- All Digital Peripheral Pins can be routed to any GPIO.
- 15 GPIOs
- 4 General-Purpose Timer Modules (Eight 16-Bit or Four 32-Bit Timer, PWM Each)
- 12-Bit ADC, 200-ksamples/s, 8-Channel Analog MUX
- Continuous Time Comparator
- Ultra-Low Power Analog Comparator
- Programmable Current Source
- UART
- 2x SSI (SPI, MICROWIRE, TI)
- I2C
- I2S
- Real-Time Clock (RTC)

- AES-128 Security Module
- True Random Number Generator (TRNG)
- Support for 8 Capacitive Sensing Buttons
- Integrated Temperature Sensor

RF Section

- 2.4 GHz RF Transceiver Compatible With *Bluetooth* Low Energy (BLE) 4.2 and 5 specifications
- Excellent Receiver Sensitivity (−96 dBm for BLE), Selectivity, and Blocking Performance
- Link budget of 101 dB for BLE.
- Programmable Output Power up to +5 dBm
- Integrated Antenna
- Pre-certified for Compliance With Worldwide Radio Frequency Regulations
 - ETSI (Europe)
 - IC (Canada)
 - FCC (USA)
 - ARIB STD-T66 (Japan)
 - NCC (Taiwan)
 - RCM (Australia and New Zealand)
 - KC (South Korea)

JORJIN CONFIDENTIAL

3. MODULE OUTLINE

3.1. Signal Layout (Top View)

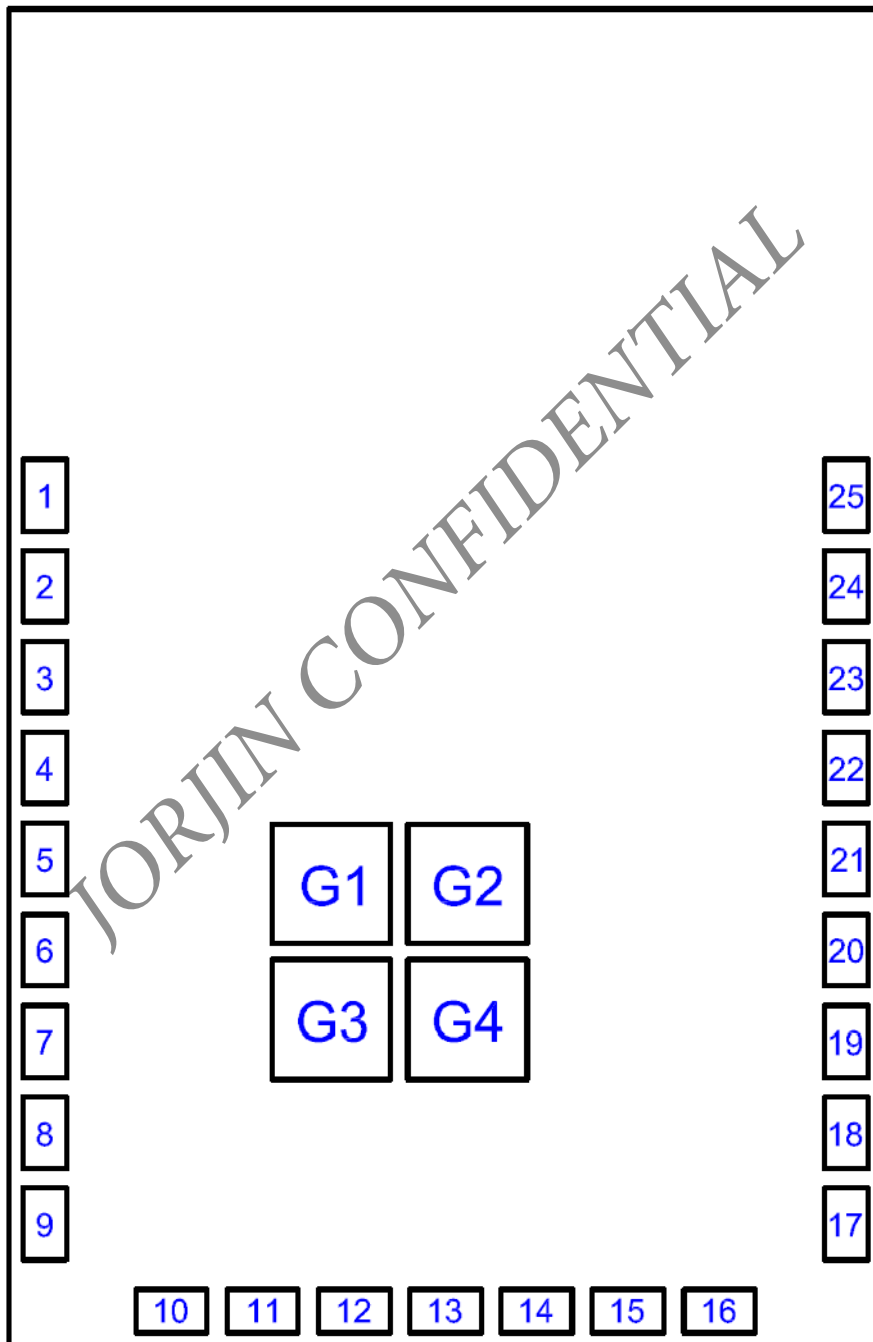

3.2. Pin Description

Table 3-1. Pin Description

Pin No.	Pin Name	Type	Description
1	GND	GND	GND
2	NC	NC	No connection. For internal test only.
3	GND	GND	GND
4	DIO_0	Digital I/O	GPIO, Sensor Controller
5	DIO_1	Digital I/O	GPIO, Sensor Controller
6	DIO_2	Digital I/O	GPIO, Sensor Controller, High drive capability
7	DIO_3	Digital I/O	GPIO, Sensor Controller, High drive capability
8	DIO_4	Digital I/O	GPIO, Sensor Controller, High drive capability
9	JTAG_TMSC	Digital I/O	JTAG_TMSC, High drive capability
10	JTAG_TCKC	Digital I/O	JTAG_TCKC
11	DIO_5	Digital I/O	GPIO, High drive capability, JTAG_TDO
12	DIO_6	Digital I/O	GPIO, High drive capability, JTAG_TDI
13	RESET_N	Digital Input	Reset, active-low. No internal pullup. Built-in 0.1uF capacitor to GND.
14	DIO_7	Digital/Analog I/O	GPIO, Sensor Controller, Analog
15	DIO_8	Digital/Analog I/O	GPIO, Sensor Controller, Analog
16	DIO_9	Digital/Analog I/O	GPIO, Sensor Controller, Analog. In -04 module, DIO_9 pin is connected to CS# pin of internal serial SPI Flash.
17	DIO_10	Digital/Analog I/O	GPIO, Sensor Controller, Analog. In -04 module, DIO_10 pin is connected to SCLK pin of internal serial SPI Flash.
18	DIO_11	Digital/Analog I/O	GPIO, Sensor Controller, Analog. In -04 module, DIO_11 pin is connected to SI pin of internal serial SPI Flash.
19	DIO_12	Digital/Analog I/O	GPIO, Sensor Controller, Analog. In -04 module, DIO_12 pin is connected to SO pin of internal Serial SPI Flash.
20	DIO_13	Digital/Analog I/O	GPIO, Sensor Controller, Analog

21	DIO_14	Digital/Analog I/O	GPIO, Sensor Controller, Analog
22	VDDS	Power	1.8 V to 3.8 V main chip and DC/DC supply
23	VDDS2	Power	1.8 V to 3.8 V GPIO supply
24	NC	NC	No connection.
25	GND	GND	Ground
G1~G4	GND	GND	Ground

JORJIN CONFIDENTIAL

4. MODULE SPECIFICATIONS

4.1. Absolute Maximum Ratings⁽¹⁾⁽²⁾

over operating free-air temperature range (unless otherwise noted)

Parameter	Conditions	MIN	MAX	Unit
Supply voltage, VDD5 ⁽³⁾		-0.3	4.1	V
Voltage on any digital pin ⁽⁴⁾		-0.3	VDD5+0.3 Max 4.1	V
Voltage on ADC input (V_{in})	Voltage scaling enabled	-0.3	VDD5	V
	Internal reference, voltage scaling disabled	-0.3	1.49	V
	VDD5 as reference, voltage scaling disabled	-0.3	VDD5/2.9	V
Input RF level			+5	dBm
Storage temperature range		-40	+85	°C

- (1) All voltage values are with respect to ground, unless otherwise noted.
- (2) Stresses beyond those listed under Absolute Maximum Ratings may cause permanent damage to the device. These are stress ratings only, and functional operation of the device at these or any other conditions beyond those indicated under Recommended Operating Conditions is not implied. Exposure to absolute-maximum-rated conditions for extended periods may affect device reliability.
- (3) VDD5 must be at the same potential as VDD5.
- (4) Including analog capable DIO.

4.2. ESD Ratings

Parameter		Value	Unit
Electrostatic discharge performance (V_{ESD})	Human Body Model (HBM), per ANSI/ESDA/JEDEC JS001 ⁽¹⁾	All pins	±2500 V
	Charged Device Model (CDM), per JESD22-C101 ⁽²⁾	RF pins	±750 V
		Non-RF pins	±750 V

- (1) JEDEC document JEP155 states that 500-V HBM allows safe manufacturing with a standard ESD control process.
- (2) JEDEC document JEP157 states that 250-V CDM allows safe manufacturing with a standard ESD control process.

4.3. Recommended Operating Conditions

Parameter	Conditions	MIN	MAX	Unit
Ambient temperature range		-40	85	°C
Operating supply voltage (VDD5)	For operation in battery-powered and 3.3 V systems	1.8	3.8	V

JORJIN CONFIDENTIAL

4.4. Power Consumption Summary

Tc = 25°C, VDD5 = 3.0 V with internal DC-DC converter, unless otherwise noted.

Parameter		Test Conditions	Min	Typ	Max	Units
I _{core}	Core current consumption	Reset. RESET_N pin asserted or VDD5 below Power-on-Reset threshold		100		nA
		Shutdown. No clocks running, no retention		150		nA
		Standby. With RTC, CPU, RAM and (partial) register retention. RCOSC_LF		1.1		μA
		Standby. With RTC, CPU, RAM and (partial) register retention. XOSC_LF		1.3		μA
		Standby. With Cache, RTC, CPU, RAM and (partial) register retention. RCOSC_LF		2.8		μA
		Standby. With Cache, RTC, CPU, RAM and (partial) register retention. XOSC_LF		3.0		μA
		Idle. Supply Systems and RAM powered		550		μA
		Active. Core running CoreMark		1.45mA + 31uA/MHz		
		Radio RX		6.2		mA
		Radio TX, 0 dBm output power		6.8		
		Radio TX, 5 dBm output power		9.4		mA
I _{peri}	Peripheral Current Consumption (Adds to core current I _{core} for each peripheral unit activated) ⁽¹⁾					
	Peripheral power domain	Delta current with domain enabled		20		μA
	Serial power domain	Delta current with domain enabled		13		μA
	RF Core	Delta current with power domain enabled, clock enabled, RF Core Idle		237		μA
	μ DMA	Delta current with clock enabled, module idle		130		μA
	Timers	Delta current with clock enabled, module idle		113		μA
	I2C	Delta current with clock enabled, module idle		12		μA
	I2S	Delta current with clock enabled, module idle		36		μA
	SSI	Delta current with clock enabled, module idle		93		μA
	UART	Delta current with clock enabled, module idle		164		μA

(1) I_{peri} is not supported in standby or shutdown modes.

4.5. General Characteristics

Tc = 25°C, VDD5 = 3.0 V, unless otherwise noted.

Parameter	Test Conditions	Min	Typ	Max	Units
FLASH MEMORY					
Supported flash erase cycles before failure		100			K Cycles
Flash page/sector erase current	Average delta current		12.6		mA
Flash page/sector erase time ⁽¹⁾			8		ms
Flash page/sector size			4		KB
Flash write current	Average delta current, 4 bytes at a time		8.15		mA
Flash write time ⁽¹⁾	4 bytes at a time		8		μs
Flash page/sector erase time ⁽¹⁾			8		ms

(1) This number is dependent on Flash aging and will increase over time and erase cycles

4.6. 125-kbps Coded (Bluetooth 5) – RX

RF performance is specified in a single ended 50 ohm reference plane at the antenna feeding point with Tc = 25°C, VDD5 = 3.0 V, f_{RF} = 2440 MHz, unless otherwise noted.

Parameter	Test Conditions	Min	Typ	Max	Units
Receiver sensitivity	BER = 10 ⁻³		-102		dBm
Receiver saturation	BER = 10 ⁻³		>5		dBm
Frequency error tolerance	Difference between the incoming carrier frequency and the internally generated carrier frequency	-260		310	kHz
Data rate error tolerance	Difference between incoming data rate and the internally generated data rate (37-byte packets)	-260		260	ppm
Data rate error tolerance	Difference between incoming data rate and the internally generated data rate (255-byte packets)	-140		150	ppm
Co-channel rejection ⁽¹⁾	Wanted signal at -79 dBm, modulated interferer in channel, BER = 10 ⁻³		-3		dB
Selectivity, ±1 MHz ⁽¹⁾	Wanted signal at -79 dBm, modulated interferer at ±1 MHz, BER = 10 ⁻³		9 / 5 ⁽²⁾		dB
Selectivity, ±2 MHz ⁽¹⁾	Wanted signal at -79 dBm, modulated interferer at ±2 MHz, BER = 10 ⁻³		43/32 ⁽²⁾		dB
Selectivity, ±3 MHz ⁽¹⁾	Wanted signal at -79 dBm, modulated interferer at ±3 MHz, BER = 10 ⁻³		47/42 ⁽²⁾		dB

Selectivity, ± 4 MHz ⁽¹⁾	Wanted signal at -79 dBm, modulated interferer at ± 4 MHz, BER = 10^{-3}		46/47 ⁽²⁾		dB
Selectivity, ± 6 MHz ⁽¹⁾	Wanted signal at -79 dBm, modulated interferer at ± 6 MHz, BER = 10^{-3}		49/46 ⁽²⁾		dB
Alternate channel rejection, ± 7 MHz ⁽¹⁾	Wanted signal at -79 dBm, modulated interferer at $\geq \pm 7$ MHz, BER = 10^{-3}		50/47 ⁽²⁾		dB
Selectivity, Image frequency ⁽¹⁾	Wanted signal at -79 dBm, modulated interferer at image frequency, BER = 10^{-3}		32		dB
Selectivity, Image frequency ± 1 MHz ⁽¹⁾	Note that Image frequency +1 MHz is the Co-channel -1 MHz. Wanted signal at -79 dBm, modulated interferer at ± 1 MHz from image frequency, BER = 10^{-3}		5/32 ⁽²⁾		dB
Blocker rejection, ± 8 MHz and above ⁽¹⁾	Wanted signal at -79 dBm, modulated interferer at ± 8 MHz and above, BER = 10^{-3}		>46		
Out-of-band blocking ⁽³⁾	30 MHz to 2000 MHz		-40		dBm
Out-of-band blocking	2003 MHz to 2399 MHz		-19		dBm
Out-of-band blocking	2484 MHz to 2997 MHz		-22		dBm
Intermodulation	Wanted signal at 2402 MHz, -76 dBm. Two interferers at 2405 and 2408 MHz respectively, at the given power level		-42		dBm

(1) Numbers given as I/C dB

(2) X / Y, where X is +N MHz and Y is -N MHz

(3) Excluding one exception at $F_{\text{wanted}} / 2$, per Bluetooth Specification

4.7. 125-kbps Coded (Bluetooth 5) – TX

RF performance is specified in a single ended 50 ohm reference plane at the antenna feeding point with $T_c = 25^\circ\text{C}$, $V_{\text{DD5}} = 3.0\text{ V}$, $f_{\text{RF}} = 2440\text{ MHz}$, unless otherwise noted.

Parameter	Test Conditions	Min	Typ	Max	Units
Output power, highest setting	Delivered to a single-ended 50- Ω load	3.2	4.8	5.6	dBm
Output power, lowest setting	Delivered to a single-ended 50- Ω load		-21		dBm
Spurious emission conducted measurement ⁽¹⁾	$f < 1\text{ GHz}$, outside restricted bands		-43		dBm
	$f < 1\text{ GHz}$, restricted bands ETSI		-65		dBm
	$f < 1\text{ GHz}$, restricted bands FCC		-76		dBm
	$f > 1\text{ GHz}$, including harmonics		-46		dBm

(1) Suitable for systems targeting compliance with worldwide radio-frequency regulations ETSI EN 300 328 and EN

300 440 Class 2 (Europe), FCC CFR47 Part 15 (US), and ARIB STD-T66 (Japan).

4.8. 500-kbps Coded (Bluetooth 5) – RX

RF performance is specified in a single ended 50 ohm reference plane at the antenna feeding point with $T_c = 25^\circ\text{C}$, $V_{DD5} = 3.0\text{ V}$, $f_{RF} = 2440\text{ MHz}$, unless otherwise noted.

Parameter	Test Conditions	Min	Typ	Max	Units
Receiver sensitivity	BER = 10^{-3}		-101		dBm
Receiver saturation	BER = 10^{-3}		>5		dBm
Frequency error tolerance	Difference between the incoming carrier frequency and the internally generated carrier frequency	-240		240	kHz
Data rate error tolerance	Difference between incoming data rate and the internally generated data rate (37-byte packets)	-500		500	ppm
Data rate error tolerance	Difference between incoming data rate and the internally generated data rate (255-byte packets)	-310		330	ppm
Co-channel rejection ⁽¹⁾	Wanted signal at -72 dBm, modulated interferer in channel, BER = 10^{-3}		-5		dB
Selectivity, $\pm 1\text{ MHz}$ ⁽¹⁾	Wanted signal at -72 dBm, modulated interferer at $\pm 1\text{ MHz}$, BER = 10^{-3}		9 / 5 ⁽²⁾		dB
Selectivity, $\pm 2\text{ MHz}$ ⁽¹⁾	Wanted signal at -72 dBm, modulated interferer at $\pm 2\text{ MHz}$, BER = 10^{-3}		41/31 ⁽²⁾		dB
Selectivity, $\pm 3\text{ MHz}$ ⁽¹⁾	Wanted signal at -72 dBm, modulated interferer at $\pm 3\text{ MHz}$, BER = 10^{-3}		44/41 ⁽²⁾		dB
Selectivity, $\pm 4\text{ MHz}$ ⁽¹⁾	Wanted signal at -72 dBm, modulated interferer at $\pm 4\text{ MHz}$, BER = 10^{-3}		44/44 ⁽²⁾		dB
Selectivity, $\pm 6\text{ MHz}$ ⁽¹⁾	Wanted signal at -72 dBm, modulated interferer at $\pm 6\text{ MHz}$, BER = 10^{-3}		44/44 ⁽²⁾		dB
Alternate channel rejection, $\pm 7\text{ MHz}$ ⁽¹⁾	Wanted signal at -72 dBm, modulated interferer at $\geq \pm 7\text{ MHz}$, BER = 10^{-3}		44/44 ⁽²⁾		dB
Selectivity, Image frequency ⁽¹⁾	Wanted signal at -72 dBm, modulated interferer at image frequency, BER = 10^{-3}		31		dB
Selectivity, Image frequency $\pm 1\text{ MHz}$ ⁽¹⁾	Note that Image frequency +1 MHz is the Co-channel -1 MHz. Wanted signal at -72 dBm, modulated interferer at $\pm 1\text{ MHz}$ from image frequency, BER = 10^{-3}		5/41 ⁽²⁾		dB
Blocker rejection, ± 8	Wanted signal at -72 dBm, modulated interferer at		44		

MHz and above ⁽¹⁾	±8 MHz and above, BER = 10 ⁻³				
Out-of-band blocking ⁽³⁾	30 MHz to 2000 MHz		-35		dBm
Out-of-band blocking	2003 MHz to 2399 MHz		-19		dBm
Out-of-band blocking	2484 MHz to 2997 MHz		-19		dBm
Intermodulation	Wanted signal at 2402 MHz, -69 dBm. Two interferers at 2405 and 2408 MHz respectively, at the given power level		-37		dBm

(1) Numbers given as I/C dB

(2) X / Y, where X is +N MHz and Y is -N MHz

(3) Excluding one exception at Fwanted / 2, per Bluetooth Specification

4.9. 500-kbps Coded (Bluetooth 5) – TX

RF performance is specified in a single ended 50 ohm reference plane at the antenna feeding point with Tc = 25°C, VDD5 = 3.0 V, f_{RF} = 2440 MHz, unless otherwise noted.

Parameter	Test Conditions	Min	Typ	Max	Units
Output power, highest setting	Delivered to a single-ended 50-Ω load	3.2	4.8	5.6	dBm
Output power, lowest setting	Delivered to a single-ended 50-Ω load		-21		dBm
Spurious emission conducted measurement ⁽¹⁾	f < 1 GHz, outside restricted bands		-43		dBm
	f < 1 GHz, restricted bands ETSI		-65		dBm
	f < 1 GHz, restricted bands FCC		-76		dBm
	f > 1 GHz, including harmonics		-46		dBm

(1) Suitable for systems targeting compliance with worldwide radio-frequency regulations ETSI EN 300 328 and EN 300 440 Class 2 (Europe), FCC CFR47 Part 15 (US), and ARIB STD-T66 (Japan).

4.10. 1-Mbps GFSK (Bluetooth Low Energy) – RX

RF performance is specified in a single ended 50 ohm reference plane at the antenna feeding point with Tc = 25°C, VDD5 = 3.0 V, f_{RF} = 2440 MHz, unless otherwise noted.

Parameter	Test Conditions	Min	Typ	Max	Units
Receiver sensitivity	BER = 10 ⁻³		-96		dBm
Receiver saturation	BER = 10 ⁻³		4		dBm
Frequency error tolerance	Difference between the incoming carrier frequency and the internally generated carrier frequency	-350		350	kHz
Data rate error tolerance	Difference between incoming data rate and the internally generated data rate	-750		750	ppm

Co-channel rejection ⁽¹⁾	Wanted signal at -67 dBm, modulated interferer in channel, BER = 10 ⁻³		-6		dB
Selectivity, ±1 MHz ⁽¹⁾	Wanted signal at -67 dBm, modulated interferer at ±1 MHz, BER = 10 ⁻³		7 / 3 ⁽²⁾		dB
Selectivity, ±2 MHz ⁽¹⁾	Wanted signal at -67 dBm, modulated interferer at ±2 MHz, BER = 10 ⁻³		34/25 ⁽²⁾		dB
Selectivity, ±3 MHz ⁽¹⁾	Wanted signal at -67 dBm, modulated interferer at ±3 MHz, BER = 10 ⁻³		38/26 ⁽²⁾		dB
Selectivity, ±4 MHz ⁽¹⁾	Wanted signal at -67 dBm, modulated interferer at ±4 MHz, BER = 10 ⁻³		42/29 ⁽²⁾		dB
Selectivity, ±5 MHz or more ⁽¹⁾	Wanted signal at -67 dBm, modulated interferer at ≥ ±5 MHz, BER = 10 ⁻³		32		dB
Selectivity, Image frequency ⁽¹⁾	Wanted signal at -67 dBm, modulated interferer at image frequency, BER = 10 ⁻³		25		dB
Selectivity, Image frequency ±1 MHz ⁽¹⁾	Wanted signal at -67 dBm, modulated interferer at ±1 MHz from image frequency, BER = 10 ⁻³		3/26 ⁽²⁾		dB
Out-of-band blocking ⁽³⁾	30 MHz to 2000 MHz		-20		dBm
Out-of-band blocking	2003 MHz to 2399 MHz		-5		dBm
Out-of-band blocking	2484 MHz to 2997 MHz		-8		dBm
Out-of-band blocking	3000 MHz to 12.75 GHz		-8		dBm
Intermodulation	Wanted signal at 2402 MHz, -64 dBm. Two interferers at 2405 and 2408 MHz respectively, at the given power level		-34		dBm
Spurious emissions, 30 to 1000 MHz	Conducted measurement in a 50-Ω single-ended load. Suitable for systems targeting compliance with EN 300 328, EN 300 440 class 2, FCC CFR47, Part 15 and ARIB STD-T-66		-71		dBm
Spurious emissions, 1 to 12.75 GHz	Conducted measurement in a 50-Ω single-ended load. Suitable for systems targeting compliance with EN 300 328, EN 300 440 class 2, FCC CFR47, Part 15 and ARIB STD-T-66		-62		dBm
RSSI dynamic range			70		dB
RSSI accuracy			±4		dB

(1) Numbers given as I/C dB

(2) X / Y, where X is +N MHz and Y is -N MHz

(3) Excluding one exception at $F_{\text{wanted}} / 2$, per Bluetooth Specification

4.11. 1-Mbps GFSK (Bluetooth Low Energy) – TX

RF performance is specified in a single ended 50 ohm reference plane at the antenna feeding point with $T_c = 25^\circ\text{C}$, $V_{DD5} = 3.0\text{ V}$, $f_{RF} = 2440\text{ MHz}$, unless otherwise noted.

Parameter	Test Conditions	Min	Typ	Max	Units
Output power, highest setting	Delivered to a single-ended 50-Ω load	3.2	4.8	5.6	dBm
Output power, lowest setting	Delivered to a single-ended 50-Ω load		-21		dBm
Spurious emission conducted measurement ⁽¹⁾	$f < 1\text{ GHz}$, outside restricted bands		-43		dBm
	$f < 1\text{ GHz}$, restricted bands ETSI		-65		dBm
	$f < 1\text{ GHz}$, restricted bands FCC		-76		dBm
	$f > 1\text{ GHz}$, including harmonics		-46		dBm

(1) Suitable for systems targeting compliance with worldwide radio-frequency regulations ETSI EN 300 328 and EN 300 440 Class 2 (Europe), FCC CFR47 Part 15 (US), and ARIB STD-T66 (Japan).

4.12. 2-Mbps GFSK (Bluetooth 5) – RX

RF performance is specified in a single ended 50 ohm reference plane at the antenna feeding point with $T_c = 25^\circ\text{C}$, $V_{DD5} = 3.0\text{ V}$, $f_{RF} = 2440\text{ MHz}$, unless otherwise noted.

Parameter	Test Conditions	Min	Typ	Max	Units
Receiver sensitivity	$\text{BER} = 10^{-3}$		-92		dBm
Receiver saturation	$\text{BER} = 10^{-3}$		4		dBm
Frequency error tolerance	Difference between the incoming carrier frequency and the internally generated carrier frequency	-300		500	kHz
Data rate error tolerance	Difference between incoming data rate and the internally generated data rate	-1000		1000	ppm
Co-channel rejection ⁽¹⁾	Wanted signal at -67 dBm, modulated interferer in channel, $\text{BER} = 10^{-3}$		-7		dB
Selectivity, $\pm 2\text{ MHz}$ ⁽¹⁾	Wanted signal at -67 dBm, modulated interferer at $\pm 2\text{ MHz}$, $\text{BER} = 10^{-3}$		8/4 ⁽²⁾		dB
Selectivity, $\pm 4\text{ MHz}$ ⁽¹⁾	Wanted signal at -67 dBm, modulated interferer at $\pm 4\text{ MHz}$, $\text{BER} = 10^{-3}$		31/26 ⁽²⁾		dB
Selectivity, $\pm 6\text{ MHz}$ ⁽¹⁾	Wanted signal at -67 dBm, modulated interferer at $\pm 6\text{ MHz}$, $\text{BER} = 10^{-3}$		37/38 ⁽²⁾		dB
Alternate channel rejection, $\pm 7\text{ MHz}$ ⁽¹⁾	Wanted signal at -67 dBm, modulated interferer at $\geq \pm 7\text{ MHz}$, $\text{BER} = 10^{-3}$		37/36 ⁽²⁾		dB
Selectivity, Image	Wanted signal at -67 dBm, modulated interferer at		4		dB

frequency ⁽¹⁾	image frequency, BER = 10 ⁻³				
Selectivity, Image frequency ± 2 MHz ⁽¹⁾	Note that Image frequency +2 MHz is the Co-channel. Wanted signal at -67 dBm, modulated interferer at ± 2 MHz from image frequency, BER = 10 ⁻³		3/26 ⁽²⁾		dB
Out-of-band blocking ⁽³⁾	30 MHz to 2000 MHz		-33		dBm
Out-of-band blocking	2003 MHz to 2399 MHz		15		dBm
Out-of-band blocking	2484 MHz to 2997 MHz		-12		dBm
Out-of-band blocking	3000 MHz to 12.75 GHz		-10		dBm
Intermodulation	Wanted signal at 2402 MHz, -64 dBm. Two interferers at 2405 and 2408 MHz respectively, at the given power level		-34		dBm

(1) Numbers given as I/C dB

(2) X / Y, where X is +N MHz and Y is -N MHz

(3) Excluding one exception at $F_{\text{wanted}} / 2$, per Bluetooth Specification

4.13. 2-Mbps GFSK (Bluetooth 5) – TX

RF performance is specified in a single ended 50 ohm reference plane at the antenna feeding point with $T_c = 25^\circ\text{C}$, $V_{\text{DD5}} = 3.0\text{ V}$, $f_{\text{RF}} = 2440\text{ MHz}$, unless otherwise noted.

Parameter	Test Conditions	Min	Typ	Max	Units
Output power, highest setting	Delivered to a single-ended 50- Ω load	3.2	4.8	5.6	dBm
Output power, lowest setting	Delivered to a single-ended 50- Ω load		-21		dBm
Error vector magnitude	At maximum output power		2		%
Spurious emission conducted measurement ⁽¹⁾	$f < 1\text{ GHz}$, outside restricted bands		-43		dBm
	$f < 1\text{ GHz}$, restricted bands ETSI		-65		dBm
	$f < 1\text{ GHz}$, restricted bands FCC		-76		dBm
	$f > 1\text{ GHz}$, including harmonics		-46		dBm

(1) Suitable for systems targeting compliance with worldwide radio-frequency regulations ETSI EN 300 328 and EN 300 440 Class 2 (Europe), FCC CFR47 Part 15 (US), and ARIB STD-T66 (Japan).

4.14. Internal 24-MHz Crystal Oscillator (XOSC_HF)⁽¹⁾

over operating free-air temperature range (unless otherwise noted)

Parameter	Test Conditions	Min	Typ	Max	Units
Crystal frequency			24		MHz

Crystal frequency tolerance ⁽²⁾		-40		+40	ppm
Start-up time ⁽³⁾			150		μs

- (1) Probing or otherwise stopping the XTAL while the DC-DC converter is enabled may cause permanent damage to the device.
- (2) Includes initial tolerance of the crystal, drift over temperature, aging and frequency pulling due to incorrect load capacitance. As per Bluetooth specification
- (3) Kick-started based on a temperature and aging compensated RCOSC_HF using precharge injection

4.15. 32.768-kHz Crystal Oscillator (XOSC_LF)

over operating free-air temperature range (unless otherwise noted)

Parameter	Test Conditions	Min	Typ	Max	Units
Crystal frequency			32.768		KHz
Initial crystal frequency tolerance, Bluetooth low energy applications	Tc = 25°C	-20		20	ppm
Crystal aging		-3		3	ppm/year

4.16. 48-MHz RC Oscillator (RCOSC_HF)

Tc = 25°C, VDD5 = 3.0 V, unless otherwise noted.

Parameter	Test Conditions	Min	Typ	Max	Units
Frequency			48		MHz
Uncalibrated frequency accuracy			±1		%
Calibrated frequency accuracy ⁽¹⁾			±0.25		%
Start-up time			5		μs

- (1) Accuracy relatively to the calibration source (XOSC_HF).

4.17. 32-kHz RC Oscillator (RCOSC_LF)

Tc = 25°C, VDD5 = 3.0 V, unless otherwise noted.

Parameter	Test Conditions	Min	Typ	Max	Units
Calibrated frequency			32.8		KHz
Temperature coefficient			50		ppm/°C

4.18. ADC Characteristics⁽¹⁾

T_c = 25°C, V_{DD}S = 3.0 V and voltage scaling enabled, unless otherwise noted.

Parameter	Test Conditions	Min	Typ	Max	Units
Input voltage range		0		V _{DD} S	V
Resolution			12		Bits
Sample rate				200	ksps
Offset	Internal 4.3-V equivalent reference ⁽²⁾		2		LSB
Gain error	Internal 4.3-V equivalent reference ⁽²⁾		2.4		LSB
DNL ⁽³⁾ - Differential nonlinearity			>-1		LSB
INL - Integral nonlinearity			±3		LSB
ENOB - Effective number of bits	Internal 4.3-V equivalent reference ⁽²⁾ , 200 ksps, 9.6-kHz input tone		9.8		Bits
	V _{DD} S as reference, 200 ksps, 9.6-kHz input tone		10		Bits
	Internal 1.44-V reference, voltage scaling disabled, 32 samples average, 200 ksps, 300-Hz input tone		11.1		Bits
THD - Total harmonic distortion	Internal 4.3-V equivalent reference ⁽²⁾ , 200 ksps, 9.6-kHz input tone		-65		dB
	V _{DD} S as reference, 200 ksps, 9.6-kHz input tone		-69		dB
	Internal 1.44-V reference, voltage scaling disabled, 32 samples average, 200 ksps, 300-Hz input tone		-71		dB
SINAD / SNDR - Signal-to-noise and distortion ratio	Internal 4.3-V equivalent reference ⁽²⁾ , 200 ksps, 9.6-kHz input tone		60		dB
	V _{DD} S as reference, 200 ksps, 9.6-kHz input tone		63		dB
	Internal 1.44-V reference, voltage scaling disabled, 32 samples average, 200 ksps, 300-Hz input tone		69		dB
SFDR – Spurious-free dynamic range	Internal 4.3-V equivalent reference ⁽²⁾ , 200 ksps, 9.6-kHz input tone		67		dB
	V _{DD} S as reference, 200 ksps, 9.6-kHz input tone		72		dB
	Internal 1.44-V reference, voltage scaling disabled, 32 samples average, 200 ksps, 300-Hz input tone		73		dB
Conversion time	Serial conversion, time-to-output, 24-MHz clock		50		Clock cycles
Current consumption	Internal 4.3-V equivalent reference ⁽²⁾		0.66		mA

Current consumption	VDDS as reference		0.75		mA
Reference voltage	Equivalent fixed internal reference (input voltage scaling enabled). For best accuracy, the ADC conversion should be initiated through the TI-RTOS™ API to include the gain or offset compensation factors stored in FCFG1.		4.3 (2)(4)		V
Reference voltage	Fixed internal reference (input voltage scaling disabled). For best accuracy, the ADC conversion should be initiated through the TI-RTOS API to include the gain or offset compensation factors stored in FCFG1. This value is derived from the scaled value (4.3 V) as follows: $V_{ref} = 4.3 \text{ V} \times 1408 / 4095$		1.48		V
Reference voltage	VDDS as reference (Also known as RELATIVE) (input voltage scaling enabled)		VDDS		V
Reference voltage	VDDS as reference (Also known as RELATIVE) (input voltage scaling disabled)		VDDS/ 2.82 ⁽⁴⁾		V
Input Impedance	200 ksps, voltage scaling enabled. Capacitive input, Input impedance depends on sampling frequency and sampling time		>1		MΩ

(1) Using IEEE Std 1241™-2010 for terminology and test methods.

(2) Input signal scaled down internally before conversion, as if voltage range was 0 to 4.3 V.

(3) No missing codes. Positive DNL typically varies from +0.3 to +3.5, depending on device

(4) Applied voltage must be within absolute maximum ratings (Section 4.1) at all times.

4.19. Temperature Sensor

T_c = 25°C, VDDS = 3.0 V, unless otherwise noted.

Parameter	Test Conditions	Min	Typ	Max	Units
Resolution			4		°C
Range		-40		+85	°C
Accuracy			±5		°C
Supply voltage coefficient ⁽¹⁾			3.2		°C/V

(1) Automatically compensated when using supplied driver libraries.

4.20. Battery Monitor

T_c = 25°C, V_{DD5} = 3.0 V, unless otherwise noted.

Parameter	Test Conditions	Min	Typ	Max	Units
Resolution			50		mV
Range		1.8		3.8	V
Accuracy			13		mV

4.21. Continuous Time Comparator

T_c = 25°C, V_{DD5} = 3.0 V, unless otherwise noted.

Parameter	Test Conditions	Min	Typ	Max	Units
Input voltage range		0		V _{DD5}	V
External reference voltage		0		V _{DD5}	V
Internal reference voltage	DCOUP1 as reference		1.27		V
Offset			3		mV
Hysteresis			<2		mV
Decision time	Step from -10 mV to +10 mV		0.72		μs
Current consumption when enabled ⁽¹⁾			8.6		μA

(1) Additionally the bias module needs to be enabled when running in standby mode.

4.22. Low-Power Clocked Comparator

T_c = 25°C, V_{DD5} = 3.0 V, unless otherwise noted.

Parameter	Test Conditions	Min	Typ	Max	Units
Input voltage range		0		V _{DD5}	V
Clock frequency			32		kHz
Internal reference voltage, V _{DD5} / 2			1.49-1.51		V
Internal reference voltage, V _{DD5} / 3			1.01-1.03		V
Internal reference voltage, V _{DD5} / 4			0.78-0.79		V
Internal reference voltage, DCOUP1 / 1			1.25-1.28		V
Internal reference voltage, DCOUP1 / 2			0.63-0.65		V
Internal reference voltage, DCOUP1 / 3			0.42-0.44		V
Internal reference voltage, DCOUP1 / 4			0.33-0.34		V
Offset			<2		mV

Hysteresis			<5		mV
Decision time	Step from -50 mV to +50 mV		<1		clock cycle
Current consumption when enabled			362		nA

4.23. Programmable Current Source

Tc = 25°C, VDD5 = 3.0 V, unless otherwise noted.

Parameter	Test Conditions	Min	Typ	Max	Units
Current source programmable output range			0.25-20		μA
Resolution			0.25		μA
Current consumption ⁽¹⁾	Including current source at maximum programmable output		23		μA

(1) Additionally, the bias module must be enabled when running in standby mode.

4.24. DC Characteristics

Parameter	Test Conditions	Min	Typ	Max	Units
TA = 25°C, VDD5 = 1.8 V					
GPIO VOH at 8-mA load	IOCURR = 2, high drive GPIOs only	1.32	1.54		V
GPIO VOL at 8-mA load	IOCURR = 2, high drive GPIOs only		0.26	0.32	V
GPIO VOH at 4-mA load	IOCURR = 1	1.32	1.58		V
GPIO VOL at 4-mA load	IOCURR = 1		0.21	0.32	V
GPIO pullup current	Input mode, pullup enabled, Vpad=0V		71.7		μA
GPIO pulldown current	Input mode, pulldown enabled, Vpad=VDD5		21.1		μA
GPIO high/low input transition, no hysteresis	IH = 0, transition between reading 0 and reading 1		0.88		V
GPIO low-to-high input transition, with hysteresis	IH = 1, transition voltage for input read as 0→1		1.07		V
GPIO high-to-low input transition, with hysteresis	IH = 1, transition voltage for input read as 1→0		0.74		V
GPIO input hysteresis	IH = 1, difference between 0→1 and 1→0 points		0.33		V
TA = 25°C, VDD5 = 3.0 V					
GPIO VOH at 8-mA load	IOCURR = 2, high drive GPIOs only		2.68		V
GPIO VOL at 8-mA load	IOCURR = 2, high drive GPIOs only		0.33		V
GPIO VOH at 4-mA load	IOCURR = 1		2.72		V
GPIO VOL at 4-mA load	IOCURR = 1		0.28		V

TA = 25°C, VDD5 = 3.8 V					
GPIO pullup current	Input mode, pullup enabled, Vpad = 0 V		277		μA
GPIO pulldown current	Input mode, pulldown enabled, Vpad = VDD5		113		μA
GPIO high/low input transition, no hysteresis	IH = 0, transition between reading 0 and reading 1		1.67		V
GPIO low-to-high input transition, with hysteresis	IH = 1, transition voltage for input read as 0→1		1.94		V
GPIO high-to-low input transition, with hysteresis	IH = 1, transition voltage for input read as 1→0		1.54		V
GPIO input hysteresis	IH = 1, difference between 0→1 and 1→0 points		0.4		V
TA = 25°C					
VIH	Lowest GPIO input voltage reliably interpreted as a "High"			0.8	VDD5
VIL	Highest GPIO input voltage reliably interpreted as a "Low"	0.2			VDD5

4.25. Timing Requirements

		Min	Typ	Max	Units
Rising supply-voltage slew rate		0		100	mV/μs
Falling supply-voltage slew rate		0		20	mV/μs
Falling supply-voltage slew rate, with low-power flash settings ⁽¹⁾				3	mV/μs
Positive temperature gradient in standby ⁽²⁾	No limitation for negative temperature gradient, or outside standby mode			5	°C/s
CONTROL INPUT AC CHARACTERISTICS ⁽³⁾					
RESET_N low duration		1			μs
SYNCHRONOUS SERIAL INTERFACE (SSI) ⁽⁴⁾					
S1 (SLAVE) ⁽⁵⁾	T _{clk_per}	SSIClk period	12		65024 system clock
S2 ⁽⁵⁾	t _{clk_high}	SSIClk high time		0.5	T _{clk_per}
S3 ⁽⁵⁾	t _{clk_low}	SSIClk low time		0.5	T _{clk_per}

- (1) For smaller coin cell batteries, with high worst-case end-of-life equivalent source resistance, a 22-μF VDD input capacitor must be used to ensure compliance with this slew rate.
- (2) Applications using RCOSC_LF as sleep timer must also consider the drift in frequency caused by a change in temperature.
- (3) T_A = -40°C to 85°C, VDD5 = 1.8 V to 3.8 V, unless otherwise noted.
- (4) T_c = 25°C, VDD5 = 3.0 V, unless otherwise noted. Device operating as SLAVE. For SSI MASTER operation, see Section

4.26.

(5) Refer to SSI timing diagrams Figure 4-1, Figure 4-2, and Figure 4-3.

4.26. Switching Characteristics

Tc = 25°C, VDD5 = 3.0 V, unless otherwise noted.

Parameter	Test Conditions	Min	Typ	Max	Units
WAKEUP AND TIMING					
Idle → Active			14		μs
Standby → Active			151		μs
Shutdown → Active			1015		μs
SYNCHRONOUS SERIAL INTERFACE (SSI) ⁽¹⁾					
S1 (TX only) ⁽²⁾ t _{clk_per} (SSIClk period)	One-way communication to SLAVE	4		65024	system clocks
S1(TX and RX) ⁽²⁾ t _{clk_per} (SSIClk period)	Normal duplex operation	8		65024	system clocks
S2 ⁽²⁾ t _{clk_high} (SSIClk high time)			0.5		t _{clk_per}
S3 ⁽²⁾ t _{clk_low} (SSIClk low time)			0.5		t _{clk_per}

(1) Device operating as MASTER. For SSI SLAVE operation, see Section 4.25.

(2) Refer to SSI timing diagrams Figure 4-1, Figure 4-2, and Figure 4-3.

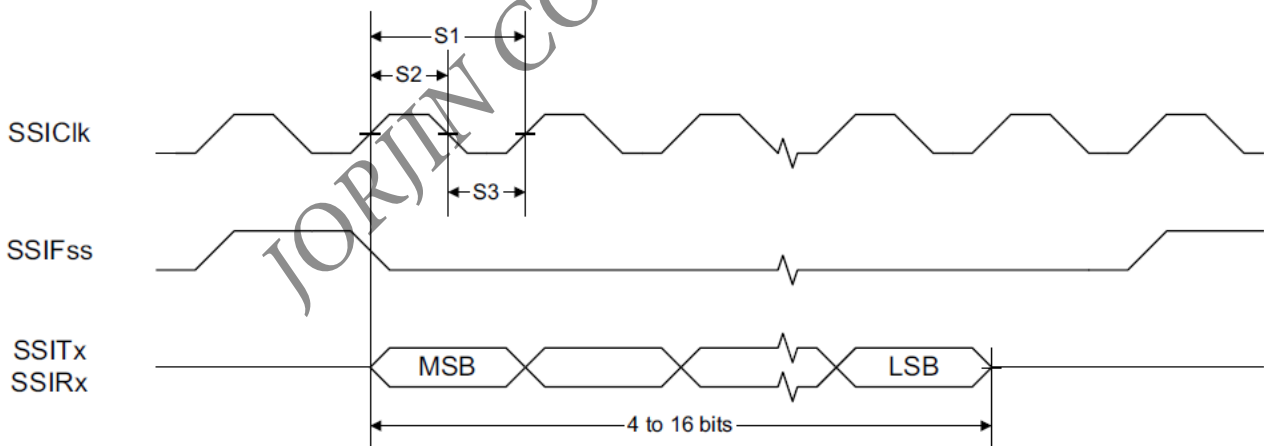

Figure 4-1. SSI Timing for TI Frame Format (FRF = 01), Single Transfer Timing Measurement

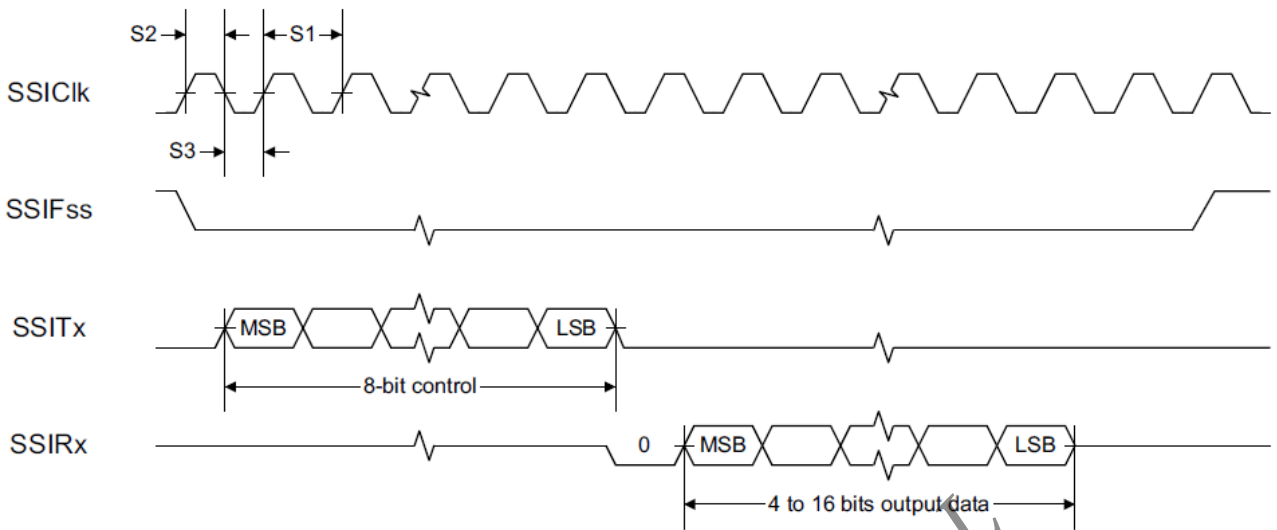

Figure 4-2. SSI Timing for MICROWIRE Frame Format (FRF = 10), Single Transfer

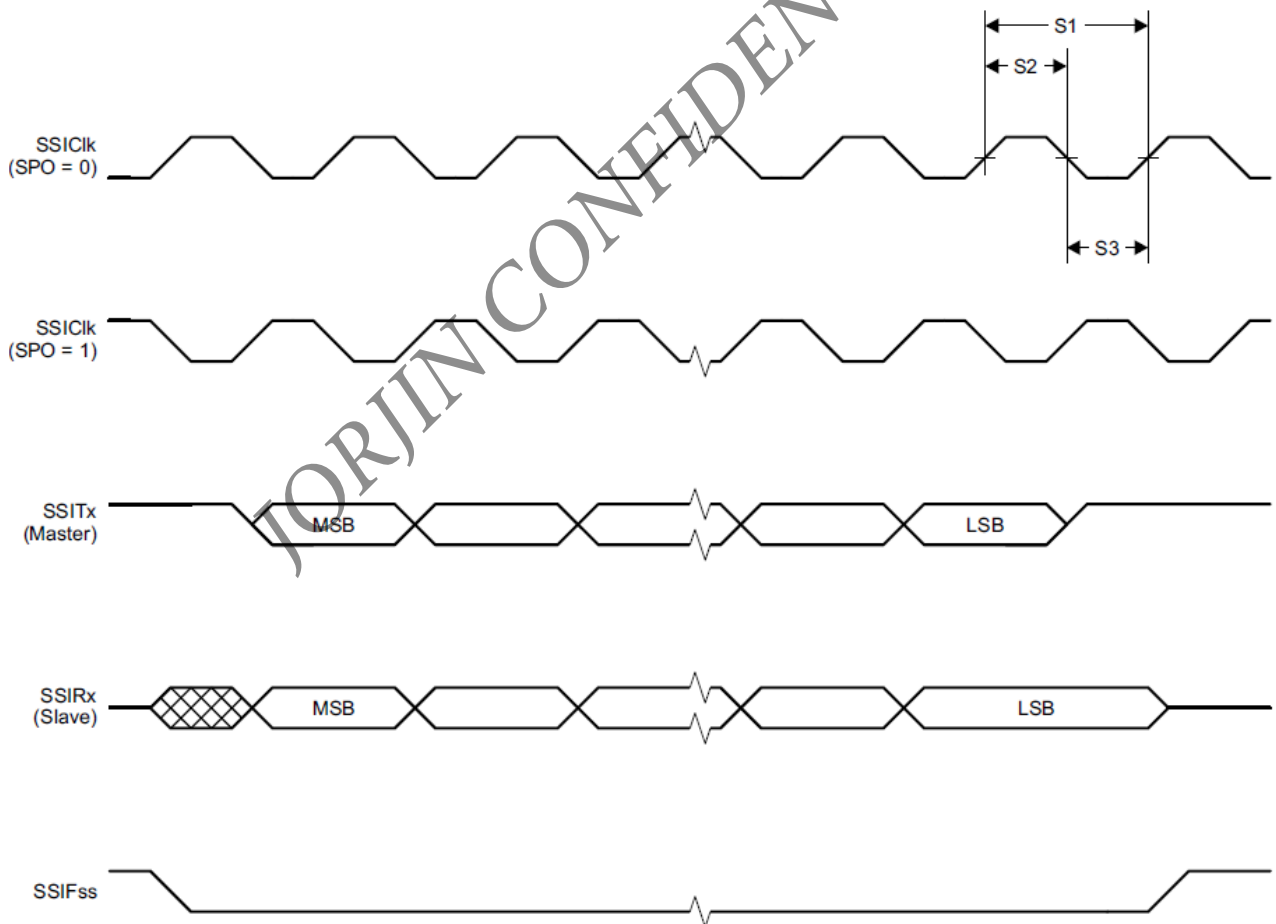

Figure 4-3. SSI Timing for SPI Frame Format (FRF = 00), With SPH = 1

4.27. Typical Characteristics

There are some typical performance plots measured on the CC2640R2FRHB device in the CC2640R2F data sheet, and the plots relevant for the ZB7412-00 module. Please visit TI web site <http://www.ti.com/lit/gpn/cc2640r2f> , and see Section 5.29

JORJIN CONFIDENTIAL

4.28. Chip Antenna Characteristics

Measured on the Jorjin ZB7412E00 EM board with TA = 25°C

Parameter	2400MHz	2442MHz	2484MHz
Efficiency%	57.6 %	59.1 %	58.9 %
Peak Gain	2.0 dBi	2.2 dBi	2.3 dBi

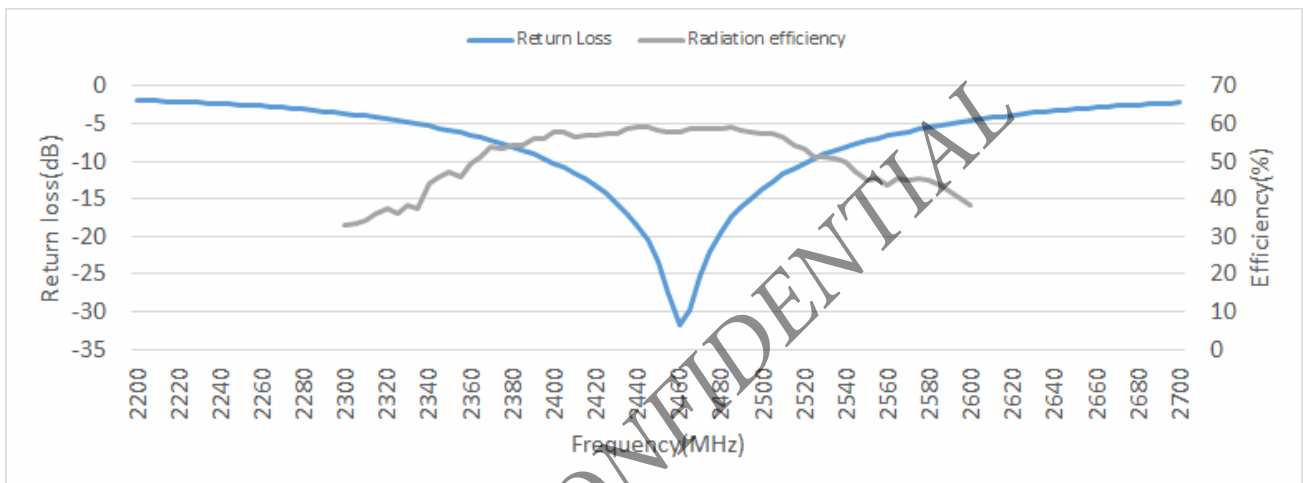
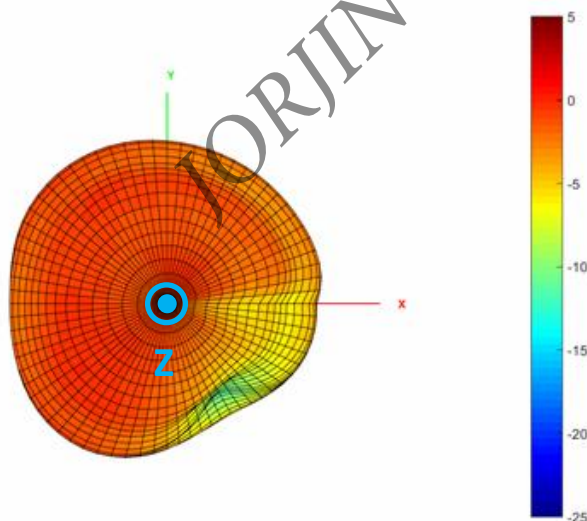

Figure 4-4. Efficiency vs. Frequency



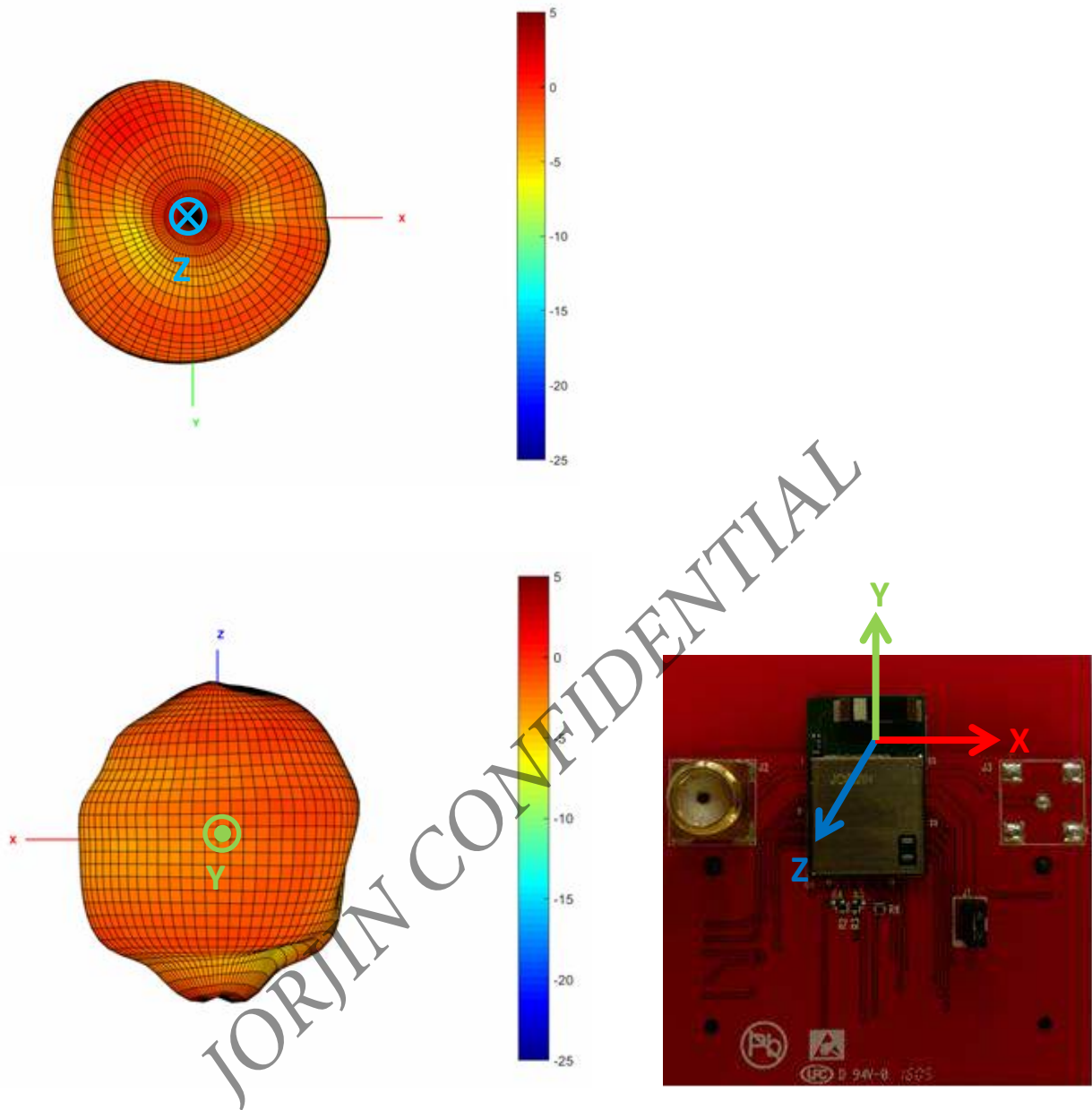

Figure 4-5. DUT 3D Pattern

5. DESIGN RECOMMENDATIONS

5.1. Module Layout Recommendations

Follow these module layout recommendations:

- Antenna

For a module with on board chip antenna, to eliminate the influence from other components or ground, recommended that the module is placed in the corner of main PCB, and define a clearance area around the antenna, where no grounding or signal trace are contained. The clearance area applies to all layers of the main PCB. The recommended dimensions of the main PCB keep out area are shown in below.

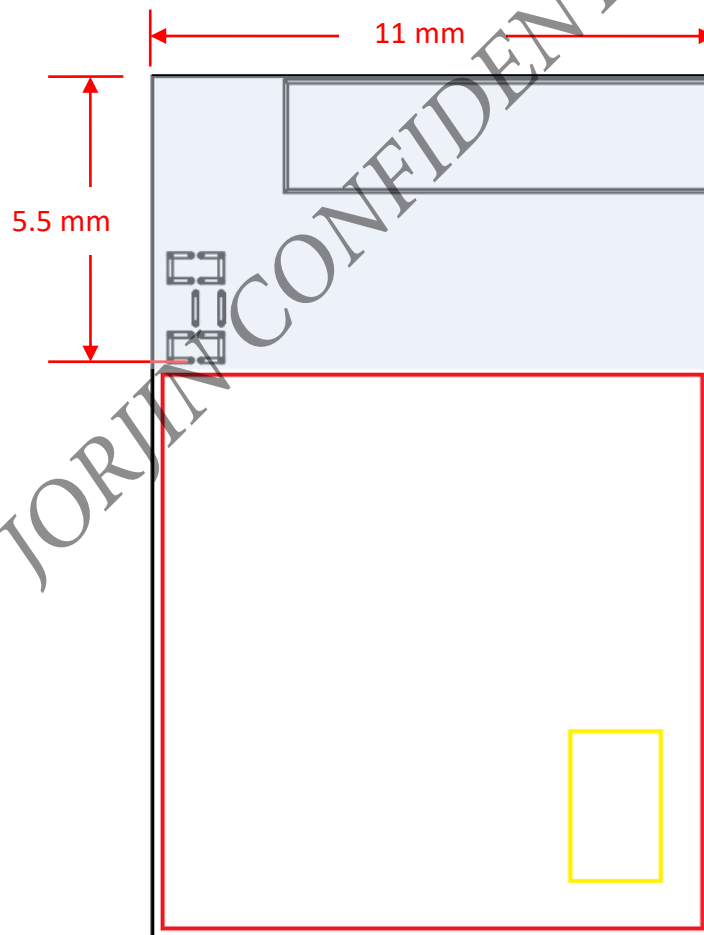

- RF test point

There are RF test points in the bottom side of this module. It is only for module production used. Do not connect any signal to these test points (leave no connection) in the module. And do not design test point in the main board. Please reserve a clearance in the top-side copper plane underneath the RF test pads. Do not route any signal or place via in this keep out area.

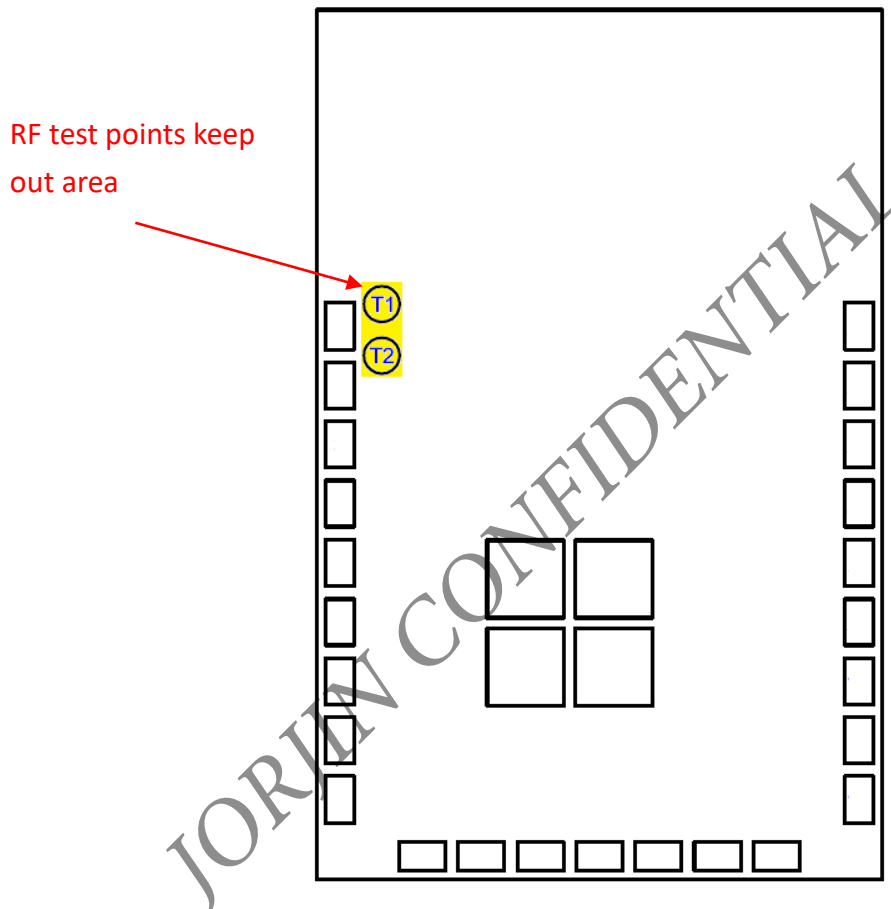

- Device and Documentation Support

For a complete device and tool documents for the CC2640R2F platform, visit the Texas Instruments website at <http://www.ti.com>.

5.2. Reference Schematic

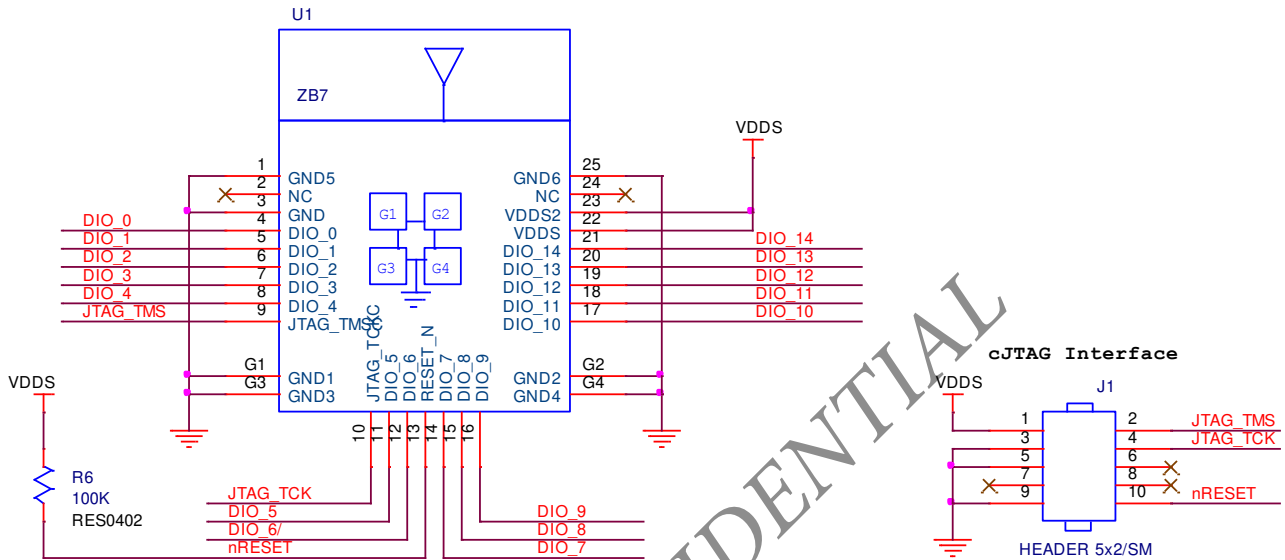

- No external decoupling is required.
- The reset line should have an external pullup resistor unless the line is actively driven. Placement of this component is not critical.
- All Digital Peripheral Pins can be routed to any GPIO.

6. PACKAGE INFORMATION

6.1. Module Mechanical Outline

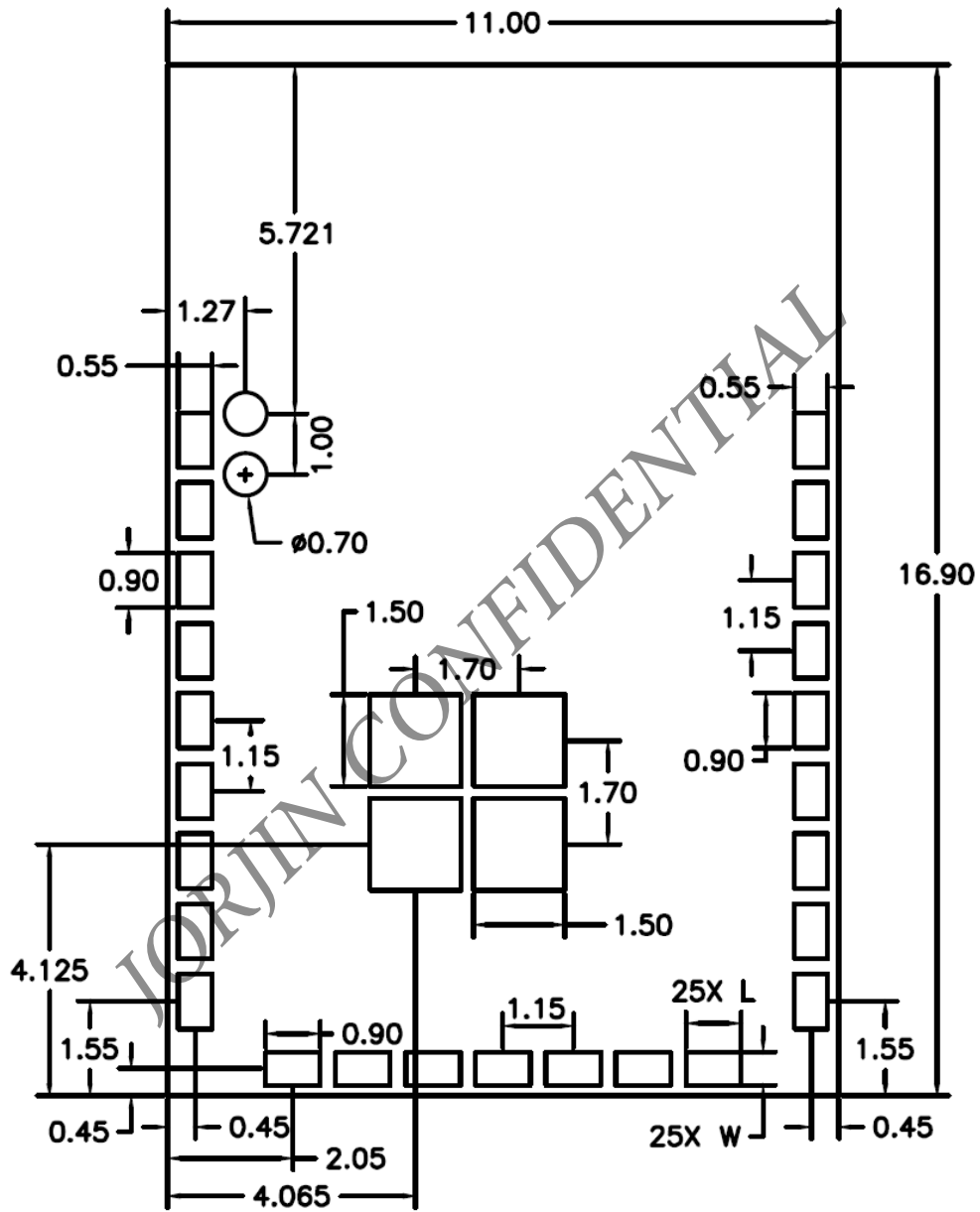

Top View

Note:

1> Pad tolerance as $\pm 30\mu\text{m}$

2> Unit: mm

Top and Side View

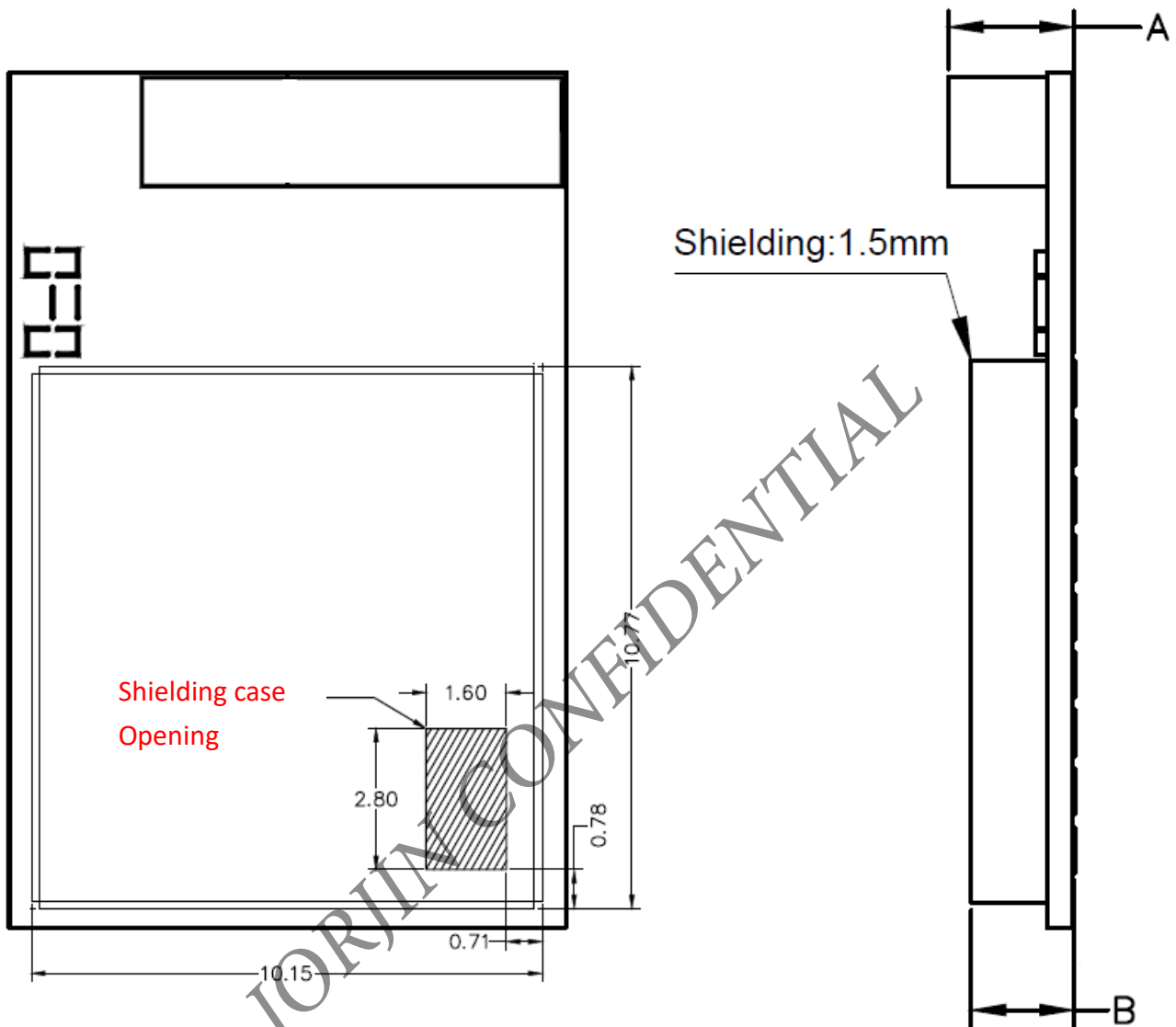

Note:

A: Typical: 2.45mm, Maximum: 2.69mm

B: Typical: 2.00mm, Maximum: 2.20mm

Unit: mm



6.2. Ordering Information

Order Number	Package
ZB7412-00	LGA-25

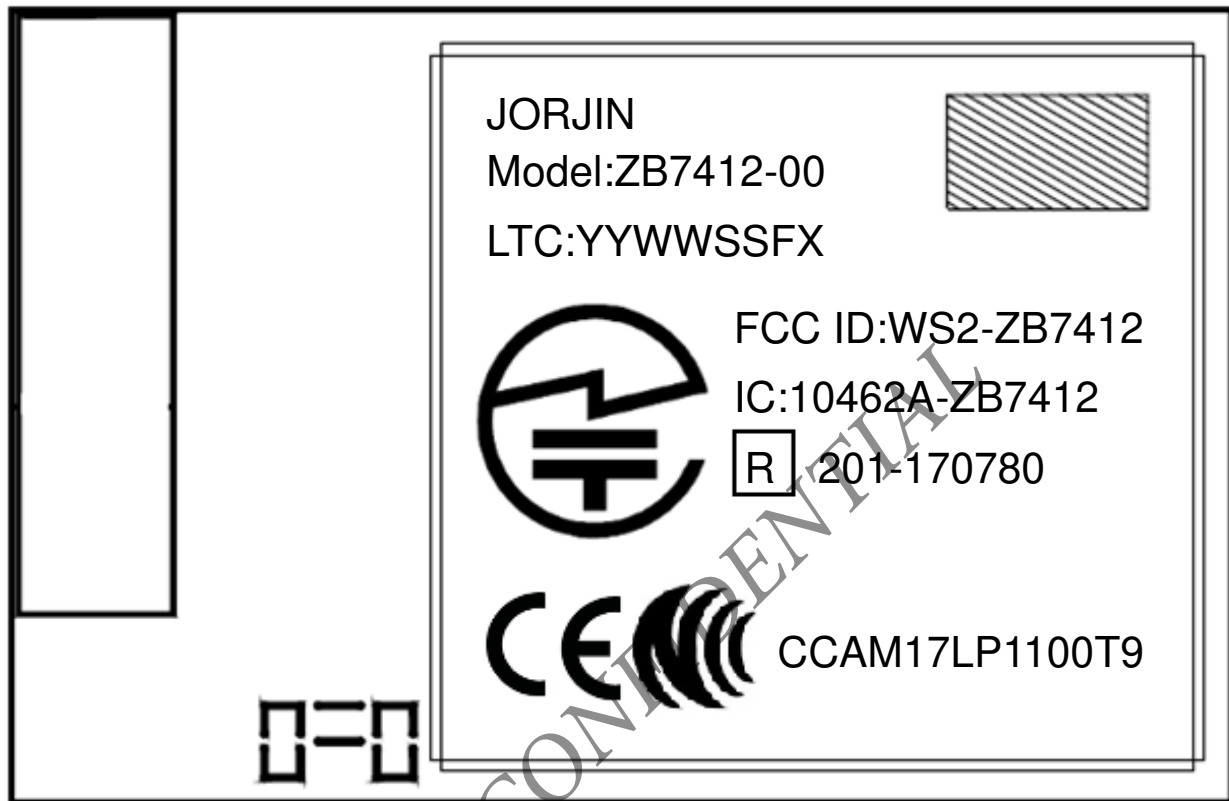
6.3. Package Marking



Marking	Description
JORJIN	Brand name
ZB7412-00	Model name
YYWWSSFX	Lot Trace Code: YYWWSSFX YY= Digit of the year, ex: 2017=17 WW= Week (01~52) SS= Serial number from 01~98 match to MFG's lot number, or 99 to repair control code F= Reverse for internal use X = A for Module version
WS2-ZB7412	FCC ID
10462A-ZB7412	Canada IC ID

	TELEC compliance mark, and ID
	CE compliance mark
	NCC compliance mark, and ID

JORJIN CONFIDENTIAL

7. SMT AND BAKING RECOMMENDATION

7.1. Baking Recommendation

- Baking condition :
 - Follow MSL Level 4 to do baking process.
 - After bag is opened, devices that will be subjected to reflow solder or other high temperature process must be
 - a) Mounted within 72 hours of factory conditions <30°C/60% RH, or
 - b) Stored at <10% RH.
 - Devices require bake, before mounting, if Humidity Indicator Card reads >10%
 - If baking is required, Devices may be baked for 8 hrs. at 125 °C.

7.2. SMT Recommendation

- Recommended Reflow profile :

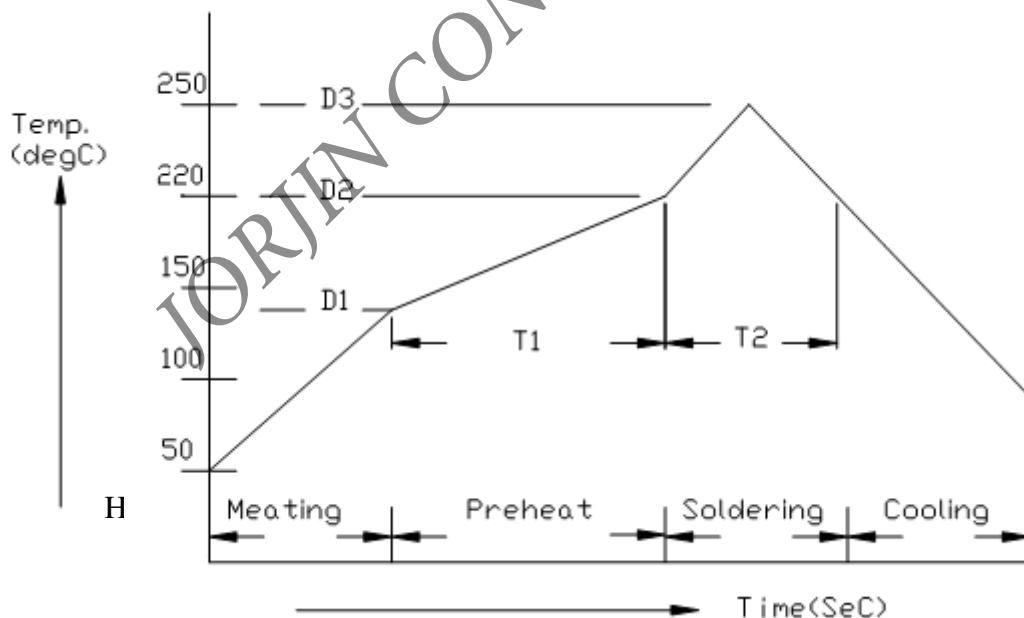

No.	Item	Temperature (°C)	Time (sec)
1	Pre-heat	D1: 140 ~ D2: 200	T1: 80 ~ 120
2	Soldering	D2: = 220	T2: 60 +/- 10
3	Peak-Temp.	D3: 250 °C max	

Note: (1) Reflow soldering is recommended two times maximum.

(2) Add Nitrogen while Reflow process : SMT solder ability will be better.

- **Stencil thickness** : 0.1~ 0.13 mm (Recommended)
- **Soldering paste (without Pb)** : Recommended SENJU N705-GRN3360-K2-V can get better soldering effects.

JORJIN CONFIDENTIAL

8. TAPE REEL INFORMATION

8.1. Cover / Carrier Tape Dimension

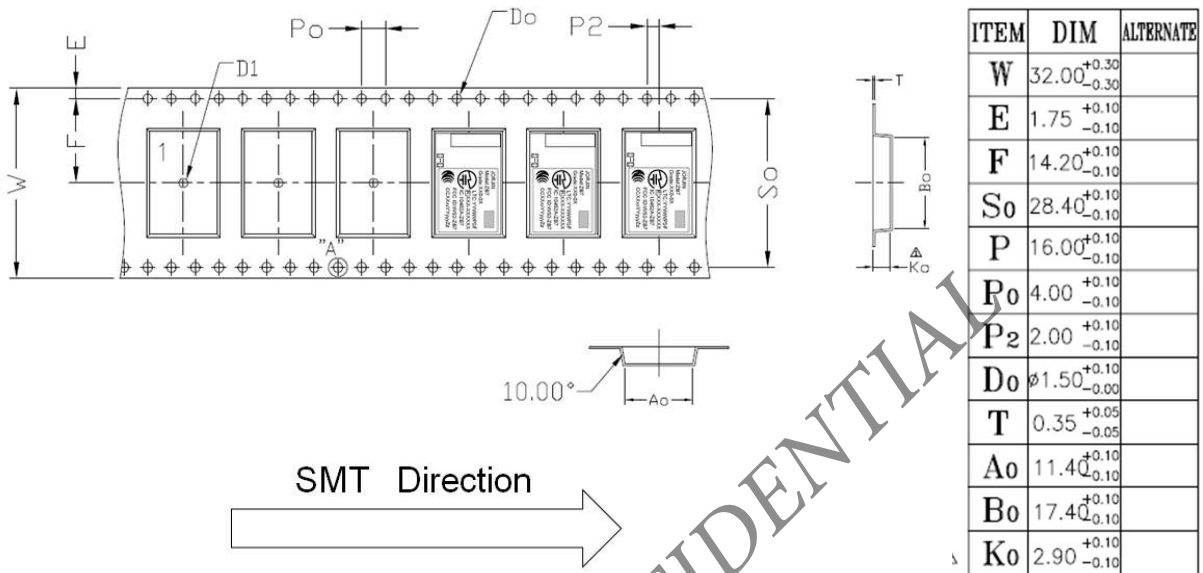

Packing Qty	Dry Bag	Inner Box	Outer Box
1200 EA / Reel	1 Reel (1200 EA)	1 Dry Bag (1200 EA)	4 Inner Box (4800 EA)

Inner Box Size : 352mm x 352mm x 56mm

Outer Box Size : 354mm x 362mm x 250mm

9. REGULATORY INFORMATION

This section outlines the regulatory information for the following countries:

- United States
- Canada
- Europe
- Japan
- Taiwan
- Australia/New Zealand
- South Korea

9.1. United States

Federal Communications Commission Statement

15.21. You are cautioned that changes or modifications not expressly approved by the part responsible for compliance could void the user's authority to operate the equipment.

This device complies with Part 15 of the FCC Rules. Operation is subject to the following two conditions:

- (1) This device may not cause harmful interference and
- (2) This device must accept any interference received, including interference that may cause undesired operation of the device.

FCC RF Radiation Exposure Statement:

This equipment complies with FCC radiation exposure limits set forth for an uncontrolled environment. End users must follow the specific operating instructions for satisfying RF exposure limits. This transmitter must not be co-located or operating in conjunction with any other antenna or transmitter.

End Product Labeling:

This module is designed to comply with the FCC statement, FCC ID: WS2-ZB7412. The host system using this module must display a visible label indicating the following text:

"Contains FCC ID: WS2-ZB7412"

Manual Information to the End User

The OEM integrator has to be aware not to provide information to the end user regarding how to

install or remove this RF module in the user's manual of the end product which integrates this module.

The end user manual shall include all required regulatory information/warning as shown in this manual.

9.2. Canada

This device complies with Industry Canada's licence-exempt RSS standard(s).

Operation is subject to the following two conditions:

- (1) this device may not cause interference, and
- (2) this device must accept any interference, including interference that may cause undesired operation of the device.

Le présent appareil est conforme aux CNR d'Industrie Canada applicables aux appareils radio exempts de licence

L'exploitation est autorisée aux deux conditions suivantes:

- (1) l'appareil ne doit pas produire de brouillage, et
- (2) l'utilisateur de l'appareil doit accepter tout brouillage radioélectrique subi, même si le brouillage est susceptible d'en compromettre le fonctionnement.

RF Radiation Exposure Statement:

This equipment complies with IC radiation exposure limits set forth for an uncontrolled environment. This equipment should be installed and operated with minimum distance 10mm between the radiator & your body. This transmitter must not be co-located or operating in conjunction with any other antenna or transmitter.

Déclaration d'exposition aux radiations:

Cet équipement est conforme aux limites d'exposition aux rayonnements IC établies pour un environnement non contrôlé. Cet équipement doit être installé et utilisé avec un minimum de 10mm de distance entre la source de rayonnement et votre corps.

End Product Labeling:

This module is designed to comply with the IC statement, IC: 10462A-ZB7. The host system using this module must display a visible label indicating the following text:

"Contains IC: 10462A-ZB7412"

Manual Information to the End User

The OEM integrator has to be aware not to provide information to the end user regarding how to install or remove this RF module in the user's manual of the end product which integrates this module.

The end user manual shall include all required regulatory information/warning as shown in this manual.

9.3. Europe

Hereby, Jorjin Technologies Inc. declares that the radio equipment type RF module is in compliance with Directive 2014/53/EU

The full text of the EU declaration of conformity is available at the following internet address:
<http://www.jorjin.com/upload/1501738499.pdf>

The compliance has been verified in the operating frequency band of 2400 MHz to 2483.5 MHz. Developers and integrators that incorporate the ZB7412-00 RF Module in any end products are responsible for obtaining applicable regulatory approvals for such end product.

The ZB7412-00 has been tested in the 2400-GHz to 2483.5-GHz ISM frequency band at 3.3 V with a maximum peak power of 7.1 dBm EIRP across the temperature range -40°C to $+85^{\circ}\text{C}$ and tolerance.

Labeling and User Information Requirements

As a result of the conformity assessment procedure described in Annex III of the Directive 2014/53/EC, the end-customer equipment should be labeled as follows:



9.4. Japan

The ZB7412-00 is certified as a module with type certification number 201-170780. End products that integrate this module do not need additional MIC Japan certification for the end product.

End product can display the certification label of the embedded module.

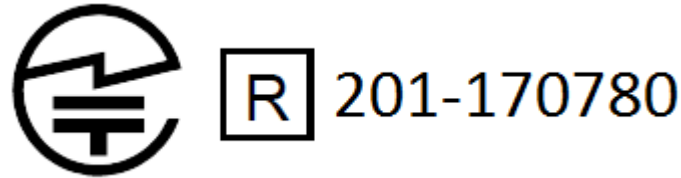

9.5. Taiwan

The ZB7412-00 is certified as a module with type certification number CCAM17LP1100T9. End products that integrate this module do not need additional NCC Taiwan certification for the end product.

End product can display the certification label of the embedded module.

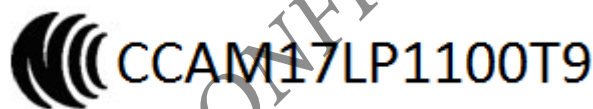

The user's manual should contain following warning (for RF device) in traditional Chinese:

注意

本產品符合低功率電波輻射性電機管理辦法：

第十二條

經形式認證合格之低功率射頻電機，非經許可，公司、商號或使用者均不得擅自變更頻率、加大功率或變更原設計之特性及功能。

第十四條

低功率射頻電機之使用不得影響飛航安全及干擾合法通信；經發現有干擾現象時，應立即停用，並改善至無干擾時方得繼續使用。

前項合法通信，指依電信規定作業之無線電信。低功率射頻電機須忍受合法通信或工業、科學及醫療用電波輻射性電機設備之干擾。

系統廠商應於平台上標示「本產品內含射頻模組:  CCAM17LP1100T9」字樣

9.6. Australia/New Zealand

This module is conformity with the following standards

- AS/NZS 4268: 2012 Amdt 1-2013

9.7. South Korea

전기용품안전관리법에 의한 표시

제품명: BLE 무선 모듈

모델명: ZB7412-00

제품정격: 1.8V ~ 3.8V

MSIP 신청업체명: R-C-JOR-ZB7412-00

제조국: 타이완

제조년월:



R-C-JOR-ZB7412-00

10. HISTORY CHANGE

Revision	Date	Description
R 0.1	2017/03/16	1. Official Released.
R 0.2	2017/03/22	1. Specification for Bluetooth 5 is to be added in near future
R 0.3	2017/08/03	<ol style="list-style-type: none"> 1. Add Bluetooth 5 2. Modify model number in this document. 3. Update marking information 4. Update regulatory information
R 0.4	2019/02/15	1. Add South Korea regulatory information

JORJIN CONFIDENTIAL