

PD06-12008

Product Specification

1. Dimensions

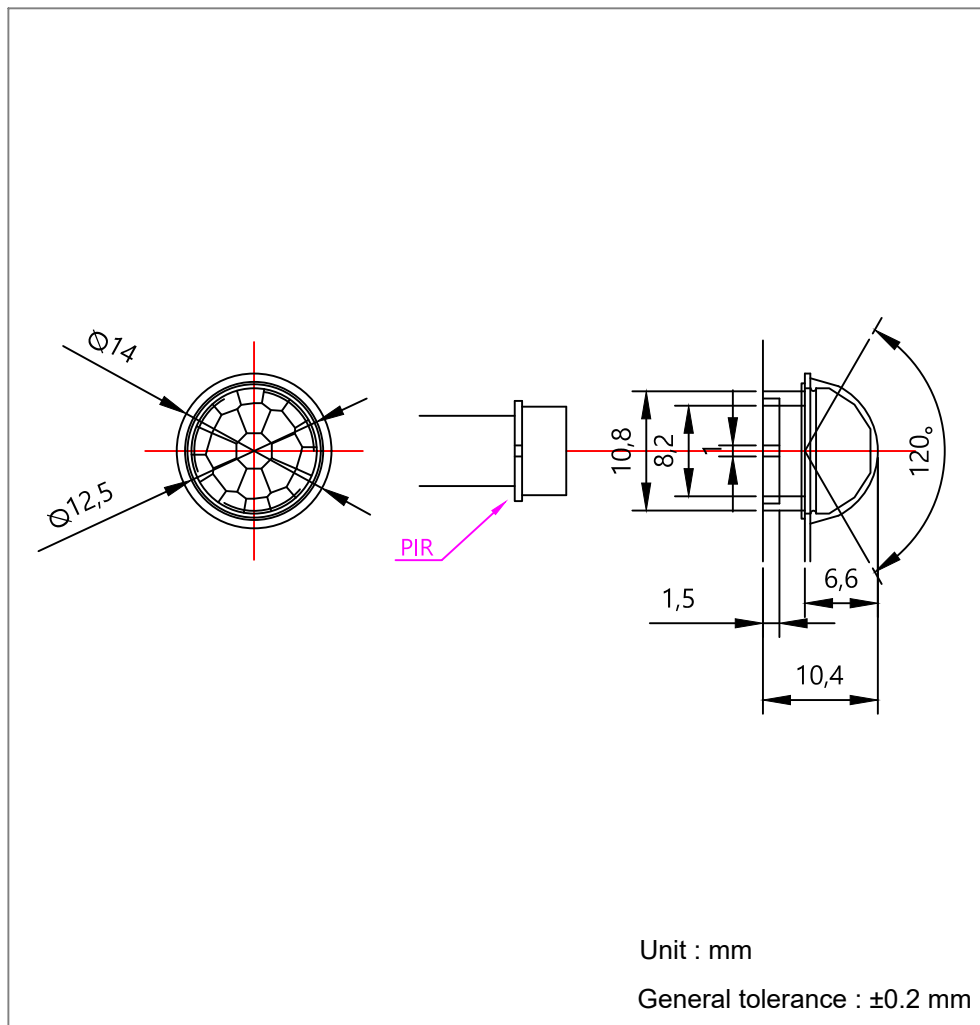

2. Field of view

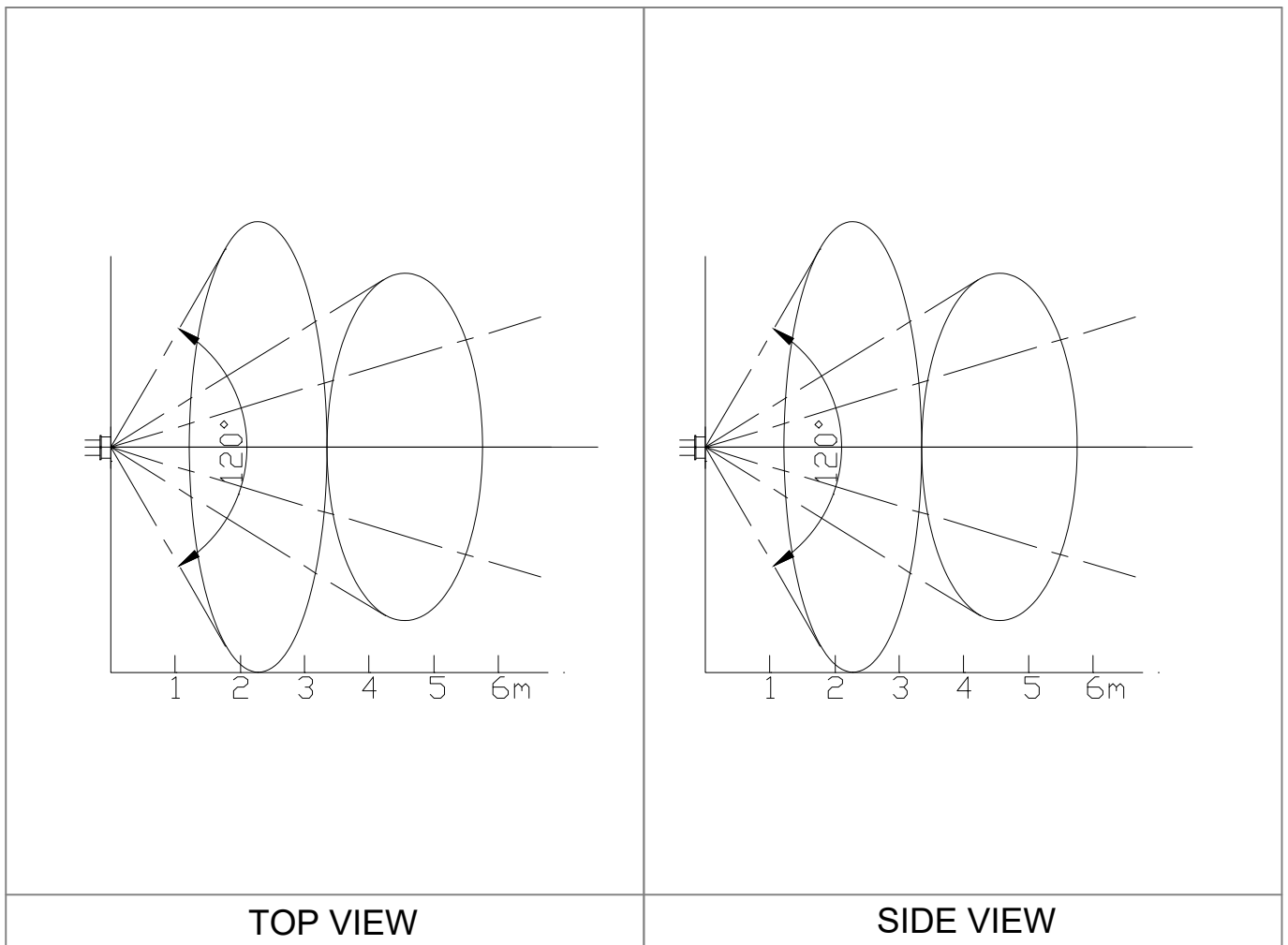

3. Material for PIR/FIR(8~13um) wavelength

The thermopile and passive infrared sensor that is using for motion sensor detects the wavelength of 8~13um.

Without Fresnel lens, the sensor only can detect less than 1m distance and narrower space with lens. To work with Pyroelectric detector and thermopile, Fresnel lens that collects infrared rays as a sensor is required. Fresnel Factory manufactures Fresnel lenses for passive infrared and absolute temperature sensors.

3-1) Poly FIR 200

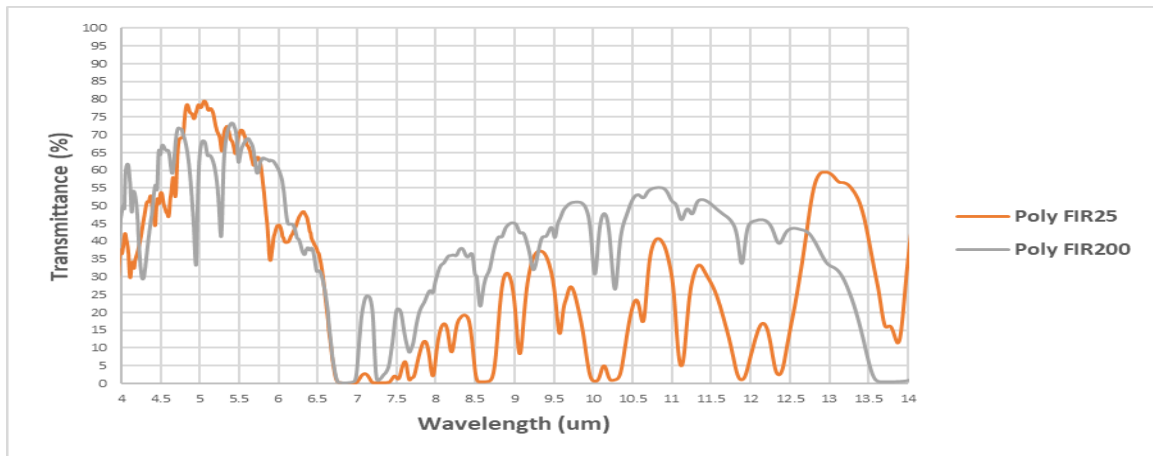

(Graph3 – Transmittance of PIR, FIR(Far infrared) material)

Material is important to have a wide FOV and excellent Far Infrared transmittance. Therefore, Fresnel Factory is using Poly FIR200 and Poly FIR25, which have a wide FOV and excellent FIR transmittance

Material name	8~12um
Poly FIR200	42.81% at 0.65T

PIR(Passive Infrared) sensor detects infrared rays in the 8~12um wavelength emitted from body temperature. Fresnel Factory's Poly FIR200 has an excellent transmittance of 42.81% on average from 8~12um wavelength when 0.65T.

Properties

Max tensile strength	Impact strength	HDT(0.45Map)	Melt Flow Rate
24.5Mpa	30.15J/m	73°C	20g/min

The price is low since the productivity is high because the melt flow rate is excellent and the time required for injection is short. Despite having the above properties, it is not suitable for use in environments exposed to high temperatures, impacts, and scratches due to its low hardness, impact strength, and HDT compared to Poly FIR25.

Reference

*HDT(Heat Deflection Temperature) : It exhibits heat resistance at a specific temperature when the sample has displacement of 2.5mm under a specific load.

*Hardness : Abrasion resistance

*Izod Impact strength : Impact resistance