

100115 Low-Skew Quad Clock Driver

General Description

The 100115 contains four low skew differential drivers, designed for generation of multiple, minimum skew differential clocks from a single differential input. This device also has the capability to select a secondary single-ended clock source for use in lower frequency system level testing.

*Replaced by 100315

Features

- Low output to output skew (≤ 75 ps)
- Differential inputs and outputs
- Small outline package
- Ideal for applications which require the low skew distribution of a clock signal to multiple outputs
- Secondary clock available for system level testing

Logic Diagram

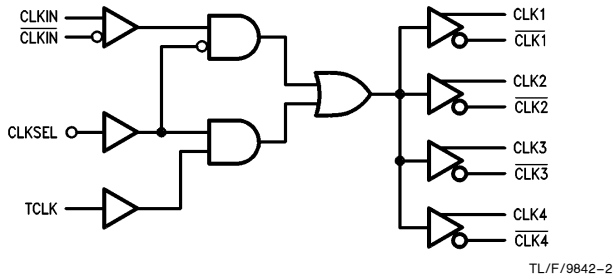

TL/F/9842-2

Connection Diagram

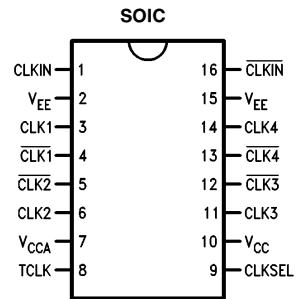

TL/F/9842-1

Pin Names	Description
CLKIN, $\overline{\text{CLKIN}}$	Differential Clock Inputs
CLK ₁₋₄ , $\overline{\text{CLK}}_{1-4}$	Differential Clock Outputs
TCLK	Test Clock Input†
CLKSEL	Clock Input Select†

†TCLK and CLKSEL are single-ended inputs, with internal 50 k Ω pulldown resistors.

Truth Table

CLKSEL	CLKIN	$\overline{\text{CLKIN}}$	TCLK	CLK _N	$\overline{\text{CLK}}_{N}$
L	L	H	X	L	H
L	H	L	X	H	L
H	X	X	L	L	H
H	X	X	H	H	L

L = Low Voltage Level
H = High Voltage Level
X = Don't Care

Absolute Maximum Ratings

Above which the useful life may be impaired (Note 1)

If Military/Aerospace specified devices are required, please contact the National Semiconductor Sales Office/Distributors for availability and specifications.

Storage Temperature –65°C to +150°C
Maximum Junction Temperature (T_J) +150°C

Case Temperature under Bias (T_C) 0°C to +85°C
V_{EE} Pin Potential to Ground Pin –7.0V to +0.5V
Input Voltage (DC) V_{CC} to +0.5V
Output Current (DC Output HIGH) –50 mA
Operating Range (Note 2) –5.7V to –4.2V

DC Electrical Characteristics

V_{EE} = –4.5V, V_{CC} = V_{CCA} = GND, T_C = 0°C to +85°C (Note 3)

Symbol	Parameter	Min	Typ	Max	Units	Conditions (Note 4)	
V _{OH}	Output HIGH Voltage	–1025	–955	–880	mV	V _{IN} = V _{IH(Max)} or V _{IL(Min)}	Loading with 50Ω to –2.0V
V _{OL}	Output LOW Voltage	–1810	–1705	–1620			
V _{OHC}	Output HIGH Voltage	–1035			mV	V _{IN} = V _{IH(Min)} or V _{IL(Max)}	Loading with 50Ω to –2.0V
V _{OLC}	Output LOW Voltage			–1610			
V _{IH}	Single-Ended Input HIGH Voltage	–1165		–880	mV	Guaranteed HIGH Signal for All Inputs	
V _{IL}	Single-Ended Input LOW Voltage	–1810		–1475	mV	Guaranteed LOW Signal for All Inputs	
I _{IL}	Input LOW Current	0.50			μA	V _{IN} = V _{IL(Min)}	

DC Electrical Characteristics

V_{EE} = –4.2V, V_{CC} = V_{CCA} = GND, T_C = 0°C to +85°C (Note 3)

Symbol	Parameter	Min	Typ	Max	Units	Conditions (Note 4)	
V _{OH}	Output HIGH Voltage	–1020		–870	mV	V _{IN} = V _{IH(Max)} or V _{IL(Min)}	Loading with 50Ω to –2.0V
V _{OL}	Output LOW Voltage	–1810		–1605			
V _{OHC}	Output HIGH Voltage	–1030			mV	V _{IN} = V _{IH(Min)} or V _{IL(Max)}	Loading with 50Ω to –2.0V
V _{OLC}	Output LOW Voltage			–1595			
V _{IH}	Single-Ended Input HIGH Voltage	–1150		–870	mV	Guaranteed HIGH Signal for All Inputs	
V _{IL}	Single-Ended Input LOW Voltage	–1810		–1475	mV	Guaranteed LOW Signal for All Inputs	
I _{IL}	Input LOW Current	0.50			μA	V _{IN} = V _{IL(Min)}	

DC Electrical Characteristics

V_{EE} = –4.8V, V_{CC} = V_{CCA} = GND, T_C = 0°C to +85°C (Note 3)

Symbol	Parameter	Min	Typ	Max	Units	Conditions (Note 4)	
V _{OH}	Output HIGH Voltage	–1035		–880	mV	V _{IN} = V _{IH(Max)} or V _{IL(Min)}	Loading with 50Ω to –2.0V
V _{OL}	Output LOW Voltage	–1830		–1620			
V _{OHC}	Output HIGH Voltage	–1045			mV	V _{IN} = V _{IH(Min)} or V _{IL(Max)}	Loading with 50Ω to –2.0V
V _{OLC}	Output LOW Voltage			–1610			
V _{IH}	Single-Ended Input HIGH Voltage	–1165		–880	mV	Guaranteed HIGH Signal for All Inputs	
V _{IL}	Single-Ended Input LOW Voltage	–1830		–1490	mV	Guaranteed LOW Signal for All Inputs	
I _{IL}	Input LOW Current	0.50			μA	V _{IN} = V _{IL(Min)}	

Note 1: Absolute maximum ratings are those values beyond which the device may be damaged or have its useful life impaired. Functional operation under these conditions is not implied.

Note 2: Parametric values specified at –4.2V to –4.8V.

Note 3: The specified limits represent the “worst case” value for the parameter. Since these “worst case” values normally occur at the temperature extremes, additional noise immunity and guard banding can be achieved by decreasing the allowable system operating ranges.

Note 4: Conditions for testing shown in the tables are chosen to guarantee operation under “worst case” conditions.

DC Electrical Characteristics

$V_{EE} = -4.2V$ to $-4.8V$ unless otherwise specified, $V_{CC} = V_{CCA} = GND$, $T_C = 0^\circ C$ to $+85^\circ C$

Symbol	Parameter	Min	Typ	Max	Units	Conditions
V_{DIFF}	Input Voltage Differential	150			mV	Required for Full Output Swing
V_{CM}	Common Mode Voltage	$V_{CC} - 2V$		$V_{CC} - 0.5V$	V	
I_{IH}	Input High Current CLKIN, \overline{CLKIN} TCLK CLKSEL			107 300 260	μA μA μA	$V_{IN} = V_{IH(Max)}$
I_{CBO}	Input Leakage Current	-10			μA	$V_{IN} = V_{EE}$
I_{EE}	Power Supply Current	-70		-30	mA	

AC Electrical Characteristics

$V_{EE} = -4.2V$ to $-4.8V$, $V_{CC} = V_{CCA} = GND$

Symbol	Parameter	$T_C = 0^\circ C$		$T_C = +25^\circ C$		$T_C = +85^\circ C$		Units	Conditions
		Min	Max	Min	Max	Min	Max		
t_{PLH} t_{PHL}	Propagation Delay CLKIN, \overline{CLKIN} to CLK ₍₁₋₄₎ , $\overline{CLK}_{(1-4)}$	0.63	0.83	0.65	0.85	0.70	0.93	ns	Figures 1, 3
t_{PLH} t_{PHL}	Propagation Delay, TCLK to CLK ₍₁₋₄₎ , $\overline{CLK}_{(1-4)}$	0.50	1.20	0.50	1.20	0.50	1.20	ns	Figures 1, 2
t_{PLH} t_{PHL}	Propagation Delay, CLKSEL to CLK ₍₁₋₄₎ , $\overline{CLK}_{(1-4)}$	0.60	1.40	0.60	1.40	0.60	1.40	ns	Figures 1, 2
$t_{S\ G-G}$	Skew Gate to Gate (Note 1)		75		75		75	ps	
t_{TLH} t_{THL}	Transition Time 20% to 80%, 80% to 20%	0.35	0.80	0.30	0.75	0.25	0.75	ns	Figures 1, 4

Note 1: Maximum output skew for any one device.

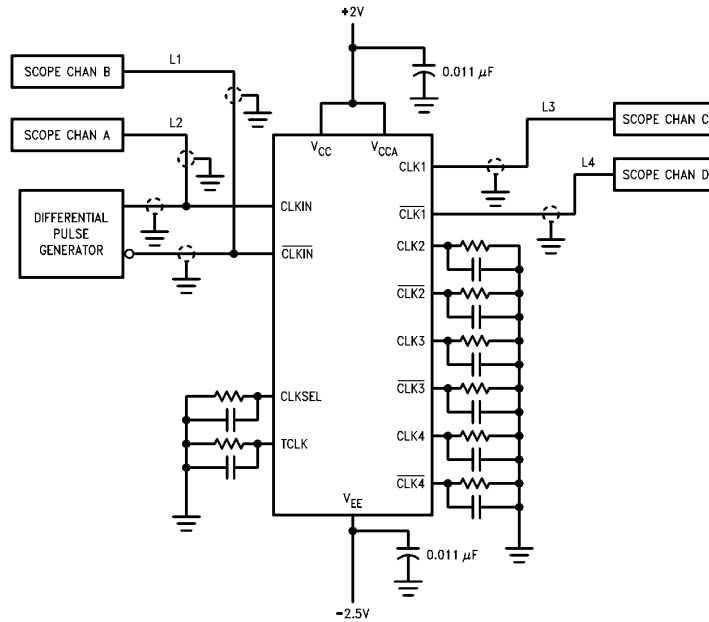

TL/F/9842-3

Note 1: Shown for testing CLKIN to CLK1 in the differential mode.

Note 2: L1, L2, L3 and L4 = equal length 50Ω impedance lines.

Note 3: All unused inputs and outputs are loaded with 50Ω in parallel with ≤ 3 pF to GND.

Note 4: Scope should have 50Ω input terminator internally.

FIGURE 1. AC Test Circuit

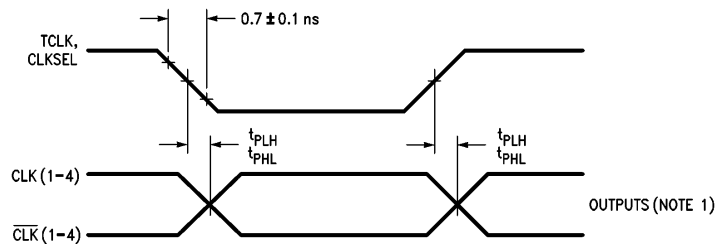

TL/F/9842-4

FIGURE 2. Propagation Delay, TCLK, CLKSEL to Outputs

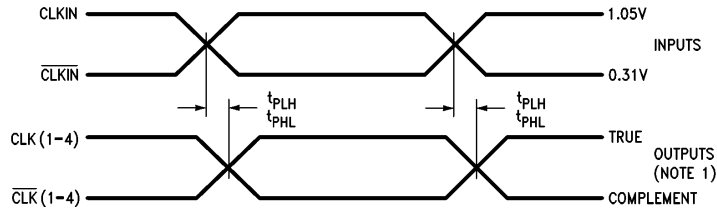

TL/F/9842-5

FIGURE 3. Propagation Delay, CLKIN/CLKIN to Outputs

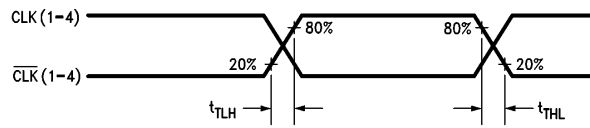

TL/F/9842-6

FIGURE 4. Transition Times

Note 1: The output to output skew, which is defined as the difference in the propagation delays between each of the four outputs on any one 100115 shall not exceed 75 ps.

Ordering Information

The device number is used to form part of a simplified purchasing code where the package type and temperature range are defined as follows:

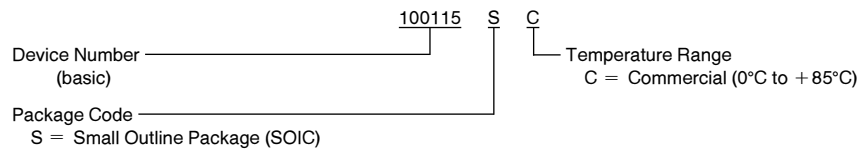

Physical Dimensions inches (millimeters)

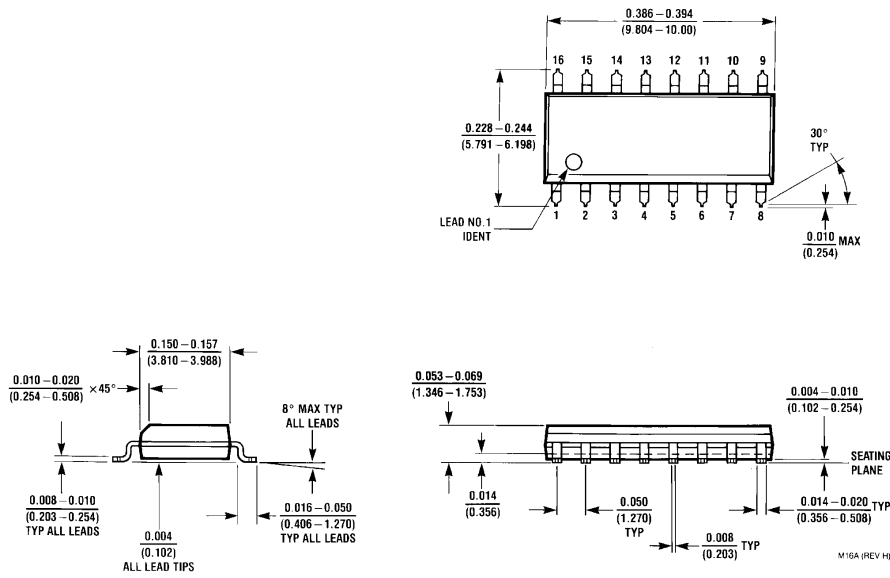

**16 Lead Small Outline Integrated Circuit (S)
NS Package Number M16A**

LIFE SUPPORT POLICY

NATIONAL'S PRODUCTS ARE NOT AUTHORIZED FOR USE AS CRITICAL COMPONENTS IN LIFE SUPPORT DEVICES OR SYSTEMS WITHOUT THE EXPRESS WRITTEN APPROVAL OF THE PRESIDENT OF NATIONAL SEMICONDUCTOR CORPORATION. As used herein:

1. Life support devices or systems are devices or systems which, (a) are intended for surgical implant into the body, or (b) support or sustain life, and whose failure to perform, when properly used in accordance with instructions for use provided in the labeling, can be reasonably expected to result in a significant injury to the user.
2. A critical component is any component of a life support device or system whose failure to perform can be reasonably expected to cause the failure of the life support device or system, or to affect its safety or effectiveness.



National Semiconductor Corporation
1111 West Bardin Road
Arlington, TX 76017
Tel: 1(800) 272-9959
Fax: 1(800) 737-7018

National Semiconductor Europe
Fax: (+49) 0-180-530 85 86
Email: cnjwge@tevm2.nsc.com
Deutsch Tel: (+49) 0-180-530 85 85
English Tel: (+49) 0-180-532 78 32
Français Tel: (+49) 0-180-532 93 58
Italiano Tel: (+49) 0-180-534 16 80

National Semiconductor Hong Kong Ltd.
19th Floor, Straight Block,
Ocean Centre, 5 Canton Rd.
Tsimshatsui, Kowloon
Hong Kong
Tel: (852) 2737-1600
Fax: (852) 2736-9960

National Semiconductor Japan Ltd.
Tel: 81-043-299-2309
Fax: 81-043-299-2408

National does not assume any responsibility for use of any circuitry described, no circuit patent licenses are implied and National reserves the right at any time without notice to change said circuitry and specifications.

This datasheet has been download from:

www.datasheetcatalog.com

Datasheets for electronics components.