



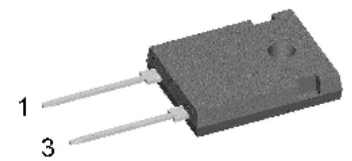
Schottky Diode

V_{RRM}	=	45 V
I_{FAV}	=	60 A
V_F	=	0.57 V

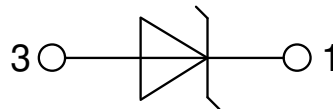
High Performance Schottky Diode
 Low Loss and Soft Recovery
 Single Diode

Part number

DSS60-0045B



Backside: cathode



Features / Advantages:

- Very low V_f
- Extremely low switching losses
- Low I_{rm} values
- Improved thermal behaviour
- High reliability circuit operation
- Low voltage peaks for reduced protection circuits
- Low noise switching

Applications:

- Rectifiers in switch mode power supplies (SMPS)
- Free wheeling diode in low voltage converters

Package: TO-247

- Industry standard outline
- RoHS compliant
- Epoxy meets UL 94V-0

Disclaimer Notice

Information furnished is believed to be accurate and reliable. However, users should independently evaluate the suitability of and test each product selected for their own applications. Littelfuse products are not designed for, and may not be used in, all applications. Read complete Disclaimer Notice at www.littelfuse.com/disclaimer-electronics.

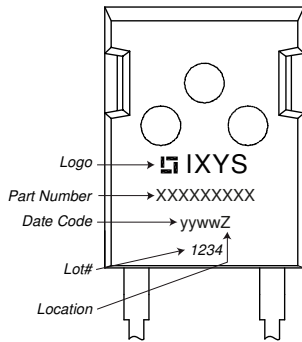


Schottky				Ratings			
Symbol	Definition	Conditions		min.	typ.	max.	Unit
V_{RSM}	max. non-repetitive reverse blocking voltage					45	V
V_{RRM}	max. repetitive reverse blocking voltage					45	V
I_R	reverse current, drain current	$V_R = 45\text{ V}$	$T_{VJ} = 25^\circ\text{C}$			60	mA
		$V_R = 45\text{ V}$	$T_{VJ} = 100^\circ\text{C}$			250	mA
V_F	forward voltage drop	$I_F = 60\text{ A}$	$T_{VJ} = 25^\circ\text{C}$			0.60	V
		$I_F = 120\text{ A}$				0.86	V
		$I_F = 60\text{ A}$	$T_{VJ} = 125^\circ\text{C}$			0.57	V
		$I_F = 120\text{ A}$				0.87	V
I_{FAV}	average forward current	$T_C = 105^\circ\text{C}$ rectangular $d = 0.5$	$T_{VJ} = 150^\circ\text{C}$			60	A
V_{FO}	threshold voltage	} for power loss calculation only				0.27	V
r_F	slope resistance					4.9	mΩ
R_{thJC}	thermal resistance junction to case					0.8	K/W
R_{thCH}	thermal resistance case to heatsink				0.25		K/W
P_{tot}	total power dissipation			$T_C = 25^\circ\text{C}$		155	W
I_{FSM}	max. forward surge current	$t = 10\text{ ms}; (50\text{ Hz}), \text{ sine}; V_R = 0\text{ V}$	$T_{VJ} = 45^\circ\text{C}$			600	A
C_J	junction capacitance	$V_R = 5\text{ V}$ $f = 1\text{ MHz}$	$T_{VJ} = 25^\circ\text{C}$		2.93		nF
E_{AS}	non-repetitive avalanche energy	$I_{AS} = 31\text{ A}$ $L = 180\text{ }\mu\text{H}$	$T_{VJ} = 25^\circ\text{C}$			137	mJ
I_{AR}	repetitive avalanche current	$V_A = 1.5 \cdot V_R$ typ. $f = 10\text{ kHz}$				3.1	A



Package TO-247			Ratings			
Symbol	Definition	Conditions	min.	typ.	max.	Unit
I_{RMS}	RMS current	per terminal			70	A
T_{VJ}	virtual junction temperature		-55		150	°C
T_{op}	operation temperature		-55		125	°C
T_{stg}	storage temperature		-55		150	°C
Weight				6		g
M_D	mounting torque		0.8		1.2	Nm
F_C	mounting force with clip		20		120	N

Product Marking

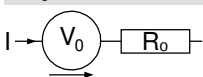


Ordering	Ordering Number	Marking on Product	Delivery Mode	Quantity	Code No.
Standard	DSS60-0045B	DSS60-0045B	Tube	30	475599

Equivalent Circuits for Simulation

** on die level*

$T_{VJ} = 150^{\circ}C$

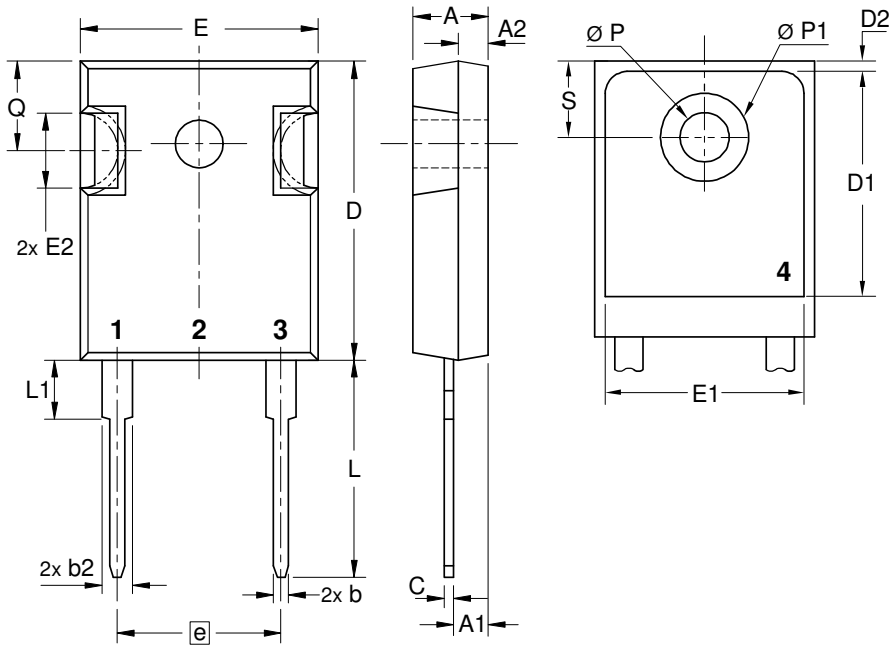


Schottky

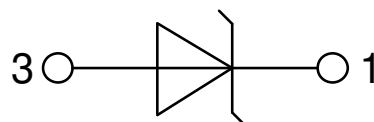
$V_{0\ max}$	threshold voltage	0.27	V
$R_{0\ max}$	slope resistance *	2.4	mΩ



Outlines TO-247



Sym.	Inches		Millimeter	
	min.	max.	min.	max.
A	0.185	0.209	4.70	5.30
A1	0.087	0.102	2.21	2.59
A2	0.059	0.098	1.50	2.49
D	0.819	0.845	20.79	21.45
E	0.610	0.640	15.48	16.24
E2	0.170	0.216	4.31	5.48
e	0.430 BSC		10.92 BSC	
L	0.780	0.800	19.80	20.30
L1	-	0.177	-	4.49
Ø P	0.140	0.144	3.55	3.65
Q	0.212	0.244	5.38	6.19
S	0.242 BSC		6.14 BSC	
b	0.039	0.055	0.99	1.40
b2	0.065	0.094	1.65	2.39
b4	0.102	0.135	2.59	3.43
c	0.015	0.035	0.38	0.89
D1	0.515	-	13.07	-
D2	0.020	0.053	0.51	1.35
E1	0.530	-	13.45	-
Ø P1	-	0.29	-	7.39



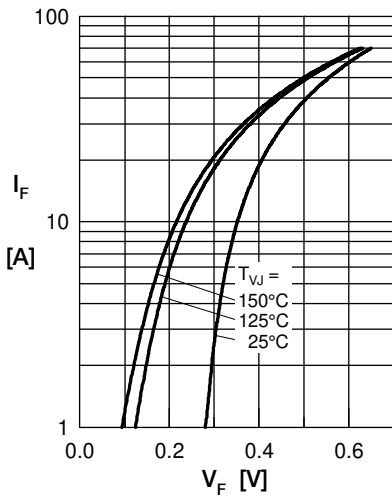
Schottky


Fig. 1 Max. forward voltage drop characteristics

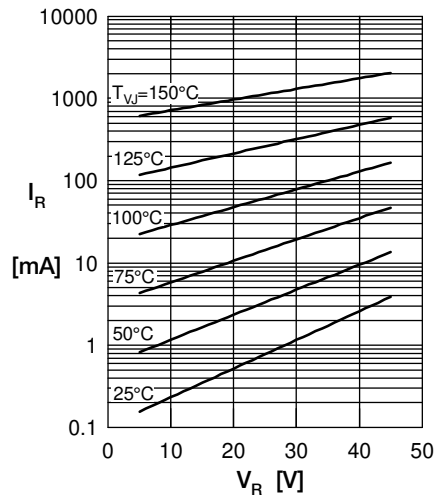
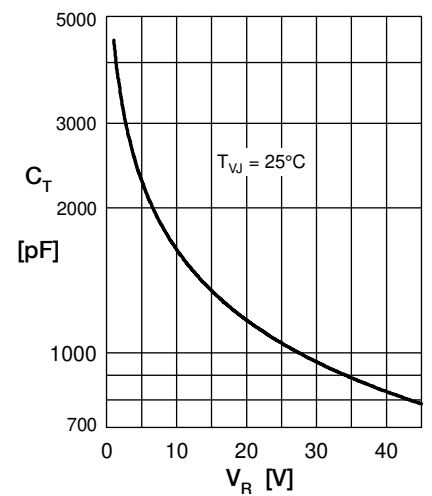
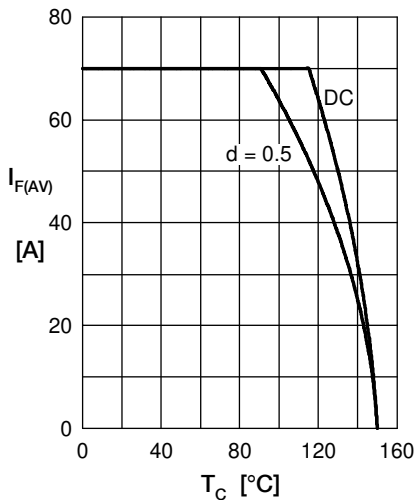
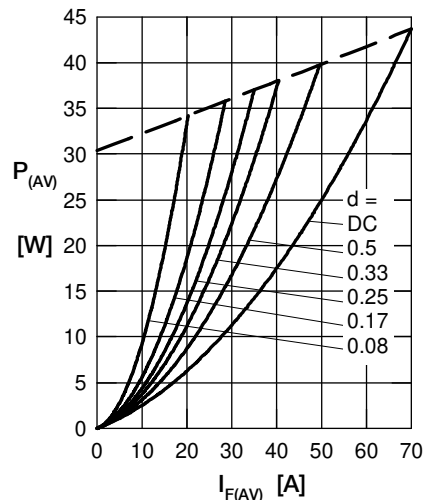

 Fig. 2 Typ. reverse current I_R vs. reverse voltage V_R

 Fig. 3 Typ. junction capacitance C_T vs. reverse voltage V_R

 Fig. 4 Average forward current $I_{F(AV)}$ vs. case temp. T_C


Fig. 5 Forward power loss characteristics

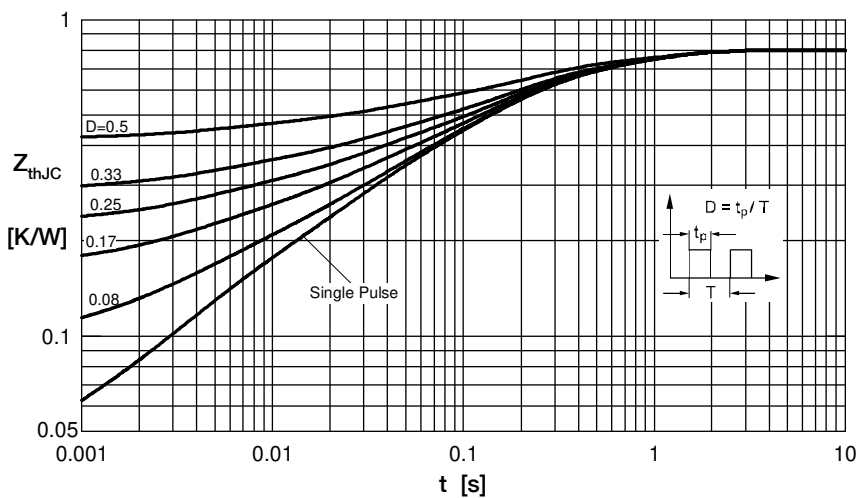


Fig. 6 Transient thermal impedance junction to case at various duty cycles

Note: All curves are per diode