

# XS1M18MB250K

Inductive proximity sensors XS, inductive sensor XS1 M18, L72mm, brass, Sn5mm, 24...240VAC/DC, 1/2"



## Main

Range of Product	Telemecanique Inductive proximity sensors XS
Series name	General purpose
Sensor Type	Inductive proximity sensor
Wiring configuration	2-wire
Output circuit type	AC/DC
Protection type	Short-circuit protection multi voltage
Device Application	2-wire DC short-circuit protection
Sensor name	XS1
Sensor design	Cylindrical M18
Size	72 mm
Body type	Fixed
Detector flush mounting acceptance	Flush mountable
Material	Metal
Type of output signal	Discrete
Wiring Technique	2-wire
[Sn] nominal sensing distance	0.20 in (5 mm)
Discrete output function	1 NC
Electrical connection	Male connector 1/2"20 UNF, 3 pins
[Us] rated supply voltage	24...210 V DC 24...240 V AC 50/60 Hz
Switching capacity in mA	5...300 mA AC overload and short-circuit protection 5...200 mA DC overload and short-circuit protection
IP degree of protection	IP67 conforming to IEC 60529

## Complementary

Thread type	M18 x 1
Detection face	Frontal
Front material	PPS
Enclosure Material	Nickel Plated Brass
Operating zone	0.00...0.16 in (0...4 mm)
Differential travel	1...15% of Sr
Status LED	Output state 1 LED yellow) Supply on 1 LED green)
Maximum residual current	1.5 mA open state
Switching frequency	<= 2000 Hz DC <= 25 Hz AC
Maximum voltage drop	<5.5 V closed state)
Maximum delay first up	70 ms
Maximum delay response	2 ms
Maximum delay recovery	4 ms
Marking	CE
Threaded length	2.01 in (51 mm)
Length	2.83 in (72 mm)

## Environment

Product Certifications	CSA CCC UL
Ambient Air Temperature for Operation	-13...158 °F (-25...70 °C)
Ambient Air Temperature for Storage	-40...185 °F (-40...85 °C)
Vibration resistance	25 gn +/- 2 mm 10...55 Hz)IEC 60068-2-6
Shock resistance	50 gn 11 ms IEC 60068-2-7

## Ordering and shipping details

Category	22486-SENSORS, PROXIMITY
Discount Schedule	DS2
GTIN	3389110915785
Nbr. of units in pkg.	1
Package weight(Lbs)	2.61 oz (74.0 g)
Returnability	No
Country of origin	FR

## Packing Units

Unit Type of Package 1	PCE
Package 1 Height	1.61 in (4.1 cm)
Package 1 width	2.56 in (6.5 cm)
Package 1 Length	3.70 in (9.4 cm)
Unit Type of Package 2	S01
Number of Units in Package 2	11
Package 2 Weight	2.24 lb(US) (1.018 kg)
Package 2 Height	5.91 in (15 cm)
Package 2 width	5.91 in (15 cm)
Package 2 Length	15.75 in (40 cm)
Package 3 Height	5.91 in (15 cm)

## Offer Sustainability

Sustainable offer status	Green Premium product
California proposition 65	WARNING: This product can expose you to chemicals including: Diisononyl phthalate (DINP), which is known to the State of California to cause cancer, and Di-isodecyl phthalate (DIDP), which is known to the State of California to cause birth defects or other reproductive harm. For more information go to <a href="http://www.P65Warnings.ca.gov">www.P65Warnings.ca.gov</a>
REACH Regulation	<a href="#">REACH Declaration</a>
EU RoHS Directive	Pro-active compliance (Product out of EU RoHS legal scope) <a href="#">EU RoHS Declaration</a>
Mercury free	Yes
RoHS exemption information	<a href="#">Yes</a>
Environmental Disclosure	<a href="#">Product Environmental Profile</a>
Circularity Profile	<a href="#">End Of Life Information</a>

## Contractual warranty

Warranty	18 months
----------	-----------

Dimensions

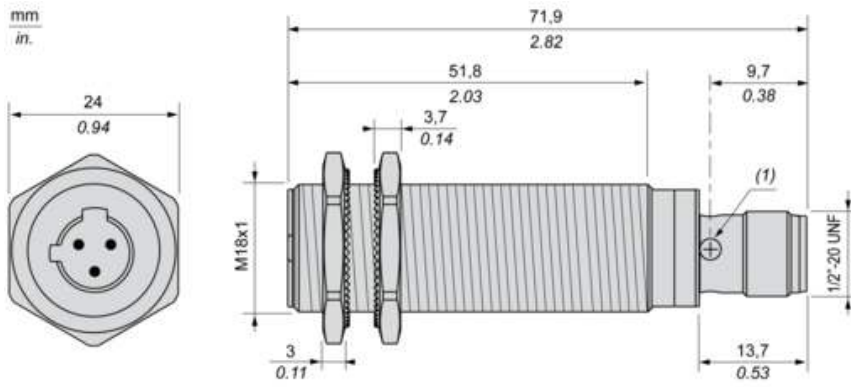

(1) : LED

---

Minimum Mounting Distances

---

Side by side

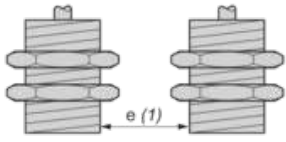

$e (1) \geq 10 \text{ mm}/0.39 \text{ in.}$

Face to face

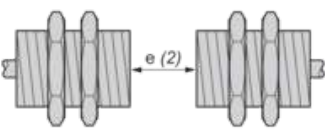

$e (2) \geq 60 \text{ mm}/2.36 \text{ in.}$

Facing a metal object

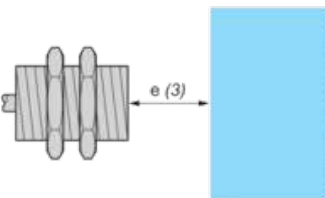

$e (3) \geq 15 \text{ mm}/0.60 \text{ in.}$

Wiring Schemes

1/2"-20UNF

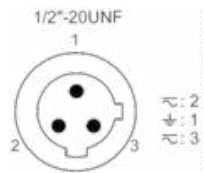

1 : Grounding

2 : AC

3 : AC

NC output

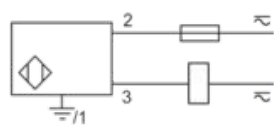

---

Performance Curves

---

Standard Steel Target : 18x18x1 mm

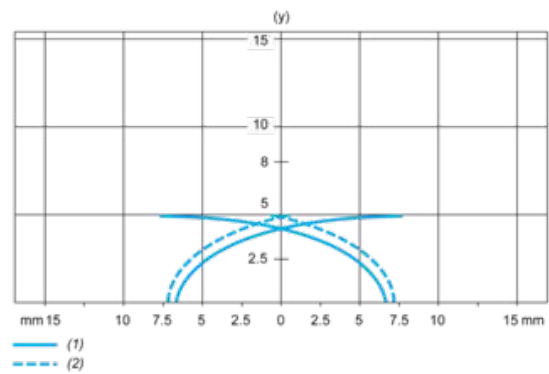

(1) Pick-up points

(2) Drop-out points (object approaching from the side)

(y) Sensing distance in mm