

# TPS6213x Buck Converter Evaluation Module User's Guide



## ABSTRACT

This user's guide describes the characteristics, operation, and use of the Texas Instruments TPS62130, TPS62140, and TPS62150 evaluation modules (EVM). These EVMs are designed to help the user easily evaluate and test the operation and functionality of the TPS62130, TPS62140, and TPS62150. This user's guide includes setup instructions for the hardware, printed-circuit board layouts for the EVMs, a schematic diagram, a bill of materials, and test results for the EVMs. After the release of the A-version devices in the summer of 2013, these EVMs are assembled with the TPS62130A, TPS62140A, or TPS62150A.

## Table of Contents

<b>1 Introduction</b> .....	3
1.1 Background.....	3
1.2 Performance Specification.....	3
1.3 Modifications.....	3
<b>2 Setup</b> .....	5
2.1 Input/Output Connector Descriptions.....	5
2.2 Setup.....	5
<b>3 TPS621x0EVM-505 Test Results</b> .....	6
<b>4 Board Layout</b> .....	16
<b>5 Schematic and Bill of Materials</b> .....	19
5.1 Schematic.....	19
5.2 Bill of Materials.....	20
<b>6 Revision History</b> .....	20

## List of Figures

Figure 1-1. Loop Response Measurement Modification.....	4
Figure 3-1. Efficiency With 1- $\mu$ H Inductor and FSW = LOW (high frequency).....	6
Figure 3-2. Efficiency With 2.2- $\mu$ H Inductor and FSW = LOW (high frequency).....	6
Figure 3-3. Efficiency With 2.2- $\mu$ H Inductor and FSW = HIGH (low frequency).....	7
Figure 3-4. Load Regulation With 2.2- $\mu$ H Inductor and FSW = LOW (high frequency).....	7
Figure 3-5. Line Regulation With 2.2- $\mu$ H Inductor and FSW = LOW (high frequency) and $I_{OUT} = 1$ A.....	8
Figure 3-6. Loop Response With 2.2- $\mu$ H Inductor and FSW = LOW (high frequency) and $V_{IN} = 12$ V and $I_{OUT} = 1$ A.....	8
Figure 3-7. Input Voltage Ripple With 2.2- $\mu$ H Inductor and FSW = LOW (high frequency) and $V_{IN} = 12$ V and $I_{OUT} = 1$ A.....	9
Figure 3-8. Output Voltage Ripple With 2.2- $\mu$ H Inductor and FSW = LOW (high frequency) and $V_{IN} = 12$ V and $I_{OUT} = 1$ A.....	9
Figure 3-9. Output Voltage Ripple With 2.2- $\mu$ H Inductor and FSW = HIGH (low frequency) and $V_{IN} = 12$ V and $I_{OUT} = 1$ A.....	10
Figure 3-10. Load Transient Response With 1- $\mu$ H Inductor and $V_{IN} = 12$ V.....	10
Figure 3-11. Load Transient Response With 2.2- $\mu$ H Inductor and $V_{IN} = 12$ V.....	11
Figure 3-12. Start-Up on EN with 1 A Load and $V_{IN} = 12$ V.....	11
Figure 3-13. Shutdown on EN with 1 A Load and $V_{IN} = 12$ V.....	12
Figure 3-14. TPS62130 Prebias Start-Up and Shutdown on EN With 1-A Load and $V_{IN} = 12$ V.....	12
Figure 3-15. TPS62130A Prebias Start-Up and Shutdown on EN With 1-A Load and $V_{IN} = 12$ V.....	13
Figure 3-16. Thermal Performance With 1- $\mu$ H Inductor and $V_{IN} = 12$ V and $I_{OUT} = 3$ A and FSW = LOW (high frequency).....	14
Figure 3-17. Thermal Performance With 2.2- $\mu$ H Inductor $V_{IN} = 12$ V and $I_{OUT} = 3$ A and FSW = HIGH (low frequency).....	15
Figure 4-1. Assembly Layer.....	16
Figure 4-2. Top Layer Routing.....	16
Figure 4-3. Internal Layer-1 Routing.....	17
Figure 4-4. Internal Layer-2 Routing.....	17
Figure 4-5. Bottom Layer Routing.....	18

Figure 5-1. TPS621x0EVM-505 Schematic.....	19
--	----

## List of Tables

Table 1-1. Performance Specification Summary.....	3
Table 5-1. TPS621x0EVM-505 Bill of Materials.....	20

## Trademarks

All trademarks are the property of their respective owners.

## 1 Introduction

The TPS62130 is a 3-A, synchronous, step-down converter in a 3x3-mm, 16-pin QFN package. Both fixed and adjustable output voltage units are available.

The TPS62140 is a 2-A, synchronous, step-down converter in a 3x3-mm, 16-pin QFN package. Both fixed and adjustable output voltage units are available.

The TPS62150 is a 1-A, synchronous, step-down converter in a 3x3-mm, 16-pin QFN package. Both fixed and adjustable output voltage units are available.

### 1.1 Background

The TPS62130EVM-505 (HPA505-001) uses the TPS62130A adjustable version and is set to a 3.3-V output. The EVM operates with full-rated performance with an input voltage between 3.7 V and 17 V.

The TPS62140EVM-505 (HPA505-002) uses the TPS62140A adjustable version and is set to a 3.3-V output. The EVM operates with full-rated performance with an input voltage between 3.7 V and 17 V.

The TPS62150EVM-505 (HPA505-003) uses the TPS62150A adjustable version and is set to a 3.3-V output. The EVM operates with full-rated performance with an input voltage between 3.7 V and 17 V.

### 1.2 Performance Specification

[Table 1-1](#) provides a summary of the TPS621x0EVM-505 performance specifications. All specifications are given for an ambient temperature of 25°C.

**Table 1-1. Performance Specification Summary**

Specification	Test Conditions	Min	Typ	Max	Unit
Input Voltage		3.7		17	V
Output Voltage	PWM Mode of Operation	3.268	3.327	3.387	V
Output Current	TPS62130EVM-505	0		3000	mA
	TPS62140EVM-505	0		2000	mA
	TPS62150EVM-505	0		1000	mA
Peak Efficiency	TPS62130EVM-505, FSW = LOW (high frequency)		93.2%		
Peak Efficiency	TPS62140EVM-505 and TPS62150EVM-505, FSW = HIGH (low frequency)		95.0%		
Soft-Start Time			1.65		ms

### 1.3 Modifications

The printed-circuit board (PCB) for this EVM is designed to accommodate both the fixed and adjustable voltage versions of this integrated circuit (IC). Additional input and output capacitors can also be added, and the soft-start time can be changed. Finally, the loop response of the IC can be measured.

#### 1.3.1 Fixed Output Operation

U1 can be replaced with the fixed-voltage version of the IC for evaluation. For fixed-voltage version operation, replace R2 with a 0-Ω resistor and remove R1.

#### 1.3.2 Input and Output Capacitors

C2 is provided for an additional input capacitor. This capacitor is not required for proper operation but can be used to reduce the input voltage ripple.

C7 is provided for an input capacitor on the AVIN pin. This capacitor is required and populated on the TPS62130EVM-505. It may be added on the other EVM versions but is not required.

C4 is provided for an additional output capacitor. This capacitor is not required for proper operation but can be used to reduce the output voltage ripple and to improve the load transient response. The total output capacitance must remain within the recommended range in the data sheet for proper operation.

### 1.3.3 Soft-Start Time

C5 controls the soft-start time of the output voltage on the TPS621x0EVM-505. It can be changed for a shorter or slower ramp up of  $V_{out}$ . Note that as the value of C5 is decreased, the inrush current increases.

### 1.3.4 Loop Response Measurement

The loop response of the TPS621x0EVM-505 can be measured with two simple changes to the circuitry. First, install a 10- $\Omega$  resistor across the pads in the middle of the back of the PCB. The pads are spaced to allow installation of 0805- or 0603-sized resistors. Second, cut the trace between the via on the output voltage and the trace that connects to the VOS pin via. These changes are shown in [Figure 1-1](#). With these changes, an ac signal (10-mV, peak-to-peak amplitude recommended) can be injected into the control loop across the added resistor.

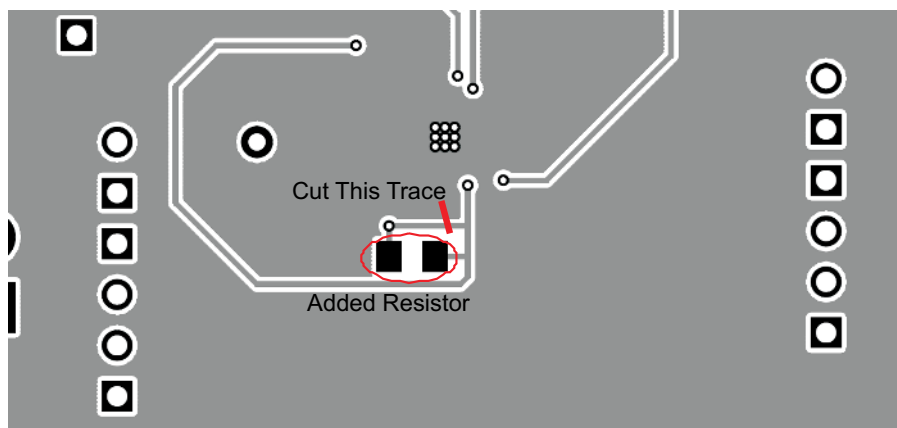

Figure 1-1. Loop Response Measurement Modification

## 2 Setup

This section describes how to properly use the TPS621x0EVM-505.

### 2.1 Input/Output Connector Descriptions

<b>J1 – VIN</b>	Positive input connection from the input supply for the EVM. Use when the steady-state input current is less than 1 A. Otherwise, use J8.
<b>J2 – S+/S–</b>	Input voltage sense connections. Measure the input voltage at this point.
<b>J3 – GND</b>	Return connection from the input supply for the EVM. Use when the steady-state input current is less than 1 A. Otherwise, use J8.
<b>J4 – VOUT</b>	Output voltage connection. Use when the steady-state output current is less than 1 A. Otherwise, use J9.
<b>J5 – S+/S–</b>	Output voltage sense connections. Measure the output voltage at this point.
<b>J6 – GND</b>	Output return connection. Use when the steady-state output current is less than 1 A. Otherwise, use J9.
<b>J7 – PG/GND</b>	The PG output appears on pin 1 of this header with a convenient ground on pin 2.
<b>J8 – VIN/GND</b>	Pin 1 is the positive input connection with pin 2, serving as the return connection. Use this terminal block if the steady-state input current is greater than 1 A.
<b>J9 – VOUT/GND</b>	Pin 2 is the output voltage connection with pin 1, serving as the output return connection. Use this terminal block if the steady-state output current is greater than 1 A.
<b>J10 – SS/TR &amp; GND</b>	The SS/TR input appears on pin 1 of this header with a convenient ground on pin 2
<b>JP1 – EN</b>	EN pin input jumper. Place the supplied jumper across ON and EN to turn on the IC. Place the jumper across OFF and EN to turn off the IC.
<b>JP2 – DEF</b>	DEF pin input jumper. Place the supplied jumper across HIGH and DEF to set the output voltage at 5% above nominal. Place the jumper across LOW and DEF to set the output voltage at the nominal level.
<b>JP3 – FSW</b>	FSW pin input jumper. Place the supplied jumper across 1.25MHz and FSW to operate the IC at a reduced switching frequency of nominally 1.25 MHz. Place the jumper across 2.5MHz and FSW to operate the IC at the full switching frequency of nominally 2.5 MHz.
<b>JP4 – PG Pullup Voltage</b>	PG pin pullup voltage jumper. Place the supplied jumper on JP4 to connect the PG pin pullup resistor to Vout. Alternatively, the jumper can be removed and a different voltage can be supplied on pin 2 to pull up the PG pin to a different level. This externally applied voltage must remain below 7 V.

### 2.2 Setup

To operate the EVM, set jumpers JP1 through JP4 to the desired positions per [Section 2.1](#). Connect the input supply to either J1 and J3 or J8, and connect the load to either J4 and J6 or J9.

### 3 TPS621x0EVM-505 Test Results

This section provides test results of the TPS621x0EVM-505.

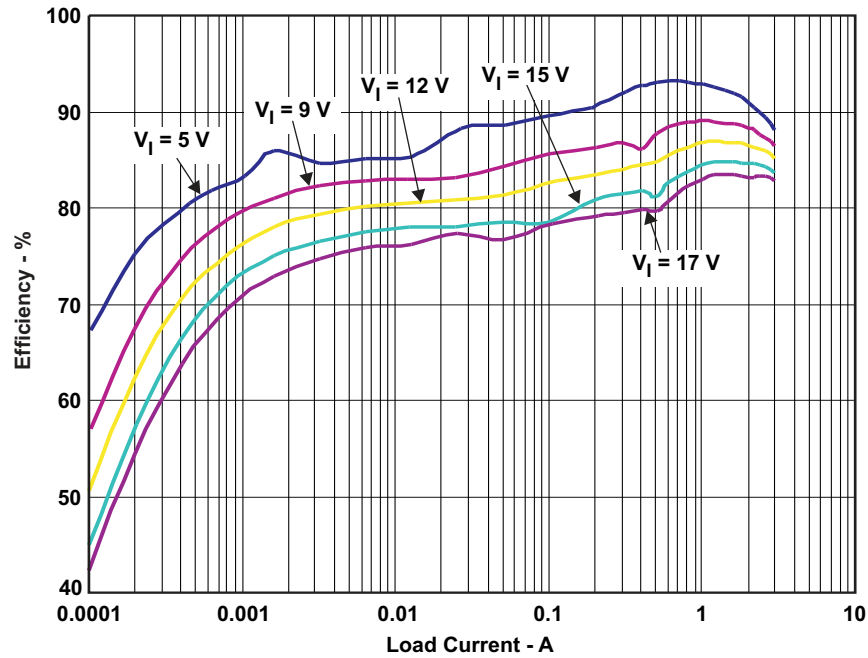

Figure 3-1. Efficiency With 1- $\mu$ H Inductor and FSW = LOW (high frequency)

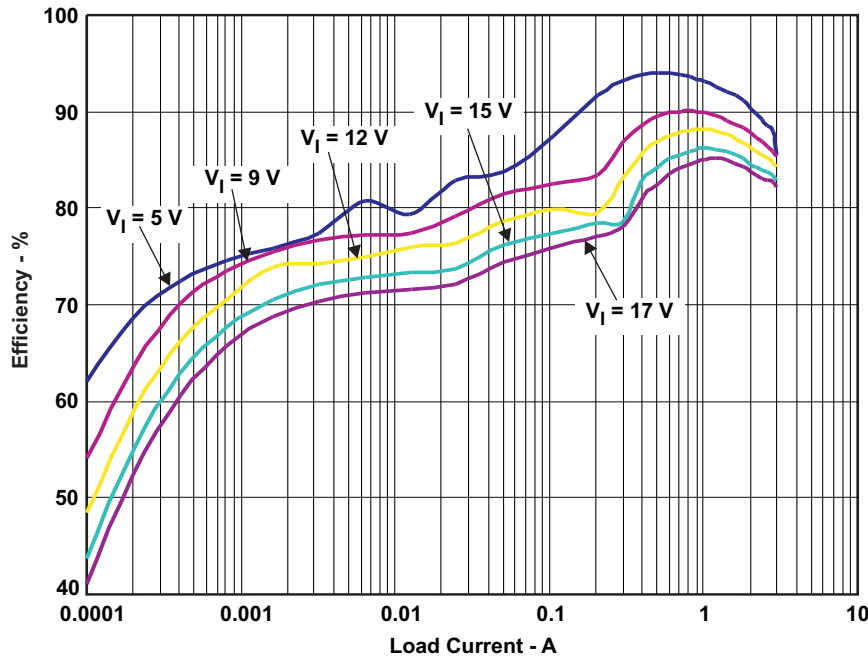

Figure 3-2. Efficiency With 2.2- $\mu$ H Inductor and FSW = LOW (high frequency)

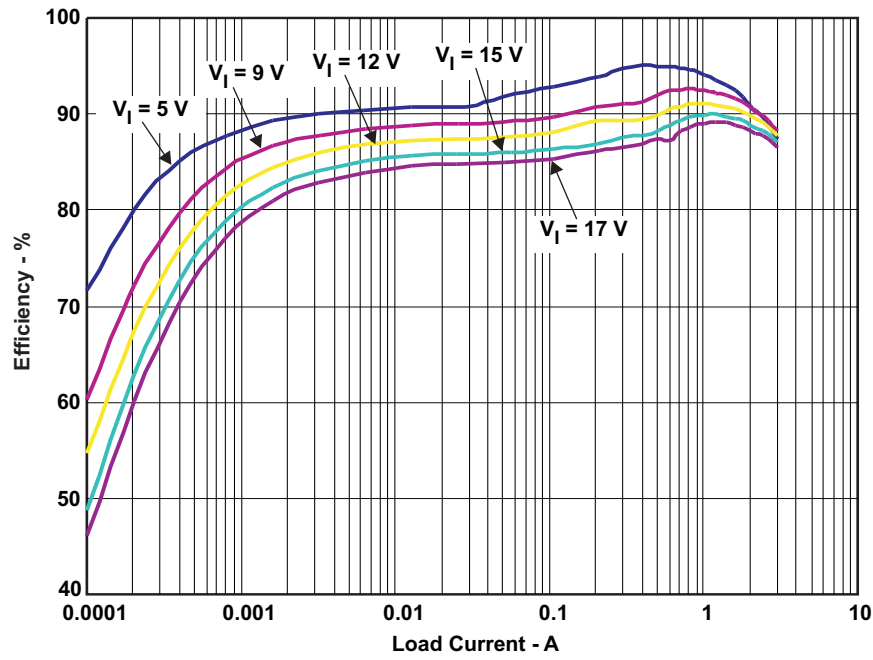

Figure 3-3. Efficiency With 2.2- $\mu\text{H}$  Inductor and FSW = HIGH (low frequency)

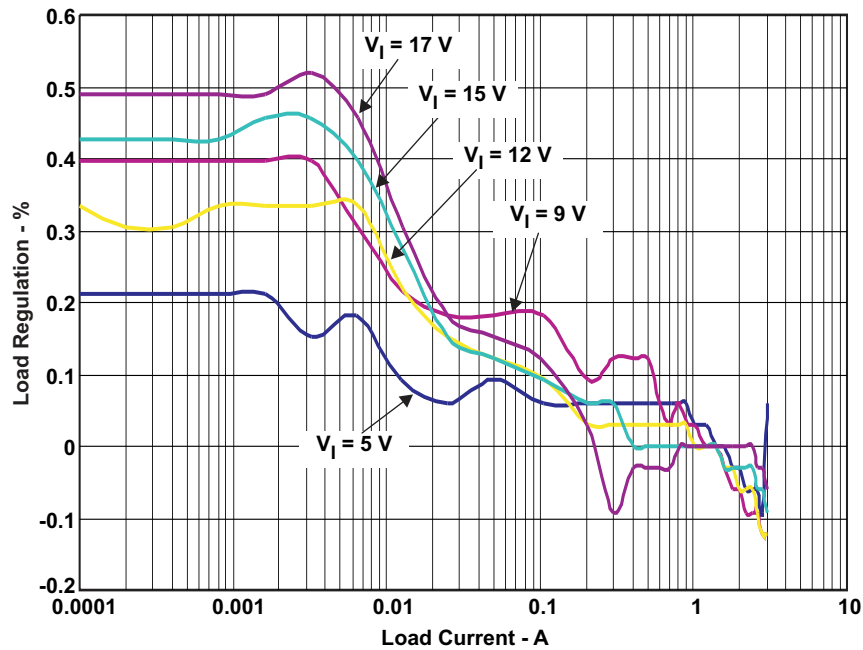

Figure 3-4. Load Regulation With 2.2- $\mu\text{H}$  Inductor and FSW = LOW (high frequency)

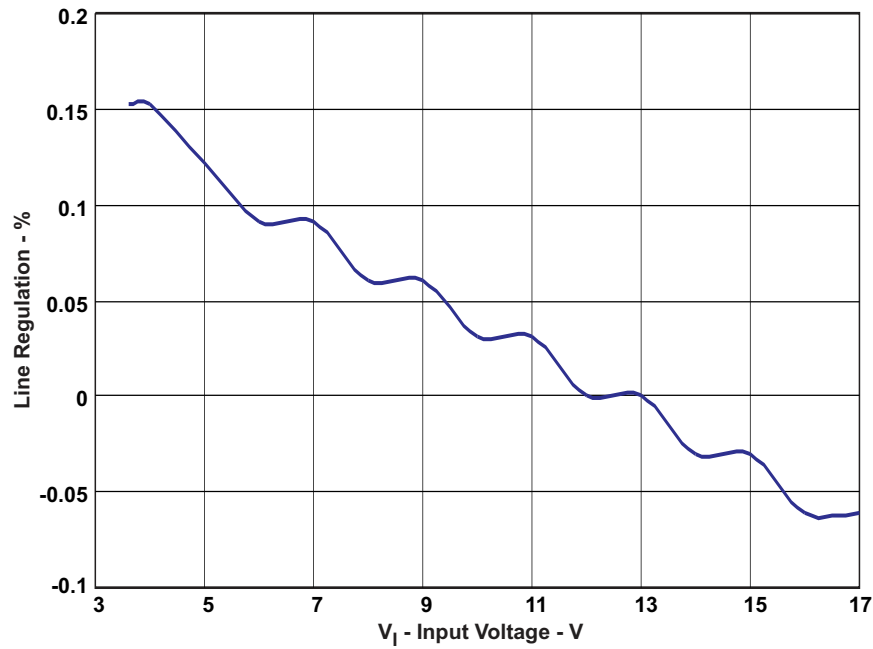

Figure 3-5. Line Regulation With 2.2- $\mu$ H Inductor and FSW = LOW (high frequency) and  $I_{OUT} = 1$  A

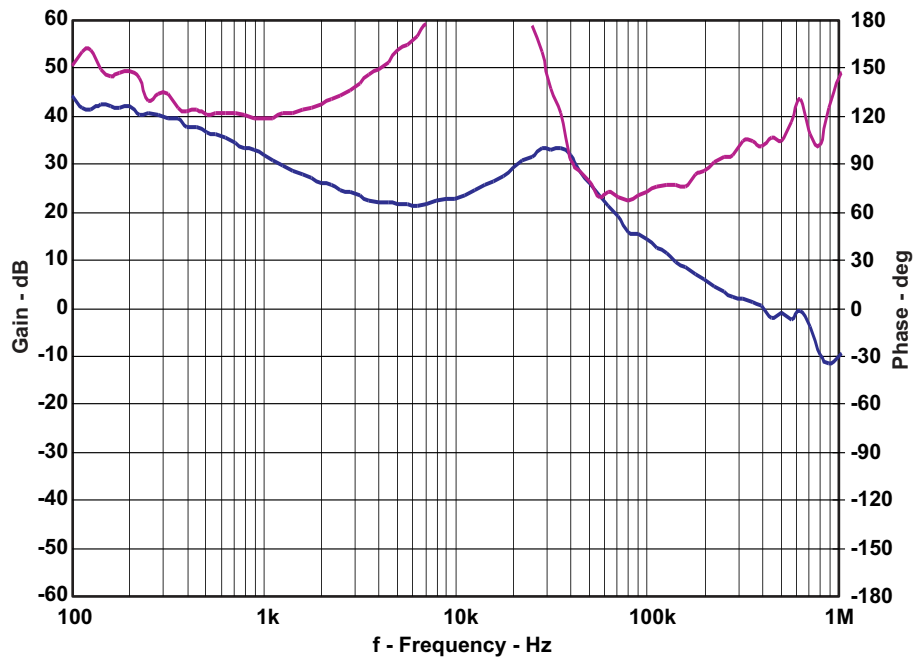

Figure 3-6. Loop Response With 2.2- $\mu$ H Inductor and FSW = LOW (high frequency) and  $V_{IN} = 12$  V and  $I_{OUT} = 1$  A



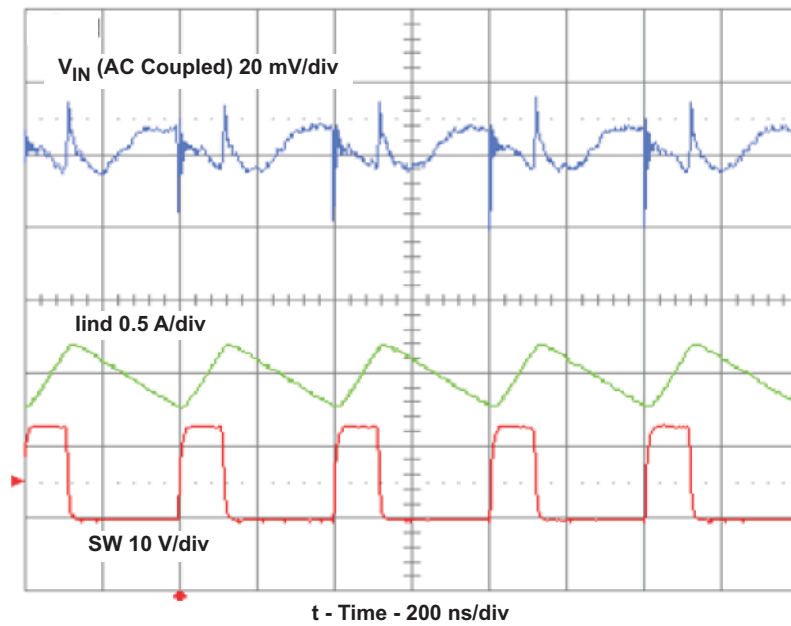

Figure 3-7. Input Voltage Ripple With 2.2- $\mu$ H Inductor and FSW = LOW (high frequency) and  $V_{in}$  = 12 V and  $I_{out}$  = 1 A

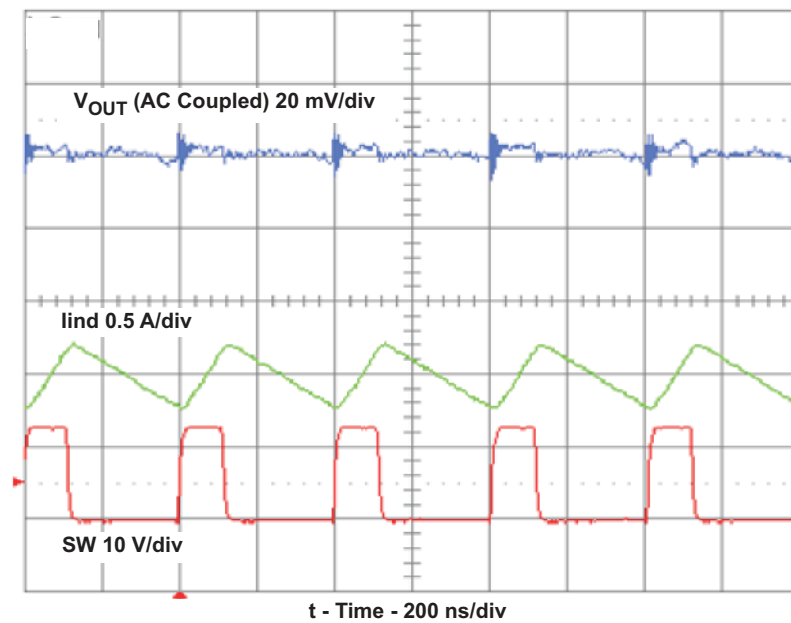

Figure 3-8. Output Voltage Ripple With 2.2- $\mu$ H Inductor and FSW = LOW (high frequency) and  $V_{in}$  = 12 V and  $I_{out}$  = 1 A

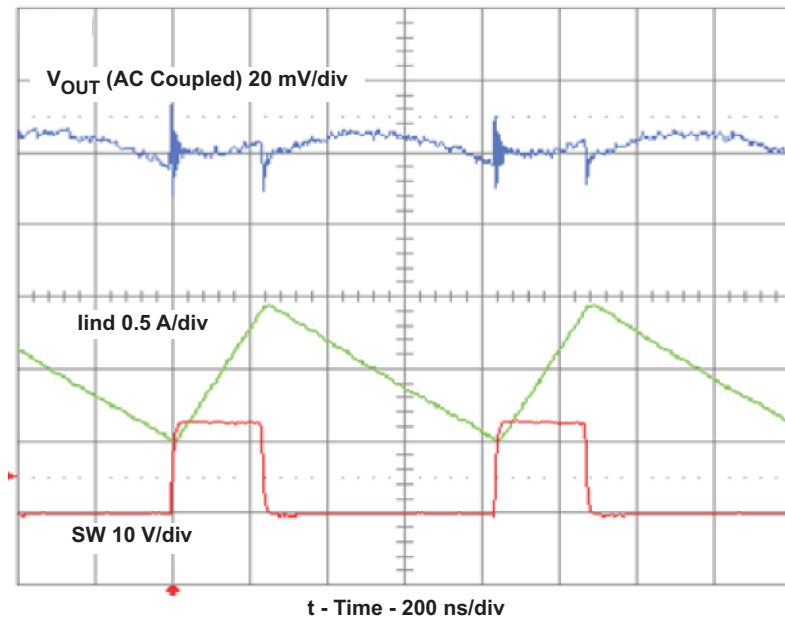

Figure 3-9. Output Voltage Ripple With 2.2- $\mu$ H Inductor and FSW = HIGH (low frequency) and  $V_{in}$  = 12 V and  $I_{out}$  = 1 A

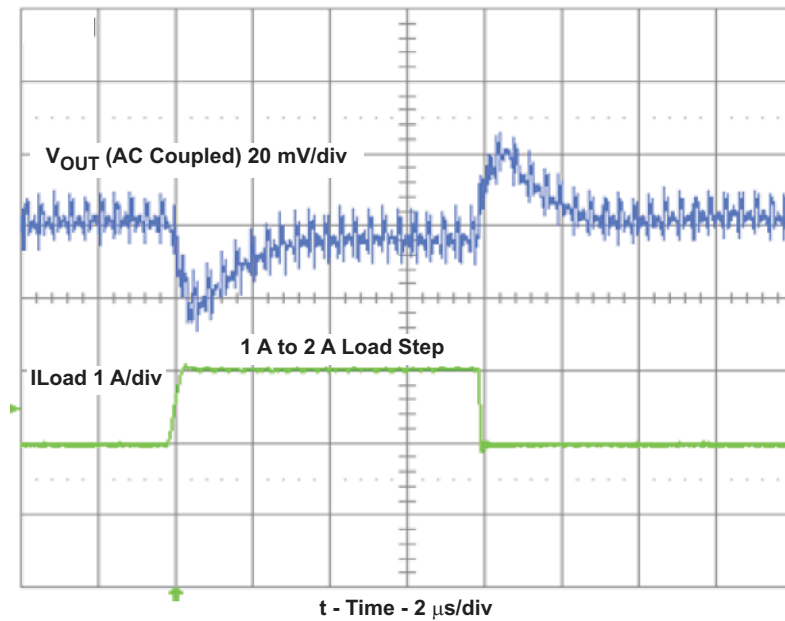

Figure 3-10. Load Transient Response With 1- $\mu$ H Inductor and  $V_{in}$  = 12 V

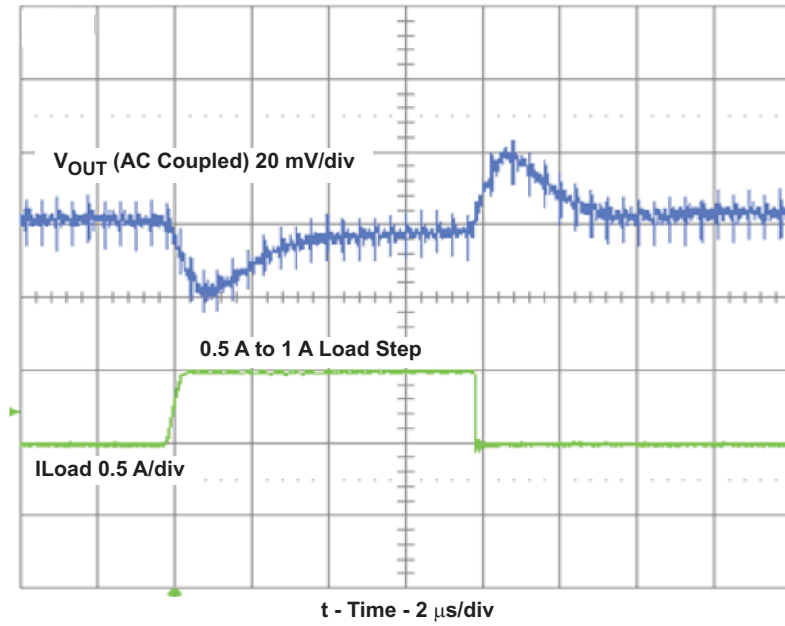

Figure 3-11. Load Transient Response With 2.2-μH Inductor and Vin = 12 V

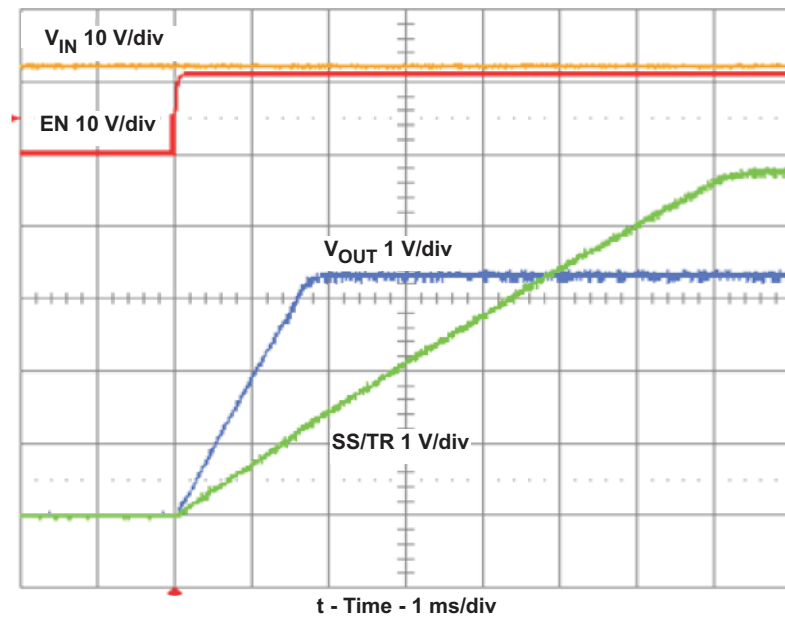
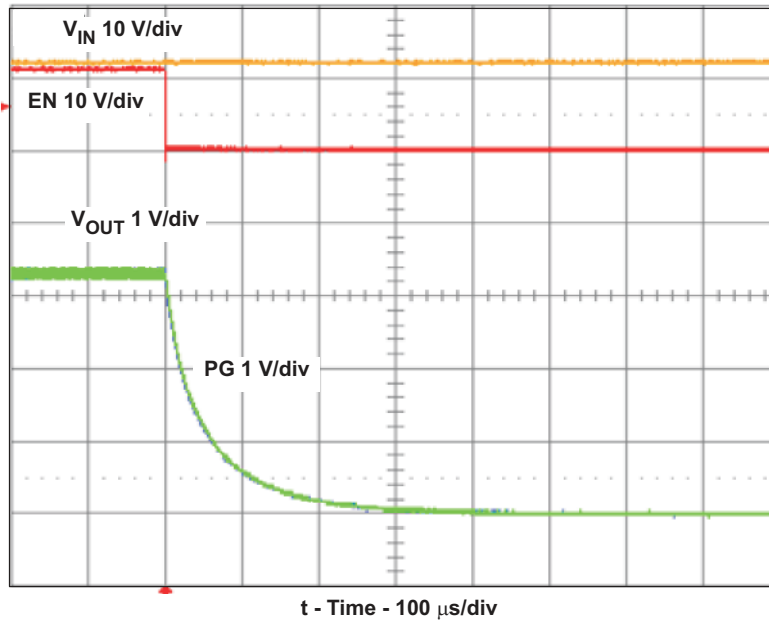
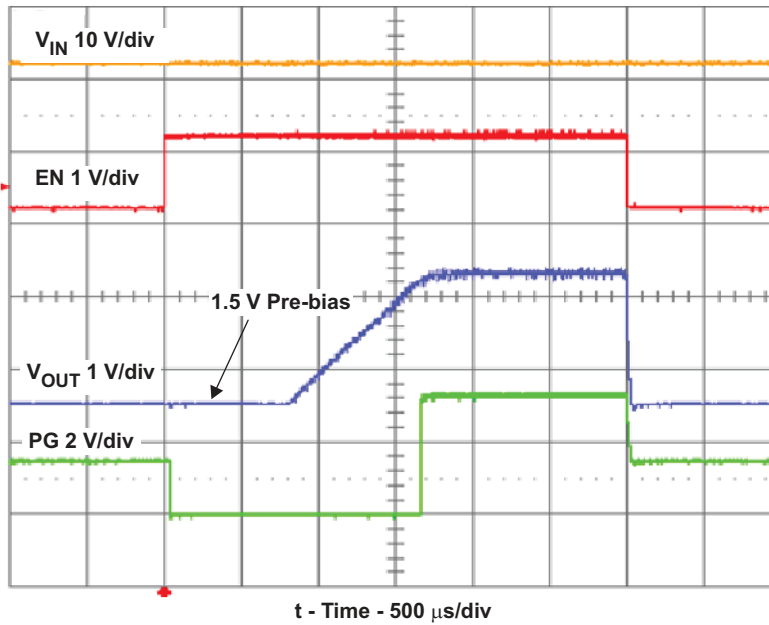

Figure 3-12. Start-Up on EN with 1 A Load and Vin = 12 V



**Figure 3-13. Shutdown on EN with 1 A Load and Vin = 12 V**



**Figure 3-14. TPS62130 Prebias Start-Up and Shutdown on EN With 1-A Load and Vin = 12 V**

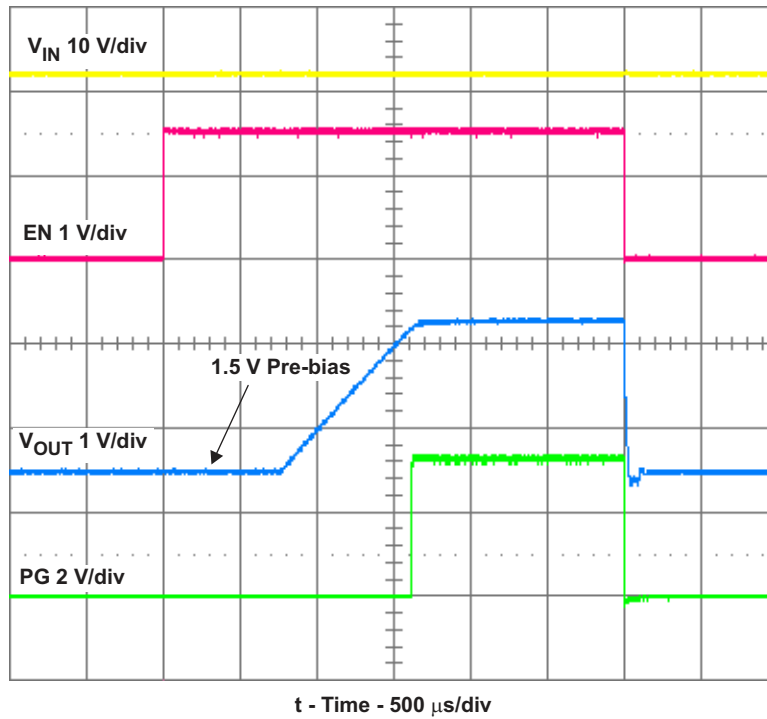

**Figure 3-15. TPS62130A Prebias Start-Up and Shutdown on EN With 1-A Load and Vin = 12 V**

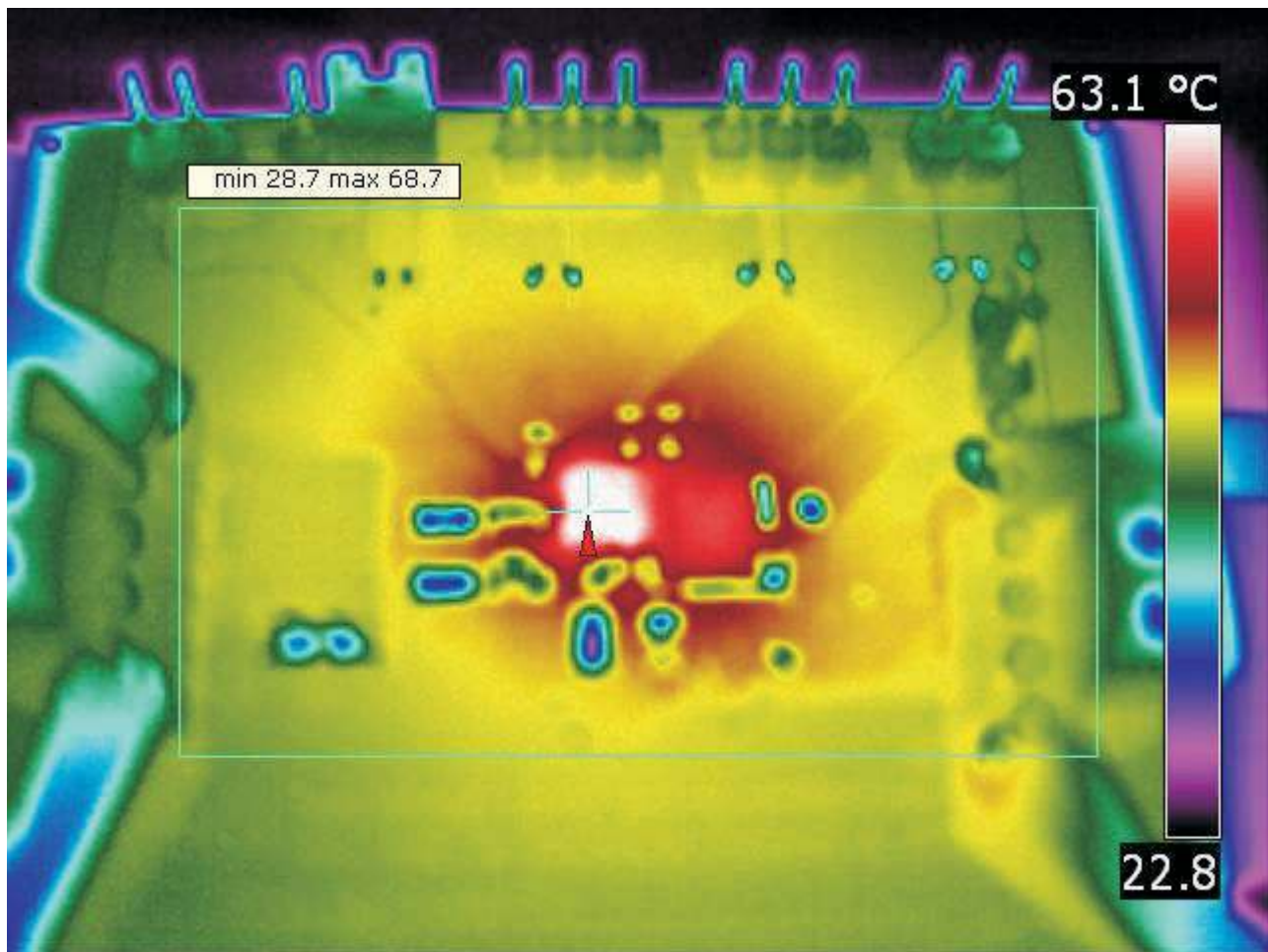

Figure 3-16. Thermal Performance With 1- $\mu$ H Inductor and  $V_{in} = 12$  V and  $I_{out} = 3$  A and FSW = LOW (high frequency)

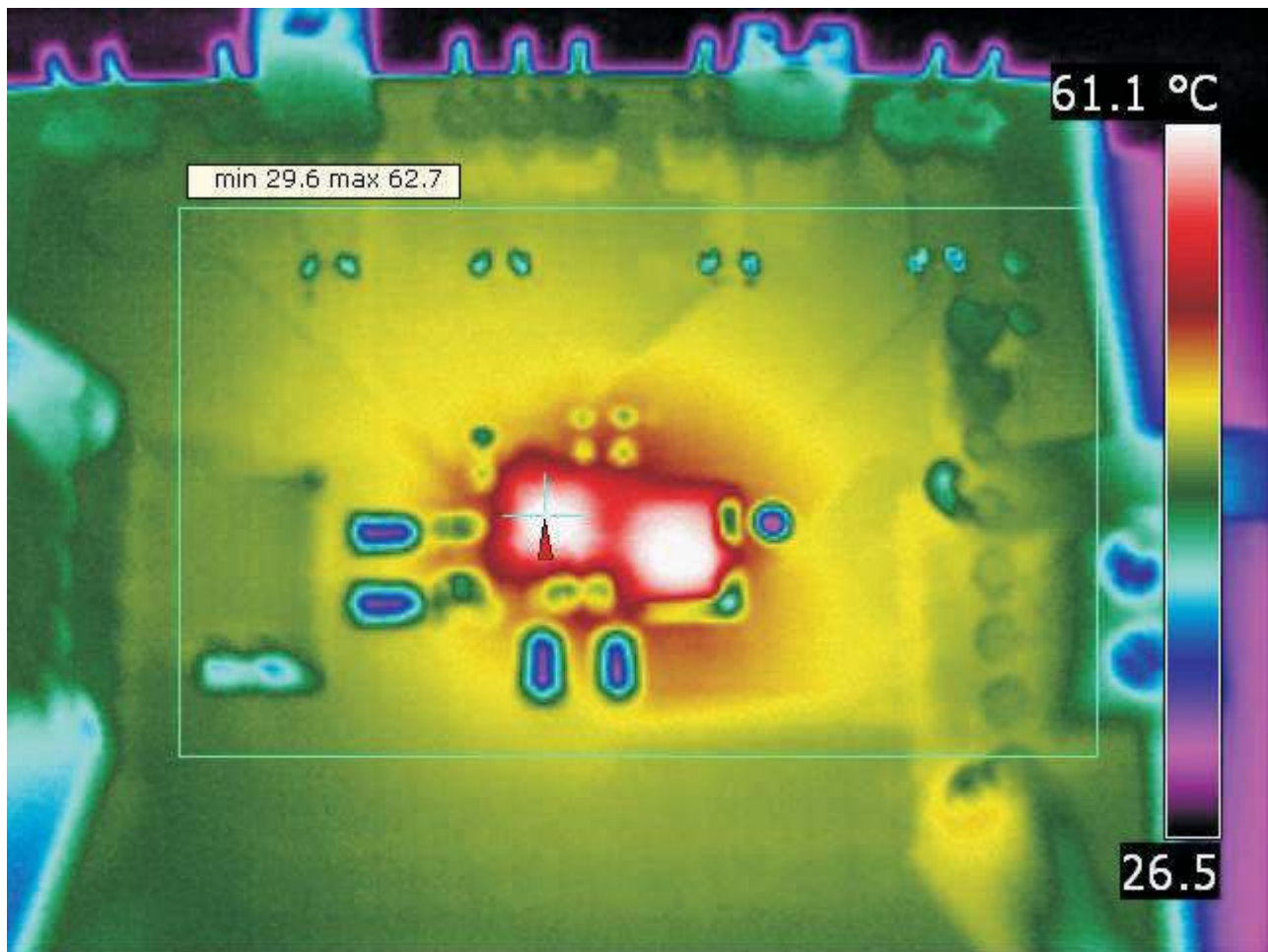

Figure 3-17. Thermal Performance With 2.2- $\mu$ H Inductor  $V_{in} = 12$  V and  $I_{out} = 3$  A and FSW = HIGH (low frequency)

## 4 Board Layout

This section provides the TPS621x0EVM-505 board layout and illustrations.

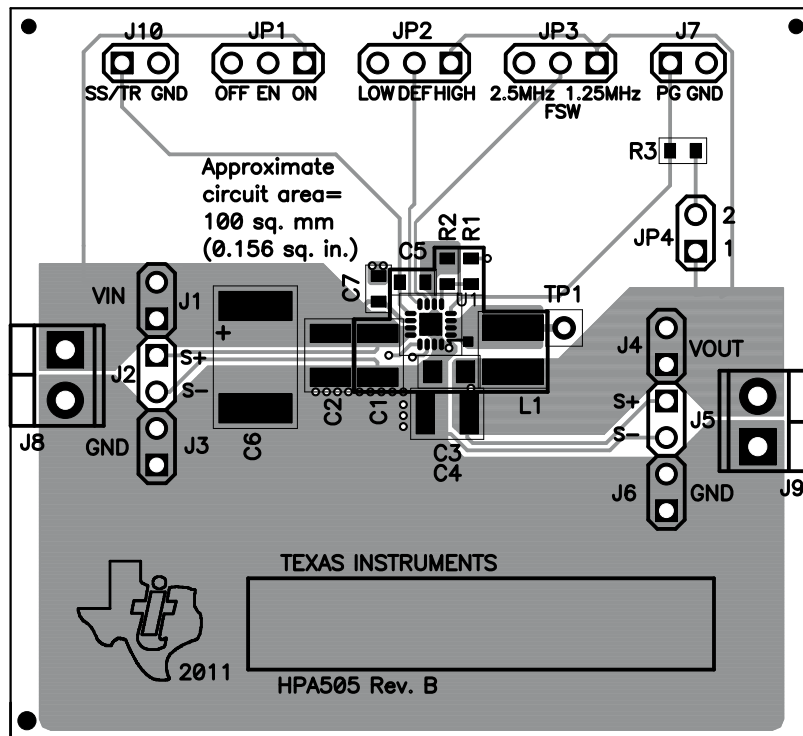

Figure 4-1. Assembly Layer

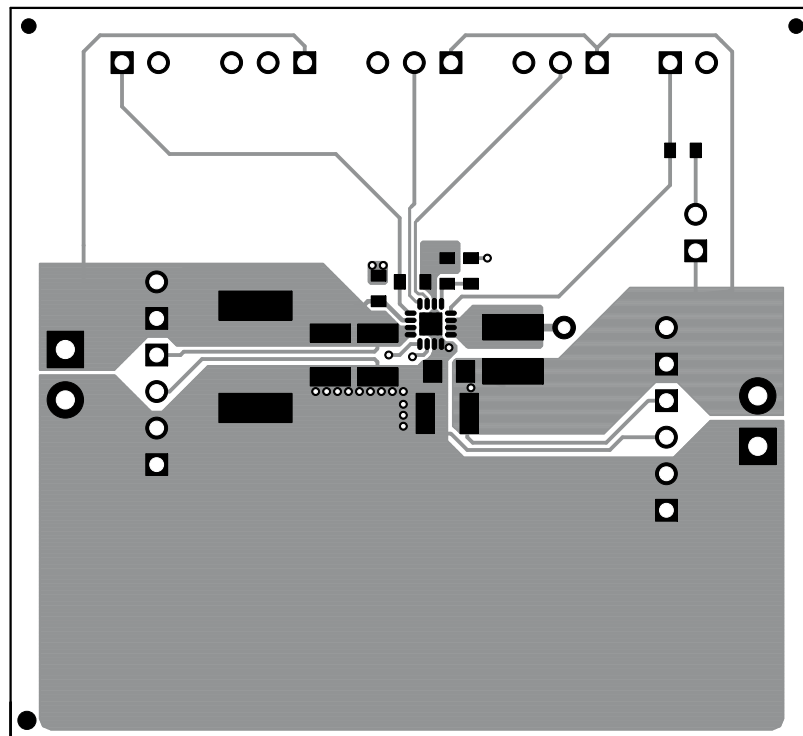

Figure 4-2. Top Layer Routing



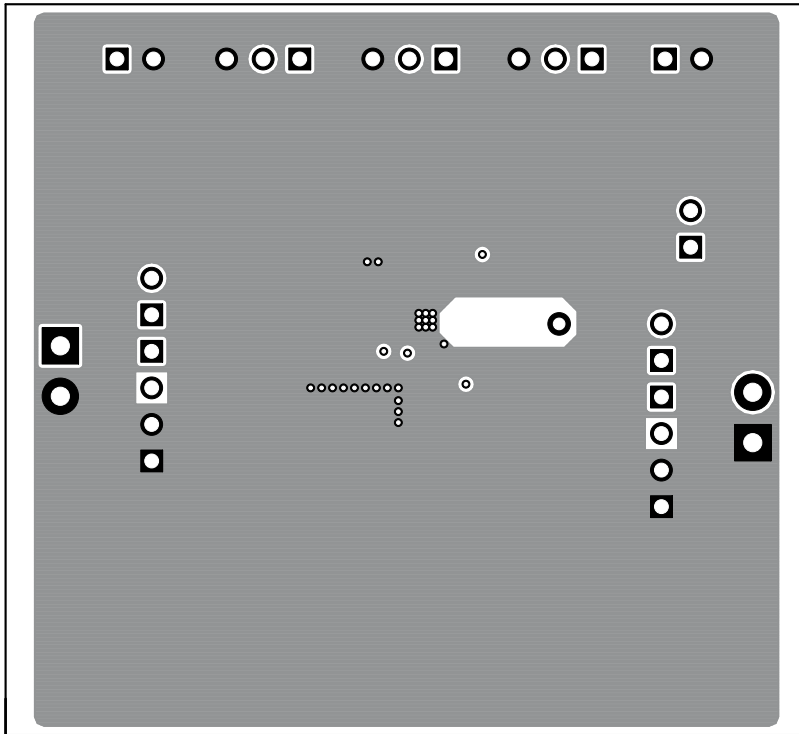

Figure 4-3. Internal Layer-1 Routing

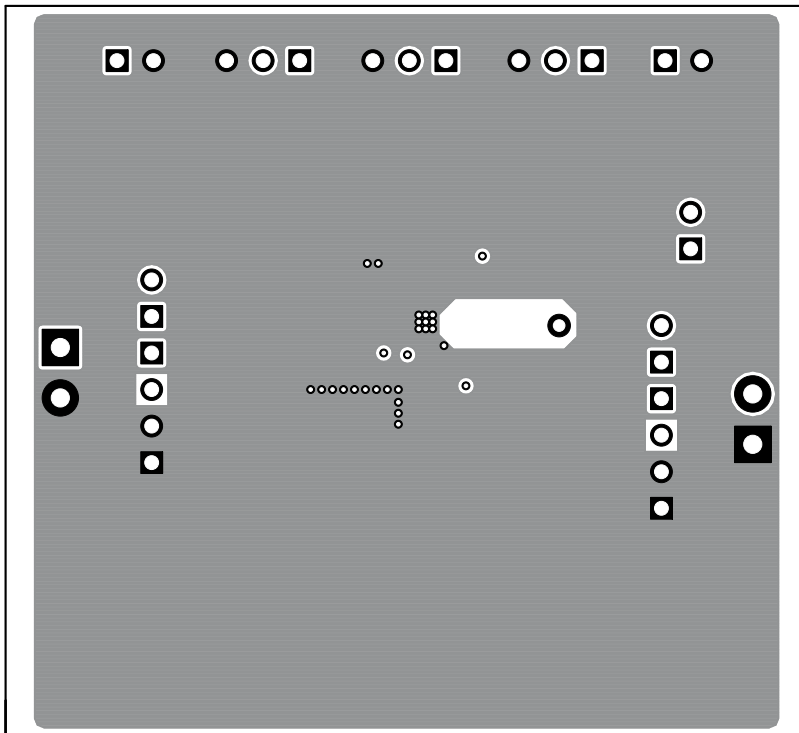
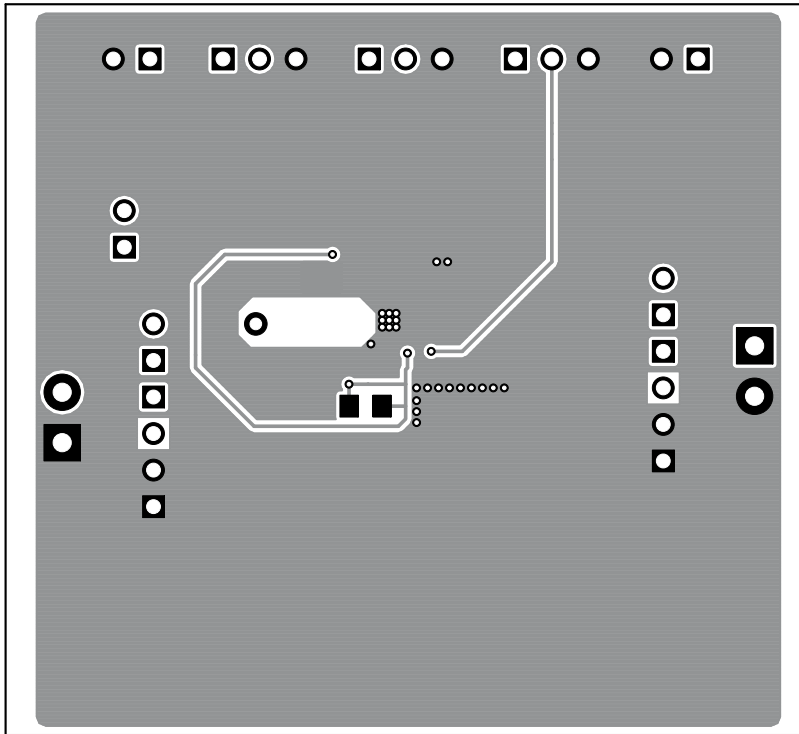

Figure 4-4. Internal Layer-2 Routing

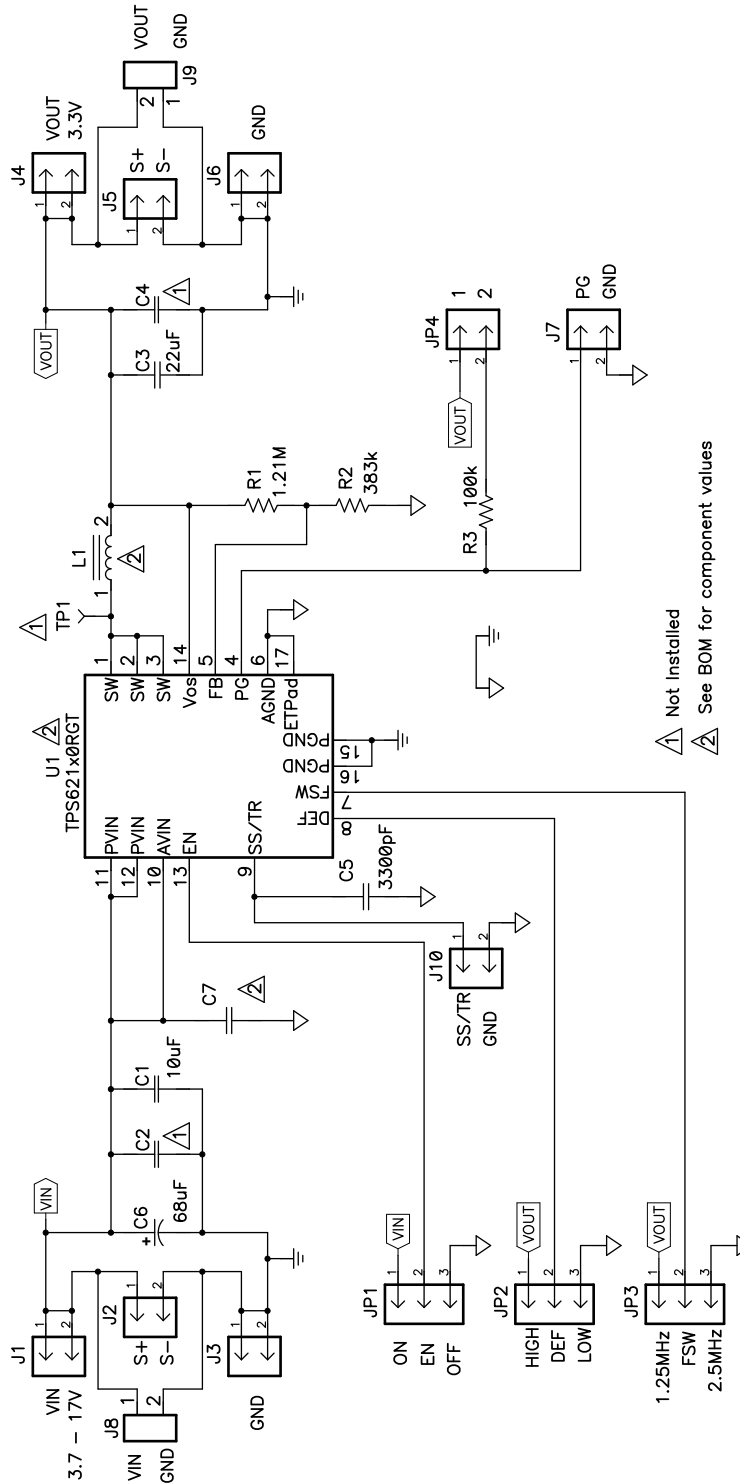

**Figure 4-5. Bottom Layer Routing**

## 5 Schematic and Bill of Materials

This section provides the TPS621x0EVM-505 schematic and bill of materials.

### 5.1 Schematic



**Figure 5-1. TPS621x0EVM-505 Schematic**

## 5.2 Bill of Materials

**Table 5-1. TPS621x0EVM-505 Bill of Materials**

Count			RefDes	Value	Description	Size	Part Number	MFR
-001	-002	-003						
1	1	1	C1	10 $\mu$ F	Capacitor, Ceramic, 25V, X5R, 20%	1210	Std	Std
1	1	1	C3	22 $\mu$ F	Capacitor, Ceramic, 6.3V, X5R, 20%	0805	Std	Std
1	1	1	C5	3300 pF	Capacitor, Ceramic, 25V, X7R, 10%	0603	Std	Std
1	1	1	C6	68 $\mu$ F	Capacitor, Tantalum, 35V, 68uF, $\pm$ 20%	7361[V]	TPSV686M035R0150	AVX
1	0	0	C7	0.1 $\mu$ F	Capacitor, Ceramic, 25V, X5R, 20%	0603	Std	Std
1	0	0	L1	1.0 $\mu$ H	Inductor, Power, 5.1A, $\pm$ 20%	0.165 x 0.165 inch	XFL4020-102ME	Coilcraft
0	1	1	L1	2.2 $\mu$ H	Inductor, Power, 3.5A, $\pm$ 20%	0.165 x 0.165 inch	XFL4020-222ME	Coilcraft
1	1	1	R1	1.21M	Resistor, Chip, 1/16W, 1%	0603	Std	Std
1	1	1	R2	383k	Resistor, Chip, 1/16W, 1%	0603	Std	Std
1	1	1	R3	100k	Resistor, Chip, 1/16W, 1%	0603	Std	Std
1	0	0	U1 <sup>(1)</sup>	TPS62130ARGT	IC, 17V 3A Step-Down Converter in 3 mm x 3 mm QFN Package	3 x 3 mm QFN	TPS62130ARGT	TI
0	1	0	U1 <sup>(1)</sup>	TPS62140ARGT	IC, 17V 2A Step-Down Converter in 3 mm x 3 mm QFN Package	3 x 3 mm QFN	TPS62140ARGT	TI
0	0	1	U1 <sup>(1)</sup>	TPS62150ARGT	IC, 17V 1A Step-Down Converter in 3 mm x 3 mm QFN Package	3 x 3 mm QFN	TPS62150ARGT	TI

- (1) EVMs made before August of 2013 use the non-A version of U1. The only difference between these devices is the operation of the PG pin when the device is disabled, as shown in [Figure 3-14](#) and [Figure 3-15](#).

## 6 Revision History

NOTE: Page numbers for previous revisions may differ from page numbers in the current version.

Changes from Revision A (July 2013) to Revision B (June 2021)	Page
• Updated the numbering format for tables, figures, and cross-references throughout the document. ....	3
• Updated user's guide title.....	3

## IMPORTANT NOTICE AND DISCLAIMER

TI PROVIDES TECHNICAL AND RELIABILITY DATA (INCLUDING DATA SHEETS), DESIGN RESOURCES (INCLUDING REFERENCE DESIGNS), APPLICATION OR OTHER DESIGN ADVICE, WEB TOOLS, SAFETY INFORMATION, AND OTHER RESOURCES "AS IS" AND WITH ALL FAULTS, AND DISCLAIMS ALL WARRANTIES, EXPRESS AND IMPLIED, INCLUDING WITHOUT LIMITATION ANY IMPLIED WARRANTIES OF MERCHANTABILITY, FITNESS FOR A PARTICULAR PURPOSE OR NON-INFRINGEMENT OF THIRD PARTY INTELLECTUAL PROPERTY RIGHTS.

These resources are intended for skilled developers designing with TI products. You are solely responsible for (1) selecting the appropriate TI products for your application, (2) designing, validating and testing your application, and (3) ensuring your application meets applicable standards, and any other safety, security, regulatory or other requirements.

These resources are subject to change without notice. TI grants you permission to use these resources only for development of an application that uses the TI products described in the resource. Other reproduction and display of these resources is prohibited. No license is granted to any other TI intellectual property right or to any third party intellectual property right. TI disclaims responsibility for, and you will fully indemnify TI and its representatives against, any claims, damages, costs, losses, and liabilities arising out of your use of these resources.

TI's products are provided subject to [TI's Terms of Sale](#) or other applicable terms available either on [ti.com](http://ti.com) or provided in conjunction with such TI products. TI's provision of these resources does not expand or otherwise alter TI's applicable warranties or warranty disclaimers for TI products.

TI objects to and rejects any additional or different terms you may have proposed.

Mailing Address: Texas Instruments, Post Office Box 655303, Dallas, Texas 75265  
Copyright © 2022, Texas Instruments Incorporated